

**DAIKIN**

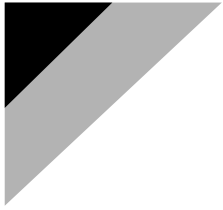

# OPERATION MANUAL

---

## SPLIT SYSTEM Air Conditioners

---

### MODELS

Ceiling-mounted Cassette type (Multi flow model)

**FCQ24MVJU**

**FCQ30MVJU**

**FCQ36MVJU**

**FCQ42MVJU**

Read these instructions carefully before installation.  
Keep this manual in a handy place for future reference.  
This manual should be left with the equipment owner.



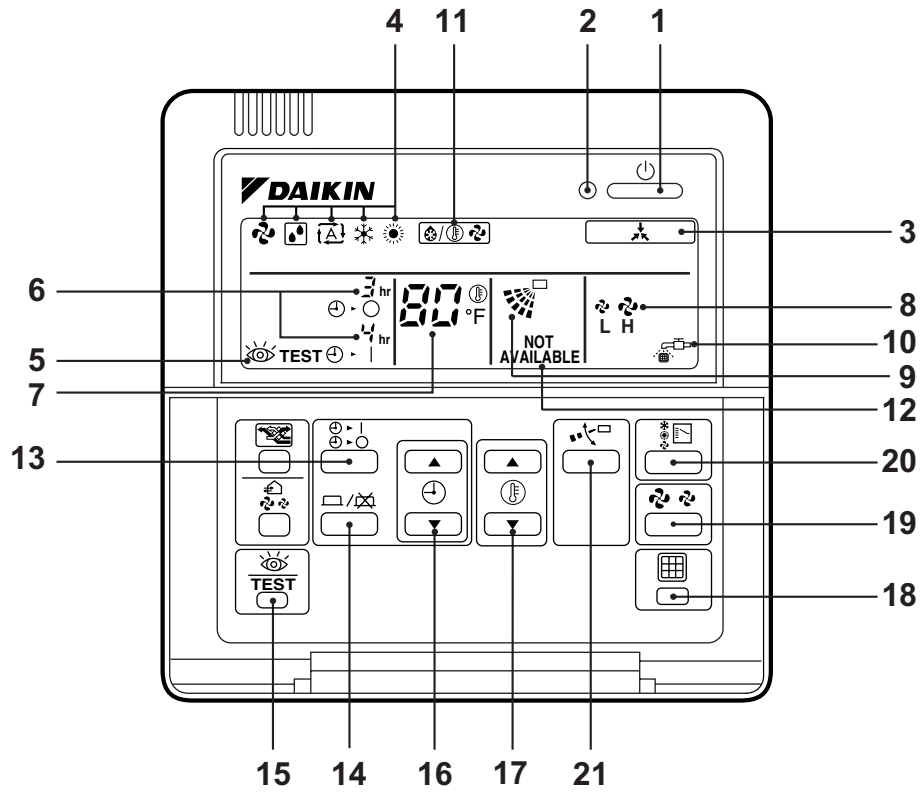

1

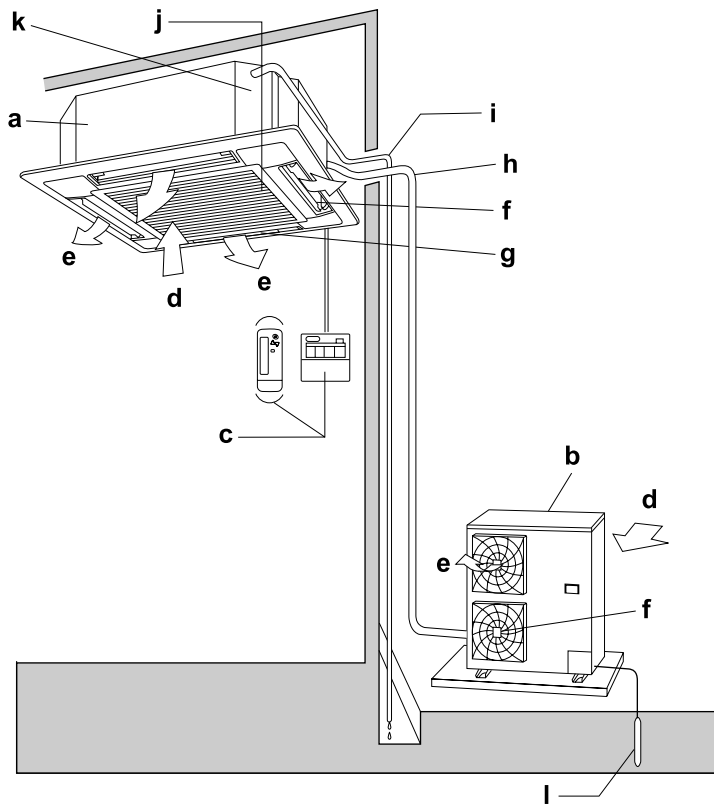

2

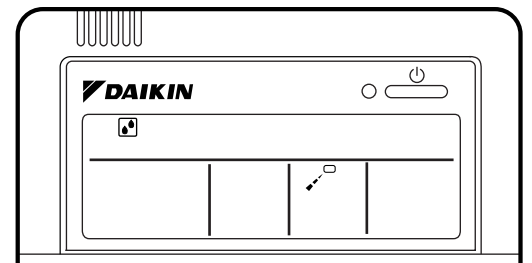

3

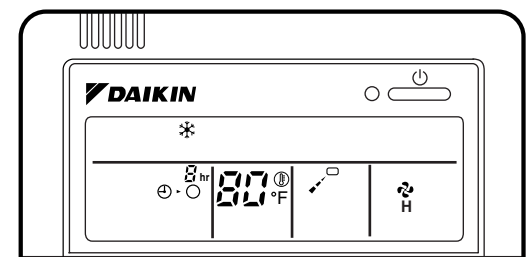

4

3

# CONTENTS

ILLUSTRATIONS ..... 3

1. WHAT TO DO BEFORE OPERATION ..... 4

2. SAFETY CONSIDERATIONS..... 4

3. OPERATION RANGE ..... 7

4. INSTALLATION SITE..... 7

5. NAME AND FUNCTION OF EACH SWITCH AND DISPLAY ON THE REMOTE CONTROLLER ..... 8

6. OPERATION PROCEDURE ..... 8

7. OPTIMUM OPERATION ..... 11

8. MAINTENANCE (FOR SERVICE PERSONNEL)..... 11

9. NOT MALFUNCTION OF THE AIR CONDITIONER..... 13

10. TROUBLE SHOOTING..... 14

## 1. WHAT TO DO BEFORE OPERATION

This operation manual is for the following system with standard control. Before initiating operation, contact your dealer for the operation that corresponds to your system.

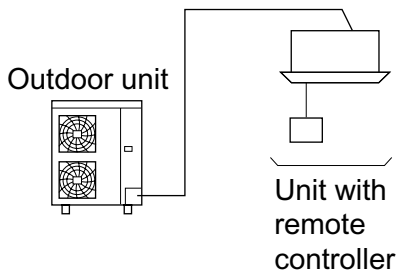

### NOTE

- If the unit you purchased is controlled by a wireless remote controller, also refer to the wireless remote controller’s operation manual. If your installation has a customized control system, ask your dealer for the operation that corresponds to your system.

### TWO REMOTE CONTROLLERS CONTROL SYSTEM

Confirm the following if your unit is the following control system type.

- **Two remote controllers control system**  
Two remote controllers control one indoor unit. The unit is individually operated.

### NOTE

- Contact your dealer in case of two remote controllers control system.

### Names and functions of parts

Refer to figure 2 on page 3

<b>a</b>	Indoor unit
<b>b</b>	Outdoor unit
<b>c</b>	Remote controller
<b>d</b>	Inlet air
<b>e</b>	Discharge air
<b>f</b>	Air outlet
<b>g</b>	Air flow flap (at air outlet)
<b>h</b>	Refrigerant pipe, connection electric wire
<b>i</b>	Drain pipe
<b>j</b>	Air inlet The built-in air filter removes dust and dirt.
<b>k</b>	Drain pumping out device (built-in) Condensate removed from the room during cooling.
<b>l</b>	Ground wire Wire to ground from the outdoor unit to prevent electrical shocks.

## 2. SAFETY CONSIDERATIONS

Please read these “SAFETY CONSIDERATIONS” carefully before installing air conditioning equipment and be sure to install it correctly. After completing the installation, make sure that the unit operates properly during the start-up operation. Please instruct the customer on how to operate the unit and keep it maintained. Also, inform customers that they should store this operation manual along with the installation manual for future reference.

This air conditioner comes under the term “appliances not accessible to the general public”.

Meaning of danger, warning, caution and note symbols.

- ⚠ **DANGER**..... Indicates an imminently hazardous situation which, if not avoided, will result in death or serious injury.

**⚠ WARNING**... Indicates a potentially hazardous situation which, if not avoided, could result in death or serious injury.

**⚠ CAUTION**.... Indicates a potentially hazardous situation which, if not avoided, may result in minor or moderate injury. It may also be used to alert against unsafe practices.

**⚠ NOTE** ..... Indicates situation that may result in equipment or property-damage-only accidents.

**Keep these warning sheets handy so that you can refer to them if needed.**

Also, if this equipment is transferred to a new user, make sure to hand over this operation manual to the new user.

---

**⚠ DANGER**

---

- **Do not install the unit in an area where flammable materials are present due to risk of explosion resulting in serious injury or death.**
- **Any abnormalities in the operation of the air conditioner such as smoke or fire could result in severe injury or death.**

Turn off the power and contact your dealer immediately for instructions.

- **Refrigerant gas may product toxic gas if it comes in contact with fire such a from a fan, heater, stove or cooking device. Exposure to this gas could cause severe injury or death.**
- **For refrigerant leakage, consult your dealer.** Refrigerant gas is heavier than air and replaces oxygen. A massive leak could lead to oxygen depletion, especially in basements, and an asphyxiation hazard could occur leading to serious injury or death.
- **If equipment utilizing a burner is used in the same room as the air conditioner, there is the danger of oxygen deficiency which could lead to an asphyxiation hazard resulting in serious injury or death.**

Be sure to ventilate the room sufficiently to avoid this hazard.

- **Safely dispose of the packing materials.** Packing materials, such as nails and other metal or wooden parts, may cause stabs or other injuries. Tear apart and throw away plastic packaging bags so that children will not play with them. Children playing with plastic bags face the danger of death by suffocation.
- 

---

**⚠ WARNING**

---

- **It is not good for your health to expose your body to the air flow for a long time.**
- **Ask your dealer for installation of the air conditioner.**

Incomplete installation performed by yourself may result in a water leakage, electric shock, and fire.

- **Ask your dealer for improvement, repair, and maintenance.** Incomplete improvement, repair, and maintenance may result in a water leakage, electric shock, and fire.
- **Improper installation or attachment of equipment or accessories could result in electric shock, short-circuit, leaks, fire or other damage to the equipment. Be sure only to use accessories made by Daikin which are specifically designed for use with the equipment and have them installed by a professional.**
- **Ask your dealer to move and reinstall the air conditioner.**

Incomplete installation may result in a water leakage, electric shock, and fire.

- **Never let the indoor unit or the remote controller get wet.**

It may cause an electric shock or a fire.

- **Never use flammable spray such as hair spray, lacquer or paint near the unit.** It may cause a fire.
- **Never replace a fuse with that of wrong ampere ratings or other wires when a fuse blows out.**

Use of wire or copper wire may cause the unit to break down or cause a fire.

- **Never remove the fan guard of the unit.** A fan rotating at high speed without the fan guard is very dangerous.
- **Never inspect or service the unit by yourself.** Ask a qualified service person to perform this work.
- **Cut off all electric power supply before maintenance.**
- **To avoid the risk of serious electrical shock, never sprinkle or spill water or liquids on the unit.**
- **Do not install the air conditioner at any place where flammable gas may leak out.** If the gas leaks out and stays around the air conditioner, a fire may break out.
- **Operating the air conditioner with wet hands could result in a shock hazard.**

- **Check the unit stand for damage on a continuous basis.**  
If left in a damaged condition the unit may fall and cause injury.
- **Do not allow children to play on or around the unit as they could be injured.**
- **Placing a flower vase or other containers with water or other liquids on the unit could result in a shock hazard or fire if a spill occurs.**
- **Do not put a finger or other objects into the air inlet or air outlet.**  
The fan is rotating at high speed and will cause injury.
- **The heat exchanger fins are sharp enough to cut. To avoid injury wear gloves or cover the fins while working around them.**  
Do not touch the air outlet or the horizontal flaps while the swing flap is in operation as fingers may get caught and injured.
- **Be sure to establish an earth.**  
Do not earth the unit to a utility pipe, arrester, or telephone earth.  
Incomplete earth may cause electrical shock, or fire.  
A high surge current from lightning or other sources may cause damage to the air conditioner.
- **Be sure to install an earth leakage breaker.**  
Failure to install an earth leakage breaker may result in electric shocks, or fire.
- **Never touch the internal parts of the controller.**  
Do not remove the front panel because some parts inside are dangerous to touch. In addition, some parts may be damaged. For checking and adjusting internal parts, contact your dealer.
- **Do not touch the air outlet or horizontal blades while the swing flap is in operation because fingers could get caught and injured.**

---

**⚠ CAUTION**

- **Do not use the air conditioner for other purposes.**  
In order to avoid any quality deterioration, do not use the unit for cooling precision instruments, food, plants, animals or works of art.
- **Do not place items under the indoor unit which may be damaged by water.**  
Condensation may form if the humidity is above 80% or if the drain outlet gets blocked.

- **Avoid placing the controller in a spot splashed with water.**  
Water coming inside the air conditioner may cause an electric leak or may damage the internal electronic parts.
  - **Do not operate the air conditioner when using a room fumigation - type insecticide.**  
Failure to observe could cause the chemicals to become deposited in the unit, which could endanger the health of those who are hypersensitive to chemicals.
  - **Do not turn off the power immediately after stopping operation.**  
Always wait at least 5 minutes before turning off the power. Otherwise, water leakage and trouble may occur.
  - **The appliance is not intended for use by young children or infirm persons without supervision.**
  - **The remote controller should be installed in such away that children cannot play with it.**
  - **Consult with installation contractor for cleaning the inside of the air conditioner.**  
Wrong cleaning may make the plastics parts broken or cause failure of water leakage or electric shock.
  - **Do not touch the air inlet or aluminium fin of the air conditioner.**  
Otherwise, injury may be caused.
  - **Do not place objects in direct proximity of the outdoor unit and do not let leaves and other debris accumulate around the unit.**  
Leaves are a hotbed for small animals which can enter the unit. Once in the unit, such animals can cause malfunctions, smoke or fire when making contact with electrical parts.
-

## NOTE

- **Never press the button of the remote controller with a hard, pointed object.**  
The remote controller may be damaged.
- **Never pull or twist the electric wire of the remote controller.**  
It may cause the unit to malfunction.
- **Do not place appliances which produce open fire in places exposed to the air flow from the unit or under the indoor unit. It may cause incomplete combustion or deformation of the unit due to the heat.**
- **Arrange the drain hose to ensure smooth drainage. Incomplete drainage may cause wetting of the building, furniture etc.**
- **Do not place the controller exposed to direct sunlight.**  
The LCD display may get discolored, failing to display the data.
- **Do not wipe the controller operation panel with benzine, thinner, chemical dustcloth, etc.**  
The panel may get discolored or the coating peeled off. If it is heavily dirty, soak a cloth in water-diluted neutral detergent, squeeze it well and wipe the panel clean. And wipe it with another dry cloth.
- **Dismantling of the unit, treatment of the refrigerant, oil and eventual other parts, should be done in accordance with the relevant local and national regulations.**
- **Do not dry the filter by exposing it to direct sunlight or warming it using fire, etc. Doing so can result in the deformation of the filter.**

## 3. OPERATION RANGE

If the temperature or the humidity is beyond the following conditions, safety devices may work and the air conditioner may not operate, or sometimes, water may drop from the indoor unit.

OUTDOOR UNIT	OPERATION	TEMPERATURE (°F)	
		OUTDOOR	INDOOR
RZQ24·30·36·42MVJU	COOLING	23 to 115 (DB)	57 to 77 (WB)
	HEATING	5 to 64.5 (WB)	59 to 80.5 (DB)

DB: Dry bulb temperature (°F)

WB: Wet bulb temperature (°F)

The setting temperature range of the remote controller is 60°F to 90°F.

## 4. INSTALLATION SITE

### Regarding places for installation

- **Is the air conditioner installed at a well-ventilated place where there are no obstacles around?**
- **Do not use the air conditioner in the following places.**
  - a. Filled with much mineral oil such as cutting oil
  - b. Where there is much salt such as a beach area
  - c. Where sulfured gas exists such as a hot-spring resort
  - d. Where there are considerable voltage fluctuations such as a factory or plant
  - e. Vehicles and vessels
  - f. Where there is much spray of oil and vapor such as a cookery, etc.
  - g. Where there are machines generating electromagnetic waves
  - h. Filled with acid and/or alkaline steam or vapor
- **Is a snow protection measure taken?**  
For details, consult your dealer.

### Regarding wiring

- **All wiring must be performed by an authorized electrician.**  
To do wiring, ask your dealer. Never do it by yourself.
- **Make sure that a separate power supply circuit is provided for this air conditioner and that all electrical work is carried out by qualified personnel according to local laws and regulations.**

### Pay attention to running noises, too

- **Are the following places selected?**
  - a. A place that can sufficiently withstand the weight of the air conditioner with less running noises and vibrations.
  - b. A place where the hot wind discharged from the air outlet of the outdoor unit and the running noises.
- **Are you sure that there are no obstacles near the air outlet of the outdoor unit?**  
Such obstacles may result in declined performance and increased running noises.
- **If abnormal noises occur in use, consult your dealer.**

### Regarding drainage of drain pipe







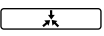
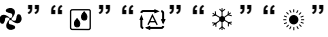

- **Is the drain pipe executed to perform complete drainage?**

If proper drainage is not carried out from the outdoor drain pipes during air-conditioning operation, chances are that dust and dirt are clogged in the pipe. This may result in a water leakage from the indoor unit. Under such circumstances, stop the operation of the air conditioner, and then consult your dealer or our service station.

## 5. NAME AND FUNCTION OF EACH SWITCH AND DISPLAY ON THE REMOTE CONTROLLER

Refer to figure 1 on page 3

The illustrations in this operating manual correspond to the remote control format BRC1C type.

1	<b>ON/OFF BUTTON</b> Press the button and the system will start. Press the button again and the system will stop.
2	<b>OPERATION LAMP (RED)</b> The lamp lights up during operation.
3	<b>DISPLAY “” (UNDER CENTRALIZED CONTROL)</b> When this display shows, the system is UNDER CENTRALIZED CONTROL.
4	<b>DISPLAY “” (OPERATION MODE)</b> This display shows the current OPERATION MODE.
5	<b>DISPLAY “ TEST” (INSPECTION/TEST OPERATION)</b> When the INSPECTION/TEST OPERATION BUTTON is pressed, the display shows the system mode is in.
6	<b>DISPLAY “” (PROGRAMMED TIME)</b> This display shows the PROGRAMMED TIME of the system start or stop.
7	<b>DISPLAY “” (SET TEMPERATURE)</b> This display shows the set temperature.
8	<b>DISPLAY “” (FAN SPEED)</b> This display shows the set fan speed.
9	<b>DISPLAY “” (AIR FLOW FLAP)</b> Refer to “AIR FLOW DIRECTION ADJUST”.
10	<b>DISPLAY “” (TIME TO CLEAN AIR FILTER)</b> Refer to “HOW TO CLEAN THE AIR FILTER”.
11	<b>DISPLAY “” (DEFROST)</b> Refer to “DEFROST OPERATION”.
12	<b>NON-FUNCTIONING DISPLAY</b> If that particular function is not available, pressing the button may display the words “NOT AVAILABLE” for a few seconds.
13	<b>TIMER MODE START/STOP BUTTON</b> Refer to “PROGRAM TIMER OPERATION”.

14	<b>TIMER ON/OFF BUTTON</b> Refer to “PROGRAM TIMER OPERATION”.
15	<b>INSPECTION/TEST OPERATION BUTTON</b> This button is used only by qualified service persons for maintenance purposes.
16	<b>PROGRAMMING TIME BUTTON</b> Use this button for programming “START and/or STOP” time.
17	<b>TEMPERATURE SETTING BUTTON</b> Use this button for SETTING TEMPERATURE.
18	<b>FILTER SIGN RESET BUTTON</b> Refer to “HOW TO CLEAN THE AIR FILTER”.
19	<b>FAN SPEED CONTROL BUTTON</b> Press this button to select the fan speed, HIGH or LOW, of your choice.
20	<b>OPERATION MODE SELECTOR BUTTON</b> Press this button to select OPERATION MODE.
21	<b>AIR FLOW DIRECTION ADJUST BUTTON</b> Refer to “AIR FLOW DIRECTION ADJUST”.
<b>NOTE</b> 	
<ul style="list-style-type: none"> <li>For the sake of explanation, all indications are shown on the display in figure 1 on page 3 contrary to actual running situations.</li> </ul>	

## 6. OPERATION PROCEDURE

Refer to figure 1 on page 3

- To protect the unit, turn on the main power switch 6 hours before operation.
- If the main power supply is turned off during operation, operation will restart automatically after the power turns back on again.



## COOLING, HEATING, AUTOMATIC, FAN, AND PROGRAM DRY OPERATION

Operate in the following order.

1



### OPERATION MODE SELECTOR

Press **OPERATION MODE SELECTOR** button several times and select the **OPERATION MODE** of your choice as follows.

- COOLING OPERATION ..... “ ❄️ ”
- HEATING OPERATION ..... “ ☀️ ”
- AUTOMATIC OPERATION ..... “ 🔄 ”
  - In this operation mode, COOL/HEAT changeover is automatically conducted.
- FAN OPERATION ..... “ 🌀 ”
- DRY OPERATION ..... “ 🏠 ”
  - The function of this program is to decrease the humidity in your room with the minimum temperature decrease.
  - Micro computer automatically determines TEMPERATURE and FAN SPEED.
  - This system does not go into operation if the room temperature is below 60°F.

Refer to figure 3 on page 3

2



### ON/OFF

Press **ON/OFF** button

OPERATION lamp lights up or goes off and the system starts or stops OPERATION.

### [EXPLANATION OF HEATING OPERATION]

#### DEFROST OPERATION

- As the frost on the coil of an outdoor unit increase, heating effect decreases and the system goes into DEFROST OPERATION.
- The indoor unit fan stops and the remote controller display shows “ 🏠 ”.
- After 6 to 8 minutes (maximum 10 minutes) of DEFROST OPERATION, the system returns to HEATING OPERATION.

### Regarding outside air temperature and heating capacity

- The heating capacity of the air conditioner declines as the outside air temperature falls. In this case, use the air conditioner in combination with other heating systems.
- A warm air circulating system is employed, and therefore it takes some time until the entire room is warmed up after the start of operation.
- An indoor fan runs to discharge a gentle wind automatically until the temperature inside the air conditioner reaches a certain level. At this time, the remote controller displays “ 🏠 ”. Leave it as it stands and wait for a while.
- When the warm air stays under the ceiling and your feet are cold, we recommend that you use a circulator (a fan to circulate the air inside the room). For details, consult your dealer.

### ADJUSTMENT

For programming TEMPERATURE, FAN SPEED and AIR FLOW DIRECTION, follow the procedure shown below.



### TEMPERATURE SETTING

Press **TEMPERATURE SETTING** button and program the setting temperature.

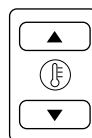

Each time this button is pressed, setting temperature rises 1°F.

Each time this button is pressed, setting temperature lowers 1°F.

- The setting is impossible for fan operation.

#### NOTE

- The setting temperature range of the remote controller is 60°F to 90°F.



### FAN SPEED CONTROL

Press **FAN SPEED CONTROL** button.

High or Low fan speed can be selected.

The microchip may sometimes control the fan speed in order to protect the unit.



## AIR FLOW DIRECTION ADJUST

Press the AIR FLOW DIRECTION button to adjust the air flow angle.

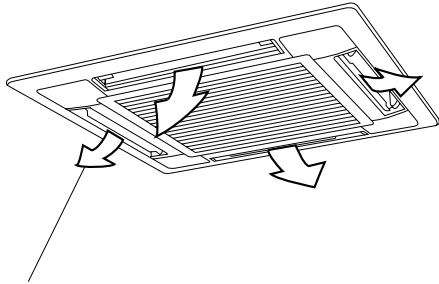

Up and down adjustment

- The movable limit of the flap is changeable. Contact your dealer for details.

Press the AIR FLOW DIRECTION ADJUST button to select the air direction as shown below.

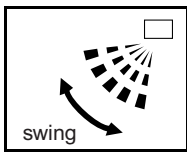

The AIR FLOW FLAP display swings as shown below and the air flow direction continuously varies. (Automatic swing setting)



Press AIR FLOW DIRECTION ADJUST button to select the air direction of your choice.

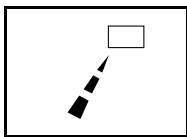

The AIR FLOW FLAP display stops swinging and the air flow direction is fixed (Fixed air flow direction setting).

## MOVEMENT OF THE AIR FLOW FLAP

For the following conditions, micro computer controls the air flow direction so it may be different from the display.

Operation mode	Cooling	Heating
Operation condition	<ul style="list-style-type: none"> <li>• When room temperature is lower than the set temperature</li> <li>• When operating continuously at horizontal air flow direction</li> </ul>	<ul style="list-style-type: none"> <li>• When room temperature is higher than the set temperature</li> <li>• At defrost operation</li> </ul>

Operation mode includes automatic operation.

## PROGRAM TIMER OPERATION

Operate in the following order.

- The timer is operated in the following two ways.
- Programming the stop time (⊕ · ○) .... The system stops operating after the set time has elapsed.
- Programming the start time (⊕ · |) .... The system starts operating after the set time has elapsed.
- The timer can be programmed a maximum of 72 hours.
- The start and the stop time can be simultaneously programmed.

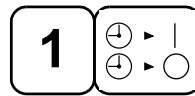

### TIMER MODE START/STOP

Press the TIMER MODE START/STOP button several times and select the mode on the display.

The display flashes.

For setting the timer stop .... "⊕ · ○"

For setting the timer start .... "⊕ · |"



### PROGRAMMING TIME

Press the PROGRAMMING TIME button and set the time for stopping or starting the system.

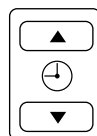

When this button is pressed, the time advances by 1 hour.

When this button is pressed, the time goes backward by 1 hour.

# 3

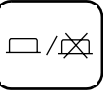

## TIMER ON/OFF

### Press the **TIMER ON/OFF** button.

The timer setting procedure ends.

The display “ ⊕ · ○ or ⊕ · | ” changes from flashing light to a constant light.

Refer to figure 4 on page 3

### NOTE

- When setting the timer Off and On at the same time, repeat the above procedure from 1 to 3 once again.

When the timer is programmed to stop the system after 3 hours and start the system after 4 hours, the system will stop after 3 hours and then 1 hour later the system will start.

- After the timer is programmed, the display shows the remaining time.
- Press the **TIMER ON/OFF** button once again to cancel programming. The display vanishes.

## 7. OPTIMUM OPERATION

Observe the following precautions to ensure the system operates.

- Adjust the room temperature properly for a comfortable environment. Avoid excessive heating or cooling.
- Prevent direct sunlight from entering a room during cooling operation by using curtains or blinds.
- Ventilate the room regularly.  
Using the unit for long periods of time requires attentive ventilation of the room.
- Keep doors and windows closed. If the doors and windows remain open, room air will flow out and cause to decrease the effect of cooling and heating.
- Do not place other heaters directly below the indoor unit.  
They may deform due to the heat.
- Never place objects near the air inlet and the air outlet of the unit. It may cause deterioration in the effect or stop in the operation.

- Turn off the main power supply switch when it is not used for long periods of time. When the main power switch is turned on, some watts of electricity is being used even if the system is not operating. Turn off the main power supply switch for saving energy. When reoperating, turn on the main power supply switch 6hours before operation for smooth running (Refer to MAINTENANCE).
- When the display shows “ ” (TIME TO CLEAN AIR FILTER), ask a qualified service person to clean the filter (Refer to MAINTENANCE).

## 8. MAINTENANCE (FOR SERVICE PERSONNEL)

### ONLY A QUALIFIED SERVICE PERSON IS ALLOWED TO PERFORM MAINTENANCE

#### IMPORTANT!

- **BEFORE OBTAINING ACCESS TO TERMINAL DEVICES, ALL POWER SUPPLY CIRCUITS MUST BE INTERRUPTED**
- To clean the air conditioner, be sure to stop operation, and turn the power switch off. Otherwise, an electric shock and injury may result.
- Do not wash the air conditioner with water. Doing so may result in an electric shock.
- Be careful with a scaffold or staging.  
Caution must be exercised because of work at a high place.

#### HOW TO CLEAN THE AIR FILTER

Clean the air filter when the display shows “ ” (TIME TO CLEAN AIR FILTER).

Increase the frequency of cleaning if the unit is installed in a room where the air is extremely contaminated.

If the dirt becomes impossible to clean, change the air filter.

(Contact your dealer when you exchange air filter.)

#### 1. Open the suction grille.

Slide the latches (×2) outward to the side and carefully lower the grille.

(Do the same procedure for closing.)

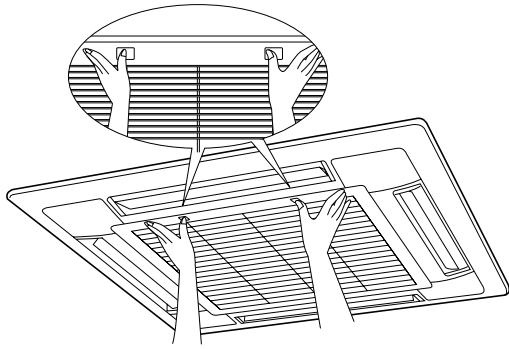

## 2. Remove the air filters.

Pull the air filter clips downward at an angle to detach the filter.

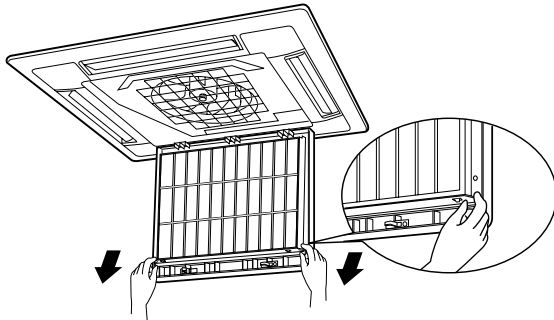

## 3. Clean the air filter.

Use vacuum cleaner **A**) or wash the air filter with water **B**).

**A**) Using a vacuum cleaner  
(Do not use air of 120°F or higher)



**B**) Washing with water  
When the air filter is very dirty, use soft brush and neutral detergent.

(Do not use water of 120°F or higher)



Remove water and dry in the shade.

### ⚠ NOTE

- Do not wash the air conditioner with hot water of more than 120°F, as doing so may result in discoloration and/or deformation.
- Do not expose it to fire, as doing so may result in burning.

## 4. Fix the air filter.

- (1) Hook the air filter on the projections at the top of the suction grille.
- (2) Press the bottom of the air filter against the projections on the bottom of the grille to snap the air filter into place.

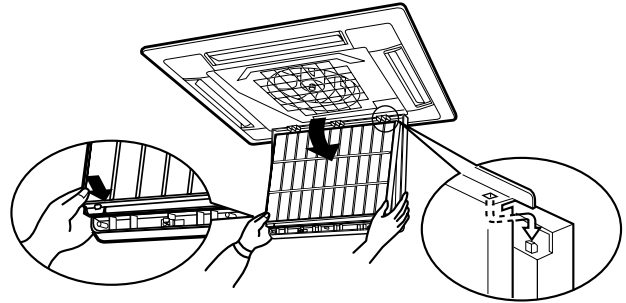

## 5. Shut the suction grille.

Refer to item No. 1.

## 6. Press the FILTER SIGN RESET BUTTON on the remote controller.

The display “” (TIME TO CLEAN AIR FILTER) vanishes.

### ⚠ NOTE

- Do not remove the air filter except when cleaning. Unnecessary handling may damage the filter.

## HOW TO CLEAN AIR OUTLET AND OUTSIDE PANELS

- Clean with soft cloth
- When it is difficult to remove stains, use water or neutral detergent.
- When the flap is extremely contaminated, remove it as below and clean or exchange it.  
(Contact your dealer when you exchange flap.)

### ⚠ WARNING

- Do not let the indoor unit get wet as it may cause an electric shock or fire.

### ⚠ NOTE

- Do not use gasoline, benzene, thinner, polishing powder, liquid insecticide. It may cause discoloring or warping.
- Do not scrub firmly when washing the blade with water.  
The surface sealing may peel off.
- Do not use water or air of 120°F or higher for cleaning air filters and outside panels.

## HOW TO CLEAN THE SUCTION GRILLE

### 1. Open the suction grille.

Slide the latches (×2) and carefully lower the grille.

(Do the same procedure for closing.)

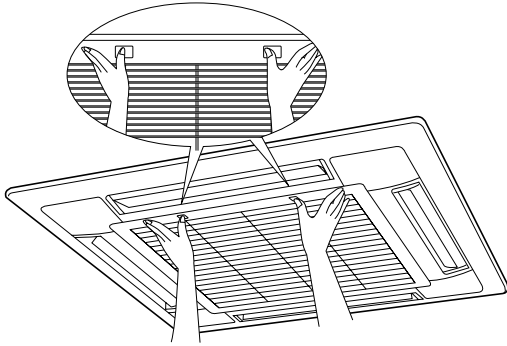

### 2. Remove the air filter.

Refer to HOW TO CLEAN THE AIR FILTER.

### 3. Detach the suction grille.

Open the suction grille 45 degrees and lift it upward.

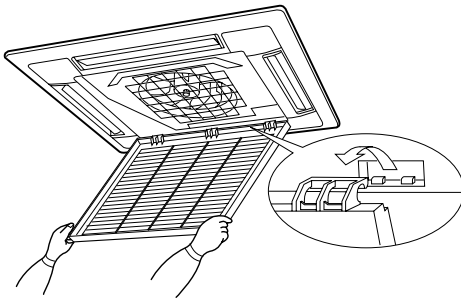

### 4. Clean the suction grille.

Wash with a soft bristle brush and neutral detergent or water, and dry thoroughly.



### NOTE

- When badly soiled, spray with a typical kitchen cleanser and let sit for about 10 minutes. Then, wash with water.

### 5. Reattach the suction grille.

Refer to item No. 3.

### 6. Fix the air filter.

Refer to HOW TO CLEAN THE AIR FILTER.

### 7. Close the suction grille.

Refer to item No. 1.

## START UP AFTER A LONG STOP

### Confirm the following

- Check that the air inlet and outlet are not blocked. Remove any obstacle.
- Check if the earth is connected. Might there be a broken wire somewhere? Contact your dealer if there are any problems.

### Clean the air filter and outside panels

- After cleaning the air filter, make sure to attach it.

### Turn on the main power supply switch

- The display on the remote controller will be shown when the power is turned on.
- To protect the unit, turn on the main power switch at least 6 hours before operation.

## WHAT TO DO WHEN STOPPING THE SYSTEM FOR A LONG PERIOD

### Turn on FAN OPERATION for a half day and dry the unit.

- Refer to “FAN OPERATION”.

### Cut off the power supply.

- When the main power switch is turned on, some watts of electricity is being used even if the system is not operating.

Turn off the main power supply switch for saving energy.

- The display on the remote controller will vanish when the main power switch is turned off.

### Clean the air filter and the exterior.

- Be sure to replace the air filter to its original place after cleaning. Refer to “MAINTENANCE”.

## 9. NOT MALFUNCTION OF THE AIR CONDITIONER

The following symptoms do not indicate air conditioner malfunction.

### I. THE SYSTEM DOES NOT OPERATE

- **The system does not restart immediately after the ON/OFF button is pressed.**

If the OPERATION lamp lights, the system is in normal condition.

It does not restart immediately because a safety device operates to prevent overload of the system. After 3 minutes, the system will turn on again automatically.

- **The system does not restart immediately when TEMPERATURE SETTING button is returned to the former position after pushing the button.**

If the OPERATION lamp lights, the system is in normal condition.

It does not restart immediately because a safety device operates to prevent overload of the system. After 3 minutes, the system will turn on again automatically.

- **The system does not start when the display shows “” (UNDER CENTRALIZED CONTROL) and it flashes for a few seconds after pressing an operation button.**  
This is because the system is under centralized control. Flashes on the display indicates that the system cannot be controlled by the remote controller.
- **The system does not start immediately after the power supply is turned on.**  
Wait at least 5 minute until the micro computer is prepared for operation.

## II. WHITE MIST COMES OUT OF A UNIT

- **When humidity is high during cooling operation. (In oily or dusty places)**  
If the inside of an indoor unit is extremely contaminated, the temperature distribution inside a room becomes uneven. It is necessary to clean the inside of the indoor unit. Ask your dealer for details on cleaning the unit. This operation requires a qualified service person.
- **When the system is changed over to HEATING OPERATION after DEFROST OPERATION.**  
Moisture generated by DEFROST becomes steam and exists.

## III. NOISE OF AIR CONDITIONERS

- **A ringing sound after the unit is started.**  
This sound is generated by the temperature regulator working.  
It will quiet down after about a minute.
- **A continuous flow “Shuh” sound is heard when the systems is in COOLING or DEFROST OPERATION.**  
This is the sound of refrigerant gas flowing through both indoor and outdoor units.
- **A “Shuh” sound which is heard at the start or immediately after the stop of operation or which is heard at the start or immediately after the stop of DEFROST OPERATION.**  
This is the noise of refrigerant caused by flow stop and flow change.
- **A continuous low “Shah” sound is heard when the system is in COOLING OPERATION or at a stop.**  
The noise is heard when the drain pump is in operation.
- **A “Pishi-pishi” squeaking sound is heard when the system is in operation or after the stop of operation.**  
Expansion and contraction of plastic parts caused by temperature change makes this noise.

## IV. DUST FROM THE UNITS

- **Dust may blow out from the unit after starting operation from long resting time.**  
Dust absorbed by the unit blows out.

## V. THE UNITS GIVE OFF ODORS

The unit absorbs the smell of rooms, furniture, cigarettes, etc., and then emits them.

## VI. THE LIQUID CRYSTAL OF THE REMOTE CONTROLLER SHOW “”

- **It happens immediately after the main power supply switch is turned on.**  
This shows that the remote controller is in normal condition.  
This continues temporary.

# 10. TROUBLE SHOOTING

- I. **If one of the following malfunctions occurs, take the measures shown below and contact your dealer.**

The system must be repaired by a qualified service person.

### WARNING

- **When the air conditioner is in abnormal conditions (smell of something burning, etc), unplug the power cord from the outlet, and contact your dealer**  
Continued operation under such circumstances may result in a failure, electric shock, and fire.

- If a safety device such as a fuse, a breaker or an earth leakage breaker frequently actuates;  
**Measure:** Do not turn on the main power switch.
- If the ON/OFF switch does not properly work;  
**Measure:** Turn off the main power switch.
- If water leaks from unit.  
**Measure:** Stop the operation.
- If the display “” (INSPECTION), “UNIT No.”, and the OPERATION lamp flash and the “MALFUNCTION CODE” appears.

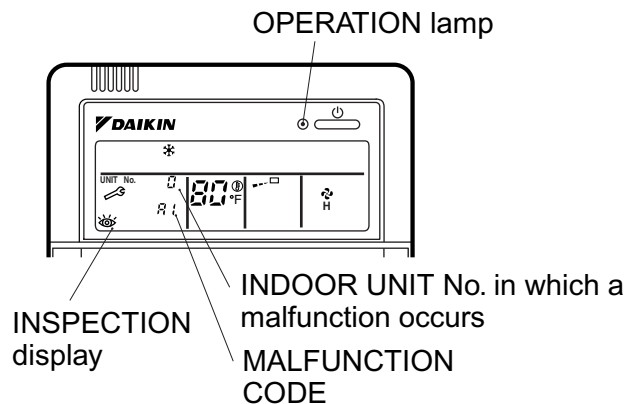

- **Measure:** Notify your dealer and inform him/her of the display.

**II. If the system does not properly operate except for the above mentioned case, and none of the above mentioned malfunctions is evident, investigate the system according to the following procedures.**

**1. If the system does not operate at all.**

- Check if there is a power failure.  
Wait until power is restored. If power failure occurs during operation, the system automatically restarts immediately after the power supply recovers.
- Check if a fuse has blown.  
Turn off the power supply.
- Is the breaker blown?  
Turn the power on with the breaker switch in the off position.  
Do not turn the power on with the breaker switch in the trip position.  
(Contact your dealer.)

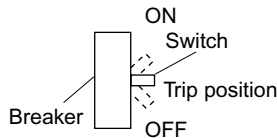

**2. If the system stops operating after operating the system.**

- Check if the air inlet or outlet of outdoor or indoor unit is blocked by obstacles.  
Remove the obstacle and make it well-ventilated.
- Check if the air filter is clogged.  
Ask a qualified service person to clean the air filters (Refer to MAINTENANCE).

**3. The system operates but it does not sufficiently cool or heat.**

- If the air inlet or outlet of the indoor or the outdoor unit is blocked with obstacles.  
Remove the obstacle and make it well-ventilated.
- If the air filter is clogged.  
Ask a qualified service person to clean the air filters (Refer to MAINTENANCE).
- If the set temperature is not proper (Refer to ADJUSTMENT).
- If the FAN SPEED button is set to LOW SPEED (Refer to ADJUSTMENT).
- If the air flow angle is not proper (Refer to AIR FLOW DIRECTION ADJUST).
- If the doors or the windows are open. Shut doors or windows to prevent wind from coming in.
- If direct sunlight enters the room (when cooling).  
Use curtains or blinds.

- When there are too many inhabitants in the room (when cooling).  
Cooling effect decreases if heat gain of the room is too large.
- If the heat source of the room is excessive (when cooling).  
Cooling effect decreases if heat gain of the room is too large.

**DAIKIN U.S. CORPORATION**

1645 Wallace Drive, Suite 110  
Carrollton, TX 75006

info@daikinac.com  
www.daikinac.com

**DAIKIN INDUSTRIES, LTD.**

Head office:

Umeda Center Bldg., 2-4-12, Nakazaki-Nishi,  
Kita-ku, Osaka, 530-8323 Japan

Tokyo office:

JR Shinagawa East Bldg., 2-18-1, Konan,  
Minato-ku, Tokyo, 108-0075 Japan

