

DX11TA SERIES CONDENSING UNIT

AIR CONDITIONING INSTALLATION & SERVICE REFERENCE

Important Safety Instructions

The following symbols and labels are used throughout this manual to indicate immediate or potential safety hazards. It is the owner's and installer's responsibility to read and comply with all safety information and instructions accompanying these symbols. Failure to heed safety information increases the risk of personal injury, property damage, and/or product damage.



WARNING

HIGH VOLTAGE!
Disconnect ALL power before servicing. Multiple power sources may be present. Failure to do so may cause property damage, personal injury or death.



WARNING

Only personnel that have been trained to install, adjust, service or repair (hereinafter, "service") the equipment specified in this manual should service the equipment. The manufacturer will not be responsible for any injury or property damage arising from improper service or service procedures. If you service this unit, you assume responsibility for any injury or property damage which may result. In addition, in jurisdictions that require one or more licenses to service the equipment specified in this manual, only licensed personnel should service the equipment. Improper installation, adjustment, servicing or repair of the equipment specified in this manual, or attempting to install, adjust, service or repair the equipment specified in this manual without proper training may result in product damage, property damage, personal injury or death.

Shipping Inspection

Always keep the unit upright; laying the unit on its side or top may cause equipment damage. Shipping damage, and subsequent investigation is the responsibility of the carrier. Verify the model number, specifications, electrical characteristics, and accessories are correct prior to installation. The distributor or manufacturer will not accept claims from dealers for transportation damage or installation of incorrectly shipped units.

Codes & Regulations

This product is designed and manufactured to comply with national codes. Installation in accordance with such codes and/or prevailing local codes/regulations is the responsibility of the installer. The manufacturer assumes no responsibility for equipment installed in violation of any codes or regulations. Rated performance is achieved after 20 hours of operation. Rated performance is delivered at the specified airflow. See outdoor unit specification sheet for split system models or product specification sheet for packaged and light commercial models. Specification sheets can be found at www.daikinac.com for Daikin brand products. Within the website, please select the residential or commercial products menu and then select the submenu for the type of product to be installed, such as air conditioners or heat pumps, to access a list of product pages that each contain links to that model's specification sheet.

The United States Environmental Protection Agency (EPA) has issued various regulations regarding the introduction and disposal of refrigerants. Failure to follow these regulations may harm the environment and can lead to the imposition of substantial fines. Should you have any questions please contact the local office of the EPA.

If replacing a condensing unit or air handler, the system must be manufacturer approved and Air Conditioning, Heating, and Refrigeration Institute (AHRI) matched. **NOTE:** Installation of unmatched systems is strongly discouraged.

Refer to the unit Specification Sheet for the recommended indoor model selection. **NOTE:** This unit must be used with a purchased two stage room thermostat with 24 VAC control circuitry.

Outdoor units are approved for operation above 55°F in cooling mode. Operation below 55°F requires the use of an approved low ambient kit.

Damage to the unit caused by operating the unit in a structure that is not complete (either as part of new construction or renovation) is not covered under the warranty.

Installation Clearances

This unit is designed for outdoor installations only. Special consideration must be given to location of the condensing unit(s) in regard to structures, obstructions, other units, and any/all other factors that may interfere with air circulation. Where possible, the top of the unit should be completely unobstructed; however, if vertical conditions require placement beneath an obstruction **there should be a minimum of 60 inches between the top of the unit and the obstruction(s)**. The specified dimensions meet requirements for air circulation only. Consult all appropriate regulatory codes prior to determining final clearances.



Another important consideration in selecting a location for the unit(s) is the angle to obstructions. Either side adjacent the valves can be placed toward the structure provided the side away from the structure maintains minimum service clearance. Corner installations are strongly discouraged.

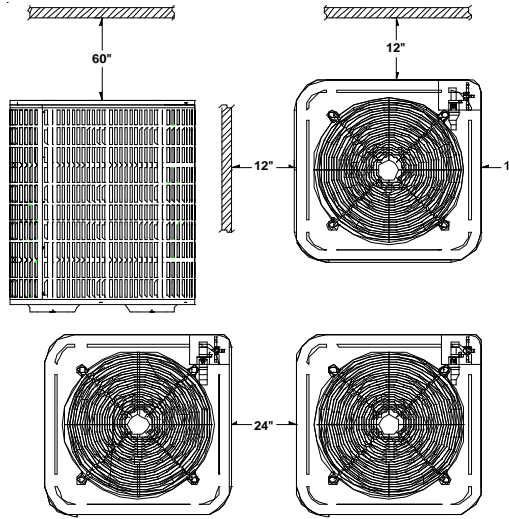

This unit can be located at ground floor level or on flat roofs. At ground floor level, the unit must be on a solid, level foundation that will not shift or settle. To reduce the possibility of sound transmission, the foundation slab should not be in contact with or be an integral part of the building foundation. The foundation slab should be a minimum of 6" wider than the unit in all directions. Ensure the foundation is sufficient to support the unit. A concrete slab raised above ground level provides a suitable base. The selected site should be no greater than 50' below or 70' above the evaporator section. For optimum performance, the minimum length interconnecting tubing is preferred. When possible minimize the amount of bends and turns.

Rooftop Installations

If it is necessary to install this unit on a roof structure, ensure the roof structure can support the weight and that proper consideration is given to the weather-tight integrity of the roof. Since the unit can vibrate during operation, sound vibration transmission should be considered when installing the unit. Vibration absorbing pads or springs can be installed between the condensing unit legs or frame and the roof mounting assembly to reduce noise vibration.

Rigging

⚠ WARNING

To avoid possible injury or death, all panels must be in position and secured before lifting this equipment.

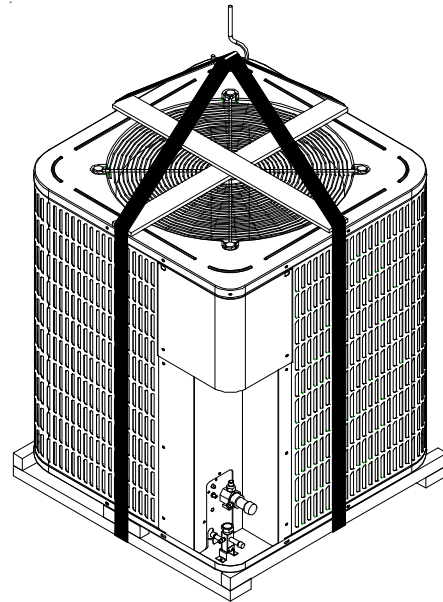

Use field-supplied spreader bars when lifting the unit to minimize the possibility of lifting cable/straps damage. To protect the cabinet louvers, use protective material such as plywood behind the cable/straps. Arrange the straps to form a central suspension point. **NOTE:** When raising and setting the unit, observe all safety rules. Remove shipping skid and all protection and lifting material after the unit is in place.

Safe Refrigerant Handling

While these items will not cover every conceivable situation, they should serve as a useful guide.

⚠ WARNING

Refrigerants are heavier than air. They can "push out" the oxygen in your lungs or in any enclosed space. To avoid possible difficulty in breathing or death:

- Never purge refrigerant into an enclosed room or space. By law, all refrigerants must be reclaimed.
- If an indoor leak is suspected, thoroughly ventilate the area before beginning work.
- Liquid refrigerant can be very cold. To avoid possible frostbite or blindness, avoid contact and wear gloves and goggles. If liquid refrigerant does contact your skin or eyes, seek medical help immediately.
- Always follow EPA regulations. Never burn refrigerant, as poisonous gas will be produced.

⚠ WARNING

To avoid possible explosion:

- Never apply flame or steam to a refrigerant cylinder. If you must heat a cylinder for faster charging, partially immerse it in warm water.
- Never fill a cylinder more than 80% full of liquid refrigerant.
- Never add anything other than R-410A to an R-410A cylinder. The service equipment used must be listed or certified for the type of refrigerant used.
- Store cylinders in a cool, dry place. Never use a cylinder as a platform or a roller.

⚠ WARNING

To avoid possible explosion, use only returnable (not disposable) service cylinders when removing refrigerant from a system.

- Ensure the cylinder is free of damage which could lead to a leak or explosion.
 - Ensure the hydrostatic test date does not exceed 5 years.
 - Ensure the pressure rating meets or exceeds 400 PSIG.
- When in doubt, do not use cylinder.

Refrigerant Lines

NOTE: For improved refrigerant management, equip the evaporator coil with a field-supplied thermal expansion valve (TXV) and the liquid line with a field-supplied liquid line solenoid. Ensure the solenoid is installed as close as possible to the evaporator coil to prevent refrigeration migration in the compressor "OFF" cycle.

Use only refrigerant grade (dehydrated and sealed) copper tubing to connect the condensing unit with the indoor evaporator. After cutting the tubing, install plugs to keep refrigerant tubing clean and dry prior to and during installation. Tubing should always be cut square keeping ends round and free from burrs. Clean the tubing to prevent contamination.

Do NOT let refrigerant lines come in direct contact with plumbing, ductwork, floor joists, wall studs, floors, and walls. When running refrigerant lines through a foundation or wall, openings should allow for sound and vibration absorbing material to be placed or installed between tubing and foundation. Any gap between foundation or wall and refrigerant lines should be filled with a pliable silicon-based caulk, RTV or a vibration damping material. Avoid suspending refrigerant tubing from joists and studs with rigid wire or straps that would come in contact with the tubing. Use an insulated or suspension type hanger. Keep both lines separate and always insulate the suction line.

Cond Unit (Tons)	REFRIGERANT LINE LENGTH (ft)					
	0-24		25-49*		50-74**	
	Line Diameter (In. OD)					
	Suct	Liq	Suct	Liq	Suct	Liq
7 1/2	1 1/8	5/8	1 3/8	5/8	1 3/8	5/8
10	1 3/8	5/8	1 5/8	5/8	1 5/8	5/8

* Full rating line size

** Lines greater than 74 feet in length or vertical elevation changes more than 50 feet refer to TP-108* Long Line Set Application Guideline or contact your distributor for assistance.

When Connecting With Two Cased Coils

1. Refer to the installation instructions provided in the cased coils and follow the instructions in Refrigerant Lines section for tubing connections.
2. Select the correct tubing diameters from the table on page 3 for suction line and liquid line connections.
3. Manifold the two tailpieces on the suction lines from two cased coils into a single connection. Similarly, manifold the two tailpieces on the liquid lines from two cased coils into a single connection.

4. Refer to the cased coils installation instructions to finish the tubing connections to cased coils.

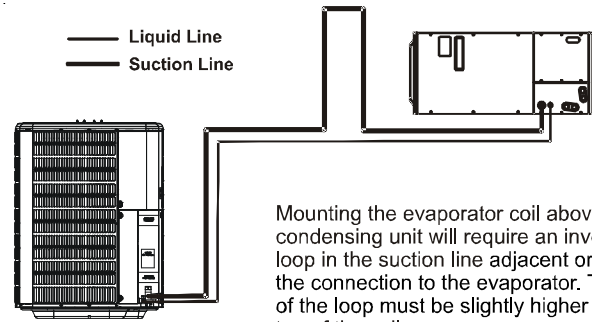

Mounting the evaporator coil above the condensing unit will require an inverted loop in the suction line adjacent or near the connection to the evaporator. The top of the loop must be slightly higher than the top of the coil.

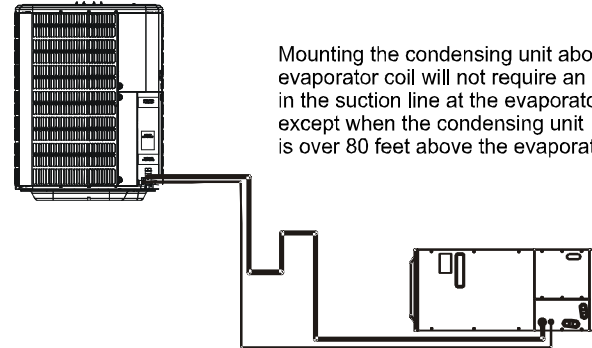

Mounting the condensing unit above the evaporator coil will not require an oil trap in the suction line at the evaporator, except when the condensing unit is over 80 feet above the evaporator.

Insulation is necessary to prevent condensation from forming and dropping from the suction line. Armflex (or satisfactory equivalent) with 3/8" min. wall thickness is recommended. In severe conditions (hot, high humidity areas) 1/2" insulation may be required. Insulation must be installed in a manner which protects tubing from damage and contamination.

Where possible, drain as much residual compressor oil from existing systems, lines, and traps; pay close attention to low areas where oil may collect. **NOTE:** If changing refrigerant types, ensure the indoor coil and metering device is compatible with the type of refrigerant being used; otherwise, the indoor coil must be replaced. To facilitate oil return to the compressor, a horizontal suction line should be pitched (1/2" per 10' toward the condensing unit.

Filter Drier and Sight Glass

A liquid line filter drier is factory installed. Field-install the supplied sight glass/moisture indicator on the liquid line as close as practical to the service valve.

Burying Refrigerant Lines

If burying refrigerant lines can not be avoided, use the following checklist.

1. Insulate liquid and suction lines separately.
2. Enclose all underground portions of the refrigerant lines in waterproof material (conduit or pipe) sealing the ends where tubing enters/exits the enclosure.
3. If the lines must pass under or through a concrete slab, ensure lines are adequately protected and sealed.

Refrigerant Line Connections

IMPORTANT: To avoid overheating the service valve, TXV valve, or filter drier while brazing, wrap the component with a wet rag, or use a thermal heat trap compound as recommended by the compound manufacturer. Use a brazing alloy of 2% minimum silver content. Do not use flux.

1. The ends of the refrigerant lines must be cut square, deburred, cleaned, and be round and free from nicks or dents. Any other condition increases the chance of a refrigerant leak.
2. This unit is factory shipped with a holding charge. "Sweep" the refrigerant line with nitrogen or inert gas during brazing to prevent the formation of copper-oxide inside the refrigerant lines.
3. After brazing, quench the joints with water or a wet cloth to prevent overheating of the service valve.
4. Ensure the filter drier paint finish is intact after brazing. If the paint of the steel filter drier has been burned or chipped, repaint or treat with a rust preventative. This is especially important on suction line filter driers which are continually wet when the unit is operating.

NOTE: Be careful not to kink or dent refrigerant lines. Kinked or dented lines will cause poor performance or compressor damage.

Do NOT make final refrigerant line connection until plugs are removed from refrigerant tubing.

NOTE: Before brazing, verify indoor piston size by checking the piston kit chart packaged with indoor unit.

Leak Testing (Nitrogen or Nitrogen-Traced)

WARNING

To avoid the risk of fire or explosion, never use oxygen, high pressure air or flammable gases for leak testing of a refrigeration system.

WARNING

To avoid possible explosion, the line from the nitrogen cylinder must include a pressure regulator and a pressure relief valve. The pressure relief valve must be set to open at no more than 150 psig.

Pressure test the system using dry nitrogen and soapy water to locate leaks. If you wish to use a leak detector, charge the system to 10 psi using the appropriate refrigerant then use nitrogen to finish charging the system to working pressure then apply the detector to suspect areas. If leaks are found, repair them. After repair, repeat the pressure test. If no leaks exist, proceed to system evacuation.

System Evacuation

Condensing unit liquid and suction valves are closed to contain the charge within the unit. The unit is shipped with the valve stems closed and caps installed. **Do not open valves until the system is evacuated.**

WARNING

REFRIGERANT UNDER PRESSURE!

Failure to follow proper procedures may cause property damage, personal injury or death.

1. Connect the vacuum pump with 250 micron capability to the service valves.
2. Evacuate the system to 250 microns or less using suction **and** liquid service valves. Using both valves is necessary as some compressors create a mechanical seal separating the sides of the system.
3. Close pump valve and hold vacuum for 10 minutes. Typically pressure will rise during this period.

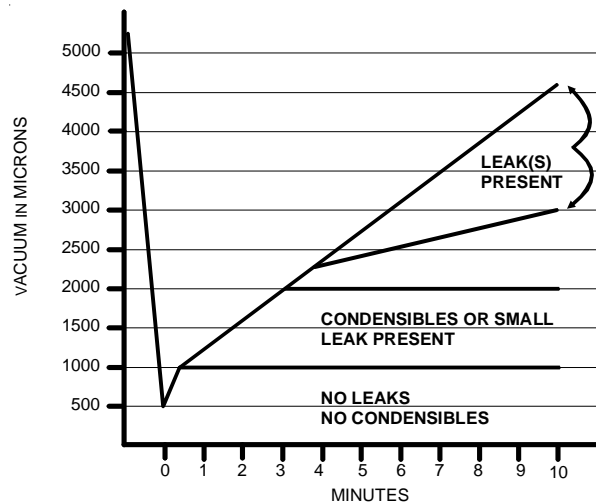

- If the pressure rises to 1000 microns or less and remains steady the system is considered leak-free; proceed to startup.
- If pressure rises above 1000 microns but holds steady below 2000 microns, moisture and/or noncondensibles may be present or the system may have a small leak. Return to step 2: If the same result is encountered check for leaks as previously indicated and repair as necessary then repeat evacuation.
- If pressure rises above 2000 microns, a leak is present. Check for leaks as previously indicated and repair as necessary then repeat evacuation.

Refer to the Remote Condensing Unit Service Manual for more detailed instructions on system evacuation, preliminary charge adjustment, and final charge adjustment.

Electrical Connections

WARNING

HIGH VOLTAGE!

Disconnect ALL power before servicing. Multiple power sources may be present. Failure to do so may cause property damage, personal injury or death due to electric shock. Wiring must conform with NEC or CEC and all local codes. Undersized wires could cause poor equipment performance, equipment damage or fire.





WARNING

To avoid the risk of fire or equipment damage, use copper conductors.

NOTICE

Units with reciprocating compressors and non-bleed TXV's require a Hard Start Kit.

This unit is designed for three phase operation. DO NOT OPERATE ON A SINGLE PHASE POWER SUPPLY. Measure the power supply to the unit. The supply voltage **must** be in agreement with the unit rating plate power requirements.

RATED VOLTAGE	MINIMUM SUPPLY VOLTAGE	MAXIMUM SUPPLY VOLTAGE
208/230V	197	253
460V	414	506

The condensing unit rating plate lists pertinent electrical data necessary for proper electrical service and overcurrent protection. Wires should be sized to limit voltage drop to 2% (max.) from the main breaker or fuse panel to the condensing unit. Consult the NEC, CEC, and all local codes to determine the correct wire gauge and length. The wire size must be sufficient to carry the Minimum Circuit Ampacity (MCA) listed on the serial plate.

The supply voltage can be unbalanced (phase to phase) within 2%. The following formula can be used to determine the percentage of voltage unbalance for your unit.

$$\begin{matrix} \text{Percentage} \\ \text{Voltage} \\ \text{Unbalance} \end{matrix} = \frac{\text{Max. Voltage Deviation From Average Voltage}}{\text{Average Voltage}}$$

Example:

$$L1-L2 = 220V$$

$$L2-L3 = 216V$$

$$\begin{aligned} \text{Average Voltage} &= (220 + 216 + 213)/3 \\ &= 649/3 \end{aligned}$$

$$\text{Maximum Deviation from Average} = 220 - 216 = 4$$

$$\begin{aligned} \% \text{ Voltage Unbalance} &= 100 \times (4/216) \\ &= 400/216 \end{aligned}$$

MAXIMUM ALLOWABLE LENGTH IN FEET TO LIMIT VOLTAGE DROP TO 2%

Wire Size (AWG)	Minimum Circuit Ampacity (MCA)							
	10	15	20	25	30	35	40	45
14	75	50	37	NR	NR	NR	NR	NR
12	118	79	59	47	NR	NR	NR	NR
10	188	125	95	75	63	54	NR	NR
8	301	201	150	120	100	86	75	68
6	471	314	235	188	157	134	118	110

*Based on NEC 1996

Example:

A 7 1/2 Ton unit is to be installed. The distance from the building to the unit is 75'. Calculate the minimum wire size assuming no more than 2% voltage drop.

MCA for 7 1/2 Ton 230V unit = 43.3 (from S&R plate).

Applying previous table wire sizes less than #8 AWG cannot be used for circuits which have a rating of 45A. The #8 wire is not suitable since the maximum length for a 45A circuit is 68'.

Solution: Use a #6 AWG wire suitable up to 110'.

NOTE: It is the contractor's responsibility to follow the NEC (USA) or CEC (Canada) when sizing the service wire for this unit.

*Always refer to the unit's S&R plate for actual ratings.

Local codes often require a disconnect switch located near the unit; do not install the switch on the unit. Refer to the installation instructions supplied with the indoor furnace/air handler for specific wiring connections and indoor unit configuration. Likewise, consult the instructions packaged with the thermostat for mounting and location information.

Overcurrent Protection

The following overcurrent protection devices are approved for use.

- Time delay fuses
- HACR type circuit breakers

These devices have sufficient time delay to permit the motor-compressor to start and accelerate its load.

Refer to the unit serial plate and this table for the maximum overcurrent protection permitted.

Run all line voltage wiring a conduit from the service disconnect box to the unit. Refer to the NEC (USA) or CEC (Canada) codes for the correct size conduit based on the wire size. The conduit enters the control box through the hole provided in the bottom.

NOTE: The control box hole is sized for 3/4" conduit. If permitted by code, a flexible conduit is preferred to minimize vibration transmission from the unit to the building.

Connect the line voltage wires to the L1, L2, and L3 terminals of the definite purpose contactor (located in the unit control box). Refer to the wiring diagram attached to the unit when making these connections.

Three Phase Compressor Rotation



CAUTION

Use care when handling scroll compressors. Dome temperatures could be hot.

Three phase scrolls are power phase dependent and can compress in more than one direction.

Verify proper rotation for three phase compressors by ensuring the suction pressure drops and discharge pressure rises when the compressor is energized. **NOTE:** When operated in reverse, a three phase scroll compressors is noisier and its current draw substantially reduced compared to marked values.

To correct, disconnect power and switch any two leads at the unit contactor and re-observe.

High Voltage Connections

Route power supply and ground wires through the high voltage port and terminate in accordance with the wiring diagram provided inside the control panel cover.

Low Voltage Connections

Condensing unit control wiring requires a two-conductor low voltage circuit from the room thermostat. The wiring should be no smaller than 18 AWG and the field connection for this circuit must be made in the unit control box using solderless connectors (i.e. wire nuts). See the following diagram for a typical low voltage hook-up.

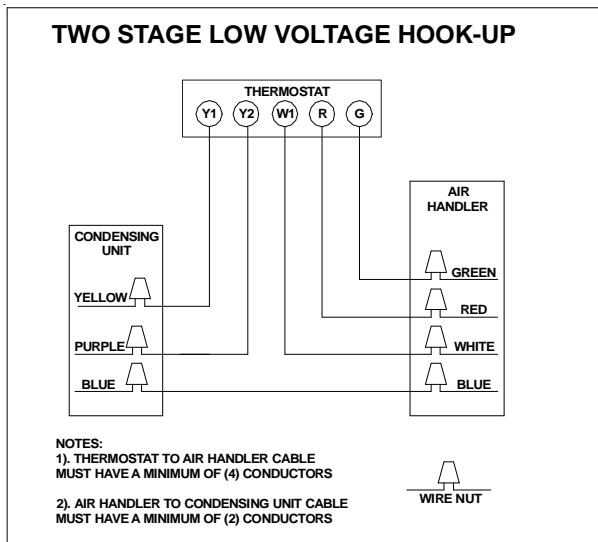

System Start Up

Never operate the compressor with the suction valve closed to test the compressor's pumping efficiency. In some cases, this can result in serious compressor damage and loss of warranty coverage.

For the 7-1/2 ton unit starting charge should be 18 lbs. of R-410A and 20 lbs. for the 10 ton unit. The length of line set, indoor unit airflow, condensing unit location and number of tubing fittings will have an impact on final unit charge amount. Turn the electrical power on, and let the system run. Wait for the refrigerant pressures to stabilize.

Charge Verification

WARNING

REFRIGERANT UNDER PRESSURE!

- Do not overcharge system with refrigerant.
 - Do not operate unit in a vacuum or at negative pressure.
- Failure to follow proper procedures may cause property damage, personal injury or death.

CAUTION

Use refrigerant certified to AHRI standards. Used refrigerant may cause compressor damage. Most portable machines cannot clean used refrigerant to meet AHRI standards.

NOTICE

Violation of EPA regulations may result in fines or other penalties.

CAUTION

Operating the compressor with the suction valve closed will void the warranty and cause serious compressor damage.

Final Charge Adjustment

The outdoor temperature must be 60°F or higher. Set the room thermostat to COOL, fan switch to AUTO, and set the temperature control well below room temperature.

After system has stabilized per startup instructions, check subcooling and superheat as detailed in the following section.

Expansion Valve System

NOTE: EXPANSION VALVE BULB MUST BE IN PLACE ON SUCTION LINE & INSULATED.

Expansion Valve Indoors

At stabilized cooling conditions and with an outdoor temperature of 60°F or higher, the system should have from 9°F to 13°F subcooling. For a proper subcooling reading, measure the refrigerant pressure and temperature at the outdoor unit's liquid line service valve. If you have less than 9°F subcooling, slowly adjust the charge by adding refrigerant. If you have more than 13°F subcooling, slowly adjust the charge by removing refrigerant. While reaching the proper subcooling level, it is important to know the discharge line temperature. This temperature should be at least 80°F over ambient or refrigerant could flood back to compressor.

Troubleshooting

Qualified Installer/Service Only

When troubleshooting, the first step should always be to check for clean coils, clean filter(s), and proper airflow. Indoor airflow should be 375 to 425 CFM per ton of cooling based on the size of the outdoor unit. The most common way of establishing indoor airflow is heating temperature rise. Indoor airflow will then be (Heating output of equipment) / (1.1 x temp. rise). In other cases, measurement of external static pressure is helpful. For details, see the Installation Instructions for your indoor unit.

TROUBLESHOOTING ANALYSIS TABLE

COMPLAINT	PROBABLE CAUSE	REMEDY
1. High Head Pressure	<ol style="list-style-type: none"> 1. Excessive charge of refrigerant in system. 2. Inadequate supply of air across the condenser coil. 3. Non-condensate gases in the system. 	<ol style="list-style-type: none"> 1. Purge or pump-down excessive charge. 2. Make certain that coil is not fouled in any way, or that air is not re-circulating. 3. Purge these gases from the system. Recharge system, if necessary.
2. Low Head Pressure	<ol style="list-style-type: none"> 1. System low on refrigerant. 2. Compressor valves broken. 	<ol style="list-style-type: none"> 1. Charge system until sight glass is clear of bubbles. 2. Replace compressor.
3. Low Suction Pressure	<ol style="list-style-type: none"> 1. Liquid line valve closed. 2. Restricted liquid line. 3. The bulb of the thermal expansion valve has lost its charge. 4. System low on refrigerant. 5. Dirty filters. 6. Coil frosted up. 7. Flash gas in the liquid line. 8. Quantity of air through evaporator not adequate. 	<ol style="list-style-type: none"> 1. Open the liquid line valve. 2. Replace filter-dryer. 3. Detach the bulb from the suction line and hold in one hand. If no liquid refrigerant goes through the valve, replace the valve. 4. Test the unit for leaks. Add refrigerant until sight glass is free from bubbles, after repairing leak. 5. Clean or replace filter. 6. Defrost and clean coil. Clean or replace filters. 7. Excessive liquid line drop. Check liquid line size. 8. Increase the blower speed.
4. High Suction Pressure	<ol style="list-style-type: none"> 1. Expansion valve stuck open. 2. Expansion valve bulb not in contact with suction line. 3. Suction and/or discharge valve leaking or broken. 	<ol style="list-style-type: none"> 1. Correct valve action or replace the valve. 2. Fasten bulb securely to suction line. 3. Replace compressor.
5. Compressor will not start.	<ol style="list-style-type: none"> 1. Disconnect switch open. 2. Blow fuse or fuse at disconnect switch. 3. Thermostat set too high. 4. Selector switch in "Off" position. 5. Contactor and/or relay coils burned out. 6. Loose or open electrical connection in either the control or power circuit. 	<ol style="list-style-type: none"> 1. Close the disconnect switch. 2. Check the cause of failure and replace the fuse. 3. Adjust to lower temperature. 4. Turn selector switch knob to "Cool" position. 5. Replace contactor and/or relay. 6. Inspect and secure all electrical connections.

Wiring Diagram



WARNING

HIGH VOLTAGE!

DISCONNECT ALL POWER BEFORE SERVICING OR INSTALLING THIS UNIT. MULTIPLE POWER SOURCES MAY BE PRESENT. FAILURE TO DO SO MAY CAUSE PROPERTY DAMAGE, PERSONAL INJURY OR DEATH.

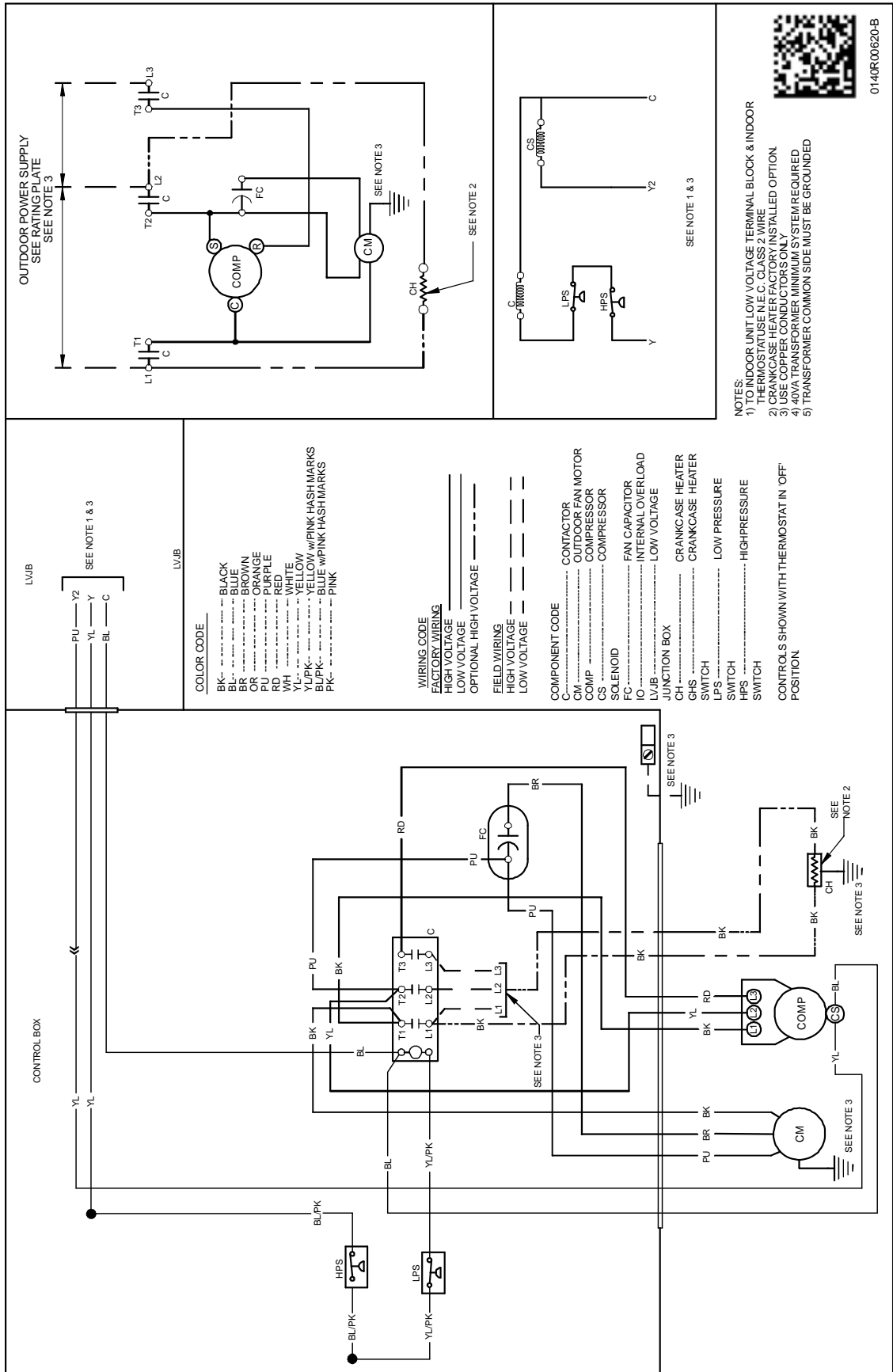

0140R00620-B

NOTES:
1) LOW VOLTAGE TERMINAL BLOCK & INDOOR THERMOSTAT USE N.E.C. CLASS 2 WIRE
2) CRANKCASE HEATER FACTORY INSTALLED OPTION
3) USE COPPER CONDUCTORS ONLY
4) 40VA TRANSFORMER MINIMUM SYSTEM REQUIRED
5) TRANSFORMER COMMON SIDE MUST BE GROUNDED

Wiring is subject to change, always refer to the wiring diagram on the unit for the most up-to-date wiring.