

Job Name:	
Tag#	

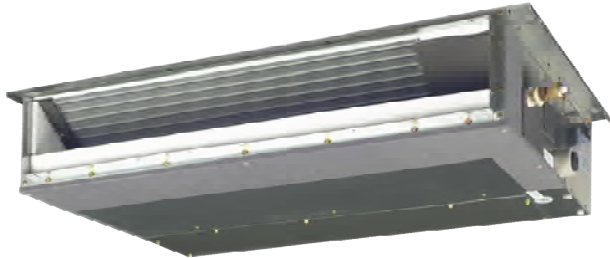

<b>Submittal Data Sheet</b>	<b>CDXS07LVJU</b>
.5-Ton Ducted Concealed Indoor Unit	



Complete warranty details available from your local dealer or at [www.daikincomfort.com](http://www.daikincomfort.com). To receive the 12-Year Parts Limited Warranty, online registration must be completed within 60 days of installation. Online registration is not required in California or Quebec. *If product is installed in a commercial application, limited warranty period is 5 years.*

Indoor Specifications				
	Cooling		Heating	
	H	M	H	M
Airflow Rate (cfm)	305	280	305	280
	L	SL	L	SL
	260	235	260	235
Sound (dBA) H / M / L	35 / 33 / 31		35 / 33 / 31	
Dimensions (H x W x D) (in)	7-7/8 x 27-9/16 x 24-7/16			
Weight (Lbs)	47			
Nominal Capacity (Btu/hr)	7,000			

\*See Outdoor Unit for Rated Capacities

Piping	
Liquid (in)	1/4
Gas (in)	3/8
Drain (in)	25/32

Electrical		
	Cooling	Heating
Running Current (Rated) (A)	.58/.52*	.58/.52*
Power Consumption (Rated) (W)	72/72*	72/72*

\*208/230V

# CDXS07LVJU Dimensional Data

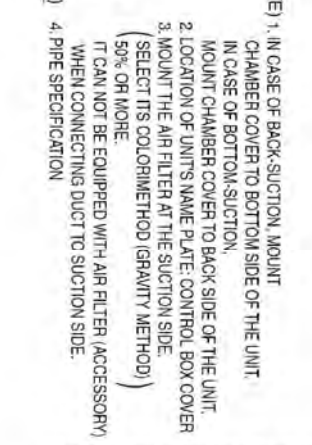
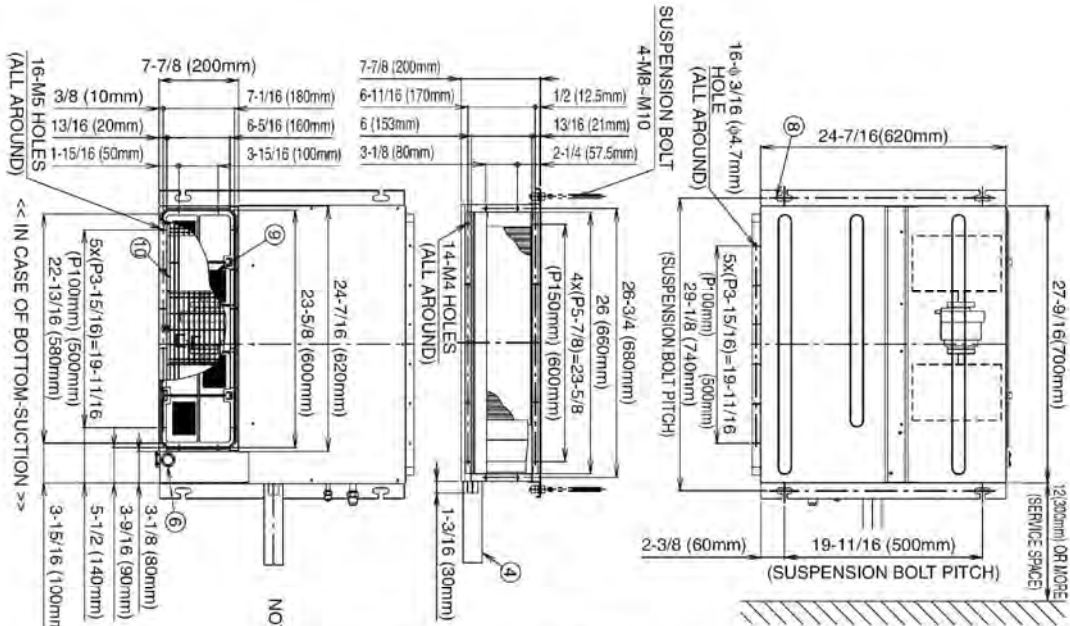

NOTE) 1. IN CASE OF BACK-SUCTION, MOUNT CHAMBER COVER TO BOTTOM SIDE OF THE UNIT.  
 2. LOCATION OF UNIT'S NAME PLATE: CONTROL BOX COVER (SELECT ITS COLOR/METHOD (GRANITY METHOD))  
 3. MOUNT THE AIR FILTER AT THE SUCTION SIDE.  
 4. IT CAN NOT BE EQUIPPED WITH AIR FILTER (ACCESSORY) WHEN CONNECTING DUCT TO SUCTION SIDE.  
 5. PIPE SPECIFICATION

NUMBER	NAME	DESCRIPTION
10	PROTECTION NET	
9	AIR FILTER (ACCESSORY)	
8	SUSPENSION BRACKET	
7	POWER SUPPLY CONNECTION	
6	INFLARED RECEIVER UNIT CONNECTION	
5	CONTROL BOX	
4	DRAIN HOSE (ACCESSORY)	I.D. φ31/32(φ25mm) (OUTLET)
3	SOCKET FOR DRAIN	VP20 (O.D. φ1-1/32 (φ26mm)/I.D. φ25/32 (φ20mm))
2	GAS PIPE CONNECTION	φ3/8 (φ9.5mm) (FLARE CONNECTION)
1	LIQUID PIPE CONNECTION	φ1/4 (φ6.4mm) (FLARE CONNECTION)

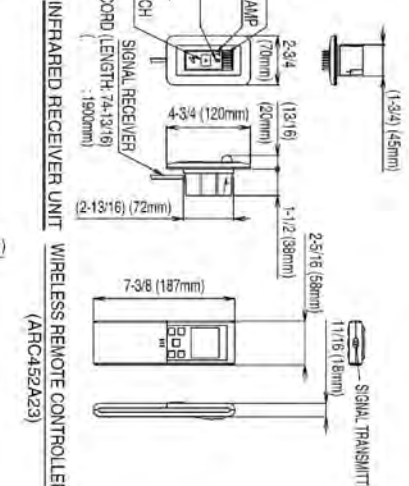
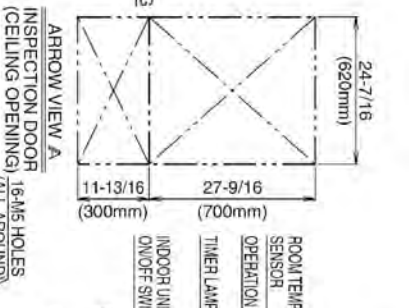
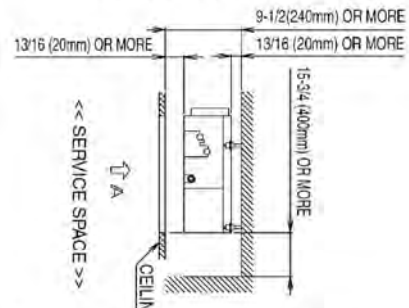
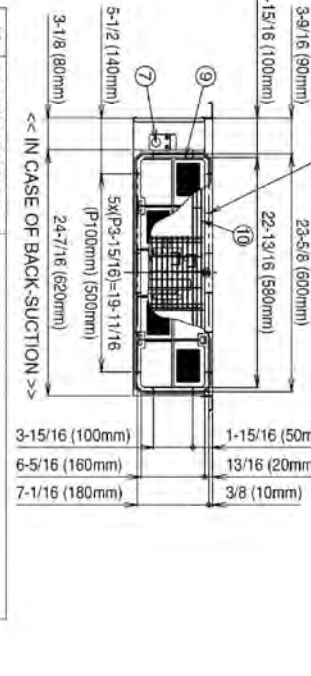
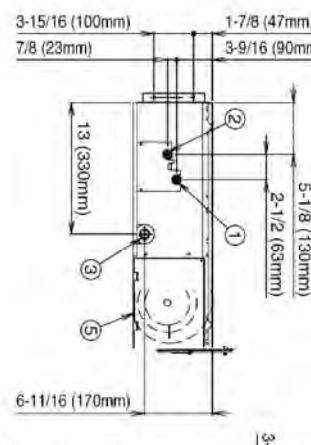

(Daikin's products are subject to continuous improvements. Daikin reserves the right to modify product design, specifications and information in this data sheet without notice and without incurring any obligations)

Included	Part Number	Description
	BRP072A43	Wireless Interface Adapter
	BRC944B2-A08	Wired Remote Controller kit
	BRCW901A08	Wired Remote Controller Cable – 25ft (included in above kit)
	BRCW901A03	Wired Remote Controller Cable – 10ft
	DACA-ARCW901P10	IR Receiver Cable, Plenum Rated, 10ft
	DACA-ARCW901P25	IR Receiver Cable, Plenum Rated, 25ft
	DACA-CP2-1	Maxi Orange Condensate Pump
	DACA-CP3-1	Mini Condensate Pump 5 gph
	KRP928BB2S	Interface Adaptor for DIII-NET

## External Static Pressure / Airflow Chart

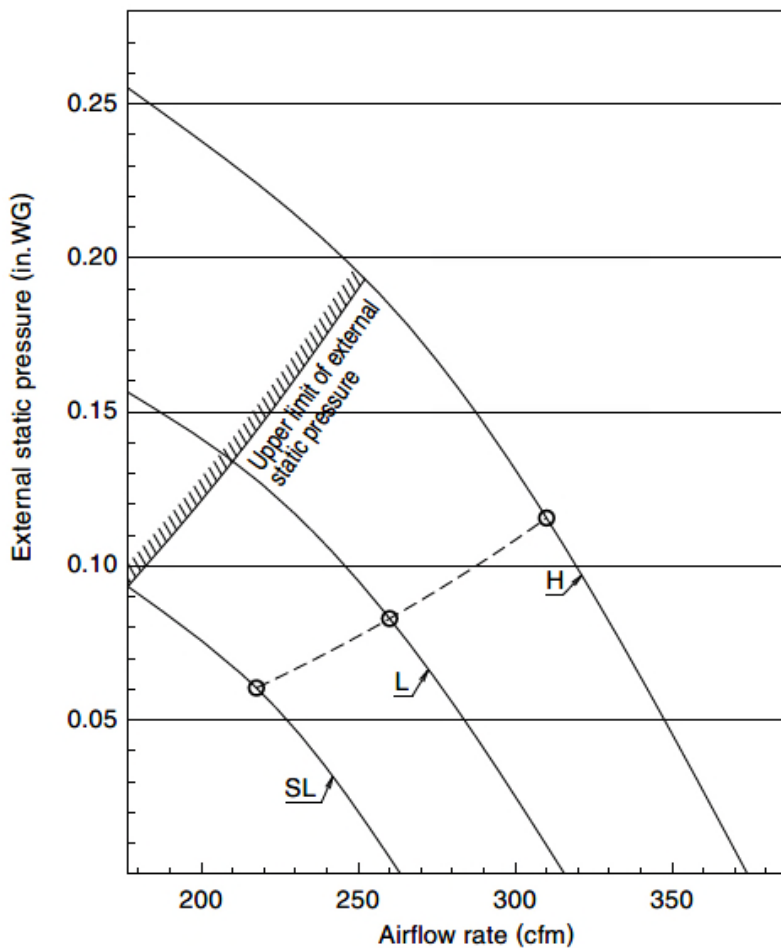

Daikin North America LLC 5151 San Felipe, Suite 500 Houston, TX 77056

(Daikin's products are subject to continuous improvements. Daikin reserves the right to modify product design, specifications and information in this data sheet without notice and without incurring any obligations)