



Daikin *One+* Smart Thermostat Reference Guide for Unitary Equipment





WARNING

Only personnel that have been trained to install, adjust, service or repair (hereinafter, “service”) the equipment specified in this manual should service the equipment. The manufacturer will not be responsible for any injury or property damage arising from improper service or service procedures. If you service this unit, you assume responsibility for any injury or property damage which may result. In addition, in jurisdictions that require one or more licenses to service the equipment specified in this manual, only licensed personnel should service the equipment. Improper installation, adjustment, servicing or repair of the equipment specified in this manual, or attempting to install, adjust, service or repair the equipment specified in this manual without proper training may result in product damage, property damage, personal injury or death.

PROP 65 WARNING FOR CALIFORNIA CONSUMERS



WARNING

Cancer and Reproductive Harm -
www.P65Warnings.ca.gov

0140M00517-A

TABLE OF CONTENTS

INTRODUCTION

Features and Benefits.....	6
How to Use the Quick Reference Cards	8
Equipment Compatibility	9

INSTALLING THE DAIKIN *ONE+* SMART THERMOSTAT

Mounting the Daikin <i>One+</i> Smart Thermostat	12
Wiring Thermostat to Communicating Systems.....	13
Wiring Diagrams	14
How to Wire a Humidifier to a Daikin Furnace	19
Wiring Troubleshooting.....	20
System Power-up Sequence	27

COMMISSIONING THE DAIKIN *ONE+* SMART THERMOSTAT

Welcome Screen.....	30
Begin Set-up / Step 1: Communication	32
Begin Set-up / Step 2: Personalization	33
Begin Set-up / Step 3: Equipment Set-up	34
How to Configure Humidifier on Modulating and 2-stage Furnaces	35
How to Configure Heat Kit.....	36
How to Set-up Lockout Temperature for Heat Pump	37
Aux Heater Heat Source Set-up	38
<i>Set-up Aux Heat Source</i>	39
<i>Heat Pump as Primary Heat Source</i>	40
<i>Aux Heat as the Primary Heat Source</i>	42
<i>Notes on Aux Heat</i>	43
Aux Humidifier and Dehumidifier Wiring.....	44
Aux Dehumidifier Set-up on the Daikin <i>One+</i>	45
Aux Humidifier Set-up on the Daikin <i>One+</i>	46
Aux Humidifier and Dehumidifier Operations	47
Begin Set-up / Step 4: System Optimization	48
How to Run System Test for Inverter Outdoor Units.....	49
How to Use Charge Mode	50
How to Calibrate Temperature.....	51
How to Check Error History	52
How to Check System Operational Information	53
Begin Set-up / Step 5: Preferences	54
How to Create Reminders	55

COMPLETE SET-UP

Dealer Navigation (How to return to Dealer Edit Mode).....	58
How to Set-up Humidification and Dehumidification Set-points.....	60

REFERENCES

FAQs	64
Support and Resources	66
Menu Outline Table of Contents.....	67
Important Notes.....	69
Quick Reference Card Details.....	70
Notes	71

Introduction



Features and Benefits

Designed with quality components

- 1 The high-resolution color touch screen display is protected by the same toughened glass used in smart phones.
- 2 The anodized aluminum bezel and dial are precision manufactured. The surfaces have a fine bead blast with a warm hued anodized finish. The dial rotation is extraordinarily smooth because it rests on a bearing assembly typically found in precision instruments. A switch behind the dial enables users to return to the home screen from any menu with a single tap.
- 3 An integrated Wi-Fi radio connects to the internet (via a home router) to the cloud and onto the homeowner mobile application. The Daikin cloud will also seamlessly integrate with open smart home architectures, including *Amazon Alexa* and *Google Assistant*, enabling consumers to effortlessly use features such as voice control. An Open API is also available for integration into smart home systems.
- 4 A thin LED light bar sits flush within the bottom surface and runs from edge to edge, delicately illuminating the wall beneath. Emitting a soft emotive glow, the light bar indicates the current system mode: red for heating, blue for cooling.
- 5 Built-in bubble level aids professional installation
- 6 Can be mounted standard surface mount or optional flush mount with Flush Mount Kit DKIT-FLSH-ONE.



- See page 69 for important notice concerning FCC



How to Use the Quick Reference Cards

There are quick reference cards packaged with the Daikin *One+* to help answer questions during the installation and commissioning.

Dealers



Install the thermostat

If you need to cover holes in the wall, place the trim plate against the wall first.

Then use the included screws to secure the terminal plate to the wall (sandwiching the trim plate if you're using it).

After connecting the wires, place the top of the thermostat against the terminal plate and press down until it snaps into place.

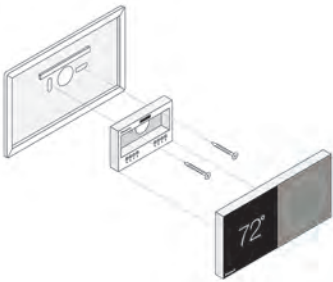
Get help at:
www.daikinone.com/smart_thermostats/oneplus/Pros





Trim plate (optional) Terminal plate Screws Thermostat

Homeowners

Install the app to control your smart thermostat from virtually anywhere.



Available on the App Store and Google Play.



www.daikinone.com/smart_thermostats/oneplus/app

Scanning the bar code on the **bottom left** corner will link you to a website related to the title of the card.

For further details on the Quick Reference Cards refer to page 70, or visit https://www.daikinone.com/smart_thermostats/oneplus

Equipment Compatibility

The Daikin *One+* offers two-way communication when combined with Daikin's smart inverter HVAC systems, serving as a cloud-connected hub and controller for communicating HVAC systems.

		Indoor Unit							
		Furnace		D24V Gateway Adaptor	Coil	Air Handler/Blower			
		DM97MC DC97MC	DM96VC DC96VC DM96SC-U DM80VC DC80VC DM80SC-U*		CAPEA CAPE CHPE	DFVE	DMVE	DMVT MBVCxx00	
Outdoor Unit	Air	DX9VC	✓	✓		–	–	✓	✓
		DX7TC	✓	✓		–	–	–	✓
		DX6VS	✓	✓	✓	✓	✓	–	√(MBVC)
	Heat Pump	DZ9VC	✓	✓		–	–	✓	✓
		DZ7TC	✓	✓		–	–	–	✓
		DZZ6VS	✓	✓		✓	✓	–	√(MBVC)
	24 VAC Condenser		✓	✓		–	–	–	–

The 24VAC Condenser (Legacy 24V) is compatible only with communicating modulating and 2-stage furnaces.

Installing the Daikin *One+* Smart Thermostat



< **DAIKIN**

setup

The Daikin smart thermostat saves each step as you proceed. You can always go back and change your settings.

begin setup

setup options

learn more

>

>

>

< **DAIKIN**

smart thermostat
setup

1 communication

2 personalization

3 equipment setup

4 system optimization

5 preferences

complete setup

Mounting the Daikin *One+* Smart Thermostat

- » Mounting the thermostat will be **leveled**:
 - Approximately **5' from the floor**.
 - On an **interior wall** using the included screws.
 - There are two options for mounting:

Standard Surface Mount



The Daikin *One+* smart thermostat comes with an attractive surface mount and trim bezel as standard.

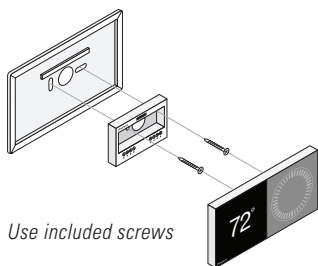

Use included screws

- » You do not need the trim plate to mount the thermostat.
- » Screws included are designed to mount in sheetrock or studs
- » Its recommended to use the screws provided with Daikin *One+* packaging for best results

Optional Flush Mount

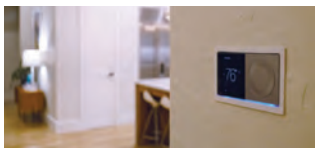

The Daikin *One+* smart thermostat also offers a flush mount installation option to provide homeowners with a modern built-in style option.

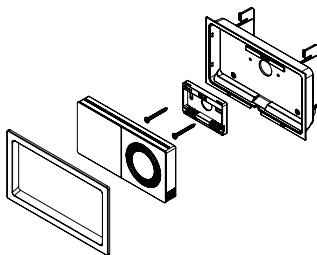

- » A template for marking a drywall cutout is included.
- » Use a stud and wire finder to verify the thermostat can be placed in desired location on the wall.
- » Allow a minimum 1 inch clearance between the desired location and stud for tightening and leveling purposes.

Wiring Thermostat to Communicating Systems



- » Maximum **wire** distance between the Daikin *One+* and the indoor unit **should not exceed 125 feet using 18-gauge wire.**
- » For installing the Daikin *Fit* outdoor system, **it is strongly recommended (for best results) to use 18-gauge wire.**
- » **Check for proper voltage before and after wiring is installed.**
 - 0.6 VDC between Data 1 and 2
 - 24 VAC between common and power
- » Wiring **communicating** indoor unit to **communicating** outdoor units.
 - Connect **1, 2, C** and **R** from the Daikin *One+*, to **1, 2, C** and **R** at the indoor unit.
 - Connect wires **1** and **2** from the indoor unit to **1** and **2** at the outdoor unit.
- » Wiring communicating indoor furnace unit to non-communicating outdoor units.
 - Connect **1, 2, C** and **R** from the Daikin *One+*, to **1, 2, C** and **R** at the indoor furnace unit.
 - Connect wire **Y1** from the indoor furnace unit to **Y1** at the outdoor unit
 - Under Equipment Setup add '**24 VAC Condenser**'.
 - Under '**24 VAC Condenser**' select the matching kBTU from '**cool CFM**' settings

Wiring Diagrams



- » Communicating indoor units supplied with a **9 pin** connector **only**, will move the connector to the far left to pair **R, C, G, W1** on the **9 pin** with **1, 2, R, C** on the indoor **PCB**.
- » Communicating outdoor units supplied with a **7 pin** connector **only**, will move the connector to the far **left** to pair **R, C** on the 7 pin with **1, 2** on the **outdoor PCB**.

Note: The Daikin One+ is labeled **1, 2, C, R**. **If wired incorrectly you will receive a communication error, or your equipment may not be recognized and displayed.**

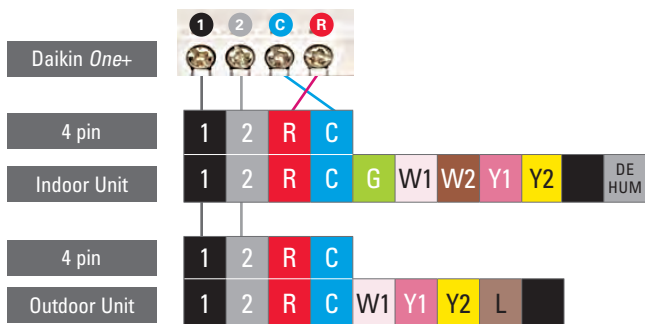

- » Communicating indoor units with a **4 pin connector supplied**, will match **1, 2, R, C** on the 4 pin with **1, 2, R, C** on the **indoor PCB**.
- » Communicating outdoor units with a **4 pin connector supplied**, will match **1, 2** on the 4 pin with **1, 2** on the **outdoor PCB**.

Note: The Daikin *One+* is labeled **1, 2, C, R**. **If wired incorrectly you will receive a communication error, or your equipment may not be recognized and displayed.**

Wiring Diagrams (cont'd)

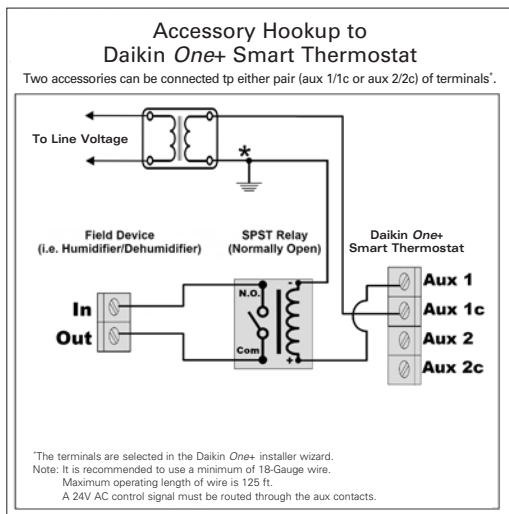
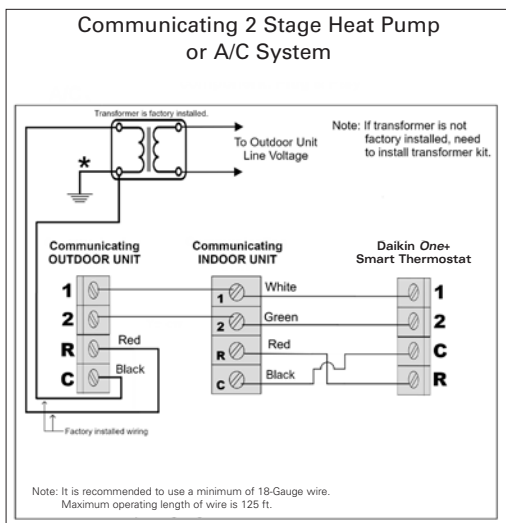

Communicating *Fit* System with AHU

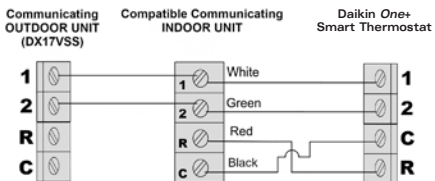

Note: It is **recommended** to use a minimum of 18-Gauge wire.
Maximum operating length of wire is 125 ft.

Communicating *Fit* System with Coil

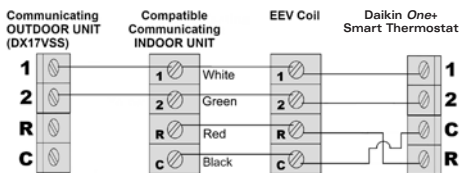

Notes: It is **recommended** to use a minimum of 18-Gauge wire.
Maximum operating length of wire is 125 ft.

Wiring Diagrams (cont'd)

Communicating Furnace with 24v Legacy Air Conditioner

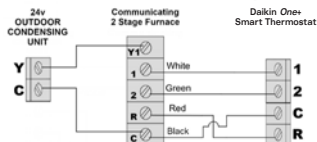

Note: It is recommended to use a minimum of 18-Gauge wire. Maximum operating length of wire is 125ft.

Communicating INVERTER Heat Pump or A/C System

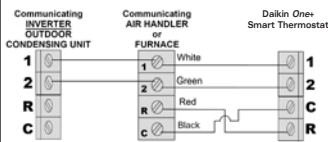

Note: It is recommended to use a minimum of 18-Gauge wire. Maximum operating length of wire is 125ft.

Interface Adapter-AOR DTA119A71 Installation Manual

IMPORTANT SAFETY INSTRUCTIONS

The following symbols and labels are used throughout this manual to indicate immediate or potential safety hazards. It is the owner's and installer's responsibility to read and comply with all safety information and instructions accompanying these symbols. Failure to heed safety information increases the risk of personal injury, property damage, and/or product damage.

WARNING

HIGH VOLTAGE!

DISCONNECT ALL POWER BEFORE SERVICING.
MULTIPLE POWER SOURCES MAY BE PRESENT.
FAILURE TO DO SO MAY CAUSE PROPERTY DAMAGE,
PERSONAL INJURY OR DEATH.



WARNING

ONLY PERSONNEL THAT HAVE BEEN TRAINED TO INSTALL, ADJUST, SERVICE OR REPAIR (HEREINAFTER, "SERVICE") THE EQUIPMENT SPECIFIED IN THIS MANUAL SHOULD SERVICE THE EQUIPMENT. THE MANUFACTURER WILL NOT BE RESPONSIBLE FOR ANY INJURY OR PROPERTY DAMAGE ARISING FROM IMPROPER SERVICE OR SERVICE PROCEDURES. IF YOU SERVICE THIS UNIT, YOU ASSUME RESPONSIBILITY FOR ANY INJURY OR PROPERTY DAMAGE WHICH MAY RESULT. IN ADDITION, IN JURISDICTIONS THAT REQUIRE ONE OR MORE LICENSES TO SERVICE THE EQUIPMENT SPECIFIED IN THIS MANUAL, ONLY LICENSED PERSONNEL SHOULD SERVICE THE EQUIPMENT.

IMPROPER INSTALLATION, ADJUSTMENT, SERVICING OR REPAIR OF THE EQUIPMENT SPECIFIED IN THIS MANUAL, OR ATTEMPTING TO INSTALL, ADJUST, SERVICE OR REPAIR THE EQUIPMENT SPECIFIED IN THIS MANUAL WITHOUT PROPER TRAINING MAY RESULT IN PRODUCT DAMAGE, PROPERTY DAMAGE, PERSONAL INJURY OR DEATH.

How to Wire a Humidifier to a Daikin Furnace

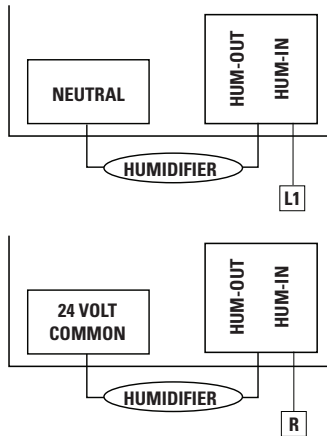

- » The indoor furnace control is equipped with a dedicated humidification relay which is available through ¼ inch terminals **HUM-IN** and **HUM-OUT**
- » **HUM-IN** must be powered with the desired voltage (24 VAC from the **R** terminal or 115 VAC from **L1** terminal)
- » Humidification relay turns ON when there is call for heat and a call for humidification
- » For 2-stage furnaces only, the humidifier relay supports the modes below:
 - **On with heat and hum:** Humidifier is turned on with heat demand and humidification demand
 - **On with hum (independent):** Humidifier is turned on with humidification demand
 - **OFF:** Humidifier remains off (relay never closes).

Wiring Troubleshooting

The following steps require no power to be applied.

- Check for any loose, disconnected, broken, or shorted wires between all connected components **BEFORE** applying power
- No short between Data 1 or Data 2 wires and R (24 VAC) or C (24 VAC common)
- Check for Data 1 and Data 2 wires reversed at the indoor unit, thermostat, or outdoor unit

After fixing all the wiring issues apply power

- Check for 24 VAC across R (24 VAC) and C (24 VAC common) terminals
- If there are still problems discovering the indoor or outdoor equipment then check for bias reading of 0.6 VDC. Bias reading of 0.6 VDC indicates a robust network that can handle high data volume without lock-up.

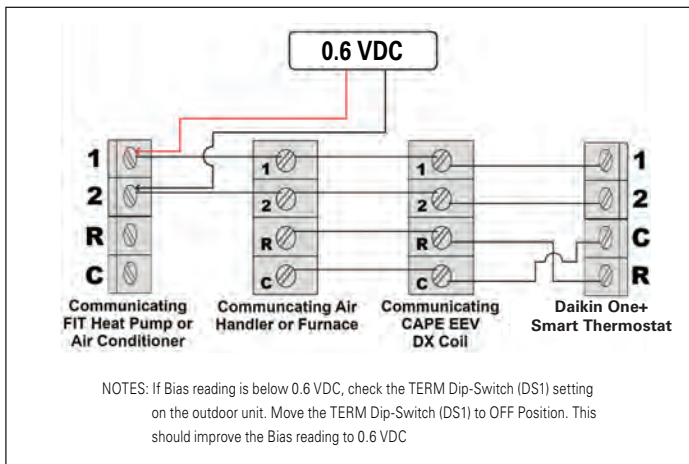

- **Follow the steps below to measure and achieve 0.6 VDC bias value.**
 - Turn OFF the thermostat and make sure the system is idle
 - Take Bias readings on the outdoor Heat Pump or Air Conditioner
 - Measure DC voltage between 24 VAC common to **Data 1 = D1 VDC**
 - Measure DC voltage between 24 VAC common and **Data 2 = D2 VDC**
 - Bias reading = $D1 \text{ VDC} - D2 \text{ VDC}$ (Subtract D2 from D1 to calculate bias voltage)
= 0.61 VDC
 - Measure DC voltage between Data 1 and Data 2. This value should equal the value calculated in the previous step.
 - Take Bias readings on indoor Air Handler or Furnace by repeating above steps on its terminal blocks.
 - Take Bias readings on CAPE EEV coil if connected by repeating above steps on its terminal blocks.
 - The Bias readings should match on all the equipment's terminal blocks.
 - If Bias reading is below 0.6 VDC, check the TERM Dip-Switch (DS1) setting on the outdoor unit. Move the TERM Dip-Switch (DS1) to OFF position. This should improve the Bias reading to 0.6 VDC.
 - After stabilizing the network, power down the entire HVAC system. Wait for a few minutes and power back up. It will take approximately 3-5 minutes for the HVAC system and thermostat to discover the indoor and outdoor equipment.

For a view of the DS1 switch on the outdoor unit PC boards, see pages 20-24.

1. 17 SEER Daikin *Fit*
2. 18 SEER (all tonnage)
3. 20 SEER (2 and 3 Ton)
4. 20 SEER (4 Ton)
5. 20 SEER (5 Ton)

Wiring Troubleshooting (cont'd)

View of the DS1 Switch on the Outdoor Unit PC Boards

1. 17 SEER Daikin *Fit*



2. 18 SEER (all tonnage)



Wiring Troubleshooting (cont'd)

3. 20 SEER (2 and 3 Ton)



4. 20 SEER (4 Ton)

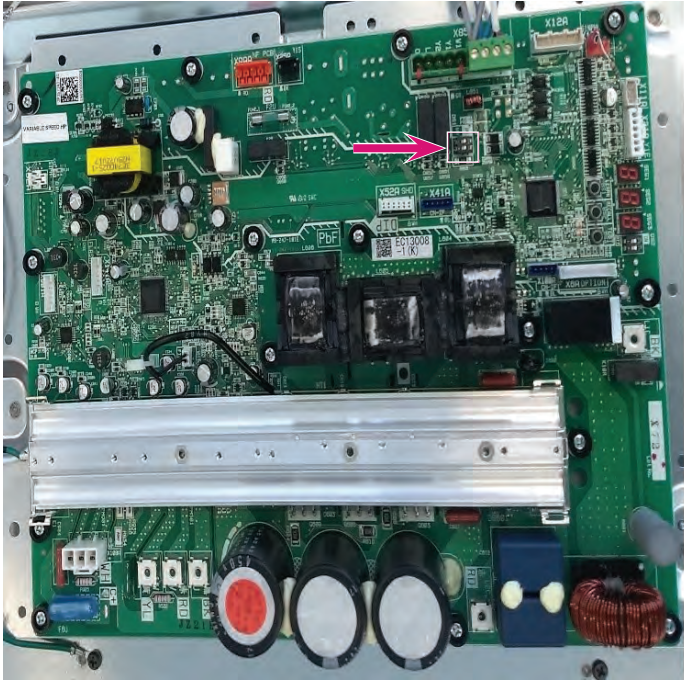

INSTALLING

Wiring Troubleshooting (cont'd)

5. 20 SEER (5 Ton)

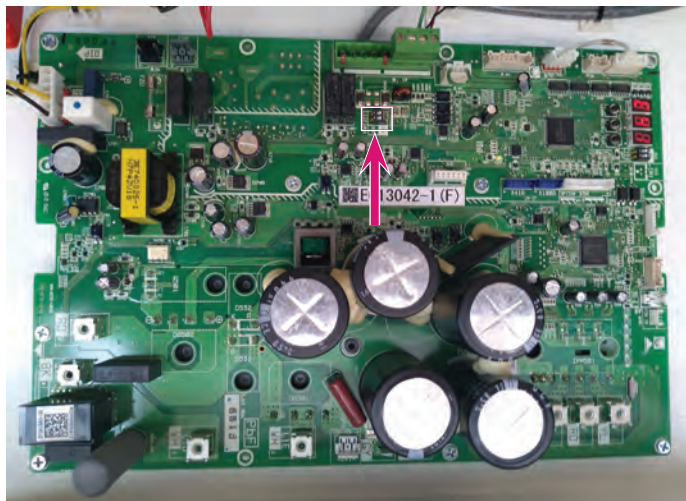

System Power-up Sequence

Follow the instructions to wire the Daikin *One+* smart thermostat with the communicating indoor and outdoor systems.

Mount the thermostat and power ON the indoor and outdoor units. The Daikin *One+* smart thermostat gets power from the indoor unit.

Follow the steps mentioned under Commissioning Daikin *One+* to configure the indoor unit and outdoor unit.

Commissioning
the Daikin *One+*
Smart Thermostat



Commissioning the Daikin One+ Smart Thermostat

- » The welcome screen displays basic instructions upon powering the thermostat. Select the right language and "use large font" if desired, then click continue.
- » Select the right equipment type. Unitary is the default, so just click continue if you have unitary equipment.
- » Under "setup options" is a link to do a factory reset of the thermostat.
- » The learn more screen displays the current thermostat firmware version and an option to check for a software update.

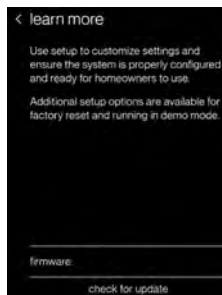
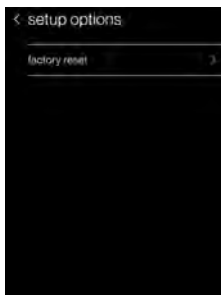
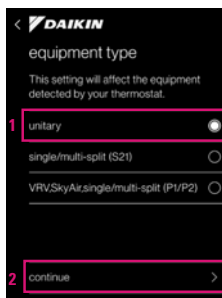
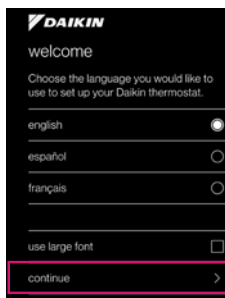

» Tapping **Begin set-up** starts the 5 step set-up process:

1. Communication.
2. Personalization.
3. Equipment Setup.
4. System Optimization.
5. Preferences.

» Begin set-up ensures the system is configured properly and ready for the homeowner to use.

Note: All of the **5 steps must be completed and reviewed** before you can **complete the set-up**.

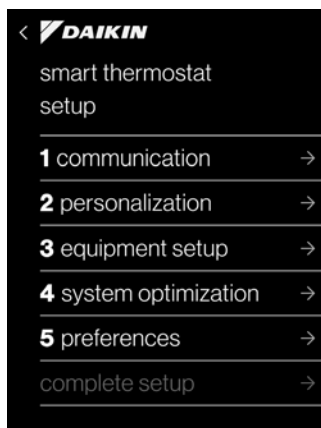
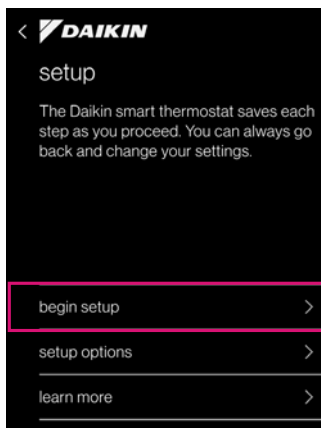

Begin Set-up / Communication

Step 1 – Communication

- » Configures **Communication Networks**.
- » Select home Wi-Fi to search for networks.
- » With **Wi-Fi configured**, the system can check the software version and update software to the **latest** version **automatically**.

Note: Tapping the Daikin logo returns to the setup screen.

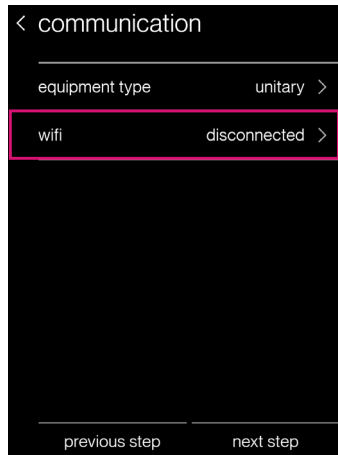

Begin Set-up / Personalization

Step 2 – Personalization

- » Tapping the **personalization tab** allows you to edit default information.
- » Personalization displays:
 - Language.
 - Use Large Font.
 - Date & Time.
 - If Wi-Fi is connected, date & time set automatically.
 - Thermostat Name.
 - Degree Units.



Step 3 – Equipment set-up

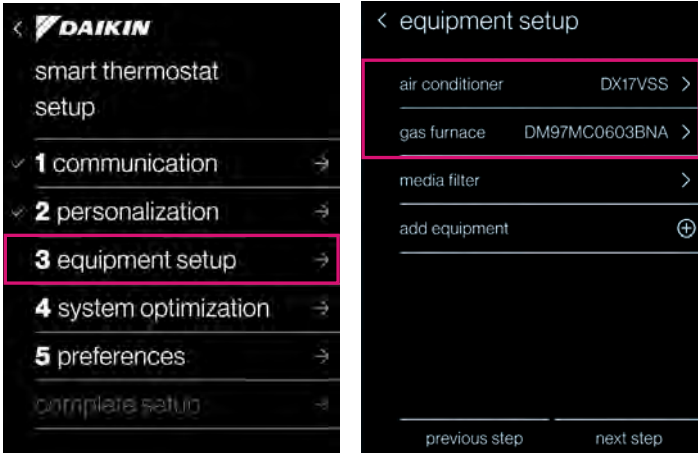

- » Displays equipment found by searching the communication network, or by adding/removing equipment and accessories from the preset list.
- » There are options to view and optimize settings that apply to the installed units.
 - View unit Specifications.
 - Configure
 - **Cool settings**
 - **Heat Settings**
 - **Heat Pump Settings**
 - **Humidifier Relay**
 - **Aux alarm**
 - **Heater Kit**

Reference to Menu Outline

- » For a detailed view of menu and sub-menu settings, refer to the Menu Outline Overview by visiting https://daikinone.com/smart_thermostats/oneplus/pros/DaikinOnePlus-CommissioningMenuOutline.pdf
- » Menus and sub-menus will display or not depending on the type of indoor and outdoor units detected.

How to Configure Humidifier on Modulating and 2-stage Furnaces

- » Refer to the **How to Wire a Humidifier to a Daikin Furnace** section under **Installing the Daikin One+ smart thermostat** section for details on wiring a humidifier directly to a furnace.
- » For 2-Stage furnaces, the Daikin One+ supports 'humidifier relay' settings with the following options:
 - ON: The humidifier is turned on when heat demand and humidification demand are present.
 - OFF: The humidifier remains off (the relay never closes).
- » For modulating furnaces, the humidifier is turned ON whenever heat demand and humidification demand are present.

Begin Set-up / Equipment Set-up (cont'd)

How to Configure Heat Kit

Heater kit configuration varies based on the type of the Indoor units.

DFVE/DMVE

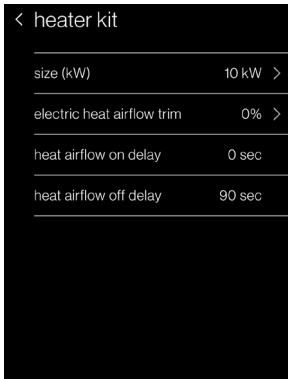

Some details have advanced settings.

- » Navigate to heater kit size sub-menu under the Air Handler

Insxtaller Wizard > equipment setup > air handler > heater kit > size (kW) > Select the heater kit size by scrolling available 'size(kW)' options.

- » If required, adjust 'electric heat airflow trim'

Installer Wizard > equipment setup > air handler > heater kit > electric heat airflow trim

- » Use dip switches on the board to configure the heater kit size. Please refer to the installation manual of these boards to locate the dip switches.

DMVT/MBVC

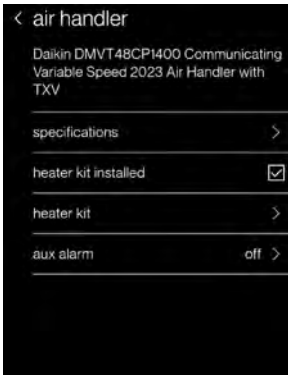

- » Heater kit size configured with dip switches will appear under

Installer Wizard > equipment setup > air handler > heater kit > size (kW)

Enable 'heater kit installed' checkbox.

Installer Wizard > equipment setup > air handler > heater kit installed

- » 'heater kit' sub-menu appears on enabling 'heater kit installed' checkbox
- » Inside 'heater kit' sub-menu 'heat airflow trim' value can be adjusted

How to Set-up Lockout Temperature for Heat Pump

Heat pump settings allow for adjustment of compressor lockout temperature and auxiliary (secondary) lockout temperature

ELECTRIC BACKUP HEAT

» Auxiliary heat lockout temperature:

- Auxiliary electric strip heat won't run above this outdoor temperature.
- Must be at least 10°F greater than heat pump lockout temperature.

Installer Wizard > equipment setup > heat pump > heat pump settings > aux heat lockout temp

» Heat pump lockout temperature:

- The heat pump compressor won't run below this outdoor temperature.
- Must be at least 10°F less than aux heat lockout temperature.

Installer Wizard > equipment setup > heat pump > heat pump settings > heat pump lockout temp

When the outdoor temp is between the heat pump lockout and aux lockout temperatures

- Backup heat is requested immediately if the difference between the heat set-point and indoor temperature is greater than 4°F
- Depending on load conditions and system performance, the thermostat will wait to request backup heat. Backup heat will only be requested when the temperature is not rising to meet the heat set-point in a reasonable amount of time.

DUAL-FUEL BALANCE POINT:

» Balance point lockout temperature:

- The heat pump will turn on above this temperature, and with v2.7 and higher software the gas furnace will turn on if the heat pump cannot maintain the heat setpoint.
- **Only the gas furnace will turn on below this lockout temperature.**

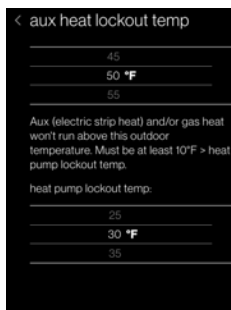

Begin Set-up / Equipment Set-up (cont'd)

Aux Heater Heat Source Set-up

- » Aux heat is supported in Unitary, VRV and SkyAir (P1P2), and single/multi-split (S21) systems. This document covers **Unitary systems**.
- » The thermostats aux outputs are dry contacts that close the connection to turn on the aux equipment.
- » A 24V AC control signal must be routed through one of the aux contacts of the thermostat.

Accessory Hookup to Daikin One+ Smart Thermostat

Two accessories can be connected to either pair (Aux 1/1c or Aux 2/2c) of terminals*.

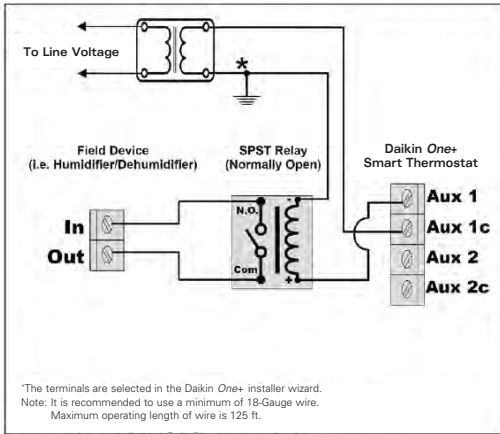

- » An aux heat source can be added to the Daikin One+ smart thermostat in the "Equipment Setup" menu using "add equipment".
- » For systems with heat pumps:
 - The aux heat can be set-up as primary or the secondary source of heat.
 - Emergency Heat mode will appear as a system mode and can be used to directly turn on the aux heat source.

- » For systems with AC-only outdoor units
 - The thermostat aux heat source is automatically the primary heat source.
 - Emergency heat mode will not appear
- » If the indoor unit is a gas furnace or an air handler with electric strip heat, all of these “aux heat” sources will be treated the same way except they may have different lockout temperatures.
 - The indoor unit aux heat lockout is in the heat pump menus
 - The thermostat aux heat lockout is in “aux heat source” menus.

Set-up aux heat source

- » Click on “add equipment” → “aux heat source”
- » Select “connection” and “aux 1” or “aux 2” as appropriate
- » **Default:** “heat pump is primary heat source” unless it is an AC outdoor unit.
- » Select control to adjust parameters

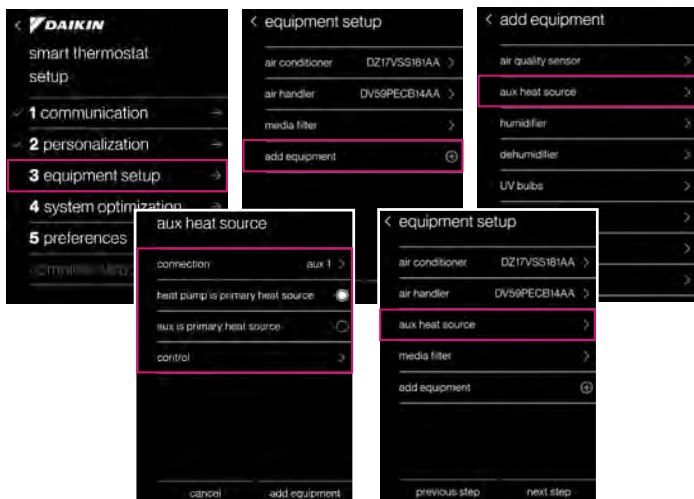

Begin Set-up / Equipment Set-up (cont'd)

Heat Pump as Primary Heat Source

With the heat pump as the primary heat source the heat pump will be used to maintain the heat set-point.

- » The demand-based control algorithm in the thermostat will determine when the aux heat source is needed to supplement the heat pump.
- » The heat pump lockout and the aux heat lockout are based on the ambient temperature data from the outdoor unit.

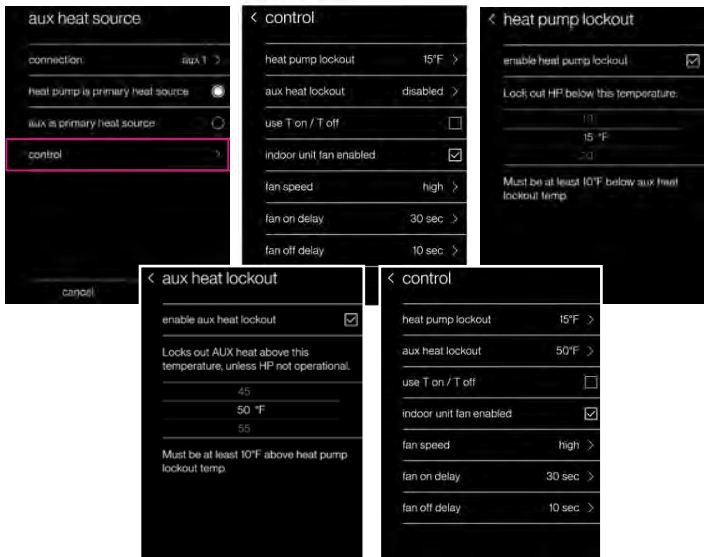

- » Heat pump lockout adjustable from -20°F to 65°F in 5°F increments. (required, default 15°F)
- » Aux heat lockout adjustable from -10°F to 75°F in 5°F increments. (optional, default 50°F)
- » Aux heat demand
 - Demand-based control (same as gas furnace or strip heat in indoor unit)

Heat Pump as Primary Heat Source (con't)

- » **T on and T off** provide an alternative control method to have the thermostat control the aux heat source using its PI control algorithm.

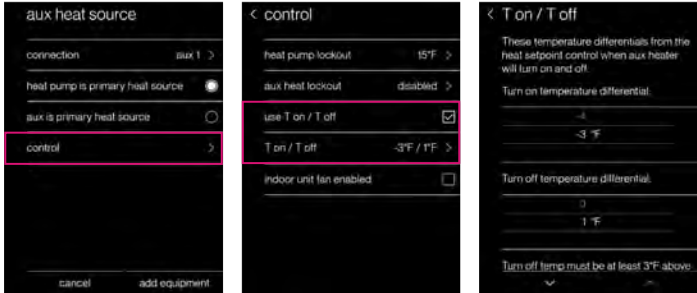

- » Heat pump lockout is adjustable from -20°F to 65°F in 5°F increments. (required, default 15°F)
- » Aux heat lockout is adjustable from -10°F to 75°F in 5°F increments. (optional, default 50°F)
- » Aux heat demand
 - **T on and T off** based control of aux heat demand allows for the following ranges:
 - **T on** differential: -7°F to 3°F in 1°F increments (default 3°F)
 - **T off** differential: -4°F to 1°F in 1°F increments (default 1°F)

Ton/Toff-based control

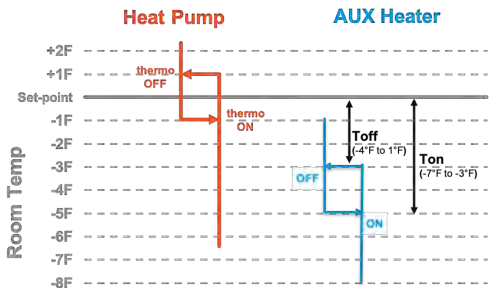

Begin Set-up / Equipment Set-up (cont'd)

Aux Heat as Primary Heat Source

- » The heat pump lockout is adjustable from -20°F to 65°F in 5°F increments. (default 15°F)
- » The set-point differential can be set to -9°F, -7°F, -4°F, and -2°F (default -2°F)
- » Aux heat demand is controlled around the heat setpoint by **T on and T off** with the following ranges:
 - **T on** differential: -1°F to -2°F (default -1°F)
 - **T off** differential: 1°F fixed

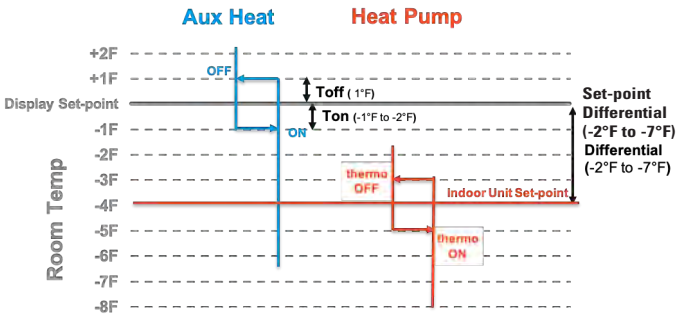

- » With the aux Heater added to an AC outdoor unit, aux as the primary heat source is the only option.
- » In this case, Ton/Toff is also the only control option since there is no HP to control.

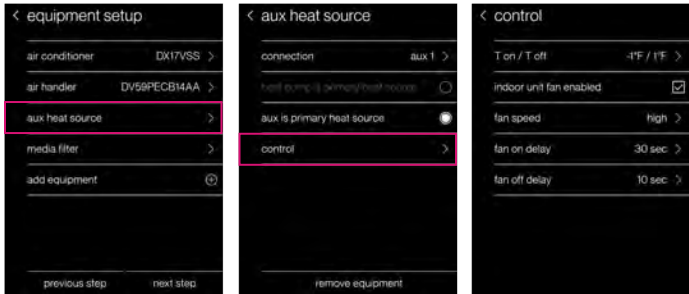

Notes on Aux Heat

- » The aux heat source must always have a self-protection mechanism to turn off if overheating is detected since the indoor unit fan may be turned off unexpectedly for defrost operation or due to a system error.
- » A thermostat aux heat source should not be added to a dual-fuel system (gas furnace with heat pump) or to an air handler with a heater strip. If this is done the thermostat will make a best attempt to control multiple aux heat sources appropriately, but the heat pump lockout may not work as expected.
- » If a thermostat aux heat source is added to a system with a DTA furnace adaptor, fan control should be disabled. The aux heater will be shut down when no fan feedback is received from the DTA adaptor.
- » In an EWC zoning system:
 - An aux heat source that doesn't require the system fan can be configured as either the primary or secondary heat source.
 - If the aux heat source requires the system fan, the heat pump should always be the primary heat source with no heat pump lockout so that the zone damper will be open and the system fan running when the aux heat source is active.
 - If aux is configured as the primary heat source or if the heat pump is locked out, the fan will only run and the zone damper open when no other zone is calling for heating or cooling. This configuration should be avoided.

Begin Set-up / Equipment Set-up (cont'd)

Aux Humidifier and Dehumidifier Wiring

- » Aux dehumidifiers and humidifiers are supported in Unitary systems.
- » The thermostats aux outputs are dry contacts that close the connection to turn on the aux equipment.
- » A 24V AC control signal must be routed through one of the aux contacts of the thermostat.

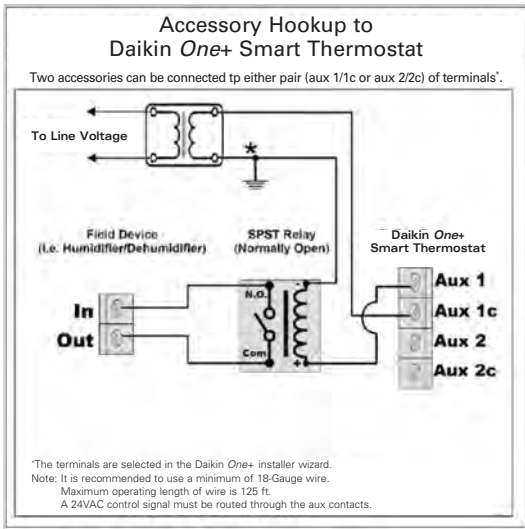

- » An aux humidifier and/or aux dehumidifier can be added to the thermostat in the "Equipment Setup" menu using "add equipment".
 - An aux humidifier controlled directly by the thermostat will generally operate at the same time as any humidifier directly connected to the indoor air handler or gas furnace. Only one humidifier should be associated with a system.
 - An aux dehumidifier controlled directly by the thermostat operates along with any dehumidification function in an air conditioning system.

Aux Humidifier Set-up on the Daikin One+

- » Click on “add equipment” → “aux humidifier”
- » Select “connection” and “aux 1” or “aux 2” as appropriate
- » **Default control:** “on with heat and hum”
- » Select control to change to the “on with heat” or “on with hum” control option, if desired.

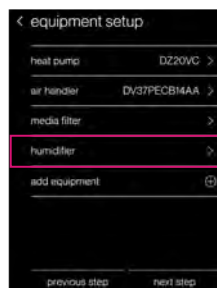
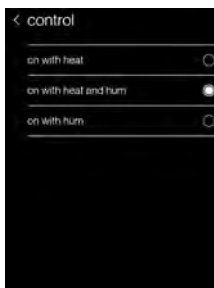
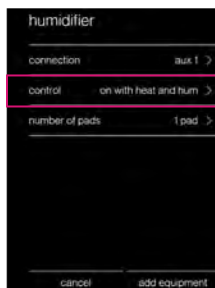
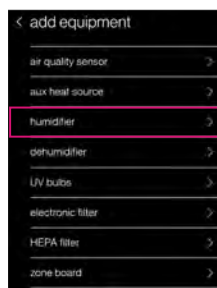
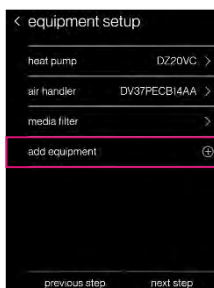
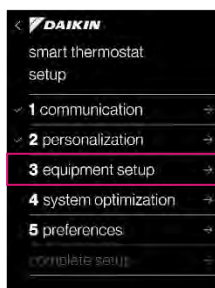

Begin Set-up / Equipment Set-up (cont'd)

Aux Dehumidifier Set-up on the Daikin One+

- » Click on "add equipment" → "dehumidifier"
- » Select "connection" and "aux 1" or "aux 2" as appropriate
- » **Default control:** "on with cool and dehum"
- » Select control to change to the "on with cool" or another control option, if desired.

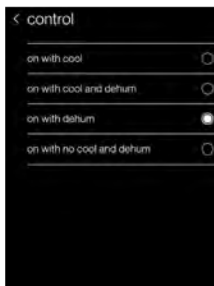
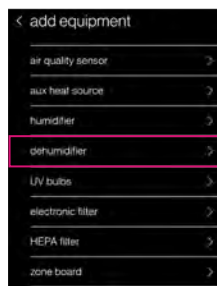
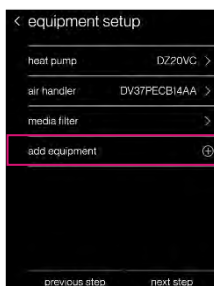
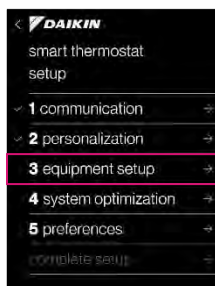

Aux Humidifier and Dehumidifier Operations

- » Aux dehumidifier operation
 - Dehumidification turns on whenever the measured humidity level rises above the dehum set-point.
 - Dehumidification turns off when the measured humidity drops more than 3% below the dehum set-point.
- » Aux humidifier operation
 - Humidification turns on whenever the measured humidity level drops below the hum set-point.
 - Humidification turns off when the measured humidity rises more than 3% above the hum set-point.

Step 4 – System Optimization

System optimization displays:

- » System test.
 - **Inverters only**
- » Charge mode
 - **Inverters only**
- » Optional test
- » Error history
 - Logs alerts with an error code
 - **White = not critical**
 - **Yellow = critical**
- » Calibration
- » Status

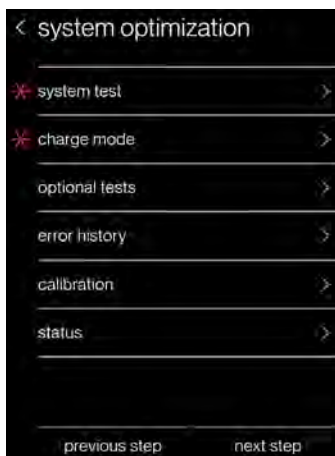
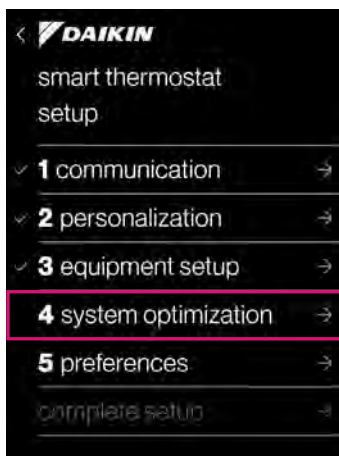

How to Run System Test for Inverter Outdoor Units

Navigate to system optimization > system test > run test

- » On initial power-up the inverter heat pump or air conditioner will display code E11, signaling that initial system test must be run.
- » System test is required to check the equipment settings and functionality.
- » Once selected, it checks the equipment for approximately 10-15 minutes. System test may exceed 15 minutes if there is an error.
- » While the system test is active **“test running”** message shows up on the screen.
- » System test is complete only when display code E11 notice clears from the seven segment LED display on the heat pump or air conditioner. Please wait for test to complete and for code to clear.
- » As soon as the test completes, “test running” message is cleared from the screen.

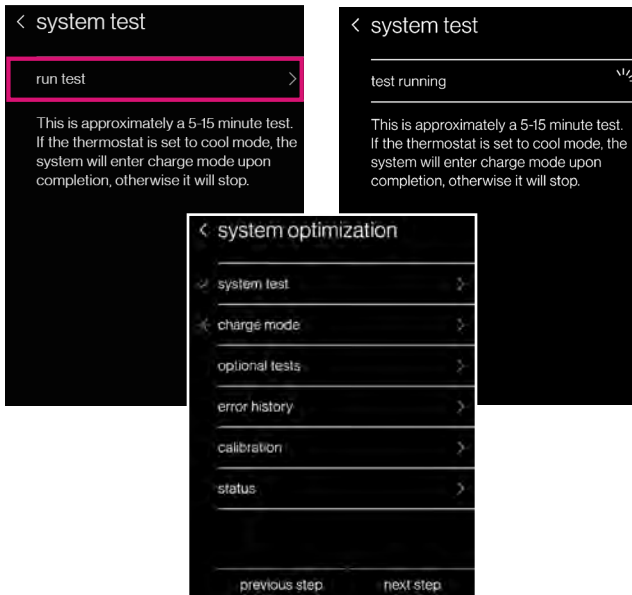

Begin Set-up / System Optimization (cont'd)

How to Use Charge Mode

Navigate to system optimization > charge mode > run test

- » Charge mode allows for the contractor/technician to monitor system performance and top off the charge if needed.
- » System operates for a duration of approximately **one hour** while the equipment runs at full capacity.
- » During this time, the contractor/technician will add vapor refrigerant into the suction line while monitoring system performance. Refrigerant should no longer be charged into the system once performance is correct.
- » After one hour, the charge mode ends and the system resumes normal thermostat operation.
- » To terminate charge mode select 'stop'.

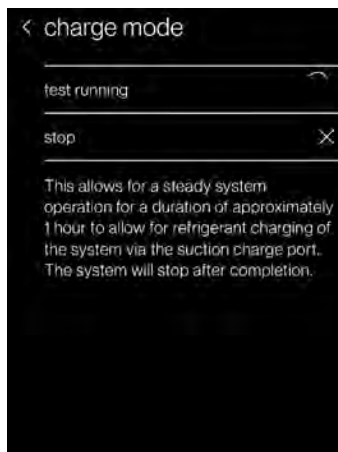
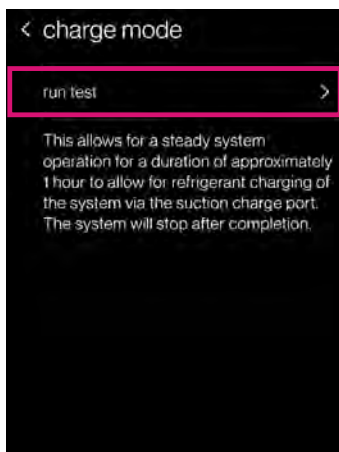

FOR PROPER CHARGING OF A SYSTEM, SEE EQUIPMENT INSTALLATION MANUAL.

How to Calibrate Temperature

Navigate to system optimization > calibration > temperature calibration

- » To calibrate or make adjustment to the thermostat displayed temperature drag the offset up or down.
- » Adjustment can be made -7°F to +7°F in 1°F steps.
- » **Calibration:** thermostat must be in **OFF** mode.
 - Wait 30 minutes before calibration for the thermostat to equalize.

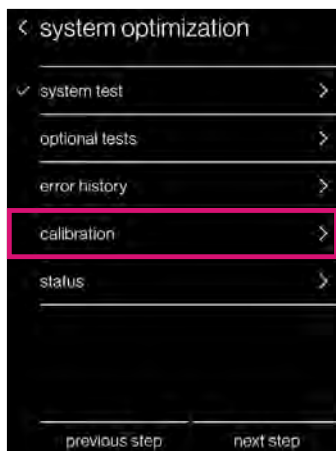

How to Check Error History

Navigate to system optimization > error history

- » Daikin *One+* “error history” menu provides access to the most recent equipment and system errors.
- » Errors are stored in order from most recent to least recent.
- » Each error entry comprises an error code, the equipment type which generated the error, brief error description and a timestamp.
- » Critical errors are displayed with an alert icon with a yellow head.
- » Any consecutively repeated error is stored only once.
- » For more information please refer to Daikin *One+* communicating thermostat documentation.

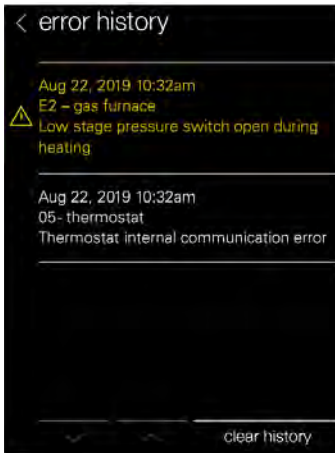

Critical errors are displayed with an alert icon with a yellow head.

How to Check System Operational Information

Navigate to *system optimization > status*

- » The status menu displays data pertaining to the selected equipment
- » The scrollable list can be accessed any time by returning to the installer set-up screen

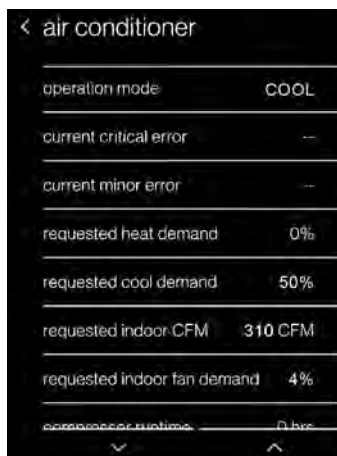
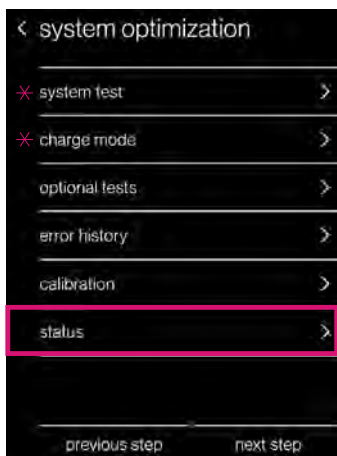

Step 5 – Preferences

There are four preference settings to choose from in order to optimize your systems performance.

- » Cool/Heat
- » House settings
- » Dealer information
- » Reminders

Note: Changing preferences is not required, but reminders and dealer contact information should be input.

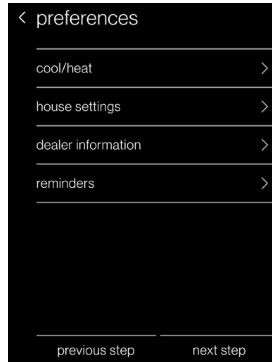
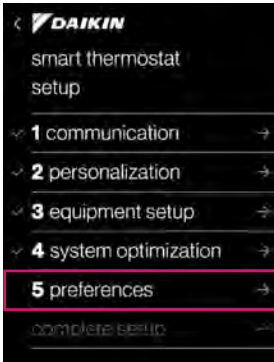

How to Create Reminders

- » The number of reminders available is based on the installed equipment and accessories.
- » Once the equipment has been added, a **1 – 24** month service reminder can be selected for the installed equipment.

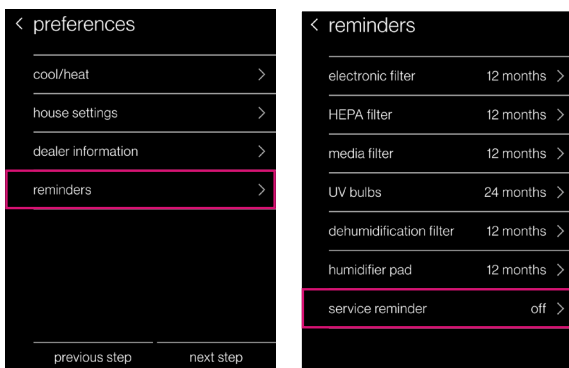

Note: Complete setup shown below.

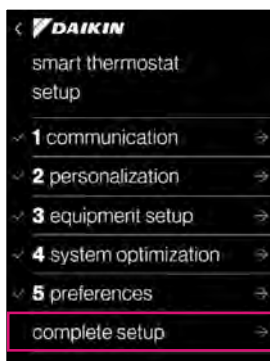

Complete Set-up



Dealer Navigation

How to return to Dealer Edit mode (Begin set-up) Returning to the dealer edit mode will allow you to return to the installer set-up screens to make advanced adjustments to the Daikin One+ and equipment settings.

- » Select the settings menu icon at the top left of the main screen.
- » Scroll to the bottom of the list and select "dealer edit"
- » Select "continue" and enter the 4-digit PIN as shown in the screens below.

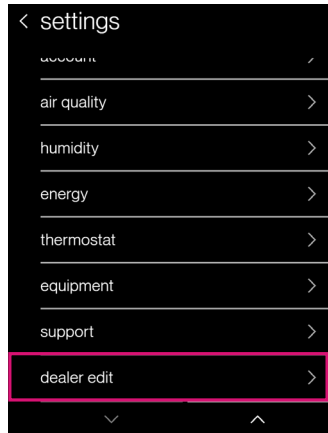

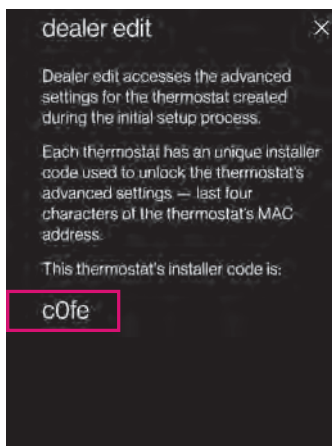
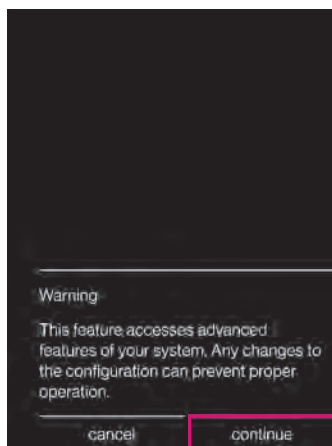

How to Set-up Humidification and Dehumidification Set-points

On the homeowner menu navigate to settings > humidity > target humidity

- » The top value displays the target humidification level.
- » The bottom value displays the target dehumidification level.
- » Drag either value left or right to change the target humidity range.
- » The thermostat attempts to keep the humidity as close as possible to the selected range, using the capabilities of the HVAC equipment installed.

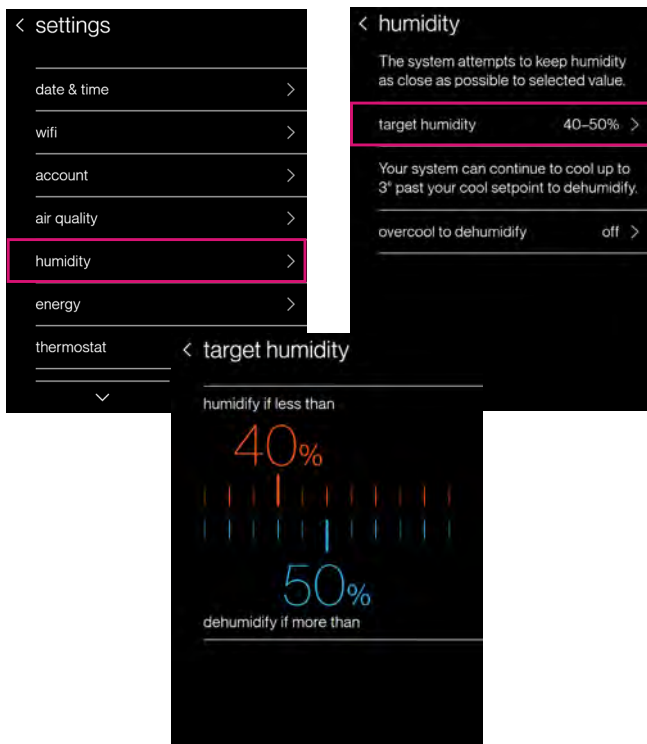

References



1. What are the support resources available?

- a. For general support for the Daikin *One+* smart thermostat – call 1-855-daikin1.
- b. For troubleshooting* and error codes – call 1-855-daikin1 (*For optimal support experience, dealers/installers must be on site before calling our troubleshooting lines).
- c. www.Daikinone.com has resources for homeowners and professionals.
- d. For questions on where to find educational materials – call 1-855-daikin1.
- e. Technical specifications and training content can be found on www.DaikinCity.com.

2. What to do if equipment isn't found during discovery mode?

- a. Find the AHU but not the outdoor unit?
 - i. Ensure wiring is tight, as this may cause dysfunctional systems due to loose wiring at the *One+* mounting plate. Reference back to the wiring troubleshooting section (page 18).

3. How do I connect to Wi-Fi?

- a. You can connect the Daikin *One+* smart thermostat to Wi-Fi by following the steps below. If you have more than one thermostat each one will need to be connected individually.
 - i. Select the menu icon located in the upper right-hand corner section.
 - ii. Select "Settings" and scroll down to "wifi" and select.
 - iii. Ensure the "use wifi" box is checked, then select "networks" to start a scan.
 - iv. Select the wifi network you want to use and enter the password for it.

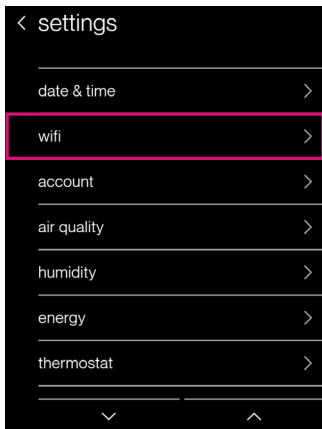

Support and Resources

If you encounter any issues or would like assistance with setting up your Daikin *One+* smart thermostat:

CONTACT DAIKIN SUPPORT AT **1-855-DAIKIN1** TO BE CONNECTED WITH OUR SUPPORT TEAM

Other resources:

- Go to www.daikinone.com and click on the banner to access homeowner site and dealer site for Daikin *One+*

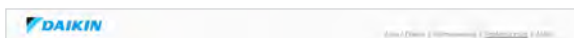

» Homeowner

– Welcome page:

https://www.daikinone.com/smart_thermostats/oneplus/welcome/

- Contains information for homeowner for how to use Daikin *One+* smart thermostat and how to use the mobile app

» Professional (Contractor/Installer)

- Get help at www.daikinone.com/smart_thermostats/oneplus/Pros
- Installation and commissioning information
- Commissioning menu outline
- Wiring diagram, troubleshooting table

» **Daikin *One+*** Installation and Commissioning webinar is also available from Daikin City > Daikin University

- https://youtu.be/_3q_UhF84Xs
- <https://www.youtube.com/user/DaikinAC>

Menu Outline Table of Contents

- » **Daikin One+ Smart Thermostat Commissioning Menu Outline for Unitary equipment is available online:**

https://daikinone.com/smart_thermostats/oneplus/pros/

- the latest thermostat software will download to your thermostat if you connect it to WiFi.



Important Notes

NOTE: This equipment has been tested and found to comply with the limits for a Class B digital device, pursuant to part 15 of the FCC Rules. These limits are designed to provide reasonable protection against harmful interference in a residential installation. This equipment generates uses and can radiate radio frequency energy and, if not installed and used in accordance with the instructions, may cause harmful interference to radio communications. However, there is no guarantee that interference will not occur in a particular installation. If this equipment does cause harmful interference to radio or television reception, which can be determined by turning the equipment off and on, the user is encouraged to try to correct the interference by one or more of the following measures:

- » Reorient or relocate the receiving antenna.
- » Increase the separation between the equipment and receiver.
- » Connect the equipment into an outlet on a circuit different from that to which the receiver is connected.
- » Consult the dealer or an experienced radio/ TV technician for help.

REMARQUE: Cet équipement a été testé et déclaré conforme aux limites imposées aux appareils numériques de classe B, conformément à la section 15 du règlement de la FCC. Ces limites sont conçues pour fournir une protection raisonnable contre les interférences nuisibles dans une installation résidentielle. Cet équipement génère, utilise et peut émettre des fréquences radio et, s'il n'est pas installé et utilisé conformément aux instructions, il peut causer des interférences nuisibles aux radiocommunications. Cependant, rien ne garantit que des interférences ne se produiront pas dans une installation particulière. Si cet équipement provoque des interférences nuisant à la réception de la radio ou de la télévision, ce qui peut être déterminé en éteignant et en rallumant l'équipement, l'utilisateur est invité à tenter de corriger les interférences en appliquant l'une ou plusieurs des mesures suivantes:

- » Réorienter ou déplacer l'antenne de réception.
- » Augmenter la distance entre l'équipement et le récepteur.
- » Connecter l'équipement à une prise d'un circuit différent de celui auquel le récepteur est connecté.
- » Consulter le concessionnaire ou un technicien expérimenté en radio/ télévision pour obtenir de l'aide.

Quick Reference Card Details

Dealers

Install the thermostat

If you need to cover holes in the wall, place the trim plate against the wall first.

Then use the included screws to secure the terminal plate to the wall (sandwiching the trim plate if you're using it).

After connecting the wires, place the top of the thermostat against the terminal plate and press down until it snaps into place.

Get help at:

www.daikinone.com/smart_thermostats/oneplus/Pros

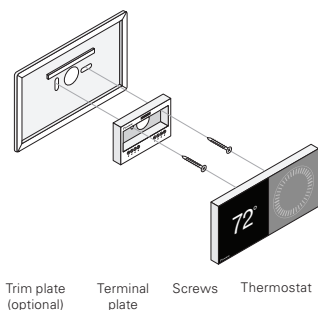

Scanning the bar code on the bottom left corner will link you to a website related to the title of the card.

Homeowners

Install the app to control your smart thermostat from virtually anywhere.



Available on the App Store and Google Play.



Scanning the bar code on the bottom left corner will link you to a website related to the title of the card.

Notes



About Daikin:

Daikin Industries, Ltd. (DIL) is a global Fortune 1000 company and is recognized as one of the largest HVAC (Heating, Ventilation, Air Conditioning) manufacturers in the world. Founded in 1924, Daikin is approaching 100 years of HVAC worldwide leadership. DIL is primarily engaged in developing indoor comfort systems and refrigeration products for residential, commercial, and industrial applications. Its consistent success is derived, in part, from a focus on innovative, energy-efficient, and premium quality indoor climate and comfort management solutions.



www.daikincity.com

For more information:

Sales and Technical Support: 1-855-DAIKIN1

www.daikincomfort.com or daikinac.com



Our continuing commitment to quality products may mean a change in specifications without notice.
© 2023 **DAIKIN COMFORT TECHNOLOGIES NORTH AMERICA, INC.**
Houston, Texas · USA · www.daikincomfort.com or www.daikinac.com

PM-ONE+ ST_11-23