

# Engineering Data

*Pre-sales Literature*

## HSP Concealed Ducted Unit

FXMQ-TBVJU

60 Hz

**R-410A**





# Table of Contents

1. Features and Benefits .....	2
2. Specifications .....	3
3. Dimensions.....	7
4. Center of Gravity .....	11
5. Piping Diagrams .....	12
6. Wiring Diagrams.....	13
7. Electric Characteristics.....	15
8. Safety Devices Setting .....	16
9. Capacity Tables .....	17
9.1 Cooling Capacity at Te: 43°F (6°C).....	17
9.2 Heating Capacity at Tc: 115°F (46°C) .....	17
9.3 Correction Factor for Cooling Capacity at Te: 48°F (9°C).....	18
10. Fan Performance.....	19
11. Airflow Auto Adjustment Characteristics.....	26
12. Sound Levels (Reference Data).....	33
13. Accessories .....	40
13.1 Optional Accessories (for Unit) .....	40
13.2 Optional Accessories (for Controls) .....	40
14. Auxiliary Electric Heater Setting .....	41

## 1. Features and Benefits

The FXMQ\_TBVJU HSP Concealed Ducted unit gives designers a tool to approach even the most cramped air conditioning applications.

- Low profile chassis design measures 9-11/16" (245 mm) deep
- Powerful static pressure capability, with up to 0.8 in.w.g. (200 Pa) external static pressure
- Designed for installation flexibility, with a factory rear-return configuration and field convertible to bottom return
- DC fan motor with Auto\* fan speed control optimizes fan energy use by intelligently controlling the fan speed in response to room temperature conditions
- Ease of installation with auto adjusting airflow at commissioning based on the external static pressure
- Configurable auxiliary heat control allows for high degree of control of heater on/off temperatures
- Integral condensate pump with up to 25-5/16" (643 mm) of lift from the drain outlet
- A maintenance-friendly drain pan inspection port makes it quick and easy to check the conditions of the drain pan.
- Backed by 10 year parts limited warranty\*\*

\*Requires BRC1E73 or intelligent Touch Manager

\*\*Complete warranty details available from local distributor or manufacturer's representative

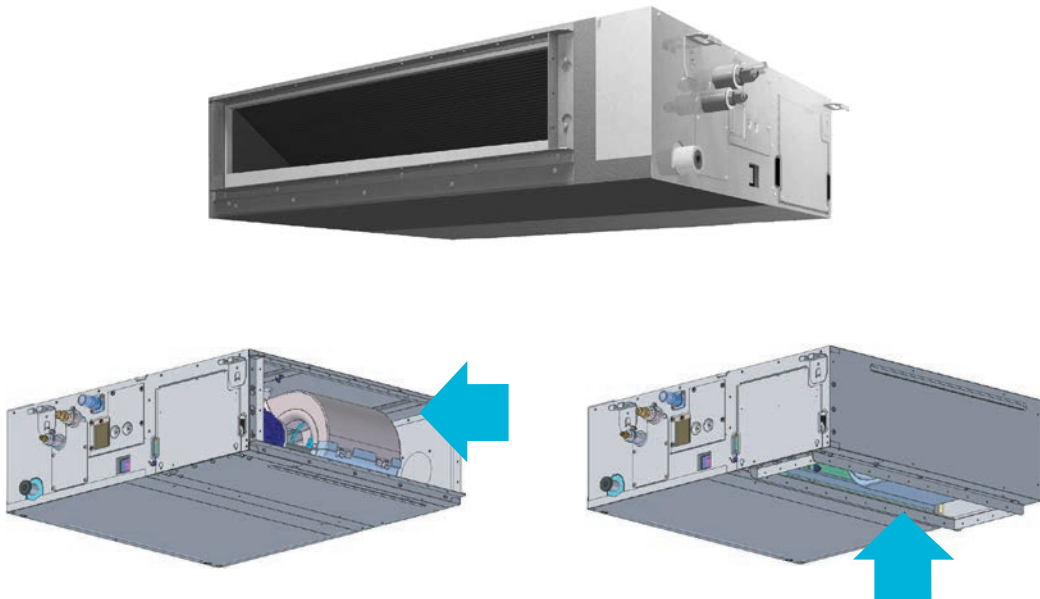

## 2. Specifications

### HSP concealed ducted unit

Model			FXMQ15TBVJU	FXMQ18TBVJU
Power supply			1 phase, 60 Hz, 208/230 V	1 phase, 60 Hz, 208/230 V
★1, ★3 Cooling capacity	Btu/h (kW)		14,200 (4.2)	18,000 (5.3)
★2, ★3 Heating capacity	Btu/h (kW)		17,000 (5.0)	20,000 (5.9)
Casing			Galvanized steel plate	Galvanized steel plate
Dimensions: (H × W × D)		in. (mm)	9-11/16 × 39-3/8 × 31-1/2 (245 × 1,000 × 800)	9-11/16 × 39-3/8 × 31-1/2 (245 × 1,000 × 800)
Coil (cross fin coil)	Rows × Stages × FPI		2 × 26 × 19	2 × 26 × 19
	Face area	ft <sup>2</sup> (m <sup>2</sup> )	3.10 (0.288)	3.10 (0.288)
Fan	Model		—	—
	Type		Sirocco fan	Sirocco fan
	Motor output	Hp (W)	0.31 (230)	0.31 (230)
	Airflow rate (H / M / L)	SCFM (m <sup>3</sup> /min)	560 / 447 / 406 (15.8 / 12.7 / 11.5)	635 / 565 / 512 (18 / 16 / 14.5)
	External static pressure	in. H <sub>2</sub> O (Pa)	Standard 0.40 (0.80-0.20 ★4) (100 (200-50))	Standard 0.40 (0.80-0.20 ★4) (100 (200-50))
	Drive		Direct drive	Direct drive
Temperature control			Microprocessor thermostat for cooling and heating	Microprocessor thermostat for cooling and heating
Sound absorbing thermal insulation material			— ★5	— ★5
★6 Sound pressure level (reference data) (H / M / L)	dBA		37.0 / 34.0 / 31.0	38.0 / 35.0 / 32.0
★6 Sound power level (reference data)	dB		65	66
Weight		lbs (kg)	77 (35)	77 (35)
Piping connections	Liquid pipes	in. (mm)	φ1/4 (φ6.4) (flare connection)	φ1/4 (φ6.4) (flare connection)
	Gas pipes	in. (mm)	φ1/2 (φ12.7) (flare connection)	φ1/2 (φ12.7) (flare connection)
	Drain pipe	in. (mm)	VP25 (external dia. 1-1/4 (32), internal dia. 1 (25))	VP25 (external dia. 1-1/4 (32), internal dia. 1 (25))
Safety devices			Fuse, Fan driver overload protector	Fuse, Fan driver overload protector
Refrigerant control			Electronic expansion valve	Electronic expansion valve
Connectable outdoor unit			R410A VRV series	R410A VRV series
Standard accessories			Operation manual, Installation manual, Drain hose, Sealing material, Clamps, Washers, Screws, Insulation for fitting, Clamp metal, Air discharge flange, Air suction flange, Conduit mounting plate	Operation manual, Installation manual, Drain hose, Sealing material, Clamps, Washers, Screws, Insulation for fitting, Clamp metal, Air discharge flange, Air suction flange, Conduit mounting plate

#### Note:

- ★1. Nominal cooling capacities are based on the following conditions:  
Return air temperature: 80.0°FDB (26.7°CDB), 67.0°FWB (19.4°CWB)  
Outdoor temperature: 95.0°FDB (35.0°CDB)  
Equivalent refrigerant piping length: 25 ft (7.6 m) (horizontal)
- ★2. Nominal heating capacities are based on the following conditions:  
Return air temperature: 70.0°FDB (21.1°CDB)  
Outdoor temperature: 47.0°FDB (8.3°CDB), 43.0°FWB (6.1°CWB)  
Equivalent refrigerant piping length: 25 ft (7.6 m) (horizontal)
- ★3. Capacities are net, including a deduction for cooling (an addition for heating) for indoor fan motor heat.
- ★4. External static pressure is changeable in 14 stages (15-48 type), 10 stages (54 type) within the ( ) range by remote controller.
- ★5. Air filter is not standard accessory, but please mount it in the duct system of the suction side.  
Select its dust collection efficiency (gravity method) 50% or more.
- ★6. Anechoic chamber conversion value, measured under JIS conditions. During actual operation, these values may be higher as a result of installation conditions.

C: 3D140696

## HSP concealed ducted unit

Model		FXMQ24TBVJU	FXMQ30TBVJU
Power supply		1 phase, 60 Hz, 208/230 V	1 phase, 60 Hz, 208/230 V
★1, ★3 Cooling capacity	Btu/h (kW)	24,000 (7.0)	30,000 (8.8)
★2, ★3 Heating capacity	Btu/h (kW)	27,000 (7.9)	34,000 (10.0)
Casing		Galvanized steel plate	Galvanized steel plate
Dimensions: (H × W × D)		in. (mm) 9-11/16 × 39-3/8 × 31-1/2 (245 × 1,000 × 800)	9-11/16 × 55-1/8 × 31-1/2 (245 × 1,400 × 800)
Coil (cross fin coil)	Rows × Stages × FPI	3 × 26 × 19	2 × 26 × 19
	Face area	ft <sup>2</sup> (m <sup>2</sup> ) 3.10 (0.288)	3.10 (0.288)
Fan	Model	—	—
	Type	Sirocco fan	Sirocco fan
	Motor output	Hp (W) 0.31 (230)	0.49 (364)
	Airflow rate (H / M / L)	SCFM (m <sup>3</sup> /min) 742 / 635 / 565 (21 / 18 / 16)	1,094 / 847 / 795 (31 / 24 / 22.5)
	External static pressure	in. H <sub>2</sub> O (Pa) Standard 0.40 (0.80-0.20 ★4) (100 (200-50))	Standard 0.40 (0.80-0.20 ★4) (100 (200-50))
	Drive	Direct drive	Direct drive
Temperature control		Microprocessor thermostat for cooling and heating	Microprocessor thermostat for cooling and heating
Sound absorbing thermal insulation material		— ★5	— ★5
★6 Sound pressure level (reference data) (H / M / L)	dBA	39.0 / 35.0 / 33.0	43.0 / 38.0 / 36.0
★6 Sound power level (reference data)	dB	67	71
Weight		lbs (kg) 82 (37)	101 (46)
Piping connections	Liquid pipes	in. (mm) φ3/8 (φ9.5) (flare connection)	φ3/8 (φ9.5) (flare connection)
	Gas pipes	in. (mm) φ5/8 (φ15.9) (flare connection)	φ5/8 (φ15.9) (flare connection)
	Drain pipe	in. (mm) VP25 (external dia. 1-1/4 (32), internal dia. 1 (25))	VP25 (external dia. 1-1/4 (32), internal dia. 1 (25))
Safety devices		Fuse, Fan driver overload protector	Fuse, Fan driver overload protector
Refrigerant control		Electronic expansion valve	Electronic expansion valve
Connectable outdoor unit		R410A VRV series	R410A VRV series
Standard accessories		Operation manual, Installation manual, Drain hose, Sealing material, Clamps, Washers, Screws, Insulation for fitting, Clamp metal, Air discharge flange, Air suction flange, Conduit mounting plate	Operation manual, Installation manual, Drain hose, Sealing material, Clamps, Washers, Screws, Insulation for fitting, Clamp metal, Air discharge flange, Air suction flange, Conduit mounting plate

## Note:

- ★1. Nominal cooling capacities are based on the following conditions:  
Return air temperature: 80.0°FDB (26.7°CDB), 67.0°FWB (19.4°CWB)  
Outdoor temperature: 95.0°FDB (35.0°CDB)  
Equivalent refrigerant piping length: 25 ft (7.6 m) (horizontal)
- ★2. Nominal heating capacities are based on the following conditions:  
Return air temperature: 70.0°FDB (21.1°CDB)  
Outdoor temperature: 47.0°FDB (8.3°CDB), 43.0°FWB (6.1°CWB)  
Equivalent refrigerant piping length: 25 ft (7.6 m) (horizontal)
- ★3. Capacities are net, including a deduction for cooling (an addition for heating) for indoor fan motor heat.
- ★4. External static pressure is changeable in 14 stages (15-48 type), 10 stages (54 type) within the ( ) range by remote controller.
- ★5. Air filter is not standard accessory, but please mount it in the duct system of the suction side.  
Select its dust collection efficiency (gravity method) 50% or more.
- ★6. Anechoic chamber conversion value, measured under JIS conditions. During actual operation, these values may be higher as a result of installation conditions.

C: 3D140696

## HSP concealed ducted unit

Model		FXMQ36TBVJU	FXMQ48TBVJU
Power supply		1 phase, 60 Hz, 208/230 V	1 phase, 60 Hz, 208/230 V
★1, ★3 Cooling capacity	Btu/h (kW)	36,000 (10.6)	48,000 (14.1)
★2, ★3 Heating capacity	Btu/h (kW)	40,000 (11.7)	54,000 (15.8)
Casing		Galvanized steel plate	Galvanized steel plate
Dimensions: (H × W × D)		in. (mm) 9-11/16 × 55-1/8 × 31-1/2 (245 × 1,400 × 800)	9-11/16 × 55-1/8 × 31-1/2 (245 × 1,400 × 800)
Coil (cross fin coil)	Rows × Stages × FPI	2 × 26 × 19	3 × 26 × 19
	Face area	ft <sup>2</sup> (m <sup>2</sup> ) 4.66 (0.433)	4.66 (0.433)
Fan	Model	—	—
	Type	Sirocco fan	Sirocco fan
	Motor output	Hp (W) 0.49 (364)	0.49 (364)
	Airflow rate (H / M / L)	SCFM (m <sup>3</sup> /min) 1,130 / 953 / 795 (32 / 27 / 22.5)	1,377 / 1,130 / 918 (39 / 32 / 26)
	External static pressure	in. H <sub>2</sub> O (Pa) Standard 0.40 (0.80-0.20 ★4) (100 (200-50))	Standard 0.40 (0.80-0.20 ★4) (100 (200-50))
	Drive	Direct drive	Direct drive
Temperature control		Microprocessor thermostat for cooling and heating	Microprocessor thermostat for cooling and heating
Sound absorbing thermal insulation material		— ★5	— ★5
★6 Sound pressure level (reference data) (H / M / L)	dBA	44.0 / 40.0 / 36.0	48.0 / 44.0 / 39.0
★6 Sound power level (reference data)	dB	72	76
Weight	lbs (kg)	101 (46)	104 (47)
Piping connections	Liquid pipes	in. (mm) ϕ3/8 (ϕ9.5) (flare connection)	ϕ3/8 (ϕ9.5) (flare connection)
	Gas pipes	in. (mm) ϕ5/8 (ϕ15.9) (flare connection)	ϕ5/8 (ϕ15.9) (flare connection)
	Drain pipe	in. (mm) VP25 (external dia. 1-1/4 (32), internal dia. 1 (25))	VP25 (external dia. 1-1/4 (32), internal dia. 1 (25))
Safety devices		Fuse, Fan driver overload protector	Fuse, Fan driver overload protector
Refrigerant control		Electronic expansion valve	Electronic expansion valve
Connectable outdoor unit		R410A VRV series	R410A VRV series
Standard accessories		Operation manual, Installation manual, Drain hose, Sealing material, Clamps, Washers, Screws, Insulation for fitting, Clamp metal, Air discharge flange, Air suction flange, Conduit mounting plate	Operation manual, Installation manual, Drain hose, Sealing material, Clamps, Washers, Screws, Insulation for fitting, Clamp metal, Air discharge flange, Air suction flange, Conduit mounting plate

**Note:**

- ★1. Nominal cooling capacities are based on the following conditions:  
Return air temperature: 80.0°FDB (26.7°CDB), 67.0°FWB (19.4°CWB)  
Outdoor temperature: 95.0°FDB (35.0°CDB)  
Equivalent refrigerant piping length: 25 ft (7.6 m) (horizontal)
- ★2. Nominal heating capacities are based on the following conditions:  
Return air temperature: 70.0°FDB (21.1°CDB)  
Outdoor temperature: 47.0°FDB (8.3°CDB), 43.0°FWB (6.1°CWB)  
Equivalent refrigerant piping length: 25 ft (7.6 m) (horizontal)
- ★3. Capacities are net, including a deduction for cooling (an addition for heating) for indoor fan motor heat.
- ★4. External static pressure is changeable in 14 stages (15-48 type), 10 stages (54 type) within the ( ) range by remote controller.
- ★5. Air filter is not standard accessory, but please mount it in the duct system of the suction side.  
Select its dust collection efficiency (gravity method) 50% or more.
- ★6. Anechoic chamber conversion value, measured under JIS conditions. During actual operation, these values may be higher as a result of installation conditions.

C: 3D140696

## HSP concealed ducted unit

Model		FXMQ54TBVJU	
Power supply		1 phase, 60 Hz, 208/230 V	
★1, ★3 Cooling capacity	Btu/h (kW)	57,000 (16.7)	
★2, ★3 Heating capacity	Btu/h (kW)	60,000 (18.5)	
Casing		Galvanized steel plate	
Dimensions: (H × W × D)		in. (mm)	
		9-11/16 × 61 × 31-1/2 (245 × 1,550 × 800)	
Coil (cross fin coil)	Rows × Stages × FPI		3 × 26 × 19
	Face area	ft <sup>2</sup> (m <sup>2</sup> )	5.25 (0.488)
Fan	Model		—
	Type		Sirocco fan
	Motor output	Hp (W)	0.47 (350)
	Airflow rate (H / M / L)	SCFM (m <sup>3</sup> /min)	1,518 / 1,235 / 989 (43 / 35 / 28)
	External static pressure	in. H <sub>2</sub> O (Pa)	Standard 0.40 (0.56-0.20 ★4) (100 (140-50))
	Drive		Direct drive
Temperature control		Microprocessor thermostat for cooling and heating	
Sound absorbing thermal insulation material		— ★5	
★6 Sound pressure level (reference data) (H / M / L)	dBA	52.0 / 47.0 / 42.0	
★6 Sound power level (reference data)	dB	80	
Weight		lbs (kg)	
		115 (52)	
Piping connections	Liquid pipes	in. (mm)	φ3/8 (φ9.5) (flare connection)
	Gas pipes	in. (mm)	φ5/8 (φ15.9) (flare connection)
	Drain pipe	in. (mm)	VP25 (external dia. 1-1/4 (32), internal dia. 1 (25))
Safety devices		Fuse, Fan driver overload protector	
Refrigerant control		Electronic expansion valve	
Connectable outdoor unit		R410A VRV series	
Standard accessories		Operation manual, Installation manual, Drain hose, Sealing material, Clamps, Washers, Screws, Insulation for fitting, Clamp metal, Air discharge flange, Air suction flange, Conduit mounting plate	

**Note:**

- ★1. Nominal cooling capacities are based on the following conditions:  
Return air temperature: 80.0°FDB (26.7°CDB), 67.0°FWB (19.4°CWB)  
Outdoor temperature: 95.0°FDB (35.0°CDB)  
Equivalent refrigerant piping length: 25 ft (7.6 m) (horizontal)
- ★2. Nominal heating capacities are based on the following conditions:  
Return air temperature: 70.0°FDB (21.1°CDB).  
Outdoor temperature: 47.0°FDB (8.3°CDB), 43.0°FWB (6.1°CWB)  
Equivalent refrigerant piping length: 25 ft (7.6 m) (horizontal)
- ★3. Capacities are net, including a deduction for cooling (an addition for heating) for indoor fan motor heat.
- ★4. External static pressure is changeable in 14 stages (15-48 type), 10 stages (54 type) within the ( ) range by remote controller.
- ★5. Air filter is not standard accessory, but please mount it in the duct system of the suction side.  
Select its dust collection efficiency (gravity method) 50% or more.
- ★6. Anechoic chamber conversion value, measured under JIS conditions. During actual operation, these values may be higher as a result of installation conditions.

C: 3D140696



### 3. Dimensions

#### FXMQ15-18TBVJU

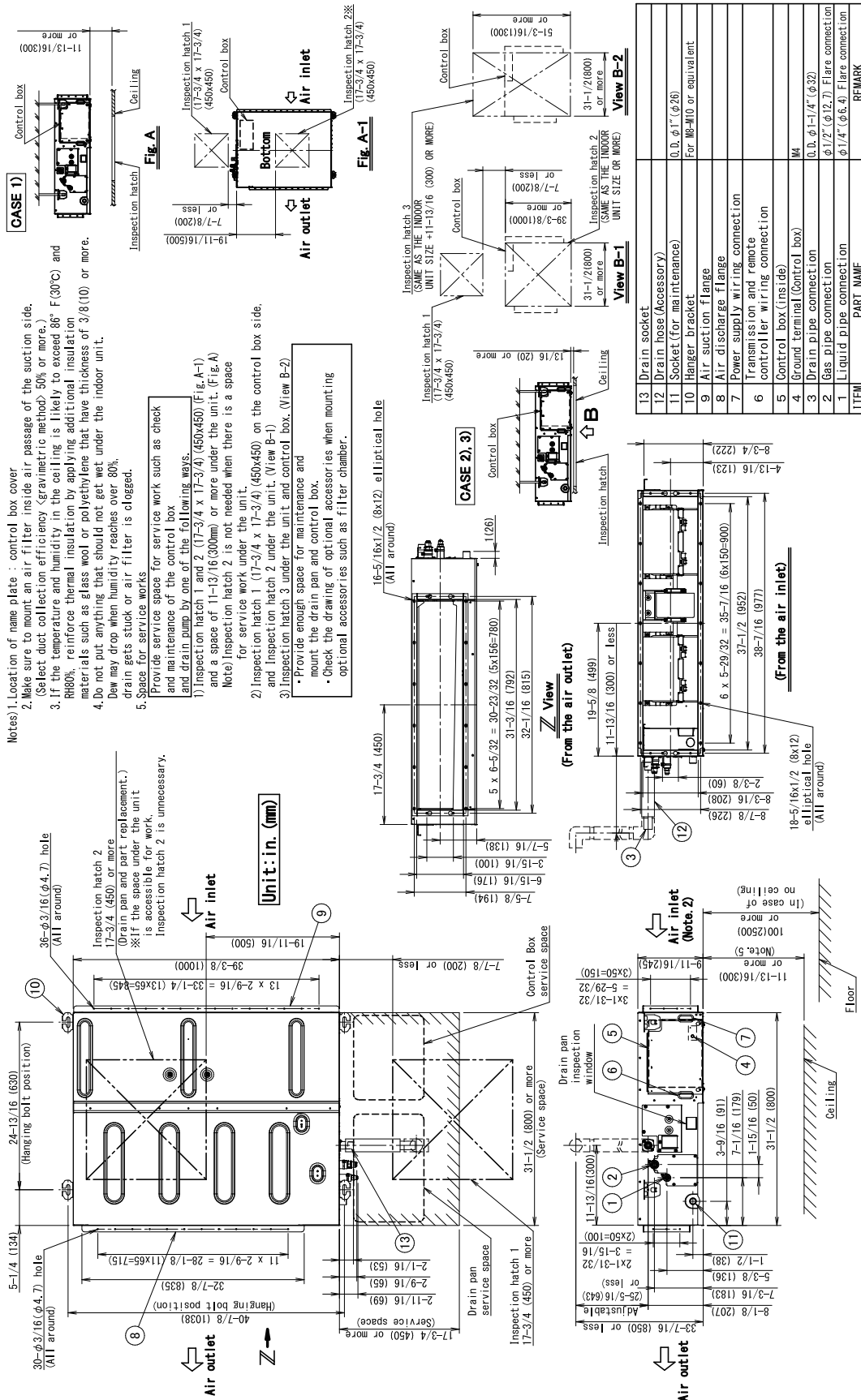

3D140722

FXMQ24TBVJU

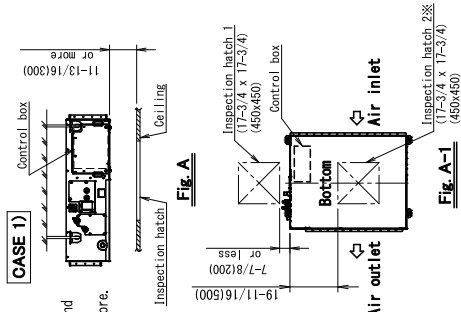

**Notes)** 1. Location of name plate : control box cover  
 2. Make sure to mount an air filter inside air passage of the suction side.  
 (Select duct collection efficiency (gravimetric method) 50% or more.)  
 3. If the temperature and humidity in the ceiling is likely to exceed 86° F (30°C) and RH80%, reinforce thermal insulation by applying additional insulation materials such as glass wool or polyethylene that have thickness of 3/8(10) or more.  
 4. Do not put anything that should not get wet under the indoor unit.  
 Dew may drop when humidity reaches over 80%.  
 Drain gets stuck or air filter is clogged.  
 5. Space for service works  
 Provide service space for service work such as check and maintenance of the control box and drain pump by one of the following ways.  
 1) Inspection hatch 1 and 2 (17-3/4 x 17-3/4) (450x450) (Fig. A-1) and a space of 11-13/16(300mm) or more under the unit. (Fig. A) Note) Inspection hatch 2 is not needed when there is a space for service work under the unit.  
 2) Inspection hatch 1 (17-3/4 x 17-3/4) (450x450) on the control box side, and Inspection hatch 2 under the unit. (View B-1)  
 3) Inspection hatch 3 under the unit and control box. (View B-2)  
 • Provide enough space for maintenance and mount the drain pan and control box.  
 • Check the drawing of optional accessories when mounting optional accessories such as filter chamber.

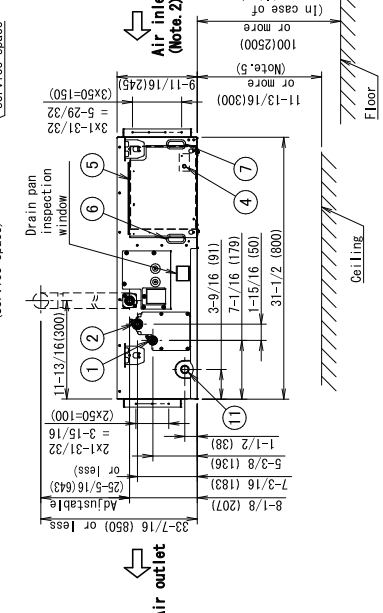
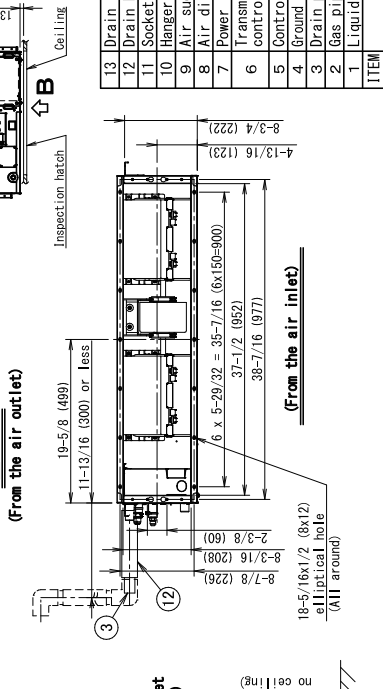
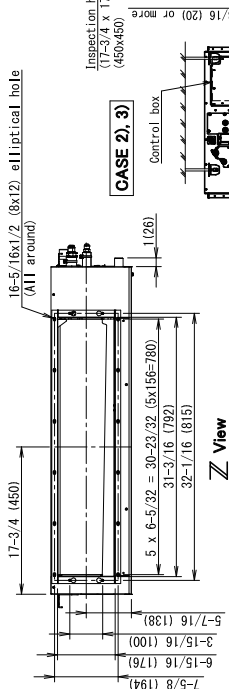
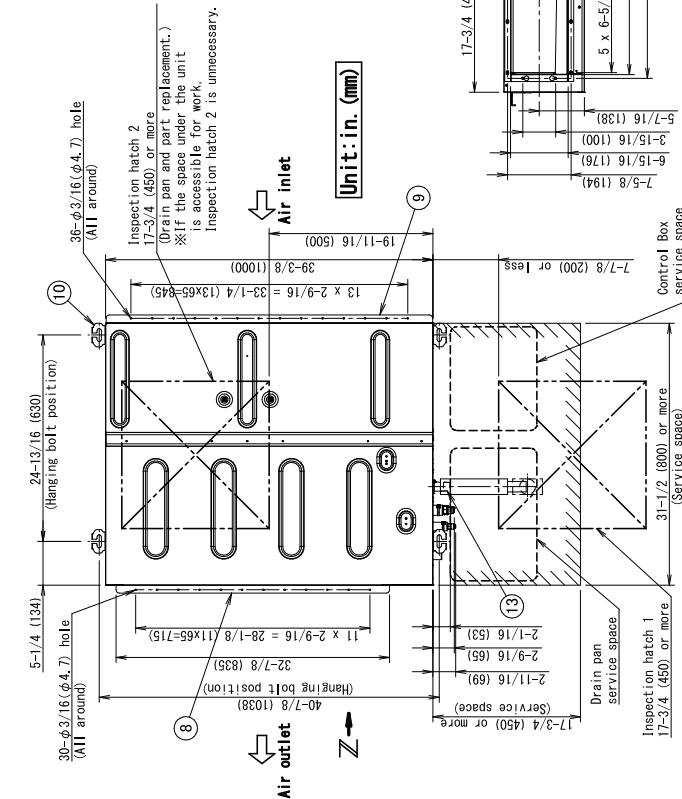

ITEM	PART NAME	REMARK
13	Drain socket	
12	Drain hose (Accessory)	
11	Socket (for maintenance)	O.D. $\phi$ 1" ( $\phi$ 25)
10	Hanger bracket	For M $\phi$ -M10 or equivalent
9	Air suction flange	
8	Air discharge flange	
7	Power supply wiring connection	
6	Transmission and remote controller wiring connection	
5	Control box (inside)	M
4	Ground terminal (control box)	
3	Drain pipe connection	O.D. $\phi$ 1-1/4" ( $\phi$ 32)
2	Gas pipe connection	$\phi$ 5/8" ( $\phi$ 15.9) Flare connection
1	Liquid pipe connection	$\phi$ 3/8" ( $\phi$ 9.5) Flare connection

3D140723

# FXMQ30-48TBVJU

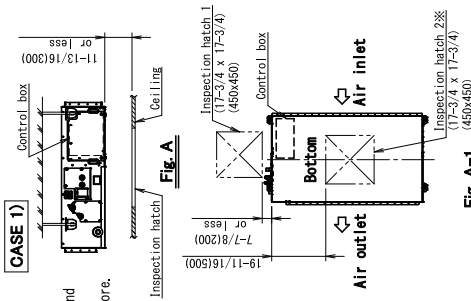

Fig. A-1

- Notes) 1. Location of name plate : control box cover  
 2. Make sure to mount an air filter inside air passage of the suction side.  
 3. (Select duct collection efficiency (gravimetric method) 50% or more.)  
 4. If the temperature and humidity in the ceiling is likely to exceed 86° F (30°C) and RH80%, reinforce thermal insulation by applying additional insulation materials such as glass wool or polyethylene that have thickness of 3.8(10) or more.  
 5. Do not put anything that should not get wet under the indoor unit.  
 6. Dew may drop when humidity reaches over 80%.  
 7. Drain gets stuck or air filter is clogged.  
 8. Space for service works  
 9. Provide service space for service work such as check and maintenance of the control box and drain pump by one of the following ways.  
 10) Inspection hatch 1 and 2 (17-3/4 x 17-3/4) (450x450) (Fig. A-1) and a space of 11-13/16 (300mm) or more under the unit. (Fig. A) (Note) Inspection hatch 2 is not needed when there is a space for service work under the unit.  
 11) Inspection hatch 1 (17-3/4 x 17-3/4) (450x450) on the control box side.  
 12) Inspection hatch 2 under the unit. (View B-1) and Inspection hatch 3 under the unit and control box. (View B-2)  
 13) Provide enough space for maintenance and mount the drain pan and control box.  
 14) Check the drawing of optional accessories when mounting optional accessories such as filter chamber.

- Unit: in. (mm)
- 1) 50-φ3/16 (φ4.7) hole (All around)
  - 2) Inspection hatch 2 (17-3/4 (450) or more (Drain pan and part replacement.) ※ If the space under the unit is accessible for work, inspection hatch 2 is unnecessary.
  - 3) 20-5/16x1/2 (8x12) elliptical hole (All around)
  - 4) 25-9/16 (650)
  - 5) 7 x 6-5/32 = 43 (7x156-1092)
  - 6) 46-15/16 (1192)
  - 7) 47-13/16 (1215)
  - 8) 1(26)
  - 9) 13/16 (20) or more
  - 10) 17-3/4 x 17-3/4 (450x450)
  - 11) 1(26)
  - 12) 13/16 (20) or more
  - 13) 20-5/16x1/2 (8x12) elliptical hole (All around)

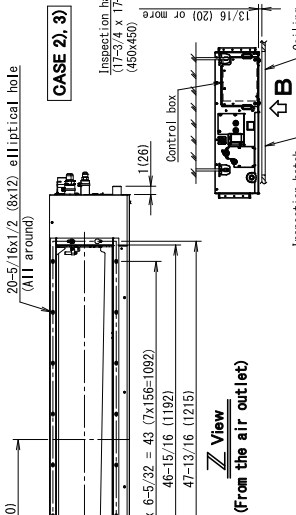

Fig. A-2

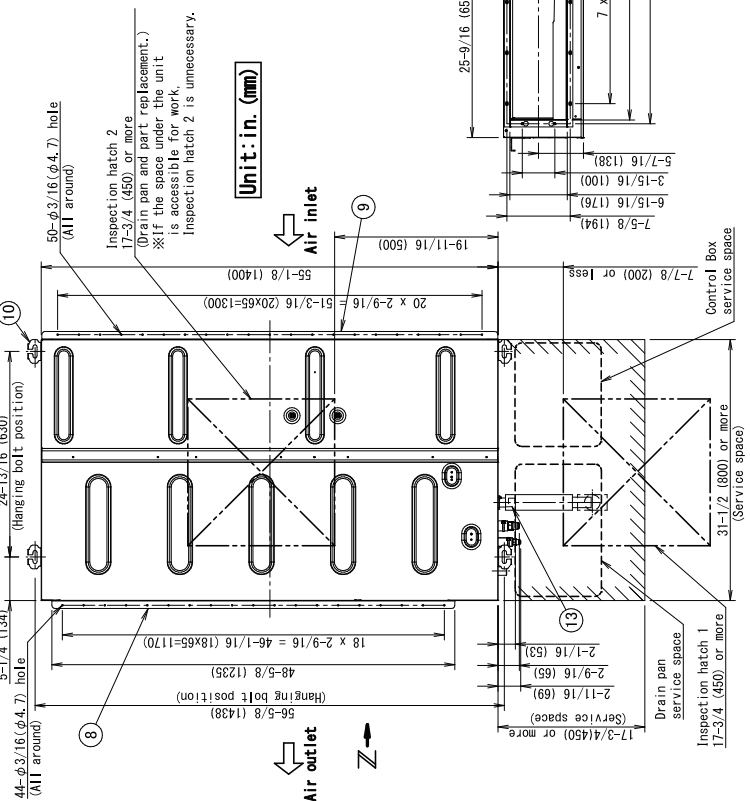

Fig. B-1

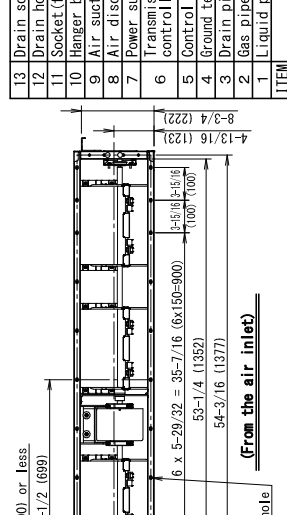

Fig. B-2

ITEM	PART NAME	REMARK
13	Drain socket	
12	Drain hose (Accessory)	0.0. φ1" (φ26)
11	Socket (for maintenance)	For M8-M10 or equivalent
10	Hanger bracket	
9	Air suction flange	
8	Air discharge flange	
7	Power supply wiring connection	
6	Transmission and remote controller wiring connection	
5	Control box (inside)	M4
4	Ground terminal (control box)	0.0. φ1-1/4" (φ32)
3	Drain pipe connection	φ5.8" (φ15.9) Flare connection
2	Gas pipe connection	φ3.8" (φ9.5) Flare connection
1	Liquid pipe connection	

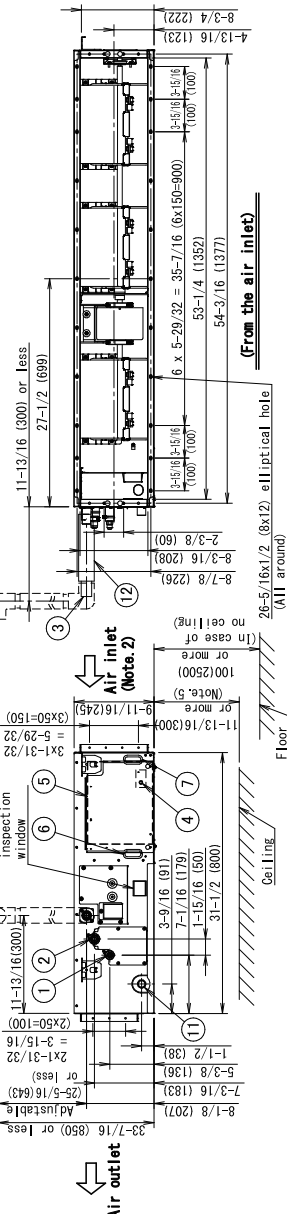
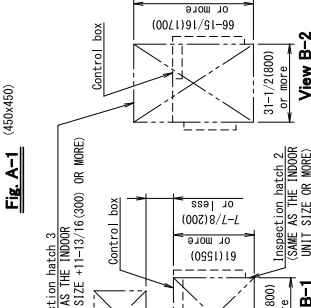
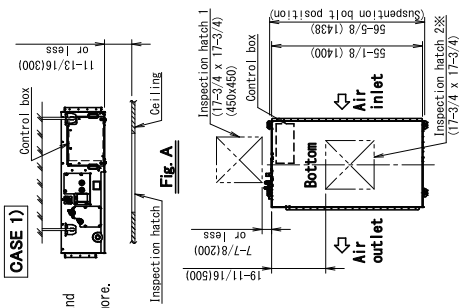
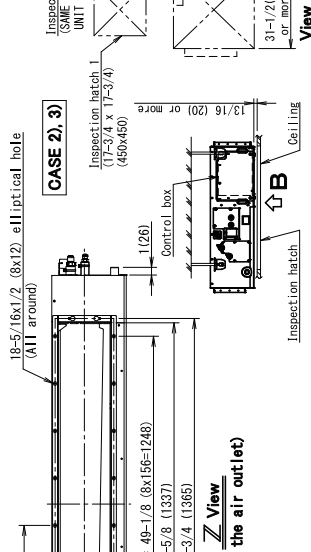
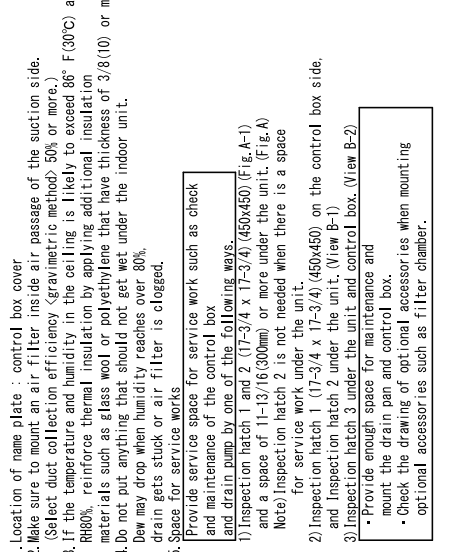

Fig. C

FXMQ54TBVJU



ITEM	PART NAME	REMARK
13	Drain socket	
12	Drain hose (Accessory)	0.6" φ (1.6)
11	Socket (for maintenance)	For M6-M10 or equivalent
10	Hanger bracket	
9	Air suction flange	
8	Air discharge flange	
7	Power supply wiring connection	
6	Transmission and remote controller wiring connection	
5	Control box (inside)	NA
4	Ground terminal (Control box)	0.6" φ - 1/4" (φ32)
3	Drain pipe connection	φ5.8" (φ15.9) Flare connection
2	Gas pipe connection	φ3.8" (φ9.5) Flare connection
1	Liquid pipe connection	



ITEM	PART NAME	REMARK
13	Drain socket	
12	Drain hose (Accessory)	0.6" φ (1.6)
11	Socket (for maintenance)	For M6-M10 or equivalent
10	Hanger bracket	
9	Air suction flange	
8	Air discharge flange	
7	Power supply wiring connection	
6	Transmission and remote controller wiring connection	
5	Control box (inside)	NA
4	Ground terminal (Control box)	0.6" φ - 1/4" (φ32)
3	Drain pipe connection	φ5.8" (φ15.9) Flare connection
2	Gas pipe connection	φ3.8" (φ9.5) Flare connection
1	Liquid pipe connection	

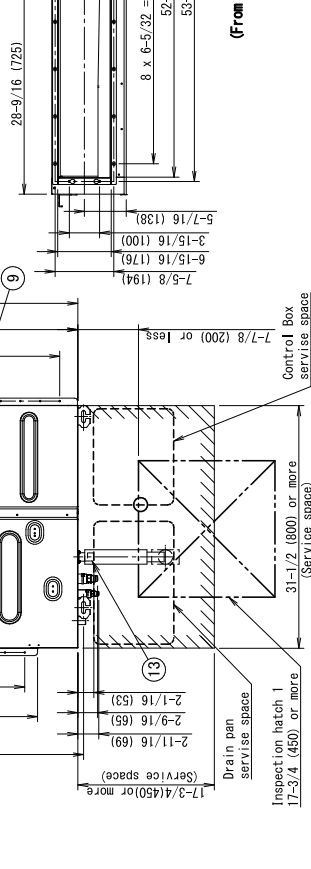
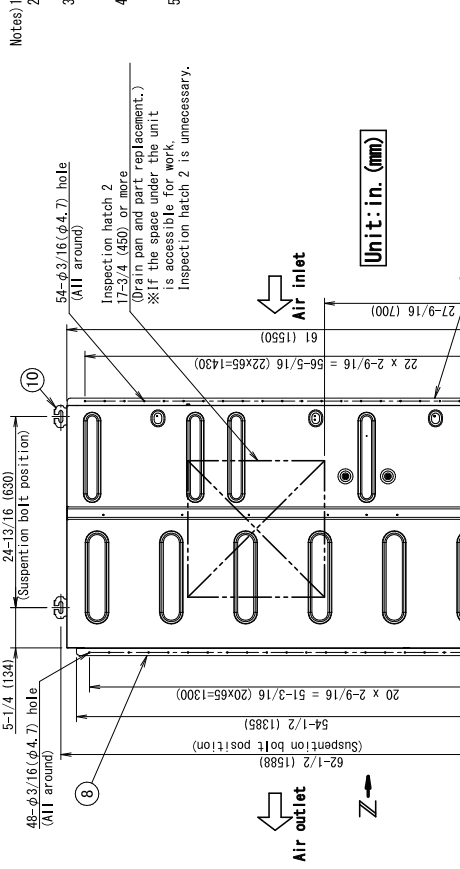

ITEM	PART NAME	REMARK
13	Drain socket	
12	Drain hose (Accessory)	0.6" φ (1.6)
11	Socket (for maintenance)	For M6-M10 or equivalent
10	Hanger bracket	
9	Air suction flange	
8	Air discharge flange	
7	Power supply wiring connection	
6	Transmission and remote controller wiring connection	
5	Control box (inside)	NA
4	Ground terminal (Control box)	0.6" φ - 1/4" (φ32)
3	Drain pipe connection	φ5.8" (φ15.9) Flare connection
2	Gas pipe connection	φ3.8" (φ9.5) Flare connection
1	Liquid pipe connection	

Notes) 1. Location of name plate : control box cover  
 2. Make sure to mount an air filter inside air passage of the suction side.  
 (Select duct collection efficiency (gravimetric method) 50% or more.)  
 3. If the temperature and humidity in the ceiling is likely to exceed 86° F (30°C) and RH80%, reinforce thermal insulation by applying additional insulation materials such as glass wool or polyethylene that have thickness of 3/8(10) or more.  
 4. Do not put anything that should not get wet under the indoor unit.  
 Dew may drop when humidity reaches over 80%.  
 drain gets stuck or air filter is clogged.  
 5. Space for service works  
 Provide service space for service work such as check and maintenance of the control box and drain pump by one of the following ways.  
 1) Inspection hatch 1 and 2 (17-3/4 x 17-3/4) (450x450) (Fig. A-1) and a space of 1-13/16 (300mm) or more under the unit. (Fig. A) (Note) Inspection hatch 2 is not needed when there is a space for service work under the unit.  
 2) Inspection hatch 1 (17-3/4 x 17-3/4) (450x450) on the control box side, and Inspection hatch 2 under the unit. (View B-1)  
 3) Inspection hatch 3 under the unit and control box. (View B-2)  
 • Provide enough space for maintenance and mount the drain pan and control box.  
 • Check the drawing of optional accessories when mounting optional accessories such as filter chamber.

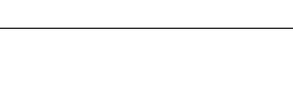
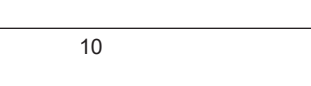

ITEM	PART NAME	REMARK
13	Drain socket	
12	Drain hose (Accessory)	0.6" φ (1.6)
11	Socket (for maintenance)	For M6-M10 or equivalent
10	Hanger bracket	
9	Air suction flange	
8	Air discharge flange	
7	Power supply wiring connection	
6	Transmission and remote controller wiring connection	
5	Control box (inside)	NA
4	Ground terminal (Control box)	0.6" φ - 1/4" (φ32)
3	Drain pipe connection	φ5.8" (φ15.9) Flare connection
2	Gas pipe connection	φ3.8" (φ9.5) Flare connection
1	Liquid pipe connection	

### 4. Center of Gravity

FXMQ15-54TBVJU

in. (mm)

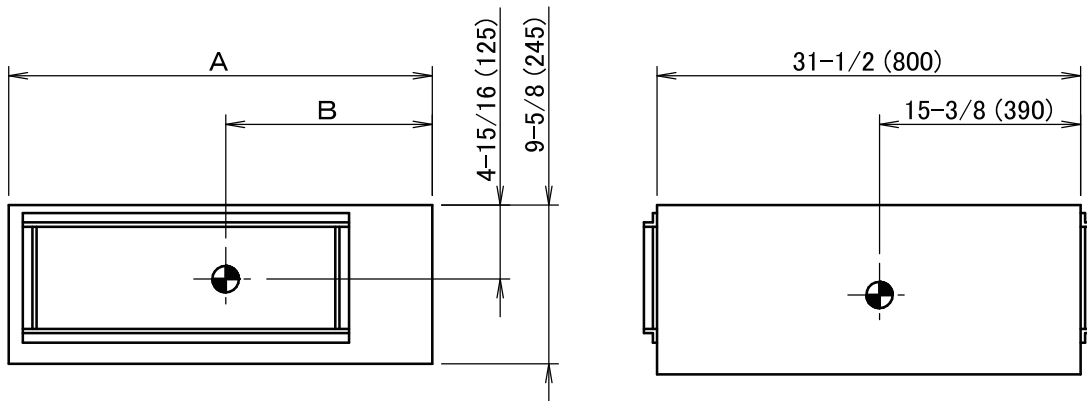

MODEL NAME	A	B
FXMQ15 · 18 · 24TBVJU	39-3/8 (1000)	18-11/16 (475)
FXMQ30 · 36 · 48TBVJU	55-1/8 (1400)	24-7/16 (620)
FXMQ54TBVJU	61 (1550)	26-15/16 (685)

# 5. Piping Diagrams

## FXMQ15-54TBVJU

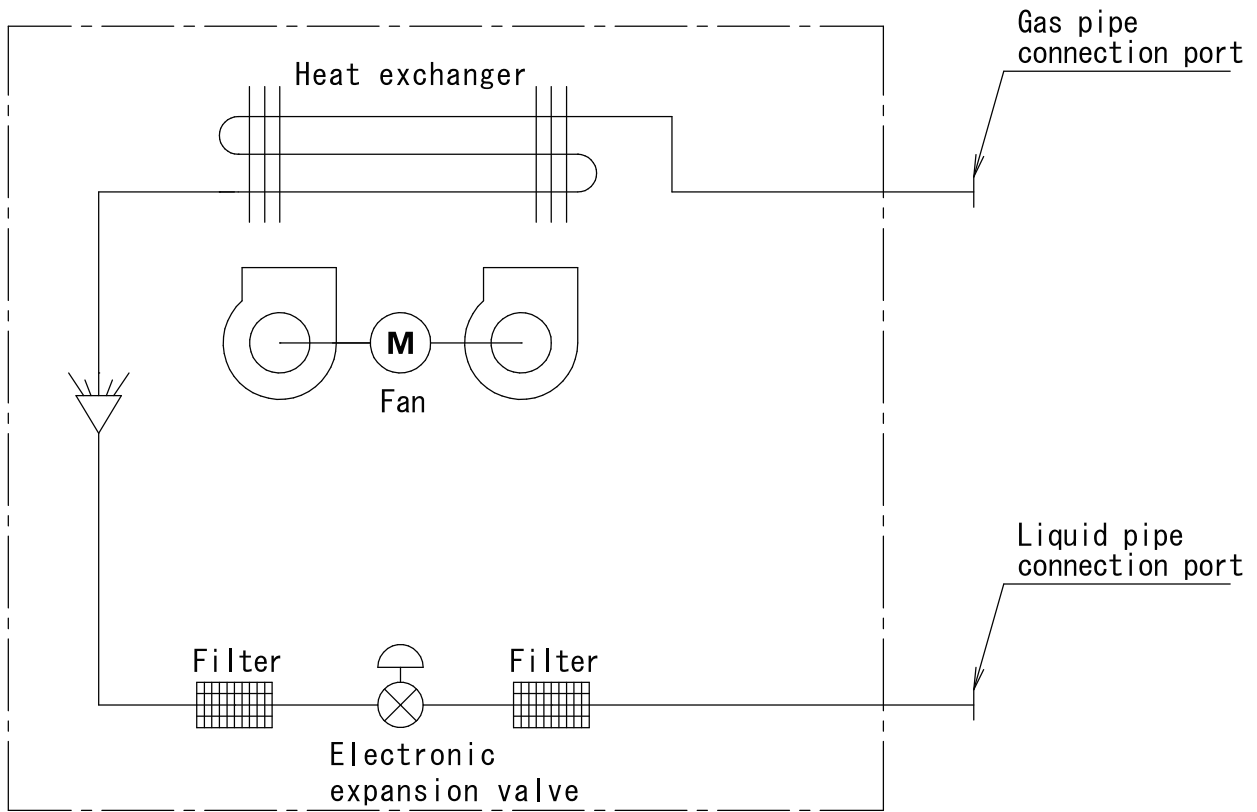

4D141716

Unit: in. (mm)

Model	Gas	Liquid
FXMQ15TBVJU FXMQ18TBVJU	φ1/2 (φ12.7)	φ1/4 (φ6.4)
FXMQ24TBVJU FXMQ30TBVJU FXMQ36TBVJU FXMQ48TBVJU FXMQ54TBVJU	φ5/8 (φ15.9)	φ3/8 (φ9.5)

# 6. Wiring Diagrams

## FXMQ15-54TBVJU

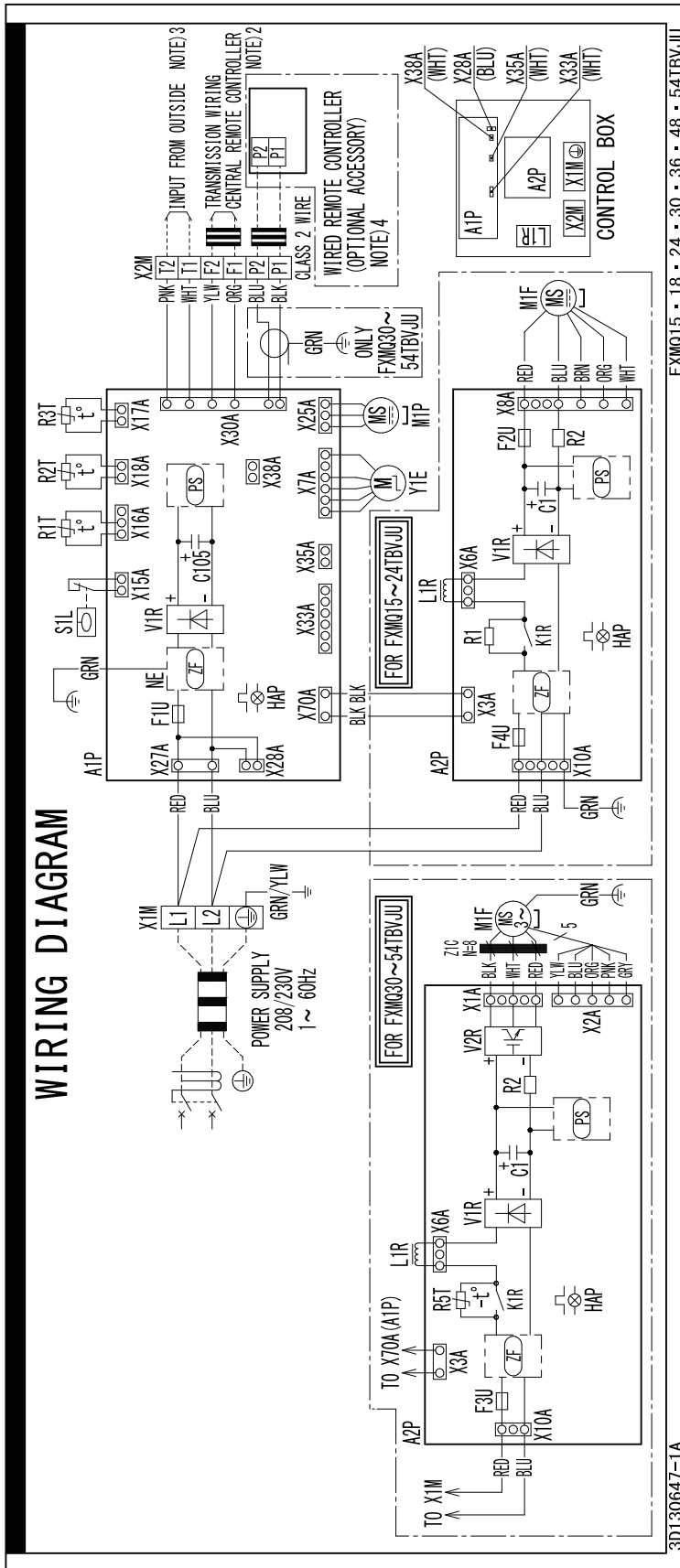

### NOTES

1. [Symbol]: TERMINAL BLOCK, [Symbol]: CONNECTOR, [Symbol]: FIELD WIRING, [Symbol]: PROTECTIVE GROUND (SCREW), [Symbol]: NOISELESS GROUND
2. IN CASE USING CENTRAL REMOTE CONTROLLER, CONNECT IT TO THE UNIT IN ACCORDANCE WITH THE ATTACHED INSTALLATION MANUAL.
3. WHEN CONNECTING INPUT WIRES FROM OUTSIDE, FORCED OFF OR ON/OFF CONTROL OPERATION CAN BE SELECTED BY REMOTE CONTROLLER. IN DETAILS, REFER TO THE INSTALLATION MANUAL ATTACHED TO THE UNIT.
4. IN CASE OF MAIN/SUB CHANGEVER, SEE THE INSTALLATION MANUAL ATTACHED TO REMOTE CONTROLLER.
5. COLORS: RED: RED, BLU: BLUE, BLK: BLACK, WHT: WHITE, YLW: YELLOW, ORG: ORANGE, GRN: GREEN, BRN: BROWN, GRY: GRAY, PNK: PINK.

C: 3D130647B

**FXMQ15-54TBVJU**

INDOOR UNIT	
A1P	PRINTED CIRCUIT BOARD (CONTROL)
A2P	PRINTED CIRCUIT BOARD (FAN)
C1	CAPACITOR
C105	CAPACITOR
F1U	FUSE
F2U	FUSE
F3U	FUSE
F4U	FUSE
HAP	FLASHING LAMP (SERVICE MONITOR-GREEN)
K1R	MAGNETIC RELAY
L1R	REACTOR
M1F	MOTOR (INDOOR FAN)
M1P	MOTOR (DRAIN PUMP)
PS	SWITCHING POWER SUPPLY
R1	RESISTOR (CURRENT LIMITING)
R2	CURRENT SENSING DEVICE
R1T	THERMISTOR (AIR)
R2T-R3T	THERMISTOR (COIL)
R5T	THERMISTOR NTC (CURRENT LIMITING)
S1L	FLOAT SWITCH
V1R	DIODE BRIDGE
V2R	IGBT POWER MODULE
X1M	TERMINAL BLOCK (POWER SUPPLY)
X2M	TERMINAL BLOCK (CONTROL)
Y1E	ELECTRONIC EXPANSION VALVE
Z1C	FERRITE CORE
ZF	NOISE FILTER
CONNECTOR FOR OPTIONAL ACCESSORIES	
X28A	CONNECTOR (POWER SUPPLY FOR WIRING)
X33A	CONNECTOR (ADAPTOR FOR WIRING)
X35A	CONNECTOR (POWER SUPPLY FOR ADAPTOR)
X38A	CONNECTOR (ADAPTOR FOR MULTI TENANT)

C: 3D130647B



## 7. Electric Characteristics

### FXMQ15-54TBVJU

Model	Power supply					IFM		Input (W)		SCCR
	Hz	Volts	Voltage range	MCA	MOP	HP	FLA	Cooling	Heating	
FXMQ15TBVJU	60	208/230 V	Max. 253 V Min. 187 V	1.8	15	0.31 (230)	1.4	204	198	SCCR kA rms, Symmetrical @600V MAX:5
FXMQ18TBVJU				1.9	15	0.31 (230)	1.5	262	256	
FXMQ24TBVJU				1.9	15	0.31 (230)	1.5	257	251	
FXMQ30TBVJU				3.0	15	0.49 (364)	2.4	397	391	
FXMQ36TBVJU				3.1	15	0.49 (364)	2.5	401	395	
FXMQ48TBVJU				3.6	15	0.49 (364)	2.9	464	458	
FXMQ54TBVJU				3.6	15	0.47 (350)	2.9	445	440	

Model	FXMQ15TBVJU		FXMQ18TBVJU		FXMQ24TBVJU		FXMQ30TBVJU		FXMQ36TBVJU		
Operation mode	Cooling	Heating	Cooling	Heating	Cooling	Heating	Cooling	Heating	Cooling	Heating	
Input power (W)	H	204	198	262	256	257	251	397	391	401	395
	M	137	133	211	207	198	194	248	246	293	290
	L	116	113	178	175	167	163	224	222	214	212

Model	FXMQ48TBVJU		FXMQ54TBVJU		
Operation mode	Cooling	Heating	Cooling	Heating	
Input power (W)	H	464	458	445	440
	M	331	327	306	303
	L	237	234	206	204

#### Symbol:

MCA: Minimum Circuit Ampacity (A)  
MOP: Maximum Overcurrent Protective Device (A)  
HP: Fan Motor Rated Output (Hp (W))  
FLA: Full Load Ampere (A)  
IFM: Indoor Fan Motor  
SCCR: Short-Circuit Current Rating

#### Note:

- Voltage range  
Units are suitable for use on electrical systems where voltage supplied to unit terminals is not below or above listed range limits.
- Maximum allowable voltage unbalance between phases is 2%.
- MCA/MOP  
 $MCA = 1.25 \times FLA$   
 $MOP \leq 4 \times FLA$   
(Next lower standard fuse rating, Min. 15 A)
- Select wire size based on the MCA.
- Instead of fuse, use circuit breaker.
- Cooling power input value includes power required to operate the built-in drain pump.

C: 4D140802

## 8. Safety Devices Setting

Model	FXMQ15TBVJU	FXMQ18TBVJU	FXMQ24TBVJU	FXMQ30TBVJU
Printed circuit board fuse	250 V, 3.15 A	250 V, 3.15 A	250 V, 3.15 A	250 V, 3.15 A
Printed circuit board fuse (fan driver)	250 V, 6.3 A	250 V, 6.3 A	250 V, 6.3 A	250 V, 6.3 A
Drain pump thermal fuse	°F (°C)	—	—	—

Model	FXMQ36TBVJU	FXMQ48TBVJU	FXMQ54TBVJU
Printed circuit board fuse	250 V, 3.15 A	250 V, 3.15 A	250 V, 3.15 A
Printed circuit board fuse (fan driver)	250 V, 6.3 A	250 V, 6.3 A	250 V, 6.3 A
Drain pump thermal fuse	°F (°C)	—	—

C: 3D140811

## 9. Capacity Tables

### 9.1 Cooling Capacity at Te: 43°F (6°C)

Model	Indoor air temp. °FWB (°CWB) (Te: 43°F (6°C))											
	61 (16.1)		64 (17.8)		67 (19.4)		70 (21.1)		72 (22.2)		75 (23.9)	
	TC	SHC	TC	SHC	TC	SHC	TC	SHC	TC	SHC	TC	SHC
	MBH	MBH	MBH	MBH	MBH	MBH	MBH	MBH	MBH	MBH	MBH	MBH
FXMQ15TBVJU	11.4	9.3	12.9	10.2	14.2	10.4	14.5	10.1	14.6	10.0	14.8	9.5
FXMQ18TBVJU	14.5	12.3	16.3	13.5	18.0	13.8	18.4	13.5	18.7	13.3	18.8	13.0
FXMQ24TBVJU	19.3	15.0	21.9	16.6	24.0	16.8	24.4	16.4	24.7	16.1	25.1	15.6
FXMQ30TBVJU	24.2	20.0	27.6	22.2	30.0	22.4	30.6	21.8	31.0	21.4	31.6	20.8
FXMQ36TBVJU	29.1	22.9	33.0	25.2	36.0	25.7	36.7	25.1	37.2	24.7	37.9	23.9
FXMQ48TBVJU	38.8	30.7	44.1	33.9	48.0	34.8	49.0	33.9	49.7	33.4	50.5	32.2
FXMQ54TBVJU	46.1	36.9	52.5	40.9	57.0	41.8	58.2	40.8	59.1	40.2	59.9	38.6

TC: Total capacity: MBH  
SHC: Sensible heat capacity: MBH

**Note:**

- These capacity tables can be used when selecting a **VRV** indoor unit. The actual capacity of the **VRV** system depends on factors such as the selected model of outdoor units, outdoor air temperature and piping length. Please confirm that the corrected capacity of the **VRV** system satisfies the required heat load.
- ☐ shows rated condition.

CA22A1253

### 9.2 Heating Capacity at Tc: 115°F (46°C)

Model	Indoor air temp. °FDB (°CDB) (Tc: 115°F (46°C))											
	62 (16.7)		65 (18.3)		68 (20.0)		70 (21.1)		72 (22.2)		75 (23.9)	
	TC	TC	TC	TC	TC	TC	TC	TC	TC	TC	TC	
	MBH	MBH	MBH	MBH	MBH	MBH	MBH	MBH	MBH	MBH	MBH	
FXMQ15TBVJU	18.5	18.3	17.6	17.0	16.4	15.4						
FXMQ18TBVJU	21.9	21.7	20.8	20.0	19.4	18.3						
FXMQ24TBVJU	29.3	29.1	27.9	27.0	26.0	24.4						
FXMQ30TBVJU	36.9	36.7	35.3	34.0	32.7	30.9						
FXMQ36TBVJU	43.5	43.2	41.4	40.0	38.5	36.2						
FXMQ48TBVJU	58.9	58.4	56.1	54.0	52.0	49.1						
FXMQ54TBVJU	68.9	68.3	65.6	63.0	60.5	57.6						

TC: Total capacity: MBH

**Note:**

- These capacity tables can be used when selecting a **VRV** indoor unit. The actual capacity of the **VRV** system depends on factors such as the selected model of outdoor units, outdoor air temperature and piping length. Please confirm that the corrected capacity of the **VRV** system satisfies the required heat load.
- ☐ shows rated condition.

CA22A1253

### 9.3 Correction Factor for Cooling Capacity at Te: 48°F (9°C)

Refer to the correction factor table below when a mini-split indoor unit is connected to a **VRV** Heat Pump system using a Branch Port box.

Model	Indoor air temp. °FWB (°CWB) (Te: 48°F (9°C))											
	61 (16.1)		64 (17.8)		67 (19.4)		70 (21.1)		72 (22.2)		75 (23.9)	
	TC	SHF	TC	SHF	TC	SHF	TC	SHF	TC	SHF	TC	SHF
FXMQ15TBVJU	0.65	1.17	0.69	1.14	0.75	1.06	0.78	1.05	0.79	1.04	0.81	1.02
FXMQ18TBVJU	0.71	1.17	0.75	1.16	0.82	1.09	0.84	1.07	0.85	1.06	0.87	1.05
FXMQ24TBVJU	0.65	1.16	0.70	1.12	0.75	1.06	0.78	1.04	0.79	1.04	0.80	1.03
FXMQ30TBVJU	0.68	1.17	0.73	1.13	0.79	1.07	0.81	1.05	0.82	1.05	0.84	1.03
FXMQ36TBVJU	0.69	1.17	0.74	1.14	0.80	1.07	0.83	1.06	0.84	1.05	0.85	1.04
FXMQ48TBVJU	0.73	1.17	0.77	1.13	0.83	1.07	0.86	1.06	0.87	1.06	0.89	1.05
FXMQ54TBVJU	0.75	1.17	0.80	1.14	0.86	1.08	0.89	1.06	0.90	1.06	0.91	1.05

TC: Total capacity  
 SHF: Sensible heat factor

CA22A1253

# 10. Fan Performance

## FXMQ15TBVJU

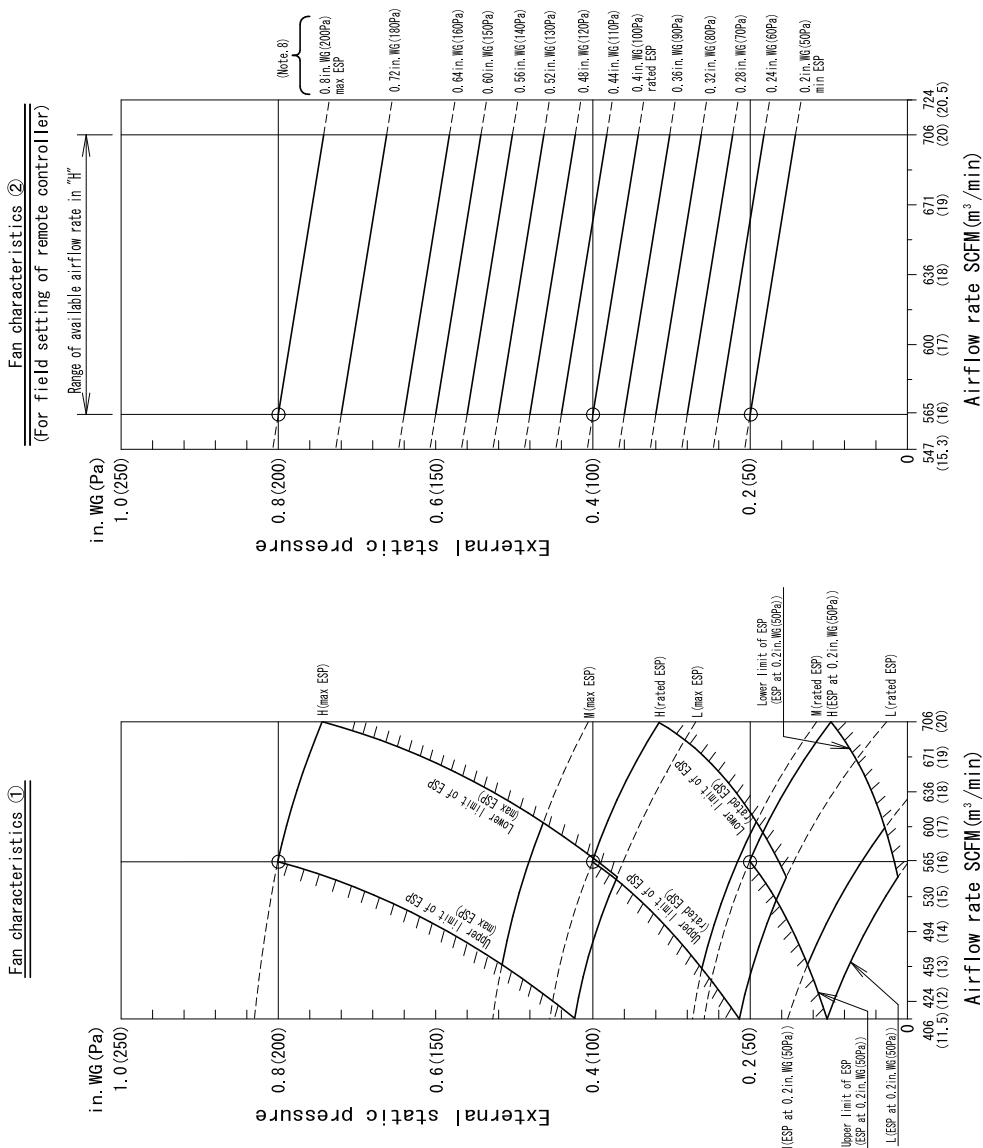

**Notes:**

1. Fan characteristics at the time of rear suction and bottom suction are similar.
2. Fan characteristics ① shows a representative of fan characteristics at the time of "Maximum ESP", "Rated ESP" and "ESP at 0.2 in. WG (50Pa)".
3. A remote controller can be used to change airflow rate of "H", "M" and "L".
4. Set ESP on suction side to 0.4 in. WG (100Pa) or less.
5. Fan characteristics ② (for field setting of remote controller) shows fan characteristics of airflow rate "H" which can be changed in the field setting by a remote controller.
6. Select ESP setting in accordance with resistance of the connected duct by referring to Fan characteristics ① and ②. (Factory setting of ESP is 0.2 in. WG (100Pa).)
7. See installation manual for ESP setting procedure.)
8. The ESP setting of this unit can be changed into 14 levels. The value of fan characteristics ② mentioned in this drawing shows ESP at the rated airflow rate.

FXMQ18TBVJU

Fan characteristics ②  
(For field setting of remote controller)

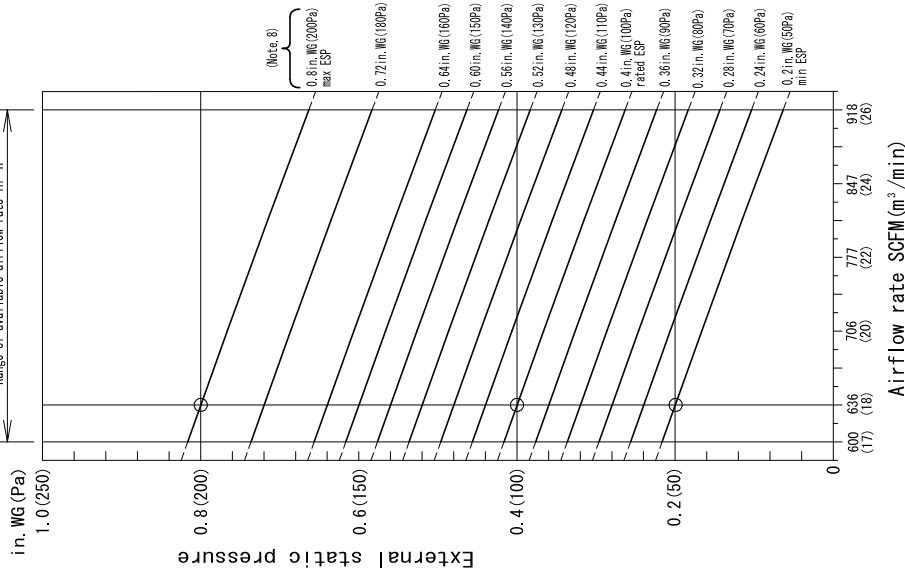

Fan characteristics ①

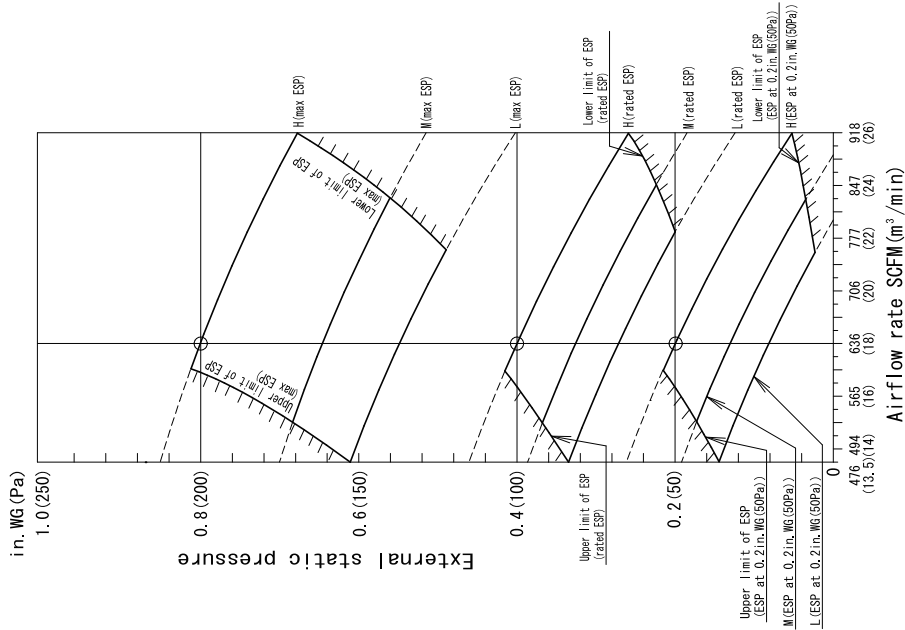

Notes:

1. Fan characteristics at the time of rear suction and bottom suction are similar.
2. Fan characteristics ① shows a representative of fan characteristics at the time of "Maximum ESP", "Rated ESP" and "ESP at 0.2 in. WG (50Pa)".
3. A remote controller can be used to change airflow rate of "H", "M" and "L".
4. Set ESP on suction side to 0.4 in. WG (100Pa) or less.
5. Fan characteristics ② (for field setting of remote controller) shows fan characteristics of airflow rate "H" which can be changed in the field setting by a remote controller.
6. Select ESP setting in accordance with resistance of the connected duct by referring to Fan characteristics ① and ②. (Factory setting of ESP is 0.2 in. WG (100Pa). See installation manual for ESP setting procedure.)
7. The ESP setting of this unit can be changed into 14 levels.
8. The value of fan characteristics ② mentioned in this drawing shows ESP at the rated airflow rate.

FXMQ24TBVJU

**Fan characteristics ②**  
(For field setting of remote controller)

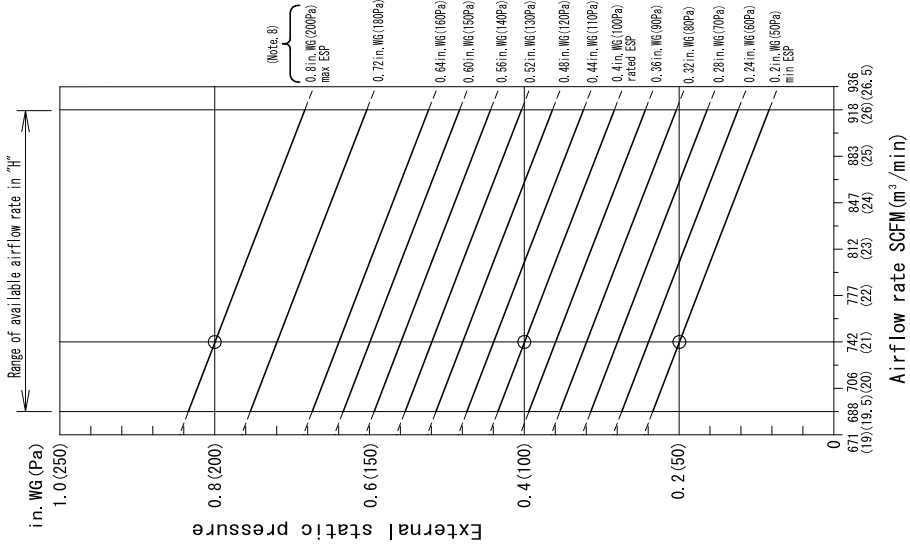

**Fan characteristics ①**

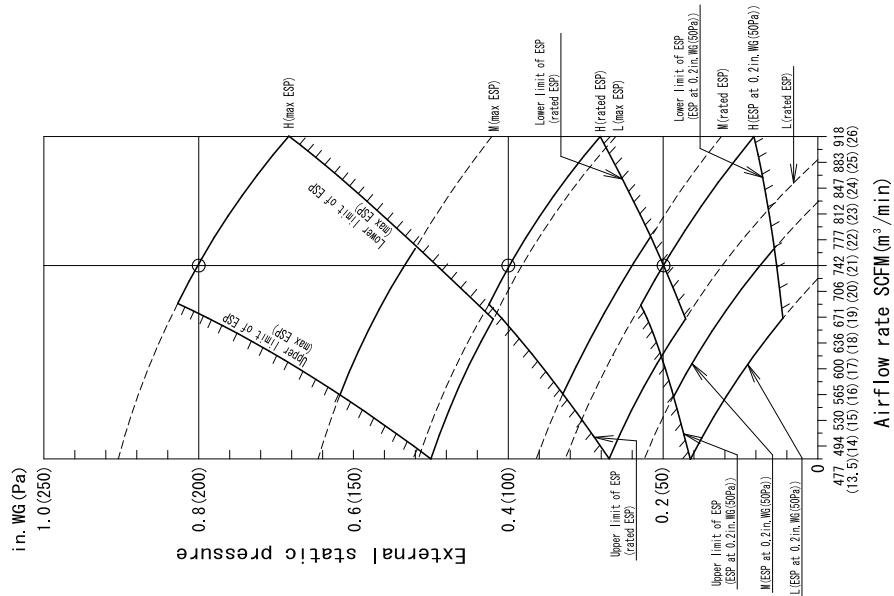

- Notes:
1. Fan characteristics at the time of rear suction and bottom suction are similar.
  2. Fan characteristics ① shows a representative of fan characteristics at the time of "Maximum ESP", "Rated ESP" and "ESP at 0.2 in. WG (50Pa)".
  3. A remote controller can be used to change airflow rate of "H", "M" and "L".
  4. Set ESP on suction side to 0.4 in. WG (100Pa) or less.
  5. Fan characteristics ② (for field setting of remote controller) shows fan characteristics of airflow rate "H" which can be changed in the field setting by a remote controller.
  6. Select ESP setting in accordance with resistance of the connected duct by referring to Fan characteristics ① and ②. (Factory setting of ESP is 0.2 in. WG (100Pa). See installation manual for ESP setting procedure.)
  7. The ESP setting of this unit can be changed into 14 levels.
  8. The value of fan characteristics ② mentioned in this drawing shows ESP at the rated airflow rate.

FXMQ30TBVJU

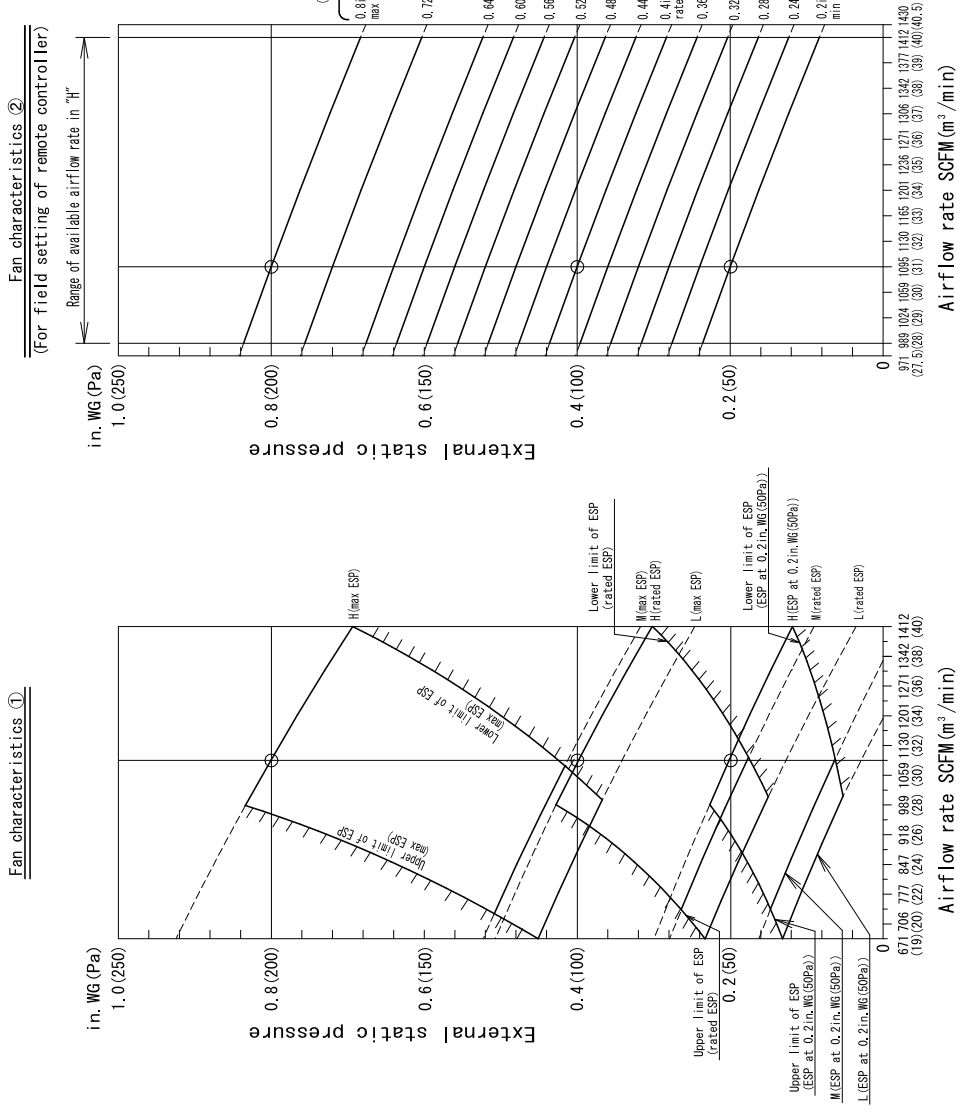

3D143368



FXMQ36TBVJU

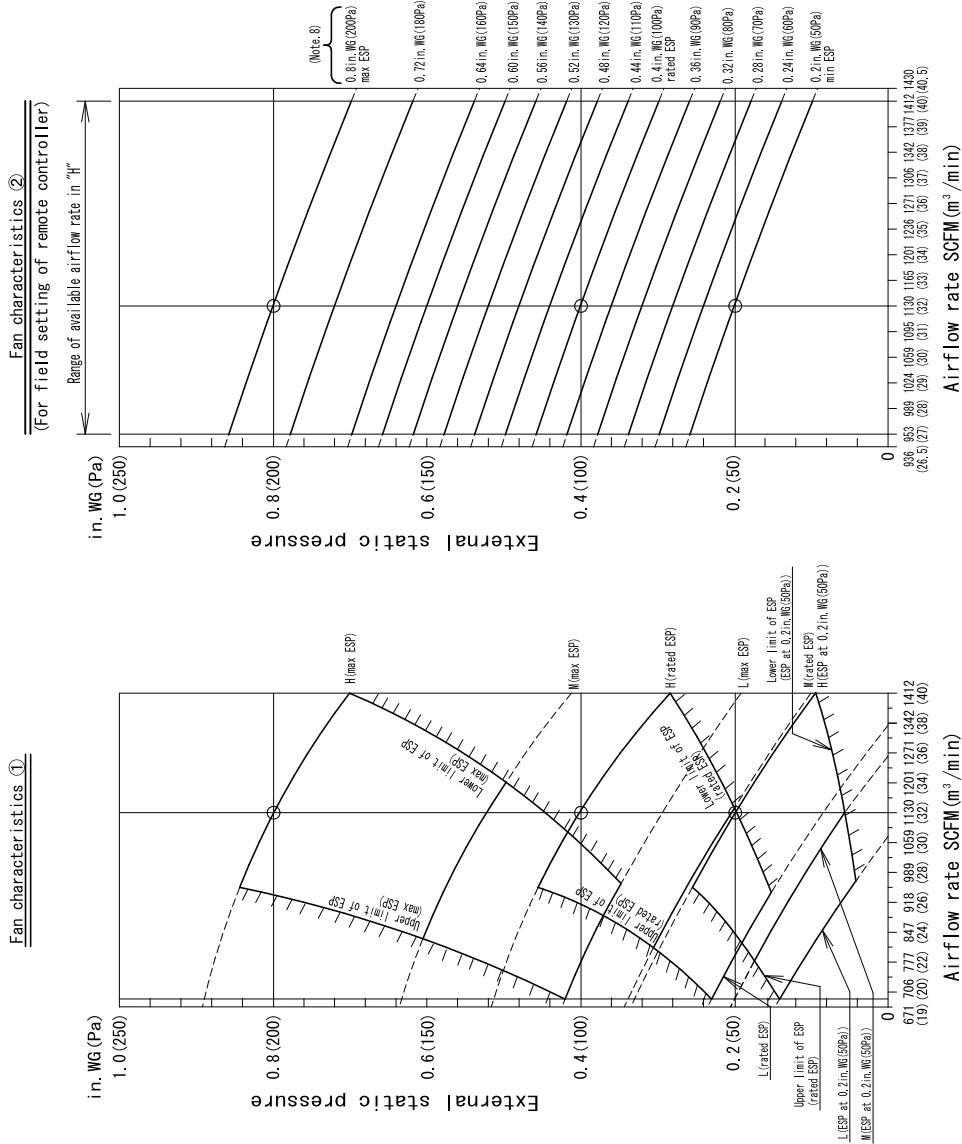

- Notes:
1. Fan characteristics at the time of rear suction and bottom suction are similar.
  2. Fan characteristics ① shows a representative of fan characteristics at the time of "Maximum ESP", "Rated ESP" and "ESP at 0.2 in. WG (50Pa)", "H", "M" and "L".
  3. A remote controller can be used to change airflow rate of "H", "M" and "L".
  4. Set ESP on suction side to 0.4 in. WG (100Pa) or less.
  5. Fan characteristics ② (for field setting of remote controller) shows fan characteristics of airflow rate "H" which can be changed in the field setting by a remote controller.
  6. Select ESP setting in accordance with resistance of the connected duct by referring to Fan characteristics ① and ②. (Factory setting of ESP is 0.2 in. WG (100Pa). See installation manual for ESP setting procedure.)
  7. The ESP setting of this unit can be changed into 14 levels.
  8. The value of fan characteristics ② mentioned in this drawing shows ESP at the rated airflow rate.

FXMQ48TBVJU

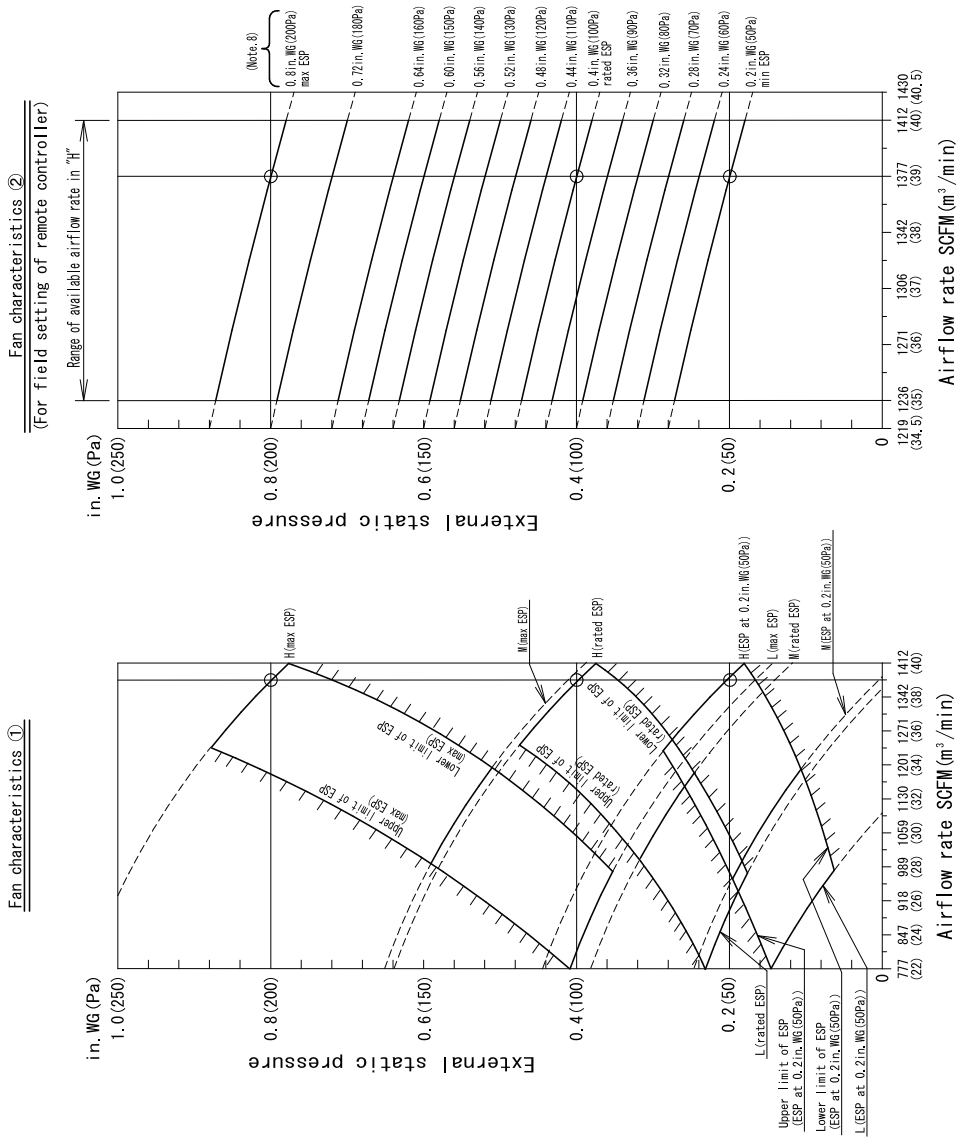

- Notes:
1. Fan characteristics at the time of rear suction and bottom suction are similar.
  2. Fan characteristics ① shows a representative of fan characteristics at the time of "Maximum ESP", "Rated ESP" and "ESP at 0.2 in. WG (50Pa)".
  3. A remote controller can be used to change airflow rate of "H", "M" and "L".
  4. Set ESP on suction side to 0.4 in. WG (100Pa) or less.
  5. Fan characteristics ② (for field setting of remote controller) shows fan characteristics of airflow rate "H" which can be changed in the field setting by a remote controller.
  6. Select ESP setting in accordance with resistance of the connected duct by referring to Fan characteristics ① and ②. (Factory setting of ESP is 0.2 in. WG (100Pa). See installation manual for ESP setting procedure.)
  7. The ESP setting of this unit can be changed into 14 levels.
  8. The value of fan characteristics ② mentioned in this drawing shows ESP at the rated airflow rate.

3D143370

# FXMQ54TBVJU

**Fan characteristics ①**

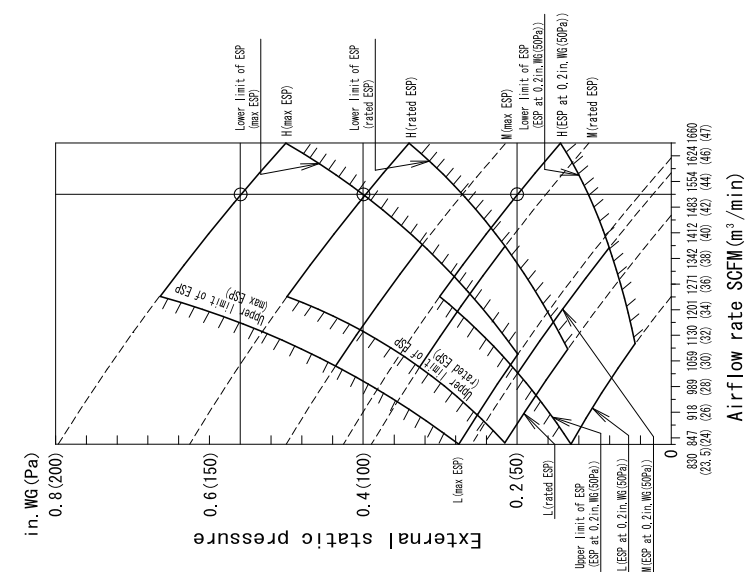

**Fan characteristics ②**  
(For field setting of remote controller)

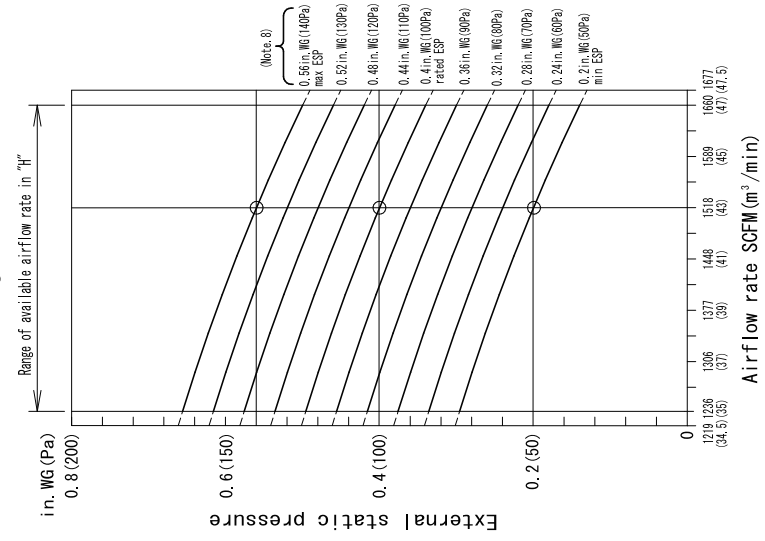

- Notes:
1. Fan characteristics at the time of rear suction and bottom suction are similar.
  2. Fan characteristics ① shows a representative of fan characteristics at the time of "Maximum ESP", "Rated ESP" and "ESP at 0.2 in. WG (50Pa)".
  3. A remote controller can be used to change airflow rate of "H", "M" and "L".
  4. Set ESP on suction side to 0.4 in. WG (100Pa) or less.
  5. Fan characteristics ② (for field setting of remote controller) shows fan characteristics of airflow rate "H" which can be changed in the field setting by a remote controller.
  6. Select ESP setting in accordance with resistance of the connected duct by referring to Fan characteristics ① and ②. (Factory setting of ESP is 0.2 in. WG (100Pa). See installation manual for ESP setting procedure.)
  7. The ESP setting of this unit can be changed into 10 levels.
  8. The value of fan characteristics ② mentioned in this drawing shows ESP at the rated airflow rate.

# 11. Airflow Auto Adjustment Characteristics

## FXMQ15TBVJU

**Notes:**

1. This indoor unit has the "Airflow automatic adjustment" function, which automatically adjusts the airflow rate so as to be approximately in the range of  $\pm 10\%$  of the rated value at the time of installation.
2. After duct construction completion, perform field setting "Airflow automatic adjustment" by remote controller.
3. About the field setting method of the "Airflow automatic adjustment", refer to the installation manual attached to indoor unit.
4. External static pressure that can be adjusted by "Airflow automatic adjustment" function is 0.2in. WG - 0.8in. WG (50Pa - 200Pa) (When airflow rate is "H").
5. If the unit is used beyond the range of the above external static pressure, the airflow rate can not be well-adjusted automatically, and the unit will operate with the airflow rate different from the rated value.
6. This figure shows fan characteristics at the time of "H", "M" and "L".
7. The remote controller can be used to change airflow rate of "H", "M" and "L".
8. ESP: External static pressure

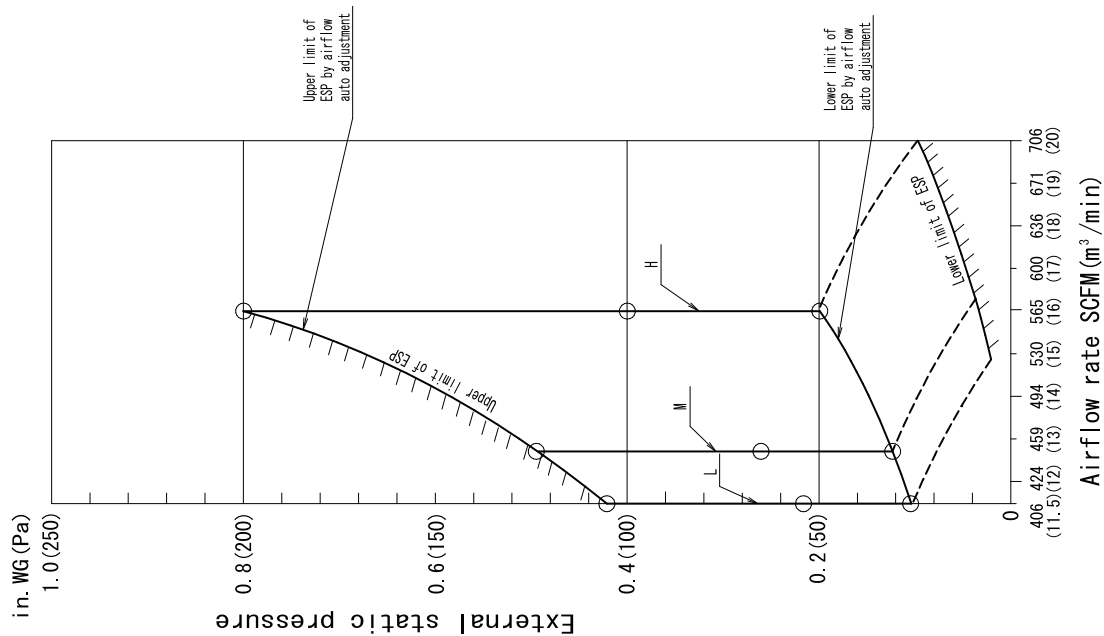

FXMQ18TBVJU

Notes:

1. This indoor unit has the "Airflow automatic adjustment" function, which automatically adjusts the airflow rate so as to be approximately in the range of  $\pm 10\%$  of the rated value at the time of installation.
2. After duct construction completion, perform field setting "Airflow automatic adjustment" by remote controller.
3. About the field setting method of the "Airflow automatic adjustment", refer to the installation manual attached to indoor unit.
4. External static pressure that can be adjusted by "Airflow automatic adjustment" function is 0.2in.WG - 0.8in.WG (50Pa - 200Pa) (When airflow rate is "H").
5. If the unit is used beyond the range of the above external static pressure, the airflow rate can not be well-adjusted automatically, and the unit will operate with the airflow rate different from the rated value.
6. This figure shows fan characteristics at the time of "H", "M" and "L".
7. The remote controller can be used to change airflow rate of "H", "M" and "L".
8. ESP: External static pressure

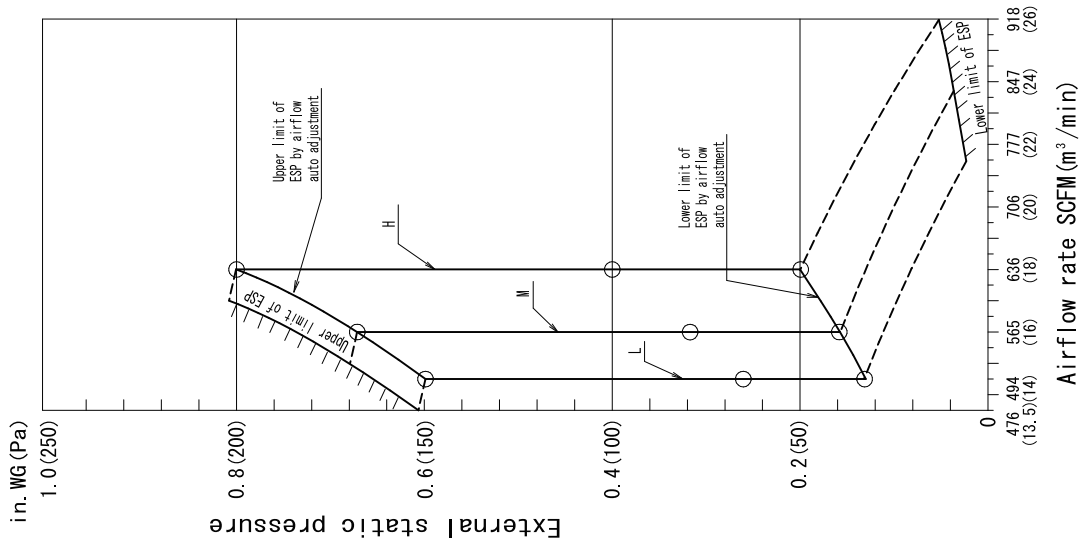

FXMQ24TBVJU

Notes:

1. This indoor unit has the "Airflow automatic adjustment" function, which automatically adjusts the airflow rate so as to be approximately in the range of  $\pm 10\%$  of the rated value at the time of installation.
2. After duct construction completion, perform field setting "Airflow automatic adjustment" by remote controller.
3. About the field setting method of the "Airflow automatic adjustment", refer to the installation manual attached to indoor unit.
4. External static pressure that can be adjusted by "Airflow automatic adjustment" function is 0.2in.WG - 0.8in.WG (50Pa - 200Pa) (When airflow rate is "H").
5. If the unit is used beyond the range of the above external static pressure, the airflow rate can not be well-adjusted automatically, and the unit will operate with the airflow rate different from the rated value.
6. This figure shows fan characteristics at the time of "H", "M" and "L".
7. The remote controller can be used to change airflow rate of "H", "M" and "L".
8. ESP: External static pressure

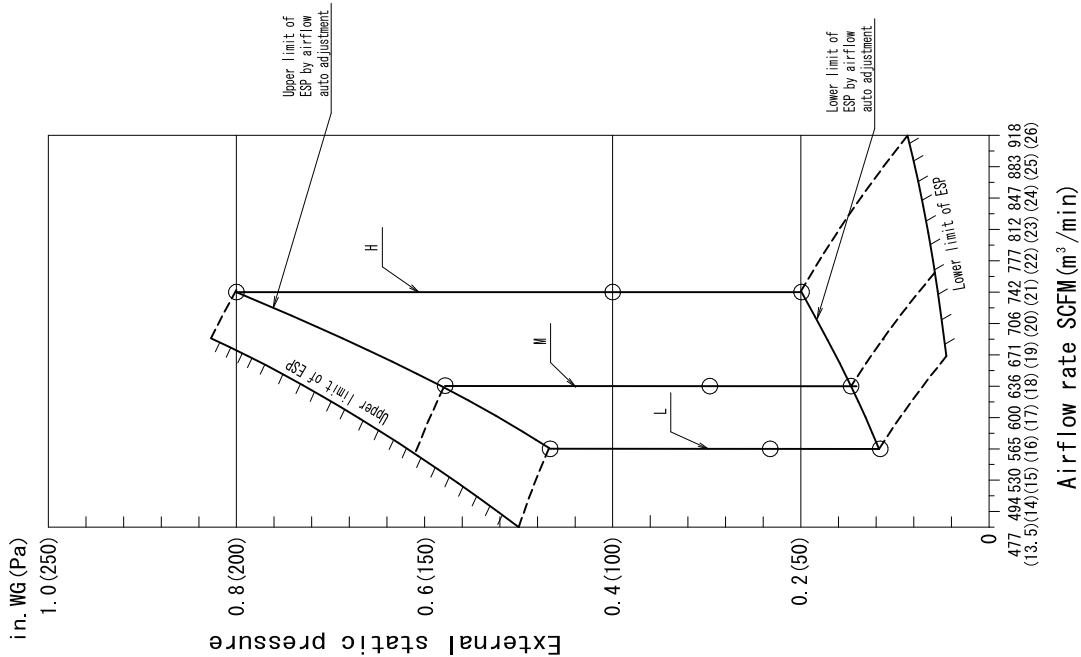

FXMQ30TBVJU

Notes:

1. This indoor unit has the "Airflow automatic adjustment" function, which automatically adjusts the airflow rate so as to be approximately in the range of  $\pm 10\%$  of the rated value at the time of installation.
2. After duct construction completion, perform field setting "Airflow automatic adjustment" by remote controller.
3. About the field setting method of the "Airflow automatic adjustment", refer to the installation manual attached to indoor unit.
4. External static pressure that can be adjusted by "Airflow automatic adjustment" function is 0.2in.WG - 0.8in.WG (50Pa - 200Pa) (When airflow rate is "H").
5. If the unit is used beyond the range of the above external static pressure, the airflow rate can not be well-adjusted automatically, and the unit will operate with the airflow rate different from the rated value.
6. This figure shows fan characteristics at the time of "H", "M" and "L".
7. The remote controller can be used to change airflow rate of "H", "M" and "L".
8. ESP: External static pressure

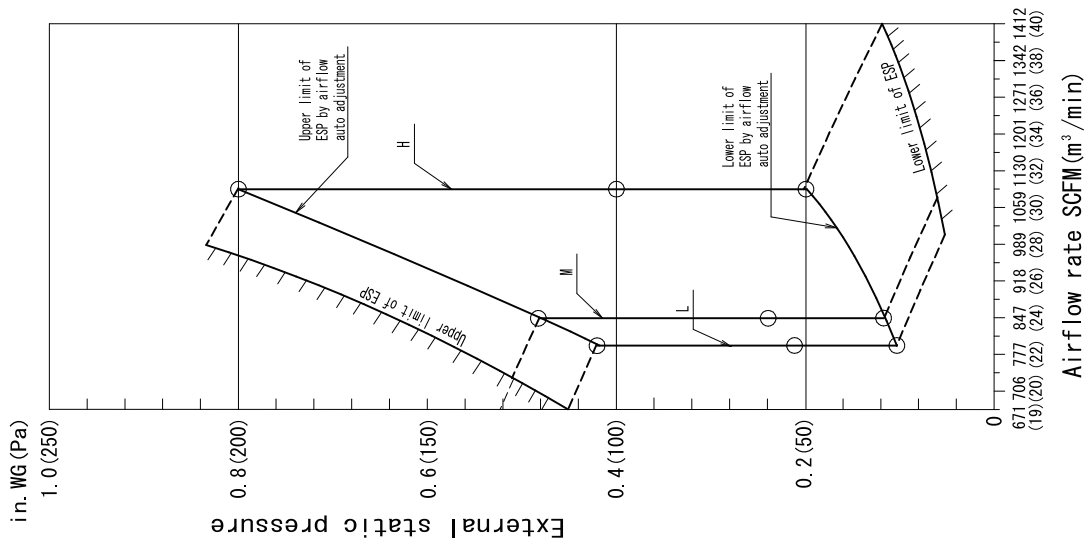

FXMQ36TBVJU

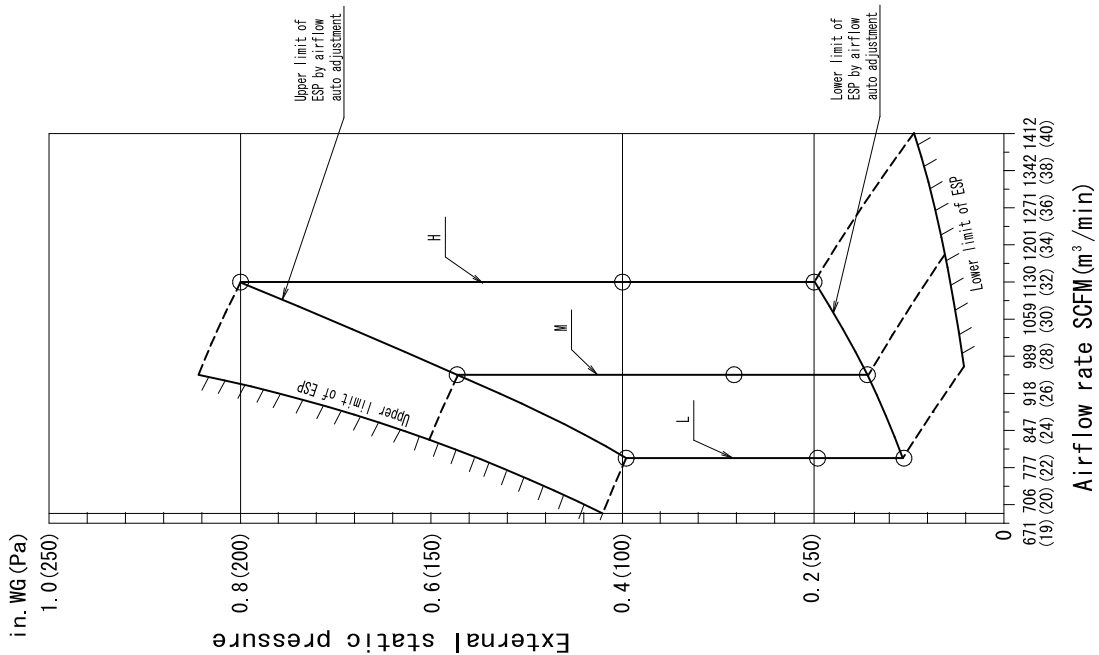

Notes:

1. This indoor unit has the "Airflow automatic adjustment" function, which automatically adjusts the airflow rate so as to be approximately in the range of ±10% of the rated value at the time of installation.
2. After duct construction completion, perform field setting "Airflow automatic adjustment" by remote controller.
3. About the field setting method of the "Airflow automatic adjustment", refer to the installation manual attached to indoor unit.
4. External static pressure that can be adjusted by "Airflow automatic adjustment" function is 0.2in.WG - 0.8in.WG (50Pa - 200Pa) (When airflow rate is "H").
5. If the unit is used beyond the range of the above external static pressure, the airflow rate can not be well-adjusted automatically, and the unit will operate with the airflow rate different from the rated value.
6. This figure shows fan characteristics at the time of "H", "M" and "L".
7. The remote controller can be used to change airflow rate of "H", "M" and "L".
8. ESP: External static pressure



FXMQ48TBVJU

Notes:

1. This indoor unit has the "Airflow automatic adjustment" function, which automatically adjusts the airflow rate so as to be approximately in the range of  $\pm 10\%$  of the rated value at the time of installation.
2. After duct construction completion, perform field setting "Airflow automatic adjustment" by remote controller.
3. About the field setting method of the "Airflow automatic adjustment", refer to the installation manual attached to indoor unit.
4. External static pressure that can be adjusted by "Airflow automatic adjustment" function is 0.2in.WG - 0.8in.WG (50Pa - 200Pa) (When airflow rate is "H").
5. If the unit is used beyond the range of the above external static pressure, the airflow rate can not be well-adjusted automatically, and the unit will operate with the airflow rate different from the rated value.
6. This figure shows fan characteristics at the time of "H", "M" and "L".
7. The remote controller can be used to change airflow rate of "H", "M" and "L".
8. ESP: External static pressure

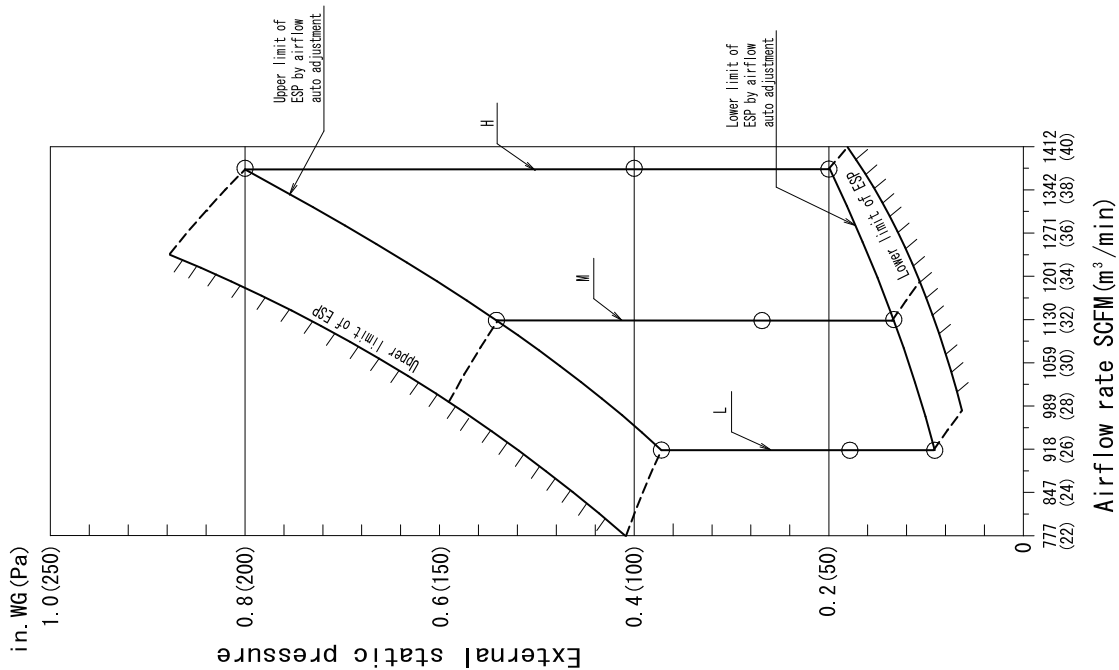

FXMQ54TBVJU

Notes:

1. This indoor unit has the "Airflow automatic adjustment" function, which automatically adjusts the airflow rate so as to be approximately in the range of  $\pm 10\%$  of the rated value at the time of installation.
2. After duct construction completion, perform field setting "Airflow automatic adjustment" by remote controller.
3. About the field setting method of the "Airflow automatic adjustment", refer to the installation manual attached to indoor unit.
4. External static pressure that can be adjusted by "Airflow automatic adjustment" function is 0.2in.WG - 0.56in.WG (50Pa - 140Pa) (When airflow rate is "H").
5. If the unit is used beyond the range of the above external static pressure, the airflow rate can not be well-adjusted automatically, and the unit will operate with the airflow rate different from the rated value.
6. This figure shows fan characteristics at the time of "H", "M" and "L".
7. The remote controller can be used to change airflow rate of "H", "M" and "L".
8. ESP: External static pressure

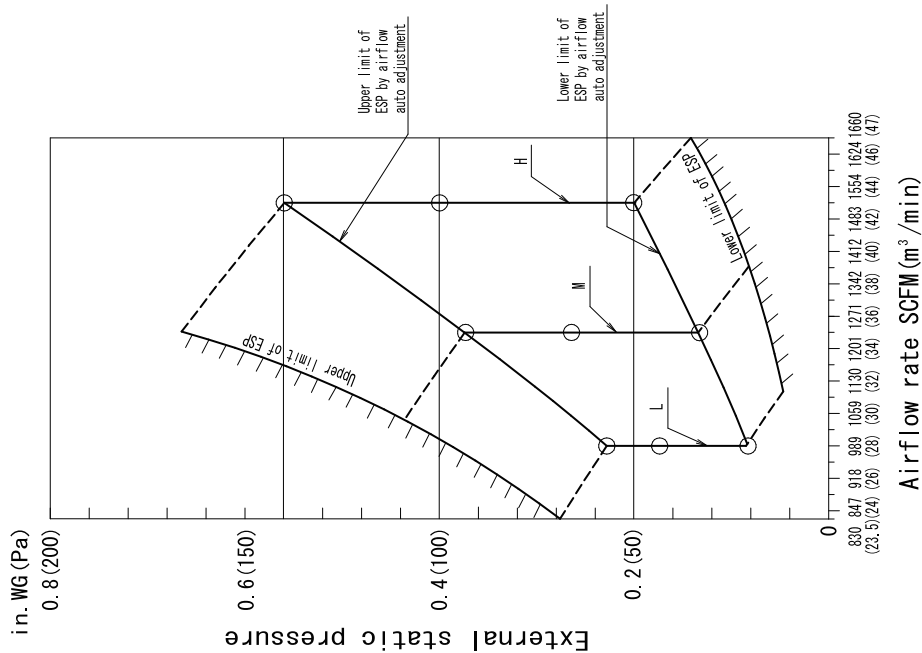

# 12.Sound Levels (Reference Data)

## FXMQ15TBVJU

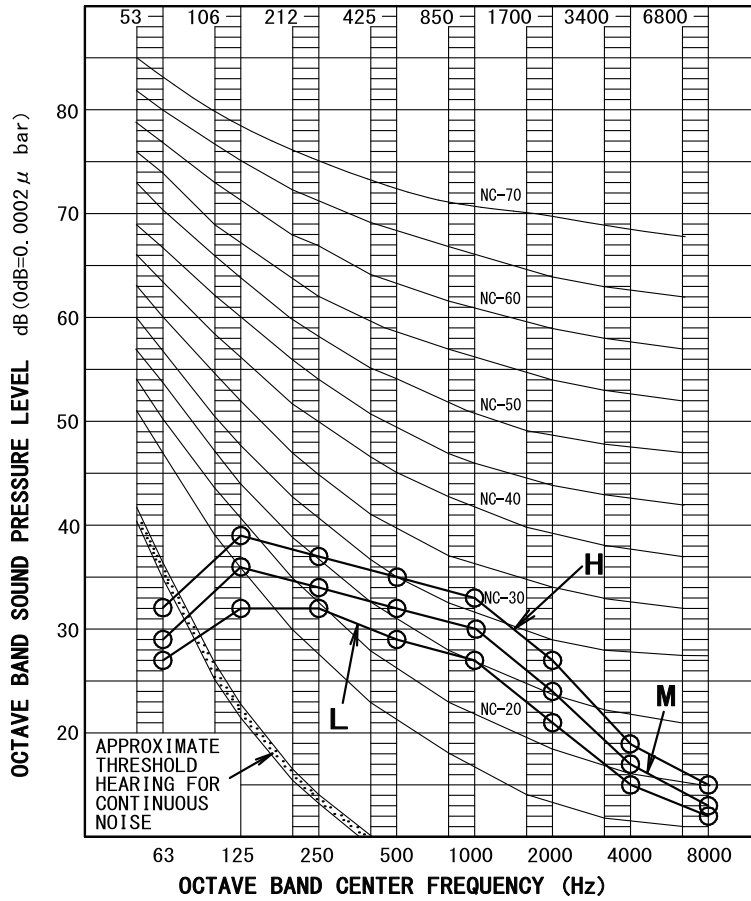

OVER ALL ( dB )

OPERATING CONDITIONS

SCALE	AIRFLOW RATE		
	H	M	L
A	37.0	34.0	31.0

( B. G. N IS ALREADY RECTIFIED )

**MEASURING PLACE**

ANECHOIC CHAMBER

POWER SOURCE	208 / 230V 60Hz
<b>COOLING</b>	
RETURN AIR TEMPERATURE:	80.0° F (26.7°C) DB, 67.0° F (19.4°C) WB
OUTDOOR TEMPERATURE :	95.0° F (35.0°C) DB, 75.0° F (23.9°C) WB
<b>HEATING</b>	
RETURN AIR TEMPERATURE:	70.0° F (21.1°C) DB, 60.0° F (15.6°C) WB
OUTDOOR TEMPERATURE :	47.0° F ( 8.3°C) DB, 43.0° F ( 6.1°C) WB
EXTERNAL STATIC PRESSURE	0.4 in. WG (100Pa)

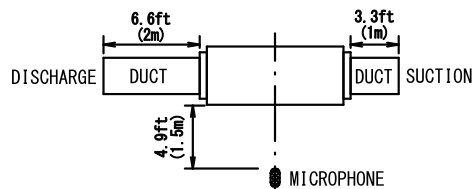

NOTE: OPERATION NOISE DIFFERS WITH OPERATION AND AMBIENT CONDITIONS.

FXMQ18TBVJU

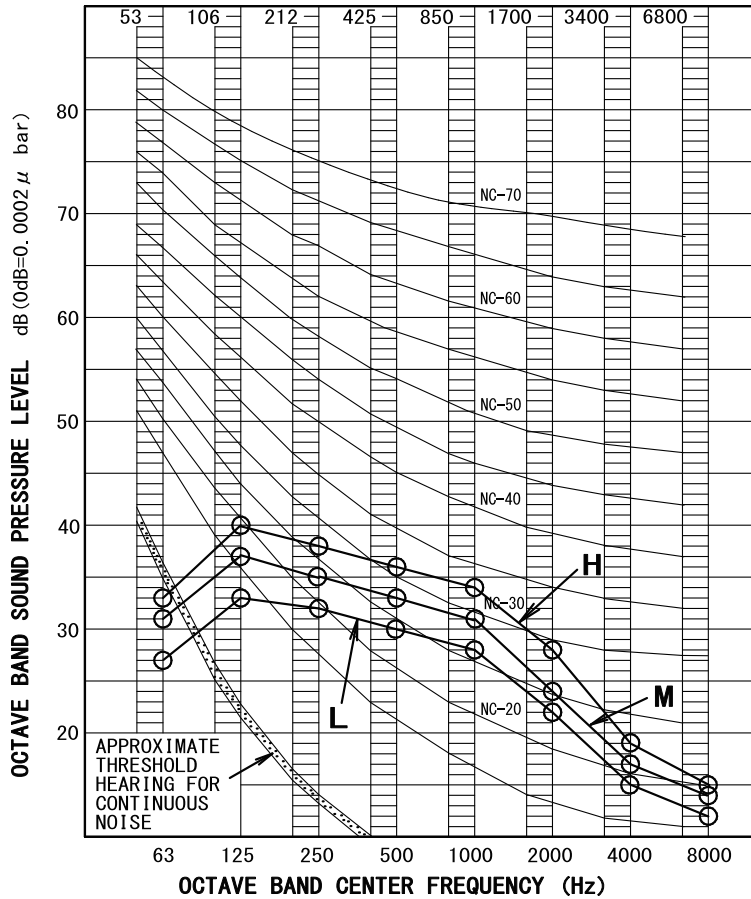

OVER ALL ( dB )

OPERATING CONDITIONS

SCALE	AIRFLOW RATE		
	H	M	L
A	38.0	35.0	32.0

( B. G. N IS ALREADY RECTIFIED )

MEASURING PLACE

ANECHOIC CHAMBER

POWER SOURCE 208 / 230V 60Hz

COOLING

RETURN AIR TEMPERATURE: 80.0° F (26.7°C) DB, 67.0° F (19.4°C) WB  
 OUTDOOR TEMPERATURE : 95.0° F (35.0°C) DB, 75.0° F (23.9°C) WB

HEATING

RETURN AIR TEMPERATURE: 70.0° F (21.1°C) DB, 60.0° F (15.6°C) WB  
 OUTDOOR TEMPERATURE : 47.0° F ( 8.3°C) DB, 43.0° F ( 6.1°C) WB

EXTERNAL STATIC PRESSURE 0.4 in. WG (100Pa)

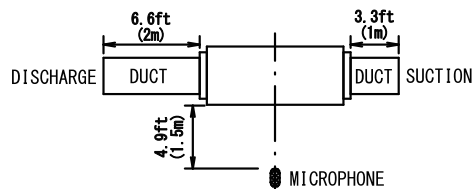

NOTE: OPERATION NOISE DIFFERS WITH OPERATION AND AMBIENT CONDITIONS.

FXMQ24TBVJU

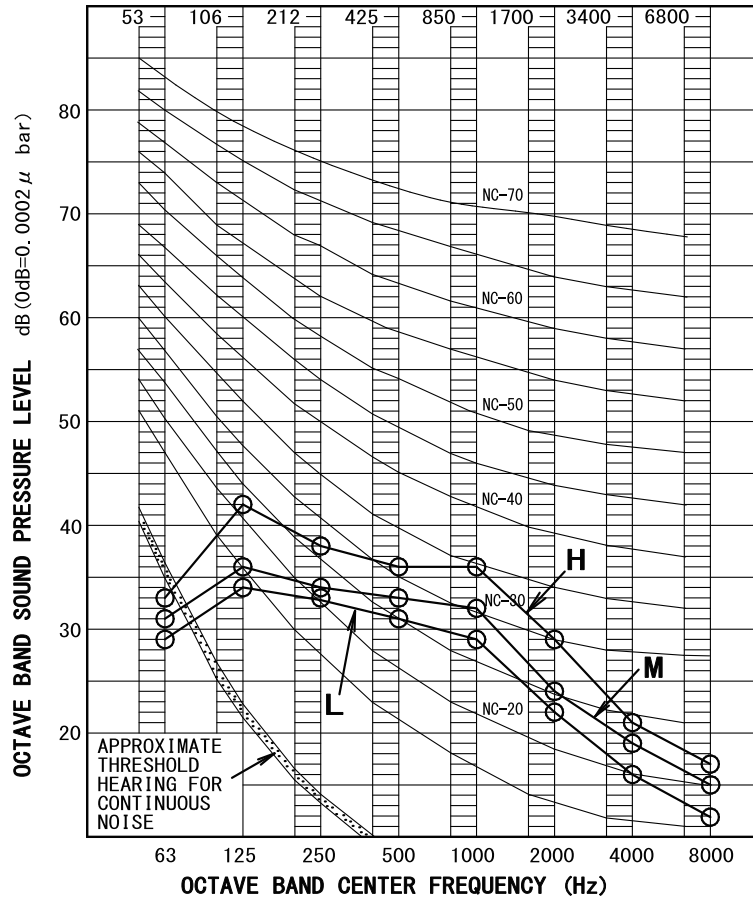

OVER ALL ( dB )

OPERATING CONDITIONS

SCALE	AIRFLOW RATE		
	H	M	L
A	39.0	35.0	33.0

( B. G. N IS ALREADY RECTIFIED )

MEASURING PLACE

ANECHOIC CHAMBER

POWER SOURCE 208 / 230V 60Hz

COOLING

RETURN AIR TEMPERATURE: 80.0° F (26.7°C) DB, 67.0° F (19.4°C) WB  
 OUTDOOR TEMPERATURE : 95.0° F (35.0°C) DB, 75.0° F (23.9°C) WB

HEATING

RETURN AIR TEMPERATURE: 70.0° F (21.1°C) DB, 60.0° F (15.6°C) WB  
 OUTDOOR TEMPERATURE : 47.0° F ( 8.3°C) DB, 43.0° F ( 6.1°C) WB

EXTERNAL STATIC PRESSURE 0.4 in. WG (100Pa)

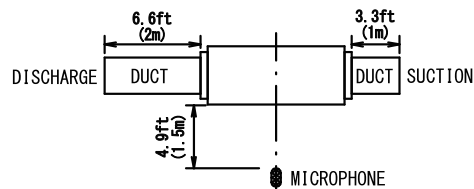

NOTE: OPERATION NOISE DIFFERS WITH OPERATION AND AMBIENT CONDITIONS.

FXMQ30TBVJU

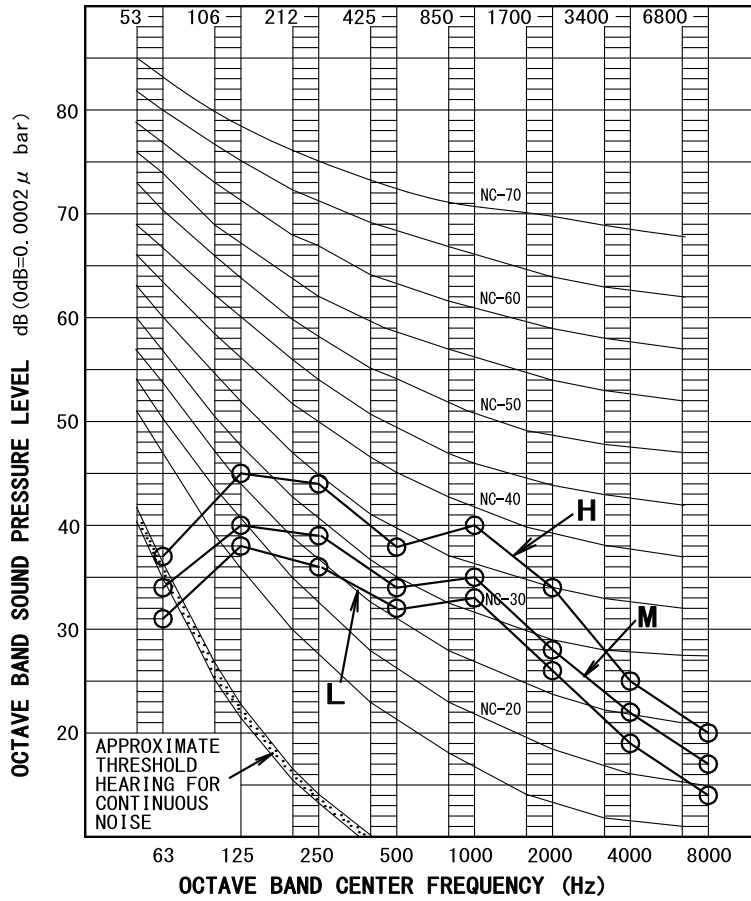

OVER ALL ( dB )

OPERATING CONDITIONS

SCALE	AIRFLOW RATE		
	H	M	L
A	43.0	38.0	36.0

( B. G. N IS ALREADY RECTIFIED )

MEASURING PLACE

ANECHOIC CHAMBER

POWER SOURCE	208 / 230V 60Hz
COOLING	RETURN AIR TEMPERATURE: 80.0° F (26.7°C) DB, 67.0° F (19.4°C) WB OUTDOOR TEMPERATURE : 95.0° F (35.0°C) DB, 75.0° F (23.9°C) WB
HEATING	RETURN AIR TEMPERATURE: 70.0° F (21.1°C) DB, 60.0° F (15.6°C) WB OUTDOOR TEMPERATURE : 47.0° F ( 8.3°C) DB, 43.0° F ( 6.1°C) WB
EXTERNAL STATIC PRESSURE	0.4 in. WG (100Pa)

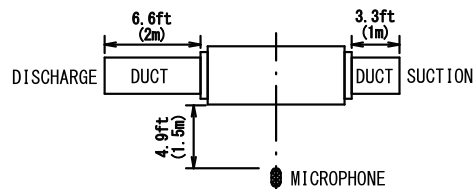

NOTE: OPERATION NOISE DIFFERS WITH OPERATION AND AMBIENT CONDITIONS.

FXMQ36TBVJU

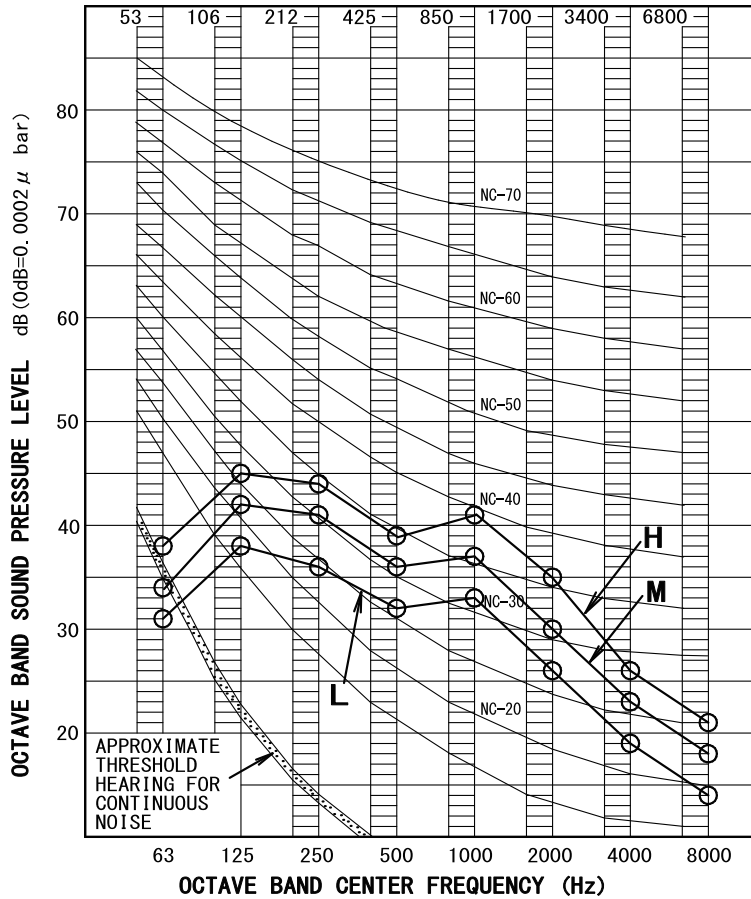

OVER ALL ( dB )

OPERATING CONDITIONS

SCALE	AIRFLOW RATE		
	H	M	L
A	44.0	40.0	36.0

( B. G. N IS ALREADY RECTIFIED )

MEASURING PLACE

ANECHOIC CHAMBER

POWER SOURCE 208 / 230V 60Hz

COOLING

RETURN AIR TEMPERATURE: 80.0° F (26.7°C) DB, 67.0° F (19.4°C) WB

OUTDOOR TEMPERATURE : 95.0° F (35.0°C) DB, 75.0° F (23.9°C) WB

HEATING

RETURN AIR TEMPERATURE: 70.0° F (21.1°C) DB, 60.0° F (15.6°C) WB

OUTDOOR TEMPERATURE : 47.0° F ( 8.3°C) DB, 43.0° F ( 6.1°C) WB

EXTERNAL STATIC PRESSURE 0.4 in. WG (100Pa)

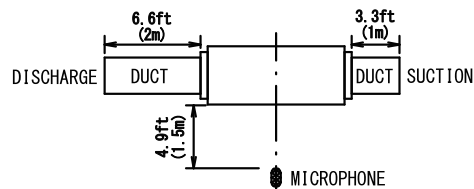

NOTE: OPERATION NOISE DIFFERS WITH OPERATION AND AMBIENT CONDITIONS.

FXMQ48TBVJU

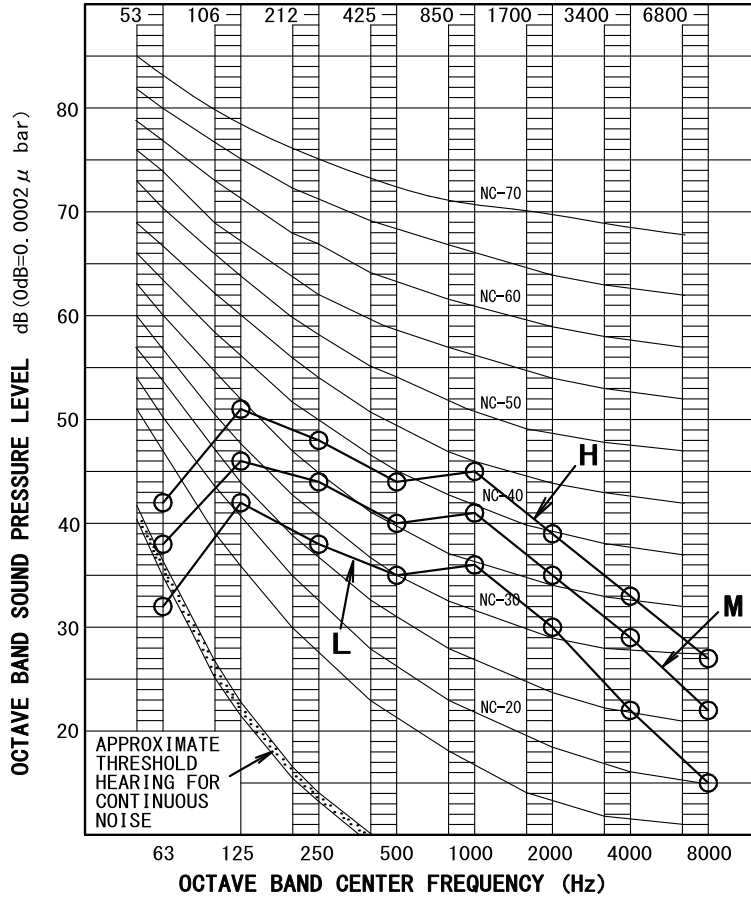

OVER ALL ( dB )

OPERATING CONDITIONS

SCALE	AIRFLOW RATE		
	H	M	L
A	48.0	44.0	39.0

( B. G. N IS ALREADY RECTIFIED )

MEASURING PLACE

ANECHOIC CHAMBER

POWER SOURCE 208 / 230V 60Hz

COOLING

RETURN AIR TEMPERATURE: 80.0° F (26.7°C) DB, 67.0° F (19.4°C) WB  
 OUTDOOR TEMPERATURE : 95.0° F (35.0°C) DB, 75.0° F (23.9°C) WB

HEATING

RETURN AIR TEMPERATURE: 70.0° F (21.1°C) DB, 60.0° F (15.6°C) WB  
 OUTDOOR TEMPERATURE : 47.0° F ( 8.3°C) DB, 43.0° F ( 6.1°C) WB

EXTERNAL STATIC PRESSURE 0.4 in. WG (100Pa)

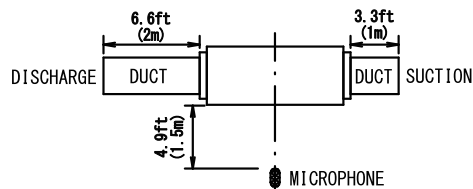

NOTE: OPERATION NOISE DIFFERS WITH OPERATION AND AMBIENT CONDITIONS.



FXMQ54TBVJU

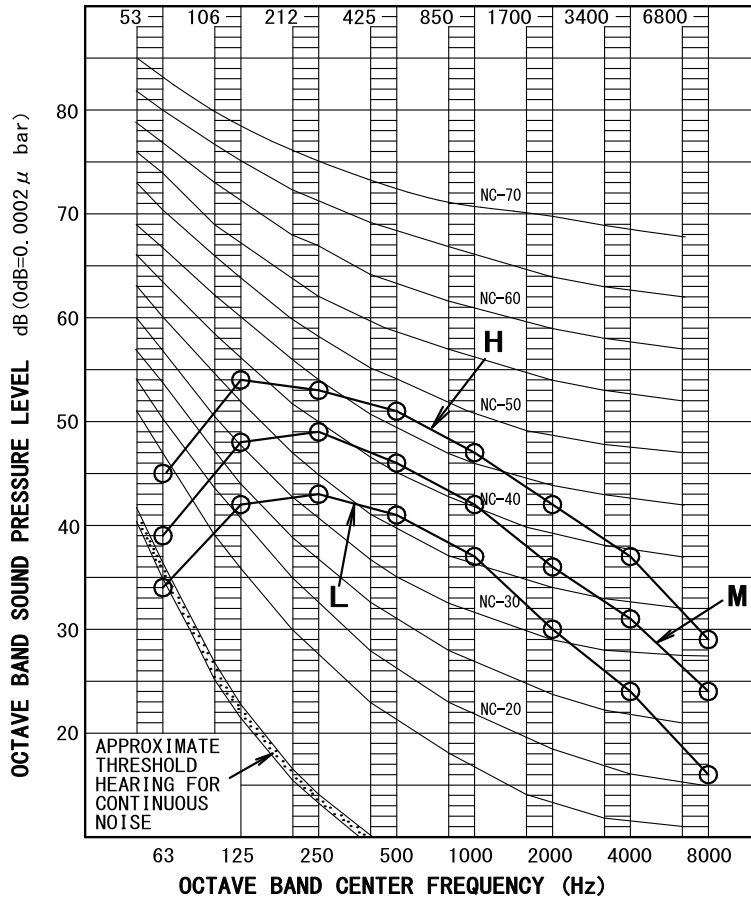

OVER ALL ( dB )

OPERATING CONDITIONS

SCALE	AIRFLOW RATE		
	H	M	L
A	52.0	47.0	42.0

( B. G. N IS ALREADY RECTIFIED )

MEASURING PLACE

ANECHOIC CHAMBER

POWER SOURCE 208 / 230V 60Hz

COOLING

RETURN AIR TEMPERATURE: 80.0° F (26.7°C) DB, 67.0° F (19.4°C) WB  
 OUTDOOR TEMPERATURE : 95.0° F (35.0°C) DB, 75.0° F (23.9°C) WB

HEATING

RETURN AIR TEMPERATURE: 70.0° F (21.1°C) DB, 60.0° F (15.6°C) WB  
 OUTDOOR TEMPERATURE : 47.0° F ( 8.3°C) DB, 43.0° F ( 6.1°C) WB

EXTERNAL STATIC PRESSURE 0.4 in. WG (100Pa)

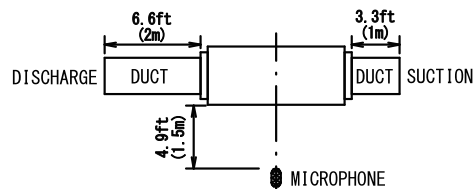

NOTE: OPERATION NOISE DIFFERS WITH OPERATION AND AMBIENT CONDITIONS.

## 13. Accessories

### 13.1 Optional Accessories (for Unit)

Option	FXMQ15TBVJU FXMQ18TBVJU FXMQ24TBVJU	FXMQ30TBVJU FXMQ36TBVJU FXMQ48TBVJU	FXMQ54TBVJU
Shield plate for side plate	KDBD63A160		—

C: 3D140815

### 13.2 Optional Accessories (for Controls)

**Refer to latest Controls Engineering Manual.**

The latest controls engineering manual is available in Daikin City and can be downloaded using the path below.

Document Library → Product Category → VRV → VRV → Engineering Data Manual → “EM-Controls Optional Accessories”

# 14.Auxiliary Electric Heater Setting

## Auxiliary electric heater ON/OFF temperature

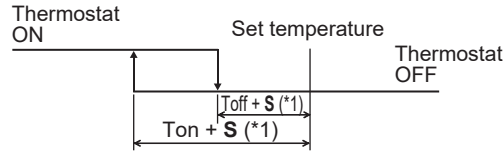

**Note:**

\*1. S value varies automatically based on the room temperature trend.

■ : Factory setting

Mode No.	First Code No.	Symbol	Second Code No.					
			01	02	03	04	05	06
11 (21)	1	Ton	-4°C (-7.2°F)	-3.5°C (-6.3°F)	-3°C (-5.4°F)	-2.5°C (-4.5°F)	-2°C (-3.6°F)	-1.5°C (-2.7°F)
	2	Toff	-2°C (-3.6°F)	-1.5°C (-2.7°F)	-1°C (-1.8°F)	-0.5°C (-0.9°F)	0°C (0°F)	0.5°C (0.9°F)

There is a limitation of combination between Ton and Toff as below due to 2°C (3.6°F) hysteresis required for reliability.

Second Code No.			Ton					
			01	02	03	04	05	06
			-4°C (-7.2°F)	-3.5°C (-6.3°F)	-3°C (-5.4°F)	-2.5°C (-4.5°F)	-2°C (-3.6°F)	-1.5°C (-2.7°F)
Toff	06	0.5°C (0.9°F)	●	●	●	●	●	●
	05	0°C (0°F)	●	●	●	●	●	—
	04	-0.5°C (-0.9°F)	●	●	●	●	—	—
	03	-1°C (-1.8°F)	●	●	●	—	—	—
	02	-1.5°C (-2.7°F)	●	●	—	—	—	—
	01	-2°C (-3.6°F)	●	—	—	—	—	—

●: Available  
 —: Not available











**Warning** ● Ask a qualified installer or contractor to install this product. Do not try to install the product yourself.



Improper installation can result in water or refrigerant leakage, electrical shock, fire or explosion.

- Use only those parts and accessories supplied or specified by Daikin. Ask a qualified installer or contractor to install those parts and accessories. Use of unauthorised parts and accessories or improper installation of parts and accessories can result in water or refrigerant leakage, electrical shock, fire or explosion.
- Read the user's manual carefully before using this product. The user's manual provides important safety instructions and warnings. Be sure to follow these instructions and warnings.

If you have any inquiries, please contact your local importer, distributor and/or retailer.

### **Cautions on product corrosion**

1. Air conditioners should not be installed in areas where corrosive gases, such as acid gas or alkaline gas, are produced.
2. If the outdoor unit is to be installed close to the sea shore, direct exposure to the sea breeze should be avoided. If you need to install the outdoor unit close to the sea shore, contact your local distributor.