



EDUS122205

R-410A

Engineering Data

Multi-Split Type Air Conditioners - Heat Pump -

2/3/4/5MXS-W, 2/3/4MXL-W, 2/3/4MXLH-W Series



INVERTER

Part 1 Multi-Split Type Air Conditioners	1
1. Power Supply	2
2. Functions	3
2.1 Indoor unit	3
2.2 Outdoor unit	5
3. Specification	6
3.1 Indoor unit	6
3.2 Outdoor unit	14
3.3 Combination Capacity	20
4. Dimensions	21
4.1 Indoor unit	21
4.2 Outdoor unit	29
5. Wiring Diagram	32
5.1 Indoor unit	32
5.2 Outdoor unit	36
6. Piping Diagram	40
6.1 Indoor unit	40
6.2 Outdoor unit	43
7. Capacity Table	46
8. Operation Limit	47
9. Fan Characteristics	48
9.1 External Static Pressure	48
9.2 Airflow Auto Adjustment	54
10. Sound Level	57
10.1 Measuring Location	57
10.2 Indoor unit	58
10.3 Outdoor unit	68
11. Electric Characteristics	72
Part 2 Installation Manual	73
1. Indoor Unit	74
1.1 CTXS, FTXS09/12	74
1.2 FTXS15/18/24	87
1.3 FTXR	100
1.4 FVXS	114
1.5 CDMQ, FDMQ	132
1.6 FFQ	156
2. Outdoor Unit	182
2.1 2/3/4MXS, 2/3MXL, 2/3MXLH	182
2.2 5MXS, 4MXL, 4MXLH	200

3. Remote Controller (Required Option for CDMQ, FDMQ, FFQ).....	218
3.1 BRC1E73	218
3.2 BRC082A43 for CDMQ, FDMQ.....	239
3.3 BRC082A41W, BRC982A42W(S) for FFQ	244
Part 3 Operation Manual.....	251
1. Operation Manual List	252
2. Operation Manual.....	254
2.1 CTXS, FTXS.....	254
2.2 FTXR	293
2.3 FVXS	330
2.4 CDMQ, FDMQ.....	366
2.5 FFQ	376
2.6 BRC1E73	388
2.7 BRC082A43 for CDMQ, FDMQ.....	438
2.8 BRC082A41W, BRC982A42W(S) for FFQ	446
Part 4 Options	455
1. Options List	457
1.1 Indoor Unit.....	457
1.2 Outdoor Unit.....	459
2. Control Devices	460
2.1 <BRC944B2> Wired Remote Controller (Installation).....	460
2.2 <BRC944B2> Wired Remote Controller (Operation)	462
2.3 <BRCW901A03/08> Wired Remote Controller Cord	474
2.4 <KRP413BB1S> Wiring Adaptor.....	475
2.5 <DCS302C71> Central Remote Controller (Installation)	479
2.6 <DCS302C71> Central Remote Controller (Operation).....	484
2.7 <DCS301C71> Unified ON/OFF Controller (Installation).....	510
2.8 <DCS301C71> Unified ON/OFF Controller (Operation)	515
2.9 <DST301BA61> Schedule Timer Controller (Installation).....	517
2.10 <DST301BA61> Schedule Timer Controller (Operation)	522
2.11 <KRP928BB2S> Interface Adaptor for DIII-NET.....	535
2.12 <KRP1C74/75> Wiring Adaptor	538
2.13 <KRP4A74> Wiring Adaptor.....	539
2.14 <KRP4A98> Installation Box for Adaptor PCB.....	544
2.15 <KRP1BA101> Installation Box for Adaptor PCB	546
2.16 <KRCS01-4B> Remote Sensor.....	548
3. Indoor Unit.....	551
3.1 <BRYQ60A2W(S)> Sensor Kit.....	551
3.2 <KDBQ44BA60A> Panel Spacer	553

3.3 <BDBHQ44C60> Sealing Member.....	555
3.4 <KDDQ44XA60> Fresh Air Intake Kit	557
4. Outdoor Unit	559
4.1 <KPW063B4> Air Direction Adjustment Grille.....	559
4.2 <KPW082A41> Air Direction Adjustment Grille.....	561
4.3 <KKG063A42> Back Protection Wire Net.....	563
4.4 <KKG082A41> Back Protection Wire Net.....	564
4.5 <BKP082A41> Drain Plug.....	566
4.6 <KEH063A4E> Drain Pan Heater	568
4.7 <KEH082A41> Drain Pan Heater.....	578
4.8 <KPS063A41> Snow Hood (Side)	582
4.9 <KPS063A44> Snow Hood (Rear).....	584
4.10 <KPS063A47> Snow Hood (Discharge)	586

Part 1 Multi-Split Type Air Conditioners

1. Power Supply.....	2
2. Functions	3
2.1 Indoor unit.....	3
2.2 Outdoor unit	5
3. Specification	6
3.1 Indoor unit.....	6
3.2 Outdoor unit	14
3.3 Combination Capacity.....	20
4. Dimensions	21
4.1 Indoor unit.....	21
4.2 Outdoor unit	29
5. Wiring Diagram	32
5.1 Indoor unit.....	32
5.2 Outdoor unit	36
6. Piping Diagram	40
6.1 Indoor unit.....	40
6.2 Outdoor unit	43
7. Capacity Table.....	46
8. Operation Limit	47
9. Fan Characteristics.....	48
9.1 External Static Pressure	48
9.2 Airflow Auto Adjustment.....	54
10. Sound Level.....	57
10.1 Measuring Location	57
10.2 Indoor unit.....	58
10.3 Outdoor unit	68
11. Electric Characteristics	72

1 Power Supply

Indoor Unit		Outdoor Unit	Power Supply
Wall Mounted Type CTXS, FTXS, FTXR Series	CTXS07WVJU9	Standard Type	1 phase, 208 - 230 V, 60 Hz
	FTXS09WVJU9	2MXS18WMVJU9	
	FTXS12WVJU9	3MXS24WMVJU9	
	FTXS15WVJU9	4MXS36WMVJU9	
	FTXS18WVJU9	5MXS48WVJU9	
	FTXS24WVJU9		
	FTXR09WVJUW9	Cold Climate Type	
	FTXR09WVJUS9	2MXL18WMVJU9	
	FTXR12WVJUW9	3MXL24WMVJU9	
	FTXR12WVJUS9	4MXL36WVJU9	
	FTXR18WVJUW9	2MXLH18WVJU9 (with drain pan heater)	
FTXR18WVJUS9	3MXLH24WVJU9 (with drain pan heater)		
Floor Standing Type FVXS Series	FVXS09WVJU9	4MXLH36WVJU9 (with drain pan heater)	
	FVXS12WVJU9		
	FVXS15WVJU9		
	FVXS18WVJU9		
Duct Connected Type CDMQ, FDMQ Series	CDMQ07WVJU9		
	FDMQ09WVJU9		
	FDMQ12WVJU9		
	FDMQ15WVJU9		
	FDMQ18WVJU9		
	FDMQ24WVJU9		
Ceiling-mounted Cassette Type FFQ Series	FFQ09W2VJU9		
	FFQ12W2VJU9		
	FFQ15W2VJU9		
	FFQ18W2VJU9		

Note: Power Supply Intake ; Outdoor Unit



Cautions

1. Air conditioners should not be installed in areas where corrosive gasses, such as acid gas or alkaline gas, are produced.
2. If the outdoor unit is to be installed close to the sea shore, direct exposure to the sea breeze should be avoided and choose an outdoor unit with anti-corrosion treatment.

2 Functions

2.1 Indoor unit

Category	Functions	Wall Mounted			Floor Standing
		CTXS	FTXS	FTXR	FVXS
Basic Function	Inverter (with inverter power control)	●	●	●	●
Comfortable Airflow	Power-airflow dual flaps (horizontal blade)	●	●	●	—
	Wide-angle louvers (vertical blades)	●	●	●	●
	Auto-swing (up and down)	●	●	●	●
	Auto-swing (left and right)	●	●	●	—
	3-D airflow	●	●	●	—
	COMFORT AIRFLOW operation	●	●	●	—
Comfort Control	Auto fan speed	●	●	●	●
	Switchable fan speed	●	●	●	●
	Indoor unit quiet operation	●	●	●	●
	INTELLIGENT EYE operation	●	●	—	—
	2-area INTELLIGENT EYE operation	—	—	●	—
	Hot-start function	●	●	●	●
Operation	Automatic cooling/heating changeover	●	●	●	●
	Program dry operation	●	●	●	●
	Fan only	●	●	●	●
Lifestyle Convenience	POWERFUL operation (inverter)	●	●	●	●
	ECONO operation	●	●	●	●
	Indoor unit ON/OFF switch	●	●	●	●
	Multi-colored indicator lamp	—	—	●	—
	Monitor brightness setting	—	—	●	—
	Signal receiving sign	●	●	●	●
	R/C with back light	●	●	●	●
Health and Cleanliness	Titanium apatite deodorizing filter	●	●	●	●
	Mold proof air filter	●	●	●	●
	Wipe-clean flat panel	●	●	●	●
	Washable grille	—	—	—	—
Timer	WEEKLY TIMER operation	●	●	●	●
	24-hour ON/OFF TIMER	●	●	●	●
	72-hour ON/OFF TIMER	—	—	—	—
	NIGHT SET mode	●	●	●	●
Worry Free (Reliability & Durability)	Auto-restart (after power failure)	●	●	●	●
	Self-diagnosis (R/C, LED)	●	●	●	●
Flexibility	Multi-split/split type compatible indoor unit	—	—	●	●
	Either side drain (left or right)	●	●	●	—
	°F/°C changeover R/C temperature display (factory setting: °F)	●	●	●	●
Remote Control	Remote control adaptor (normal open pulse contact)	Option	Option	Option	Option
	Remote control adaptor (normal open contact)	Option	Option	Option	Option
	DIII-NET compatible (adaptor)	Option	Option	Option	Option
	Wireless LAN connection	Option	Option	Option	Option
Remote Controller	Wireless	●	●	●	●
	Wired	Option	Option	Option	—

Notes: ●: Available

—: Not available

Category	Functions	Duct CDMQ/FDMQ		Ceiling Cassette FFQ with BYFQ60B3W1		Ceiling Cassette FFQ with BYFQ60C2W1W(S)	
		Wired R/C	Wireless R/C	Wired R/C	Wireless R/C	Wired R/C	Wireless R/C
Basic Function	Inverter (with inverter power control)	●	●	●	●	●	●
Comfortable Airflow	Auto-swing	—	—	●	●	●	●
	Individual flap control	—	—	—	—	●	—
	COMFORT AIRFLOW operation	—	—	—	—	—	—
Comfort Control	Auto fan speed	●	—	●	—	●	—
	Switchable fan speed	3 steps	3 steps	3 steps	3 steps	3 steps	3 steps
	2 selectable temperature sensors	●	—	—	—	—	—
	Presence and floor sensor	—	—	—	—	Option	—
	Hot-start function	●	●	●	●	●	●
	Draft prevention	—	—	●	●	●	●
Operation	Automatic cooling/heating changeover	●	●	●	●	●	●
	Program dry operation	●	●	●	●	●	●
	Fan only	●	●	●	●	●	●
	Setback function	—	—	●	—	●	—
Lifestyle Convenience	Emergency operation switch	—	●	—	●	—	●
	Signal receiving sign	—	●★1	—	●★1	—	●★1
	R/C with back light	●	—	●	—	●	—
	Temperature display	—	—	—	—	—	—
Health and Cleanliness	Longlife filter	Option	Option	Option	Option	Option	Option
	Filter cleaning indicator	●	●	●	●	●	●
	Wipe-clean flat panel	—	—	—	—	—	—
	Silver ion anti-bacterial drain pan	●	●	—	—	—	—
	Washable grille	—	—	●	●	●	●
Timer	Setpoint auto reset	●	—	—	—	—	—
	Setpoint range restriction	●	—	—	—	—	—
	Schedule TIMER operation	●	—	●	—	●	—
	24-hour ON/OFF TIMER	●	—	●	—	●	—
	72-hour count up/down ON/OFF TIMER	—	●	—	●	—	●
	Off Timer (turns unit off after set time)	●	—	●	—	●	—
	NIGHT SET mode	—	—	—	—	—	—
Worry Free (Reliability & Durability)	Auto-restart (after power failure)	●	●	●	●	●	●
	Self-diagnosis (R/C, LED)	●	●	●	●	●	●
Flexibility	Multi-split/split type compatible indoor unit	●★2	●★2	●	●	●	●
	Drain pump	●	●	●	●	●	●
	°F/°C changeover R/C temperature display (factory setting: °F)	●	—	●	—	●	—
Remote Control	Remote control adaptor (normal open pulse contact)	—	—	—	—	—	—
	Remote control adaptor (normal open contact)	—	—	—	—	—	—
	DIII-NET compatible (adaptor)	Option	Option	Option	Option	Option	Option
	Wireless LAN connection	Option	Option	Option	Option	Option	Option

Note:

- : Available
- : Not available
- ★1: Receiving sound only
- ★2: FDMQ only

2.2 Outdoor unit

Function	Standard			Cold Climate					
	2MXS	3/4MXS	5MXS	2MXL	3MXL	4MXL	2MXLH	3MXLH	4MXLH
Inverter (with inverter power control)	●	●	●	●	●	●	●	●	●
Operation limit	Refer to P.47								
PAM control	●	●	●	●	●	●	●	●	●
Standby electricity saving	—	—	—	—	—	—	—	—	—
Swing compressor	●	●	●	●	●	●	●	●	●
Reluctance DC motor	●	●	●	●	●	●	●	●	●
NIGHT QUIET mode	●	●	●	●	●	●	●	●	●
QUIET OUTDOOR UNIT operation	●	●	●	●	●	●	●	●	●
Quick warming function	●	●	●	●	●	●	●	●	●
Automatic defrosting	●	●	●	●	●	●	●	●	●
Defrost learning control	—	—	●	—	—	●	—	—	●
Priority room setting	●	●	●	●	●	●	●	●	●
COOL/HEAT mode lock	●	●	●	●	●	●	●	●	●
Self-diagnosis (R/C, LED)	●	●	●	●	●	●	●	●	●
Wiring error check function	●	●	●	●	●	●	●	●	●
Anti-corrosion treatment of outdoor heat exchanger	●	●	●	●	●	●	●	●	●
Drain pan heater	Option	Option	Option	Option	Option	Option	●	●	●
Drain pan heater control by microcomputer	—	—	●	—	—	●	●	●	●
Chargeless	98.4 ft (30 m)	131.2 ft (40 m)	131.2 ft (40 m)	98.4 ft (30 m)	131.2 ft (40 m)	131.2 ft (40 m)	98.4 ft (30 m)	131.2 ft (40 m)	131.2 ft (40 m)
Low temp. cooling operation (−15°C) (5°F)	—	—	—	—	—	—	—	—	—

Note: ●: Available

—: Not available

3 Specification

3.1 Indoor unit

3.1.1 Wall Mounted Type

Model			CTXS07WVJU9		FTXS09WVJU9	
			Cooling	Heating	Cooling	Heating
Power Supply		Phase	1φ		1φ	
		Hz, V	60 Hz, 208 - 230 V		60 Hz, 208 - 230 V	
Rated Capacity			7 kBtu/h Class		9 kBtu/h Class	
Front Panel Color			White		White	
Airflow Rates	H	cfm (m³/min)	332 (9.4)	350 (9.9)	381 (10.8)	420 (11.9)
	M		261 (7.4)	290 (8.2)	279 (7.9)	321 (9.1)
	L		194 (5.5)	233 (6.6)	194 (5.5)	233 (6.6)
	SL		145 (4.1)	219 (6.2)	145 (4.1)	219 (6.2)
Fan	Type		Cross Flow Fan		Cross Flow Fan	
	Motor Output	HP	0.03		0.03	
	Speed	Steps	5 Steps, Quiet, Auto		5 Steps, Quiet, Auto	
Air Direction Control			Right, Left, Horizontal, Downward		Right, Left, Horizontal, Downward	
Air Filter			Removable, Washable		Removable, Washable	
Running Current (Rated)		A	0.09 - 0.08	0.11 - 0.10	0.09 - 0.08	0.11 - 0.10
Power Consumption (Rated)		W	18 - 18	21 - 21	18 - 18	21 - 21
Power Factor (Rated)		%	96.2 - 97.8	91.8 - 91.3	96.2 - 97.8	91.8 - 91.3
Temperature Control			Microcomputer Control		Microcomputer Control	
Dimensions (H × W × D)		in. (mm)	11-5/8 × 31-1/2 × 8-7/16 (295 × 800 × 215)		11-5/8 × 31-1/2 × 8-7/16 (295 × 800 × 215)	
Packaged Dimensions (H × W × D)		in. (mm)	10-13/16 × 34-1/4 × 14-7/16 (274 × 870 × 366)		10-13/16 × 34-1/4 × 14-7/16 (274 × 870 × 366)	
Weight (Mass)		lbs (kg)	20 (9)		20 (9)	
Gross Weight (Gross Mass)		lbs (kg)	28 (13)		28 (13)	
Sound Pressure Level	H / M / L / SL	dB(A)	38 / 32 / 25 / 22	38 / 33 / 28 / 25	41 / 33 / 25 / 22	42 / 35 / 38 / 25
Sound Power Level		dB	54	54	57	58
Heat Insulation			Both Liquid and Gas Pipes		Both Liquid and Gas Pipes	
Piping Connection	Liquid	in. (mm)	φ 1/4 (φ 6.4)		φ 1/4 (φ 6.4)	
	Gas	in. (mm)	φ 3/8 (φ 9.5)		φ 3/8 (φ 9.5)	
	Drain	in. (mm)	φ 5/8 (φ 16)		φ 5/8 (φ 16)	
Drawing No.			3D141140B		3D141140B	
Note			SL: The quiet fan level of the airflow rate setting		SL: The quiet fan level of the airflow rate setting	

Model			FTXS12WVJU9		FTXS15WVJU9	
			Cooling	Heating	Cooling	Heating
Power Supply		Phase	1φ		1φ	
		Hz, V	60 Hz, 208 - 230 V		60 Hz, 208 - 230 V	
Rated Capacity			12 kBtu/h Class		15 kBtu/h Class	
Front Panel Color			White		White	
Airflow Rates	H	cfm (m³/min)	403 (11.4)	438 (12.4)	568 (16.1)	593 (16.8)
	M		307 (8.7)	335 (9.5)	477 (13.5)	505 (14.3)
	L		205 (5.8)	240 (6.8)	385 (10.9)	417 (11.8)
	SL		155 (4.4)	212 (6.0)	360 (10.2)	371 (10.5)
Fan	Type		Cross Flow Fan		Cross Flow Fan	
	Motor Output	HP	0.03		0.06	
	Speed	Steps	5 Steps, Quiet, Auto		5 Steps, Quiet, Auto	
Air Direction Control			Right, Left, Horizontal, Downward		Right, Left, Horizontal, Downward	
Air Filter			Removable, Washable		Removable, Washable	
Running Current (Rated)		A	0.13 - 0.12	0.14 - 0.13	0.31 - 0.29	0.31 - 0.29
Power Consumption (Rated)		W	26 - 26	28 - 28	38 - 38	38 - 38
Power Factor (Rated)		%	96.2 - 94.2	96.2 - 93.6	58.9 - 57.0	58.9 - 57.0
Temperature Control			Microcomputer Control		Microcomputer Control	
Dimensions (H × W × D)		in. (mm)	11-5/8 × 31-1/2 × 8-7/16 (295 × 800 × 215)		13-3/8 × 41-5/16 × 9-3/4 (340 × 1,050 × 248)	
Packaged Dimensions (H × W × D)		in. (mm)	10-13/16 × 34-1/4 × 14-7/16 (274 × 870 × 366)		13 × 45-11/16 × 16-7/8 (331 × 1,160 × 429)	
Weight (Mass)		lbs (kg)	21 (10)		31 (14)	
Gross Weight (Gross Mass)		lbs (kg)	29 (13)		43 (19)	
Sound Pressure Level	H / M / L / SL	dB(A)	45 / 37 / 29 / 23	45 / 39 / 29 / 26	45 / 40 / 35 / 32	43 / 38 / 33 / 30
Sound Power Level		dB	61	61	61	59
Heat Insulation			Both Liquid and Gas Pipes		Both Liquid and Gas Pipes	
Piping Connection	Liquid	in. (mm)	φ 1/4 (φ 6.4)		φ 1/4 (φ 6.4)	
	Gas	in. (mm)	φ 3/8 (φ 9.5)		φ 1/2 (φ 12.7)	
	Drain	in. (mm)	φ 5/8 (φ 16)		φ 5/8 (φ 16)	
Drawing No.			3D141140B		3D141475A	
Note			SL: The quiet fan level of the airflow rate setting		SL: The quiet fan level of the airflow rate setting	

Conversion Formulae
kcal/h = kW × 860
Btu/h = kW × 3412
cfm = m³/min × 35.3

Model			FTXS18WVJU9		FTXS24WVJU9	
			Cooling	Heating	Cooling	Heating
Power Supply	Phase		1φ		1φ	
	Hz, V		60 Hz, 208 - 230 V		60 Hz, 208 - 230 V	
Rated Capacity			18 kBtu/h Class		24 kBtu/h Class	
Front Panel Color			White		White	
Airflow Rates	H	cfm (m³/min)	583 (16.5)	625 (17.7)	643 (18.2)	699 (19.8)
	M		484 (13.7)	526 (14.9)	494 (14.0)	572 (16.2)
	L		385 (10.9)	431 (12.2)	350 (9.9)	445 (12.6)
	SL		360 (10.2)	399 (11.3)	328 (9.3)	403 (11.4)
Fan	Type		Cross Flow Fan		Cross Flow Fan	
	Motor Output	HP	0.06		0.06	
	Speed	Steps	5 Steps, Quiet, Auto		5 Steps, Quiet, Auto	
Air Direction Control			Right, Left, Horizontal, Downward		Right, Left, Horizontal, Downward	
Air Filter			Removable, Washable		Removable, Washable	
Running Current (Rated)	A		0.32 - 0.30	0.32 - 0.30	0.57 - 0.51	0.57 - 0.51
Power Consumption (Rated)	W		38 - 38	38 - 38	69 - 68	69 - 68
Power Factor (Rated)	%		57.1 - 55.1	57.1 - 55.1	58.2 - 58.0	58.2 - 58.0
Temperature Control			Microcomputer Control		Microcomputer Control	
Dimensions (H × W × D)	in. (mm)		13-3/8 × 41-5/16 × 9-3/4 (340 × 1,050 × 248)		13-3/8 × 41-5/16 × 9-3/4 (340 × 1,050 × 248)	
Packaged Dimensions (H × W × D)	in. (mm)		13 × 45-11/16 × 16-7/8 (331 × 1,160 × 429)		13 × 45-11/16 × 16-7/8 (331 × 1,160 × 429)	
Weight (Mass)	lbs (kg)		31 (14)		31 (14)	
Gross Weight (Gross Mass)	lbs (kg)		43 (19)		45 (20)	
Sound Pressure Level	H / M / L / SL	dB(A)	46 / 41 / 36 / 33	45 / 40 / 35 / 32	51 / 44 / 37 / 34	48 / 42 / 37 / 34
Sound Power Level		dB	62	61	67	64
Heat Insulation			Both Liquid and Gas Pipes		Both Liquid and Gas Pipes	
Piping Connection	Liquid	in. (mm)	φ 1/4 (φ 6.4)		φ 1/4 (φ 6.4)	
	Gas	in. (mm)	φ 1/2 (φ 12.7)		φ 5/8 (φ 15.9)	
	Drain	in. (mm)	φ 5/8 (φ 16)		φ 5/8 (φ 16)	
Drawing No.			3D141475A		3D141475A	
Note			SL: The quiet fan level of the airflow rate setting		SL: The quiet fan level of the airflow rate setting	

Model			FTXR09WVJU9		FTXR09WVJUS9	
			Cooling	Heating	Cooling	Heating
Power Supply	Phase		1φ		1φ	
	Hz, V		60 Hz, 208 - 230 V		60 Hz, 208 - 230 V	
Rated Capacity			9 kBtu/h Class		9 kBtu/h Class	
Front Panel Color			White		Silver	
Airflow Rates	H	cfm (m³/min)	272 (7.7)	346 (9.8)	272 (7.7)	346 (9.8)
	M		208 (5.9)	258 (7.3)	208 (5.9)	258 (7.3)
	L		162 (4.6)	201 (5.7)	162 (4.6)	201 (5.7)
	SL		134 (3.8)	117 (3.3)	134 (3.8)	117 (3.3)
Fan	Type		Cross Flow Fan		Cross Flow Fan	
	Motor Output	HP	0.04		0.04	
	Speed	Steps	5 Steps, Quiet, Auto		5 Steps, Quiet, Auto	
Air Direction Control			Right, Left, Horizontal, Downward		Right, Left, Horizontal, Downward	
Air Filter			Removable, Washable		Removable, Washable	
Running Current (Rated)	A		0.07 - 0.07	0.13 - 0.12	0.07 - 0.07	0.13 - 0.12
Power Consumption (Rated)	W		13 - 13	26 - 26	13 - 13	26 - 26
Power Factor (Rated)	%		89.2 - 80.7	96.2 - 94.2	89.2 - 80.7	96.2 - 94.2
Temperature Control			Microcomputer Control		Microcomputer Control	
Dimensions (H × W × D)	in. (mm)		11-15/16 × 39-5/16 × 8-3/8 (303 × 998 × 212)		11-15/16 × 39-5/16 × 8-3/8 (303 × 998 × 212)	
Packaged Dimensions (H × W × D)	in. (mm)		12-11/16 × 43-3/8 × 15-5/16 (322 × 1,101 × 389)		12-11/16 × 43-3/8 × 15-5/16 (322 × 1,101 × 389)	
Weight (Mass)	lbs (kg)		27 (12)		27 (12)	
Gross Weight (Gross Mass)	lbs (kg)		33 (15)		33 (15)	
Sound Pressure Level	H / M / L / SL	dB(A)	38 / 32 / 25 / 19	41 / 34 / 28 / 19	38 / 32 / 25 / 19	41 / 34 / 28 / 19
Sound Power Level		dB	—	—	—	—
Heat Insulation			Both Liquid and Gas Pipes		Both Liquid and Gas Pipes	
Piping Connection	Liquid	in. (mm)	φ 1/4 (φ 6.4)		φ 1/4 (φ 6.4)	
	Gas	in. (mm)	φ 3/8 (φ 9.5)		φ 3/8 (φ 9.5)	
	Drain	in. (mm)	φ 11/16 (φ 18)		φ 11/16 (φ 18)	
Drawing No.			3D143145		3D143145	
Note			SL: The quiet fan level of the airflow rate setting		SL: The quiet fan level of the airflow rate setting	

Conversion Formulae
kcal/h = kW × 860
Btu/h = kW × 3412
cfm = m³/min × 35.3

Model			FTXR12WVJUW9		FTXR12WVJUS9	
			Cooling	Heating	Cooling	Heating
Power Supply	Phase		1φ		1φ	
	Hz, V		60 Hz, 208 - 230 V		60 Hz, 208 - 230 V	
Rated Capacity			12 kBtu/h Class		12 kBtu/h Class	
Front Panel Color			White		Silver	
Airflow Rates	H	cfm (m ³ /min)	335 (9.5)	395 (11.2)	335 (9.5)	395 (11.2)
	M		219 (6.2)	290 (8.2)	219 (6.2)	290 (8.2)
	L		169 (4.8)	226 (6.4)	169 (4.8)	226 (6.4)
	SL		131 (3.7)	131 (3.7)	131 (3.7)	131 (3.7)
Fan	Type		Cross Flow Fan		Cross Flow Fan	
	Motor Output	HP	0.04		0.04	
	Speed	Steps	5 Steps, Quiet, Auto		5 Steps, Quiet, Auto	
Air Direction Control			Right, Left, Horizontal, Downward		Right, Left, Horizontal, Downward	
Air Filter			Removable, Washable		Removable, Washable	
Running Current (Rated)	A		0.13 - 0.12	0.19 - 0.17	0.13 - 0.12	0.19 - 0.17
Power Consumption (Rated)	W		26 - 26	38 - 38	26 - 26	38 - 38
Power Factor (Rated)	%		96.1 - 94.2	96.1 - 97.1	96.1 - 94.2	96.1 - 97.1
Temperature Control			Microcomputer Control		Microcomputer Control	
Dimensions (H × W × D)	in. (mm)		11-15/16 × 39-5/16 × 8-3/8 (303 × 998 × 212)		11-15/16 × 39-5/16 × 8-3/8 (303 × 998 × 212)	
Packaged Dimensions (H × W × D)	in. (mm)		12-11/16 × 43-3/8 × 15-5/16 (322 × 1,101 × 389)		12-11/16 × 43-3/8 × 15-5/16 (322 × 1,101 × 389)	
Weight (Mass)	lbs (kg)		27 (12)		27 (12)	
Gross Weight (Gross Mass)	lbs (kg)		33 (15)		33 (15)	
Sound Pressure Level	H / M / L / SL	dB(A)	45 / 34 / 26 / 20	45 / 37 / 29 / 20	45 / 34 / 26 / 20	45 / 37 / 29 / 20
Sound Power Level		dB	—	—	—	—
Heat Insulation			Both Liquid and Gas Pipes		Both Liquid and Gas Pipes	
Piping Connection	Liquid	in. (mm)	φ 1/4 (φ 6.4)		φ 1/4 (φ 6.4)	
	Gas	in. (mm)	φ 3/8 (φ 9.5)		φ 3/8 (φ 9.5)	
	Drain	in. (mm)	φ 11/16 (φ 18)		φ 11/16 (φ 18)	
Drawing No.			3D143146		3D143146	
Note			SL: The quiet fan level of the airflow rate setting		SL: The quiet fan level of the airflow rate setting	

Model			FTXR18WVJUW9		FTXR18WVJUS9	
			Cooling	Heating	Cooling	Heating
Power Supply	Phase		1φ		1φ	
	Hz, V		60 Hz, 208 - 230 V		60 Hz, 208 - 230 V	
Rated Capacity			18 kBtu/h Class		18 kBtu/h Class	
Front Panel Color			White		Silver	
Airflow Rates	H	cfm (m ³ /min)	350 (9.9)	413 (11.7)	350 (9.9)	413 (11.7)
	M		275 (7.8)	332 (9.4)	275 (7.8)	332 (9.4)
	L		226 (6.4)	275 (7.8)	226 (6.4)	275 (7.8)
	SL		208 (5.9)	208 (5.9)	208 (5.9)	208 (5.9)
Fan	Type		Cross Flow Fan		Cross Flow Fan	
	Motor Output	HP	0.04		0.04	
	Speed	Steps	5 Steps, Quiet, Auto		5 Steps, Quiet, Auto	
Air Direction Control			Right, Left, Horizontal, Downward		Right, Left, Horizontal, Downward	
Air Filter			Removable, Washable		Removable, Washable	
Running Current (Rated)	A		0.14 - 0.14	0.21 - 0.21	0.14 - 0.14	0.21 - 0.21
Power Consumption (Rated)	W		28 - 28	42 - 42	28 - 28	42 - 42
Power Factor (Rated)	%		96.1 - 87.0	96.2 - 87.0	96.1 - 87.0	96.2 - 87.0
Temperature Control			Microcomputer Control		Microcomputer Control	
Dimensions (H × W × D)	in. (mm)		11-15/16 × 39-5/16 × 8-3/8 (303 × 998 × 212)		11-15/16 × 39-5/16 × 8-3/8 (303 × 998 × 212)	
Packaged Dimensions (H × W × D)	in. (mm)		12-11/16 × 43-3/8 × 15-5/16 (322 × 1,101 × 389)		12-11/16 × 43-3/8 × 15-5/16 (322 × 1,101 × 389)	
Weight (Mass)	lbs (kg)		27 (12)		27 (12)	
Gross Weight (Gross Mass)	lbs (kg)		33 (15)		33 (15)	
Sound Pressure Level	H / M / L / SL	dB(A)	46 / 40 / 35 / 30	47 / 41 / 35 / 30	46 / 40 / 35 / 30	47 / 41 / 35 / 30
Sound Power Level		dB	—	—	—	—
Heat Insulation			Both Liquid and Gas Pipes		Both Liquid and Gas Pipes	
Piping Connection	Liquid	in. (mm)	φ 1/4 (φ 6.4)		φ 1/4 (φ 6.4)	
	Gas	in. (mm)	φ 1/2 (φ 12.7)		φ 1/2 (φ 12.7)	
	Drain	in. (mm)	φ 11/16 (φ 18)		φ 11/16 (φ 18)	
Drawing No.			3D143147		3D143147	
Note			SL: The quiet fan level of the airflow rate setting		SL: The quiet fan level of the airflow rate setting	

Conversion Formulae
kcal/h = kW × 860
Btu/h = kW × 3412
cfm = m ³ /min × 35.3

3.1.2 Floor Standing Type

Model			FVXS09VVJU9		FVXS12VVJU9	
			Cooling	Heating	Cooling	Heating
Power Supply		Phase	1 ϕ		1 ϕ	
		Hz, V	60 Hz, 208 - 230 V		60 Hz, 208 - 230 V	
Rated Capacity			9 kBtu/h Class		12 kBtu/h Class	
Front Panel Color			White		White	
Airflow Rates	H	cfm (m ³ /min)	290(8.2)	311 (8.8)	300 (8.5)	332 (9.4)
	M		230 (6.5)	244 (6.9)	237 (6.7)	258 (7.3)
	L		169 (4.8)	177 (5.0)	173 (4.9)	184 (5.2)
	SL		145 (4.1)	155 (4.4)	159 (4.5)	166 (4.7)
Fan	Type		Turbo Fan		Turbo Fan	
	Motor Output	HP	0.02		0.02	
	Speed	Steps	5 Steps, Quiet, Auto		5 Steps, Quiet, Auto	
Air Direction Control			Right, Left, Horizontal, Downward		Right, Left, Horizontal, Downward	
Air Filter			Removable, Washable		Removable, Washable	
Running Current (Rated)		A	0.14 - 0.13	0.15 - 0.14	0.14 - 0.13	0.15 - 0.14
Power Consumption (Rated)		W	15 - 15	17 - 17	15 - 15	17 - 17
Power Factor (Rated)		%	51.5 - 50.2	54.5 - 52.8	51.5 - 50.2	54.5 - 52.8
Temperature Control			Microcomputer Control		Microcomputer Control	
Dimensions (H x W x D)		in. (mm)	23-5/8 x 27-9/16 x 8-1/4 (600 x 700 x 210)		23-5/8 x 27-9/16 x 8-1/4 (600 x 700 x 210)	
Packaged Dimensions (H x W x D)		in. (mm)	27-3/8 x 30-15/16 x 11 (696 x 786 x 280)		27-3/8 x 30-15/16 x 11 (696 x 786 x 280)	
Weight (Mass)		lbs (kg)	31 (14)		31 (14)	
Gross Weight (Gross Mass)		lbs (kg)	38 (17)		38 (17)	
Sound Pressure Level	H / M / L / SL	dB(A)	38 / 32 / 26 / 23	38 / 32 / 26 / 23	39 / 33 / 27 / 24	39 / 33 / 27 / 24
Sound Power Level		dB	—	—	—	—
Heat Insulation			Both Liquid and Gas Pipes		Both Liquid and Gas Pipes	
Piping Connection	Liquid	in. (mm)	ϕ 1/4 (ϕ 6.4)		ϕ 1/4 (ϕ 6.4)	
	Gas	in. (mm)	ϕ 3/8 (ϕ 9.5)		ϕ 3/8 (ϕ 9.5)	
	Drain	in. (mm)	ϕ 13/16 (ϕ 20)		ϕ 13/16 (ϕ 20)	
Drawing No.			3D143142		3D143142	
Note			SL: The quiet fan level of the airflow rate setting		SL: The quiet fan level of the airflow rate setting	

Model			FVXS15VVJU9		FVXS18VVJU9	
			Cooling	Heating	Cooling	Heating
Power Supply		Phase	1 ϕ		1 ϕ	
		Hz, V	60 Hz, 208 - 230 V		60 Hz, 208 - 230 V	
Rated Capacity			15 kBtu/h Class		18 kBtu/h Class	
Front Panel Color			White		White	
Airflow Rates	H	cfm (m ³ /min)	378 (10.7)	417 (11.8)	378 (10.7)	417 (11.8)
	M		325 (9.2)	357 (10.1)	325 (9.2)	357 (10.1)
	L		275 (7.8)	300 (8.5)	275 (7.8)	300 (8.5)
	SL		233 (6.6)	251 (7.1)	233 (6.6)	251 (7.1)
Fan	Type		Turbo Fan		Turbo Fan	
	Motor Output	HP	0.03		0.03	
	Speed	Steps	5 Steps, Quiet, Auto		5 Steps, Quiet, Auto	
Air Direction Control			Right, Left, Horizontal, Downward		Right, Left, Horizontal, Downward	
Air Filter			Removable, Washable		Removable, Washable	
Running Current (Rated)		A	0.19 - 0.17	0.21 - 0.19	0.19 - 0.17	0.21 - 0.19
Power Consumption (Rated)		W	27 - 27	34 - 34	27 - 27	34 - 34
Power Factor (Rated)		%	68.3 - 69.1	77.8 - 77.8	68.3 - 69.1	77.8 - 77.8
Temperature Control			Microcomputer Control		Microcomputer Control	
Dimensions (H x W x D)		in. (mm)	23-5/8 x 27-9/16 x 8-1/4 (600 x 700 x 210)		23-5/8 x 27-9/16 x 8-1/4 (600 x 700 x 210)	
Packaged Dimensions (H x W x D)		in. (mm)	27-3/8 x 30-15/16 x 11 (696 x 786 x 280)		27-3/8 x 30-15/16 x 11 (696 x 786 x 280)	
Weight (Mass)		lbs (kg)	31 (14)		31 (14)	
Gross Weight (Gross Mass)		lbs (kg)	38 (17)		38 (17)	
Sound Pressure Level	H / M / L / SL	dB(A)	44 / 40 / 36 / 32	45 / 40 / 36 / 32	44 / 40 / 36 / 32	45 / 40 / 36 / 32
Sound Power Level		dB	—	—	—	—
Heat Insulation			Both Liquid and Gas Pipes		Both Liquid and Gas Pipes	
Piping Connection	Liquid	in. (mm)	ϕ 1/4 (ϕ 6.4)		ϕ 1/4 (ϕ 6.4)	
	Gas	in. (mm)	ϕ 1/2 (ϕ 12.7)		ϕ 1/2 (ϕ 12.7)	
	Drain	in. (mm)	ϕ 13/16 (ϕ 20)		ϕ 13/16 (ϕ 20)	
Drawing No.			3D143142		3D143029A	
Note			SL: The quiet fan level of the airflow rate setting		SL: The quiet fan level of the airflow rate setting	

Conversion Formulae
kcal/h = kW x 860
Btu/h = kW x 3412
cfm = m ³ /min x 35.3

3.1.3 Duct Concealed Type

Model			CDMQ07WVJU9				FDMQ09WVJU9				
			Cooling		Heating		Cooling		Heating		
Power Supply	Phase		1φ				1φ				
	Hz, V		60 Hz, 208 - 230 V				60 Hz, 208 - 230 V				
Rated Capacity			7 kBtu/h Class				9 kBtu/h Class				
Casing Color			—				—				
Dimensions (H × W × D)		in. (mm)	9-5/8 × 27-9/16 × 31-1/2 (245 × 700 × 800)				9-5/8 × 27-9/16 × 31-1/2 (245 × 700 × 800)				
Coil	Type		Cross Fin Coil				Cross Fin Coil				
	Rows × Stages × Fin per inch		3 × 26 × 18				3 × 26 × 18				
	Face Area	ft ² (m ²)	1-15/16 (0.178)				1-15/16 (0.178)				
Fan	Type		Sirocco Fan				Sirocco Fan				
	Motor Output	HP	0.17				0.17				
	Airflow Rate H / M / L	cfm (m ³ /min)	268 / 251 / 230 (7.6 / 7.1 / 6.5)		268 / 251 / 230 (7.6 / 7.1 / 6.5)		293 / 265 / 233 (8.3 / 7.5 / 6.6)		293 / 265 / 233 (8.3 / 7.5 / 6.6)		
	External Static Pressure ★1	inH ₂ O		0.20 (0.60 - 0.12)				0.20 (0.60 - 0.12)			
		Pa		50 (150 - 30)				50 (150 - 30)			
Sound Pressure Level		dB(A)	30		30		32		32		
Sound Power Level		dB(A)	44		44		46		46		
Air Filter ★2			—				—				
Weight (Mass)		lbs (kg)	64 (29)				64 (29)				
Piping Connection	Liquid	in. (mm)	φ 1/4 (φ 6.4) (Flare)				φ 1/4 (φ 6.4) (Flare)				
	Gas	in. (mm)	φ 3/8 (φ 9.5) (Flare)				φ 3/8 (φ 9.5) (Flare)				
	Drain	in. (mm)	I.D. φ 1 (φ 25) / O.D. φ 1-1/4 (φ 32)				I.D. φ 1 (φ 25) / O.D. φ 1-1/4 (φ 32)				
Remote Controller (Option)	Wired		BRC1E73				BRC1E73				
	Wireless		BRC082A43				BRC082A43				
Drawing No.			3D141740A				3D143150				
Note			★1. External static pressure is changeable in 13 stages by remote controller. ★2. Air filter is not standard accessory, but please mount it in the duct system of the suction side. Select its dust collection efficiency (gravity method) 50% or more.				★1. External static pressure is changeable in 13 stages by remote controller. ★2. Air filter is not standard accessory, but please mount it in the duct system of the suction side. Select its dust collection efficiency (gravity method) 50% or more.				

Model			FDMQ12WVJU9				FDMQ15WVJU9				
			Cooling		Heating		Cooling		Heating		
Power Supply	Phase		1φ				1φ				
	Hz, V		60 Hz, 208 - 230 V				60 Hz, 208 - 230 V				
Rated Capacity			12 kBtu/h Class				15 kBtu/h Class				
Casing Color			—				—				
Dimensions (H × W × D)		in. (mm)	9-5/8 × 27-9/16 × 31-1/2 (245 × 700 × 800)				9-5/8 × 39-3/8 × 31-1/2 (245 × 1,000 × 800)				
Coil	Type		Cross Fin Coil				Cross Fin Coil				
	Rows × Stages × Fin per inch		3 × 26 × 18				2 × 26 × 18				
	Face Area	ft ² (m ²)	1-15/16 (0.178)				3-1/8 (0.288)				
Fan	Type		Sirocco Fan				Sirocco Fan				
	Motor Output	HP	0.17				0.31				
	Airflow Rate H / M / L	cfm (m ³ /min)	371 / 318 / 261 (10.5 / 9.0 / 7.4)		371 / 318 / 261 (10.5 / 9.0 / 7.4)		448 / 399 / 350 (12.7 / 11.3 / 9.9)		448 / 399 / 350 (12.7 / 11.3 / 9.9)		
	External Static Pressure ★1	inH ₂ O		0.20 (0.60 - 0.12)				0.20 (0.60 - 0.20)			
		Pa		50 (150 - 30)				50 (150 - 50)			
Sound Pressure Level		dB(A)	33		33		34		34		
Sound Power Level		dB(A)	47		47		48		48		
Air Filter ★2			—				—				
Weight (Mass)		lbs (kg)	64 (29)				77 (35)				
Piping Connection	Liquid	in. (mm)	φ 1/4 (φ 6.4) (Flare)				φ 1/4 (φ 6.4) (Flare)				
	Gas	in. (mm)	φ 3/8 (φ 9.5) (Flare)				φ 1/2 (φ 12.7) (Flare)				
	Drain	in. (mm)	I.D. φ 1 (φ 25) / O.D. φ 1-1/4 (φ 32)				I.D. φ 1 (φ 25) / O.D. φ 1-1/4 (φ 32)				
Remote Controller (Option)	Wired		BRC1E73				BRC1E73				
	Wireless		BRC082A43				BRC082A43				
Drawing No.			3D143150				3D143151				
Note			★1. External static pressure is changeable in 13 stages by remote controller. ★2. Air filter is not standard accessory, but please mount it in the duct system of the suction side. Select its dust collection efficiency (gravity method) 50% or more.				★1. External static pressure is changeable in 13 stages by remote controller. ★2. Air filter is not standard accessory, but please mount it in the duct system of the suction side. Select its dust collection efficiency (gravity method) 50% or more.				

Conversion Formulae
kcal/h = kW × 860
Btu/h = kW × 3412
cfm = m ³ /min × 35.3

Model			FDMQ18WVJU9		FDMQ24WVJU9	
			Cooling	Heating	Cooling	Heating
Power Supply	Phase		1φ		1φ	
	Hz, V		60 Hz, 208 - 230 V		60 Hz, 208 - 230 V	
Rated Capacity			18 kBtu/h Class		24 kBtu/h Class	
Casing Color			—		—	
Dimensions (H × W × D)		in. (mm)	9-5/8 × 39-3/8 × 31-1/2 (245 × 1,000 × 800)		9-5/8 × 39-3/8 × 31-1/2 (245 × 1,000 × 800)	
Coil	Type		Cross Fin Coil		Cross Fin Coil	
	Rows × Stages × Fin per inch		3 × 26 × 18		3 × 26 × 18	
	Face Area	ft ² (m ²)	3-1/8 (0.288)		3-1/8 (0.288)	
Fan	Type		Sirocco Fan		Sirocco Fan	
	Motor Output	HP	0.31		0.31	
	Airflow Rate H / M / L	cfm (m ³ /min)	614 / 523 / 431 (17.4 / 14.8 / 12.2)	614 / 523 / 431 (17.4 / 14.8 / 12.2)	731 / 621 / 512 (20.7 / 17.6 / 14.5)	731 / 621 / 512 (20.7 / 17.6 / 14.5)
	External Static Pressure ★1	inH ₂ O Pa	0.20 (0.60 - 0.20) 50 (150 - 50)		0.20 (0.60 - 0.20) 50 (150 - 50)	
Sound Pressure Level	dB(A)	35	35	40	40	
Sound Power Level	dB(A)	49	49	54	54	
Air Filter ★2			—		—	
Weight (Mass)		lbs (kg)	82 (37)		82 (37)	
Piping Connection	Liquid	in. (mm)	φ 1/4 (φ 6.4) (Flare)		φ 1/4 (φ 6.4) (Flare)	
	Gas	in. (mm)	φ 1/2 (φ 12.7) (Flare)		φ 5/8 (φ 15.9) (Flare)	
	Drain	in. (mm)	I.D. φ 1 (φ 25) / O.D. φ 1-1/4 (φ 32)		I.D. φ 1 (φ 25) / O.D. φ 1-1/4 (φ 32)	
Remote Controller (Option)	Wired		BRC1E73		BRC1E73	
	Wireless		BRC082A43		BRC082A43	
Drawing No.			3D143151		3D143151	
Note			★1. External static pressure is changeable in 13 stages by remote controller. ★2. Air filter is not standard accessory, but please mount it in the duct system of the suction side. Select its dust collection efficiency (gravity method) 50% or more.		★1. External static pressure is changeable in 13 stages by remote controller. ★2. Air filter is not standard accessory, but please mount it in the duct system of the suction side. Select its dust collection efficiency (gravity method) 50% or more.	

Conversion Formulae
kcal/h = kW × 860
Btu/h = kW × 3412
cfm = m ³ /min × 35.3

3.1.4 Ceiling Cassette Type

Model			FFQ09W2VJU9		FFQ12W2VJU9	
			Cooling	Heating	Cooling	Heating
Power Supply		Phase	1 ϕ		1 ϕ	
		Hz, V	60 Hz, 208 - 230 V		60 Hz, 208 - 230 V	
Rated Capacity			9 kBtu/h Class		12 kBtu/h Class	
Decoration Panel (1)	Model		BYFQ60B3W1		BYFQ60B3W1	
	Color		White		White	
	Dimension (H x W x D)	in. (mm)	2-3/16 x 27-9/16 x 27-9/16 (55 x 700 x 700)		2-3/16 x 27-9/16 x 27-9/16 (55 x 700 x 700)	
	Weight (Mass)	lbs (kg)	6 (2.7)		6 (2.7)	
Decoration Panel (2)	Model		BYFQ60C2W1W / BYFQ60C2W1S		BYFQ60C2W1W / BYFQ60C2W1S	
	Color		White / Silver		White / Silver	
	Dimension (H x W x D)	in. (mm)	1-13/16 x 24-7/16 x 24-7/16 (46 x 620 x 620)		1-13/16 x 24-7/16 x 24-7/16 (46 x 620 x 620)	
	Weight (Mass)	lbs (kg)	6.2 (2.8)		6.2 (2.8)	
Airflow Rates	H	cfm (m ³ /min)	378 (10.7)	399 (11.3)	406 (11.5)	427 (12.1)
	M		339 (9.6)	357 (10.1)	353 (10.0)	371 (10.5)
	L		268 (7.6)	282 (8.0)	268 (7.6)	282 (8.0)
Fan	Type		Turbo Fan		Turbo Fan	
	Motor Output	HP	0.07		0.07	
	Speed	Steps	3 Steps		3 Steps	
Air Direction Control			—		—	
Running Current (Rated)		A	0.23 - 0.21	0.23 - 0.21	0.27 - 0.24	0.27 - 0.24
Power Consumption (Rated)		W	23	23	27	27
Power Factor (Rated)		%	48.1 - 47.6	48.1 - 47.6	48.1 - 48.9	48.1 - 48.9
Temperature Control			Microcomputer Control		Microcomputer Control	
Dimensions (H x W x D)		in. (mm)	10-1/4 x 22-5/8 x 22-5/8 (260 x 575 x 575)		10-1/4 x 22-5/8 x 22-5/8 (260 x 575 x 575)	
Packaged Dimensions (H x W x D)		in. (mm)	11 x 27 x 23-1/2 (280 x 686 x 597)		11 x 27 x 23-1/2 (280 x 686 x 597)	
Weight (Mass)		lbs (kg)	36 (16)		36 (16)	
Gross Weight (Gross Mass)		lbs (kg)	39 (17)		39 (17)	
Sound Pressure Level	H / M / L	dB(A)	38 / 35 / 29	38 / 35 / 29	39 / 36 / 30	39 / 36 / 30
Heat Insulation			Both Liquid and Gas Pipes		Both Liquid and Gas Pipes	
Piping Connection	Liquid	in. (mm)	ϕ 1/4 (ϕ 6.4)		ϕ 1/4 (ϕ 6.4)	
	Gas	in. (mm)	ϕ 3/8 (ϕ 9.5)		ϕ 3/8 (ϕ 9.5)	
	Drain	in. (mm)	VP20 (O.D. ϕ 1-1/32 (ϕ 26))		VP20 (O.D. ϕ 1-1/32 (ϕ 26))	
Drawing No.			3D143143		3D143143	

Conversion Formulae

kcal/h = kW \times 860
 Btu/h = kW \times 3412
 cfm = m³/min \times 35.3

Model			FFQ15W2VJU9		FFQ18W2VJU9	
			Cooling	Heating	Cooling	Heating
Power Supply		Phase	1φ		1φ	
		Hz, V	60 Hz, 208 - 230 V		60 Hz, 208 - 230 V	
Rated Capacity			15 kBtu/h Class		18 kBtu/h Class	
Decoration Panel (1)	Model		BYFQ60B3W1		BYFQ60B3W1	
	Color		White		White	
	Dimension (H × W × D)	in. (mm)	2-3/16 × 27-9/16 × 27-9/16 (55 × 700 × 700)		2-3/16 × 27-9/16 × 27-9/16 (55 × 700 × 700)	
	Weight (Mass)	lbs (kg)	6 (2.7)		6 (2.7)	
Decoration Panel (2)	Model		BYFQ60C2W1W / BYFQ60C2W1S		BYFQ60C2W1W / BYFQ60C2W1S	
	Color		White / Silver		White / Silver	
	Dimension (H × W × D)	in. (mm)	1-13/16 × 24-7/16 × 24-7/16 (46 × 620 × 620)		1-13/16 × 24-7/16 × 24-7/16 (46 × 620 × 620)	
	Weight (Mass)	lbs (kg)	6.2 (2.8)		6.2 (2.8)	
Airflow Rates	H	cfm (m³/min)	420 (11.9)	441 (12.5)	448 (12.7)	498 (14.1)
	M		367 (10.4)	385 (10.9)	378 (10.7)	420 (11.9)
	L		293 (8.3)	307 (8.7)	275 (7.8)	307 (8.7)
	Fan		Turbo Fan		Turbo Fan	
Motor Output		HP	0.07		0.07	
Speed		Steps	3 Steps		3 Steps	
Air Direction Control			—		—	
Running Current (Rated)		A	0.29 - 0.26	0.29 - 0.26	0.52 - 0.47	0.52 - 0.47
Power Consumption (Rated)		W	28		51 - 51	
Power Factor (Rated)		%	46.4 - 46.8		47.2 - 47.2	
Temperature Control			Microcomputer Control		Microcomputer Control	
Dimensions (H × W × D)		in. (mm)	10-1/4 × 22-5/8 × 22-5/8 (260 × 575 × 575)		10-1/4 × 22-5/8 × 22-5/8 (260 × 575 × 575)	
Packaged Dimensions (H × W × D)		in. (mm)	11 × 27 × 23-1/2 (280 × 686 × 597)		11 × 27 × 23-1/2 (280 × 686 × 597)	
Weight (Mass)		lbs (kg)	36 (16)		39.0 (17.5)	
Gross Weight (Gross Mass)		lbs (kg)	39 (17)		42.0 (19.0)	
Sound Pressure Level		H / M / L	40 / 37 / 31	40 / 37 / 31	44 / 40 / 32	44 / 40 / 32
Heat Insulation		Both Liquid and Gas Pipes		Both Liquid and Gas Pipes		
Piping Connection	Liquid	in. (mm)	φ 1/4 (φ 6.4)		φ 1/4 (φ 6.4)	
	Gas	in. (mm)	φ 1/2 (φ 12.7)		φ 1/2 (φ 12.7)	
	Drain	in. (mm)	VP20 (O.D. φ 1-1/32 (φ 26))		VP20 (O.D. φ 1-1/32 (φ 26))	
Drawing No.			3D143144		3D143144	

Conversion Formulae
kcal/h = kW × 860
Btu/h = kW × 3412
cfm = m³/min × 35.3

3.2 Outdoor unit

Model			2MXS18WMVJU9		3MXS24WMVJU9			
			Cooling	Heating	Cooling	Heating		
Power Supply		Phase	1 ϕ		1 ϕ			
		Hz, V	60 Hz, 208 - 230 V		60 Hz, 208 - 230 V			
COP2		W/W	—	4.00 (Non-Ducted) 3.10 (Ducted)	—	4.40 (Non-Ducted) 3.00 (Ducted)		
EER2		Btu/W-h	11.8 (Non-Ducted) 8.8 (Ducted)	—	11.7 (Non-Ducted) 8.5 (Ducted)	—		
SEER2 / HSPF2			16.0 (Non-Ducted) 14.3 (Ducted)	8.7 (Non-Ducted) 7.7 (Ducted)	18.0 (Non-Ducted) 14.9 (Ducted)	9.7 (Non-Ducted) 7.8 (Ducted)		
Casing Color			Ivory White		Ivory White			
Compressor		Type	Hermetically Sealed Swing Type		Hermetically Sealed Swing Type			
		Model	2YC36PXD		2YC63AAXD			
		Motor Output	W	1,100	1,920			
Refrigerant Oil		Model	FVC50K		FVC50K			
		Charge	fl oz (L)	22.0 (0.65)	30.4 (0.9)			
Refrigerant		Type	R410A		R410A			
		Charge	lbs (kg)	3.86 (1.75)	6.17 (2.8)			
Airflow Rates		H	cfm	2,151	2,180	2,094	2,094	
				M	2,151	2,180	2,094	1,979
				L	1,950	1,118	1,979	1,118
		M	m ³ /min	H	60.9	61.7	59.3	59.3
				M	60.9	61.7	59.3	56.0
				L	55.2	31.6	56.0	31.6
Fan		Type	Propeller		Propeller			
		Motor Output	W	55	50			
		Running Current (H / M / L)	A	0.37 / 0.37 / 0.28	0.38 / 0.38 / 0.06	0.34 / 0.34 / 0.29	0.34 / 0.29 / 0.06	
		Power Consumption (H / M / L)	W	75.9 / 75.9 / 57.2	78.9 / 78.9 / 12.6	70.2 / 70.2 / 59.7	70.2 / 59.7 / 12.6	
Starting Current		A	14.0		15.5			
Dimensions (H x W x D)		in. (mm)	28-15/16 x 34-1/4 x 12-5/8 (735 x 870 x 320)		28-15/16 x 34-1/4 x 12-5/8 (735 x 870 x 320)			
Packaged Dimensions (H x W x D)		in. (mm)	31-7/8 x 41-3/8 x 17-1/2 (810 x 1,050 x 444)		31-7/8 x 41-3/8 x 17-1/2 (810 x 1,050 x 444)			
Weight (Mass)		lbs (kg)	126 (57)		140 (63)			
Gross Weight (Gross Mass)		lbs (kg)	136 (62)		150 (68)			
Sound Pressure Level		dB(A)	50	51	52	54		
Piping Connection		Liquid	in. (mm) ϕ 1/4 x 2 (ϕ 6.4 x 2)		ϕ 1/4 x 3 (ϕ 6.4 x 3)			
		Gas	in. (mm) ϕ 3/8 x 1, ϕ 1/2 x 1 (ϕ 9.5 x 1, ϕ 12.7 x 1)		ϕ 3/8 x 1, ϕ 1/2 x 2 (ϕ 9.5 x 1, ϕ 12.7 x 2)			
		Drain	in. (mm) I.D. ϕ 5/8 (ϕ 15.9)		I.D. ϕ 5/8 (ϕ 15.9)			
Heat Insulation			Both Liquid and Gas Pipes		Both Liquid and Gas Pipes			
No. of Wiring Connections			3 for Power Supply, 4 for Interunit Wiring (Including Ground Wiring)		3 for Power Supply, 4 for Interunit Wiring (Including Ground Wiring)			
Max. Interunit Piping Length		ft (m)	164 (50) (for Total of Each Room)		230 (70) (for Total of Each Room)			
		ft (m)	82 (25) (for One Room)		82 (25) (for One Room)			
Amount of Additional Charge		oz/ft (g/m)	0.21 (20) (98-3/8 ft (30 m) or more)		0.21 (20) (131-1/4 ft (40 m) or more)			
Max. Installation Height Difference		ft (m)	49-1/4 (15) (Between Indoor Unit and Outdoor Unit)		49-1/4 (15) (Between Indoor Unit and Outdoor Unit)			
		ft (m)	24-5/8 (7.5) (Between Indoor Units)		24-5/8 (7.5) (Between Indoor Units)			
Conditions Based on		Indoor ; 80°FDB (26.7°CDB) / 67°FWB (19.4°CWB)		Indoor ; 70°FDB (21°CDB) / 60°FWB (15.6°CWB)		Indoor ; 80°FDB (26.7°CDB) / 67°FWB (19.4°CWB)		
		Outdoor ; 95°FDB (35°CDB) / 75°FWB (24°CWB)		Outdoor ; 47°FDB (8.3°CDB) / 43°FWB (6°CWB)		Outdoor ; 95°FDB (35°CDB) / 75°FWB (24°CWB)		
Drawing No.			C: 3D141372		C: 3D141373			

Conversion Formulae
kcal/h = kW x 860
Btu/h = kW x 3412
cfm = m ³ /min x 35.3

Model	4MXS36WMVJU9				5MXS48WVJU9					
	Cooling		Heating		Cooling		Heating			
Power Supply	Phase	1φ				1φ				
	Hz, V	60 Hz, 208 - 230 V				60 Hz, 208 - 230 V				
COP2	W/W	—		4.50 (Non-Ducted) 3.10 (Ducted)		—		3.90 (Non-Ducted) 3.00 (Ducted)		
EER2	Btu/W-h	9.2 (Non-Ducted) 8.0 (Ducted)		—		10.5 (Non-Ducted) 8.2 (Ducted)		—		
SEER2 / HSPF2		18.1 (Non-Ducted) 14.9 (Ducted)		9.4 (Non-Ducted) 7.8 (Ducted)		20.6 (Non-Ducted) 14.5 (Ducted)		9.3 (Non-Ducted) 7.8 (Ducted)		
Casing Color		Ivory White				Ivory White				
Compressor	Type	Hermetically Sealed Swing Type				Hermetically Sealed Swing Type				
	Model	2YC63AAXD				2YC90KXD				
	Motor Output	W		1,920		W		3,000		
Refrigerant Oil	Model	FVC50K				FVC50K				
	Charge	fl oz (L)		30.4 (0.9)		fl oz (L)		51.4 (1.52)		
Refrigerant	Type	R410A				R410A				
	Charge	lbs (kg)		6.17 (2.8)		lbs (kg)		8.60 (3.9)		
Airflow Rates	H	cfm	2,611		2,352		3,684		3,356	
			2,438		2,209		3,029		3,138	
			2,094		1,118		2,756		1,500	
	M	m³/min	73.9		66.6		104.3		95.0	
			69.0		62.5		85.8		88.9	
			59.3		31.6		78.0		42.5	
Fan	Type	Propeller				Propeller				
	Motor Output	W		89		W		126		
	Running Current (H / M / L)	A		0.49 / 0.41 / 0.27		A		0.76 / 0.45 / 0.35		
	Power Consumption (H / M / L)	W		102.1 / 84.6 / 55.8		W		158.5 / 93.3 / 73.2		
Starting Current	A		17.5		A		27.0			
Dimensions (H × W × D)	in. (mm)		28-15/16 × 34-1/4 × 12-5/8 (735 × 870 × 320)		in. (mm)		34-1/4 × 43-5/16 × 18-1/8 (870 × 1,100 × 460)			
Packaged Dimensions (H × W × D)	in. (mm)		31-7/8 × 41-3/8 × 17-1/2 (810 × 1,050 × 444)		in. (mm)		39-15/16 × 46-7/8 × 21-15/16 (1,014 × 1,190 × 558)			
Weight (Mass)	lbs (kg)		144 (65)		lbs (kg)		216 (98)			
Gross Weight (Gross Mass)	lbs (kg)		154 (70)		lbs (kg)		231 (107)			
Sound Pressure Level	dB(A)		54		dB(A)		53			
Piping Connection	Liquid	in. (mm)		φ 1/4 × 4 (φ 6.4 × 4)		in. (mm)		φ 1/4 × 5 (φ 6.4 × 5)		
	Gas	in. (mm)		φ 3/8 × 1, φ 1/2 × 2, φ 5/8 × 1 (φ 9.5 × 1, φ 12.7 × 2, φ 15.9 × 1)		in. (mm)		φ 3/8 × 1, φ 1/2 × 2, φ 5/8 × 2 (φ 9.5 × 1, φ 12.7 × 2, φ 15.9 × 2)		
	Drain	in. (mm)		I.D. φ 5/8 (φ 15.9)		in. (mm)		I.D. φ 1 (φ 25)		
Heat Insulation	Both Liquid and Gas Pipes				Both Liquid and Gas Pipes					
No. of Wiring Connections	3 for Power Supply, 4 for Interunit Wiring (Including Ground Wiring)				3 for Power Supply, 4 for Interunit Wiring (Including Ground Wiring)					
Max. Interunit Piping Length	ft (m)		230 (70) (for Total of Each Room)		ft (m)		262 (80) (for Total of Each Room)			
	ft (m)		82 (25) (for One Room)		ft (m)		98 (30) (for One Room)			
Amount of Additional Charge	oz/ft (g/m)		0.21 (20) (131-1/4 ft (40 m) or more)		oz/ft (g/m)		0.21 (20) (131-1/4 ft (40 m) or more)			
Max. Installation Height Difference	ft (m)		49-1/4 (15) (Between Indoor Unit and Outdoor Unit)		ft (m)		49-1/4 (15) (Between Indoor Unit and Outdoor Unit)			
	ft (m)		24-5/8 (7.5) (Between Indoor Units)		ft (m)		24-5/8 (7.5) (Between Indoor Units)			
Conditions Based on	Indoor ; 80°FDB (26.7°CDB) / 67°FWB (19.4°CWB)		Indoor ; 70°FDB (21°CDB) / 60°FWB (15.6°CWB)		Indoor ; 80°FDB (26.7°CDB) / 67°FWB (19.4°CWB)		Indoor ; 70°FDB (21°CDB) / 60°FWB (15.6°CWB)			
	Outdoor ; 95°FDB (35°CDB) / 75°FWB (24°CWB)		Outdoor ; 47°FDB (8.3°CDB) / 43°FWB (6°CWB)		Outdoor ; 95°FDB (35°CDB) / 75°FWB (24°CWB)		Outdoor ; 47°FDB (8.3°CDB) / 43°FWB (6°CWB)			
Drawing No.	Piping length: 25 ft (7.5 m) C: 3D141377				Piping length: 25 ft (7.5 m) C: 3D141409					

Conversion Formulae
kcal/h = kW × 860
Btu/h = kW × 3412
cfm = m³/min × 35.3

Model	2MXL18WMVJU9				3MXL24WMVJU9						
	Cooling		Heating		Cooling		Heating				
Power Supply	Phase	1 ϕ				1 ϕ					
	Hz, V	60 Hz, 208 - 230 V				60 Hz, 208 - 230 V					
COP2	W/W	—		4.20 (Non-Ducted) 3.12 (Ducted)		—		4.40 (Non-Ducted) 3.00 (Ducted)			
COP2@5°F (-15°C)	W/W	—		2.11 (Non-Ducted) 1.49 (Ducted)		—		2.16 (Non-Ducted) 1.61 (Ducted)			
EER2	Btu/W-h	12.0 (Non-Ducted) 9.0 (Ducted)		—		11.7 (Non-Ducted) 8.5 (Ducted)		—			
SEER2 / HSPF2		16.0 (Non-Ducted) 14.3 (Ducted)		8.7 (Non-Ducted) 7.7 (Ducted)		18.0 (Non-Ducted) 14.9 (Ducted)		9.7 (Non-Ducted) 7.8 (Ducted)			
Casing Color		Ivory White				Ivory White					
Compressor	Type	Hermetically Sealed Swing Type				Hermetically Sealed Swing Type					
	Model	2YC63AAXD				2YC63AAXD					
	Motor Output	W		1,920		1,920					
Refrigerant Oil	Model	FVC50K				FVC50K					
	Charge	fl oz (L)		30.4 (0.9)		30.4 (0.9)					
Refrigerant	Type	R410A				R410A					
	Charge	lbs (kg)		6.17 (2.8)		6.17 (2.8)					
Airflow Rates	H	cfm	2,151		2,180		2,094		2,094		
			2,151		2,180		2,094		1,979		
			1,950		1,118		1,979		1,118		
	M	m ³ /min	60.9		61.7		59.3		59.3		
			60.9		61.7		59.3		56.0		
			55.2		31.6		56.0		31.6		
Fan	Type	Propeller				Propeller					
	Motor Output	W		78		89					
	Running Current (H / M / L)	A		0.29 / 0.29 / 0.22		0.30 / 0.30 / 0.05		0.27 / 0.27 / 0.23		0.27 / 0.23 / 0.05	
	Power Consumption (H / M / L)	W		60.1 / 60.1 / 46.1		62.3 / 62.3 / 11.1		55.8 / 55.8 / 48.0		55.8 / 48.0 / 11.1	
Starting Current	A	15.5				17.5					
Dimensions (H x W x D)	in. (mm)	28-15/16 x 34-1/4 x 12-5/8 (735 x 870 x 320)				28-15/16 x 34-1/4 x 12-5/8 (735 x 870 x 320)					
Packaged Dimensions (H x W x D)	in. (mm)	31-7/8 x 41-3/8 x 17-1/2 (810 x 1,050 x 444)				31-7/8 x 41-3/8 x 17-1/2 (810 x 1,050 x 444)					
Weight (Mass)	lbs (kg)	142 (64)				143 (65)					
Gross Weight (Gross Mass)	lbs (kg)	152 (69)				153 (69)					
Sound Pressure Level	dB(A)	50		51		52		54			
Piping Connection	Liquid	in. (mm) ϕ 1/4 x 2 (ϕ 6.4 x 2)				in. (mm) ϕ 1/4 x 3 (ϕ 6.4 x 3)					
	Gas	in. (mm) ϕ 3/8 x 1, ϕ 1/2 x 1 (ϕ 9.5 x 1, ϕ 12.7 x 1)				in. (mm) ϕ 3/8 x 1, ϕ 1/2 x 2 (ϕ 9.5 x 1, ϕ 12.7 x 2)					
	Drain	in. (mm) I.D. ϕ 5/8 (ϕ 15.9)				in. (mm) I.D. ϕ 5/8 (ϕ 15.9)					
Heat Insulation		Both Liquid and Gas Pipes				Both Liquid and Gas Pipes					
No. of Wiring Connections		3 for Power Supply, 4 for Interunit Wiring (Including Ground Wiring)				3 for Power Supply, 4 for Interunit Wiring (Including Ground Wiring)					
Max. Interunit Piping Length	ft (m)	164 (50) (for Total of Each Room)				230 (70) (for Total of Each Room)					
	ft (m)	82 (25) (for One Room)				82 (25) (for One Room)					
Amount of Additional Charge	oz/ft (g/m)	0.21 (20) (98-3/8 ft (30 m) or more)				0.21 (20) (131-1/4 ft (40 m) or more)					
Max. Installation Height Difference	ft (m)	49-1/4 (15) (Between Indoor Unit and Outdoor Unit)				49-1/4 (15) (Between Indoor Unit and Outdoor Unit)					
	ft (m)	24-5/8 (7.5) (Between Indoor Units)				24-5/8 (7.5) (Between Indoor Units)					
Conditions Based on		Indoor ; 80°FDB (26.7°CDB) / 67°FWB (19.4°CWB)		Indoor ; 70°FDB (21°CDB) / 60°FWB (15.6°CWB)		Indoor ; 80°FDB (26.7°CDB) / 67°FWB (19.4°CWB)		Indoor ; 70°FDB (21°CDB) / 60°FWB (15.6°CWB)			
		Outdoor ; 95°FDB (35°CDB) / 75°FWB (24°CWB)		Outdoor ; 47°FDB (8.3°CDB) / 43°FWB (6°CWB)		Outdoor ; 95°FDB (35°CDB) / 75°FWB (24°CWB)		Outdoor ; 47°FDB (8.3°CDB) / 43°FWB (6°CWB)			
		Piping length: 25 ft (7.5 m)				Piping length: 25 ft (7.5 m)					
Drawing No.		C: 3D141378				C: 3D141381					

Conversion Formulae
kcal/h = kW x 860
Btu/h = kW x 3412
cfm = m ³ /min x 35.3

Model			4MXL36WVJU9	
			Cooling	Heating
Power Supply	Phase		1 ϕ	
	Hz, V		60 Hz, 208 - 230 V	
COP2	W/W		—	4.26 (Non-Ducted) 3.30 (Ducted)
COP2@5°F (-15°C)	W/W		—	2.00 (Non-Ducted) 1.75 (Ducted)
EER2	Btu/W-h		11.7 (Non-Ducted) 9.3 (Ducted)	—
SEER2 / HSPF2			20.0 (Non-Ducted) 15.9 (Ducted)	9.0 (Non-Ducted) 8.1 (Ducted)
Casing Color			Ivory White	
Compressor	Type		Hermetically Sealed Swing Type	
	Model		2YC90KXD	
	Motor Output	W	3,000	
Refrigerant Oil	Model		FVC50K	
	Charge	fl oz (L)	51.4 (1.52)	
Refrigerant	Type		R410A	
	Charge	lbs (kg)	8.60 (3.9)	
Airflow Rates	H	cfm	3,684	3,356
	M		3,029	3,138
	L		2,756	1,500
	H	m ³ /min	104.3	95.0
	M		85.8	88.9
	L		78.0	42.5
Fan	Type		Propeller	
	Motor Output	W	126	
	Running Current (H / M / L)	A	0.76 / 0.45 / 0.35	0.59 / 0.49 / 0.17
	Power Consumption (H / M / L)	W	158.5 / 93.3 / 73.2	122.9 / 102.5 / 34.9
Starting Current	A	27.0		
Dimensions (H x W x D)	in. (mm)	34-1/4 x 43-5/16 x 18-1/8 (870 x 1,100 x 460)		
Packaged Dimensions (H x W x D)	in. (mm)	39-15/16 x 46-7/8 x 21-15/16 (1,014 x 1,190 x 558)		
Weight (Mass)	lbs (kg)	214 (97)		
Gross Weight (Gross Mass)	lbs (kg)	229 (104)		
Sound Pressure Level	dB(A)	53	55	
Piping Connection	Liquid	in. (mm)	ϕ 1/4 x 4 (ϕ 6.4 x 4)	
	Gas	in. (mm)	ϕ 3/8 x 1, ϕ 1/2 x 2, ϕ 5/8 x 1 (ϕ 9.5 x 1, ϕ 12.7 x 2, ϕ 15.9 x 1)	
	Drain	in. (mm)	I.D. ϕ 1 (ϕ 25)	
Heat Insulation		Both Liquid and Gas Pipes		
No. of Wiring Connections		3 for Power Supply, 4 for Interunit Wiring (Including Ground Wiring)		
Max. Interunit Piping Length	ft (m)	230 (70) (for Total of Each Room)		
	ft (m)	98 (30) (for One Room)		
Amount of Additional Charge	oz/ft (g/m)	0.21 (20) (131-1/4 ft (40 m) or more)		
Max. Installation Height Difference	ft (m)	49-1/4 (15) (Between Indoor Unit and Outdoor Unit)		
	ft (m)	24-5/8 (7.5) (Between Indoor Units)		
Conditions Based on		Indoor ; 80°FDB (26.7°CDB) / 67°FWB (19.4°CWB) Outdoor ; 95°FDB (35°CDB) / 75°FWB (24°CWB)	Indoor ; 70°FDB (21°CDB) / 60°FWB (15.6°CWB) Outdoor ; 47°FDB (8.3°CDB) / 43°FWB (6°CWB)	
Drawing No.		Piping length: 25 ft (7.5 m) C: 3D141407		

Conversion Formulae
kcal/h = kW x 860
Btu/h = kW x 3412
cfm = m ³ /min x 35.3

Model			2MXLH18WVJU9				3MXLH24WVJU9			
			Cooling		Heating		Cooling		Heating	
Power Supply			1φ				1φ			
Phase			60 Hz, 208 - 230 V				60 Hz, 208 - 230 V			
Hz, V										
COP2			—		4.20 (Non-Ducted) 3.12 (Ducted)		—		4.40 (Non-Ducted) 3.00 (Ducted)	
COP2@5°F (-15°C)			—		2.00 (Non-Ducted) 1.39 (Ducted)		—		2.03 (Non-Ducted) 1.53 (Ducted)	
EER2			12.0 (Non-Ducted) 9.0 (Ducted)		—		11.7 (Non-Ducted) 8.5 (Ducted)		—	
SEER2 / HSPF2			16.0 (Non-Ducted) 14.3 (Ducted)		8.5 (Non-Ducted) 7.5 (Ducted)		18.0 (Non-Ducted) 14.9 (Ducted)		9.3 (Non-Ducted) 7.5 (Ducted)	
Casing Color			Ivory White				Ivory White			
Compressor			Hermetically Sealed Swing Type				Hermetically Sealed Swing Type			
Type										
Model			2YC63AAXD				2YC63AAXD			
Motor Output			W		1,920		W		1,920	
Refrigerant Oil			FVC50K				FVC50K			
Model										
Charge			fl oz (L)		30.4 (0.9)		fl oz (L)		30.4 (0.9)	
Refrigerant			R410A				R410A			
Type										
Charge			lbs (kg)		6.17 (2.8)		lbs (kg)		6.17 (2.8)	
Airflow Rates			cfm		2,151		cfm		2,094	
H					2,180				2,094	
M					2,180				1,979	
L					1,118				1,118	
m³/min			60.9		61.7		59.3		59.3	
H					61.7				56.0	
M					61.7				56.0	
L					31.6				31.6	
Fan			Propeller				Propeller			
Type										
Motor Output			W		78		W		89	
Running Current (H / M / L)			A		0.29 / 0.29 / 0.22		A		0.27 / 0.27 / 0.23	
Power Consumption (H / M / L)			W		60.1 / 60.1 / 46.1		W		55.8 / 55.8 / 48.0	
Starting Current			A		15.5		A		17.5	
Dimensions (H × W × D)			in. (mm)				in. (mm)			
28-15/16 × 34-1/4 × 12-5/8 (735 × 870 × 320)							28-15/16 × 34-1/4 × 12-5/8 (735 × 870 × 320)			
Packaged Dimensions (H × W × D)			in. (mm)				in. (mm)			
31-7/8 × 41-3/8 × 17-1/2 (810 × 1,050 × 444)							31-7/8 × 41-3/8 × 17-1/2 (810 × 1,050 × 444)			
Weight (Mass)			lbs (kg)		143 (65)		lbs (kg)		144 (65)	
Gross Weight (Gross Mass)			lbs (kg)		153 (70)		lbs (kg)		154 (70)	
Sound Pressure Level			dB(A)		50		dB(A)		54	
Piping Connection			φ 1/4 × 2 (φ 6.4 × 2)				φ 1/4 × 3 (φ 6.4 × 3)			
Liquid			in. (mm)				in. (mm)			
Gas			in. (mm)		φ 3/8 × 1, φ 1/2 × 1 (φ 9.5 × 1, φ 12.7 × 1)		in. (mm)		φ 3/8 × 1, φ 1/2 × 2 (φ 9.5 × 1, φ 12.7 × 2)	
Drain			in. (mm)		I.D. φ 5/8 (φ 15.9)		in. (mm)		I.D. φ 5/8 (φ 15.9)	
Heat Insulation			Both Liquid and Gas Pipes				Both Liquid and Gas Pipes			
No. of Wiring Connections			3 for Power Supply, 4 for Interunit Wiring (Including Ground Wiring)				3 for Power Supply, 4 for Interunit Wiring (Including Ground Wiring)			
Max. Interunit Piping Length			ft (m)		164 (50) (for Total of Each Room)		ft (m)		230 (70) (for Total of Each Room)	
			ft (m)		82 (25) (for One Room)		ft (m)		82 (25) (for One Room)	
Amount of Additional Charge			oz/ft (g/m)		0.21 (20) (98-3/8 ft (30 m) or more)		oz/ft (g/m)		0.21 (20) (131-1/4 ft (40 m) or more)	
Max. Installation Height Difference			ft (m)		49-1/4 (15) (Between Indoor Unit and Outdoor Unit)		ft (m)		49-1/4 (15) (Between Indoor Unit and Outdoor Unit)	
			ft (m)		24-5/8 (7.5) (Between Indoor Units)		ft (m)		24-5/8 (7.5) (Between Indoor Units)	
Conditions Based on			Indoor ; 80°FDB (26.7°CWB) / 67°FWB (19.4°CWB)		Indoor ; 70°FDB (21°CWB) / 60°FWB (15.6°CWB)		Indoor ; 80°FDB (26.7°CWB) / 67°FWB (19.4°CWB)		Indoor ; 70°FDB (21°CWB) / 60°FWB (15.6°CWB)	
			Outdoor ; 95°FDB (35°CWB) / 75°FWB (24°CWB)		Outdoor ; 47°FDB (8.3°CWB) / 43°FWB (6°CWB)		Outdoor ; 95°FDB (35°CWB) / 75°FWB (24°CWB)		Outdoor ; 47°FDB (8.3°CWB) / 43°FWB (6°CWB)	
Drawing No.			Piping length: 25 ft (7.5 m) C: 3D141379				Piping length: 25 ft (7.5 m) C: 3D141382			

Conversion Formulae
kcal/h = kW × 860
Btu/h = kW × 3412
cfm = m³/min × 35.3

Model			4MXLH36WVJU9			
			Cooling		Heating	
Power Supply		Phase	1 ϕ			
		Hz, V	60 Hz, 208 - 230 V			
COP2		W/W	—		4.26 (Non-Ducted) 3.30 (Ducted)	
COP2@5°F (-15°C)		W/W	—		2.00 (Non-Ducted) 1.7 (Ducted)	
EER2		Btu/W-h	11.7 (Non-Ducted) 9.3 (Ducted)		—	
SEER2 / HSPF2			20.0 (Non-Ducted) 15.9 (Ducted)		8.8 (Non-Ducted) 7.8 (Ducted)	
Casing Color			Ivory White			
Compressor		Type	Hermetically Sealed Swing Type			
		Model	2YC90KXD			
		Motor Output	W		3,000	
Refrigerant Oil		Model	FVC50K			
		Charge	fl oz (L)		51.4 (1.52)	
Refrigerant		Type	R410A			
		Charge	lbs (kg)		8.60 (3.9)	
Airflow Rates		H	cfm	3,684		3,356
				3,029		3,138
				2,756		1,500
		M	m ³ /min	104.3		95.0
				85.8		88.9
				78.0		42.5
Fan		Type	Propeller			
		Motor Output	W		126	
		Running Current (H / M / L)	A		0.76 / 0.45 / 0.35	0.59 / 0.49 / 0.17
		Power Consumption (H / M / L)	W		158.5 / 93.3 / 73.2	122.9 / 102.5 / 34.9
Starting Current		A	27.0			
Dimensions (H × W × D)		in. (mm)	34-1/4 × 43-5/16 × 18-1/8 (870 × 1,100 × 460)			
Packaged Dimensions (H × W × D)		in. (mm)	39-15/16 × 46-7/8 × 21-15/16 (1,014 × 1,190 × 558)			
Weight (Mass)		lbs (kg)	216 (98)			
Gross Weight (Gross Mass)		lbs (kg)	230 (104)			
Sound Pressure Level		dB(A)	53		55	
Piping Connection		Liquid	in. (mm) ϕ 1/4 × 4 (ϕ 6.4 × 4)			
		Gas	in. (mm) ϕ 3/8 × 1, ϕ 1/2 × 2, ϕ 5/8 × 1 (ϕ 9.5 × 1, ϕ 12.7 × 2, ϕ 15.9 × 1)			
		Drain	in. (mm) I.D. ϕ 1 (ϕ 25)			
Heat Insulation			Both Liquid and Gas Pipes			
No. of Wiring Connections			3 for Power Supply, 4 for Interunit Wiring (Including Ground Wiring)			
Max. Interunit Piping Length		ft (m)	230 (70) (for Total of Each Room)			
		ft (m)	98 (30) (for One Room)			
Amount of Additional Charge		oz/ft (g/m)	0.21 (20) (131-1/4 ft (40 m) or more)			
Max. Installation Height Difference		ft (m)	49-1/4 (15) (Between Indoor Unit and Outdoor Unit)			
		ft (m)	24-5/8 (7.5) (Between Indoor Units)			
Conditions Based on			Indoor ; 80°FDB (26.7°CDB) / 67°FWB (19.4°CWB) Outdoor ; 95°FDB (35°CDB) / 75°FWB (24°CWB)		Indoor ; 70°FDB (21°CDB) / 60°FWB (15.6°CWB) Outdoor ; 47°FDB (8.3°CDB) / 43°FWB (6°CWB)	
Drawing No.			Piping length: 25 ft (7.5 m) C: 3D141408			

Conversion Formulae
kcal/h = kW × 860
Btu/h = kW × 3412
cfm = m ³ /min × 35.3

3.3 Combination Capacity

Refer to Engineering Data books below for the Combination Capacity.

Type	Model Name	Reference
Standard type	2MXS18WMVJU9 3MXS24WMVJU9 4MXS36WMVJU9 5MXS48WVJU9	EDUS122206
Cold climate type	2MXL18WMVJU9 3MXL24WMVJU9 4MXL36WVJU9 2MXLH18WVJU9 3MXLH24WVJU9 4MXLH36WVJU9	EDUS122207

4 Dimensions

4.1 Indoor unit

CTXS07WVJU9, FTXS09/12WVJU9

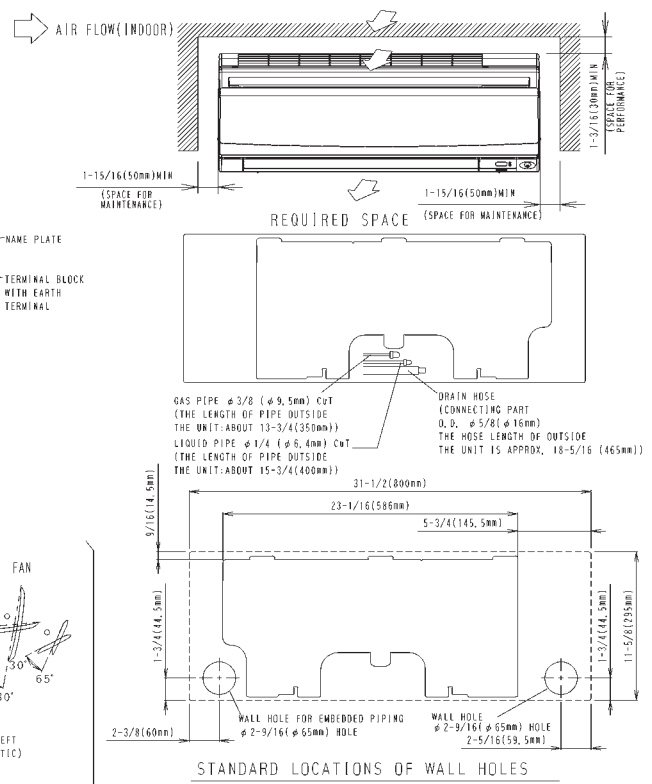
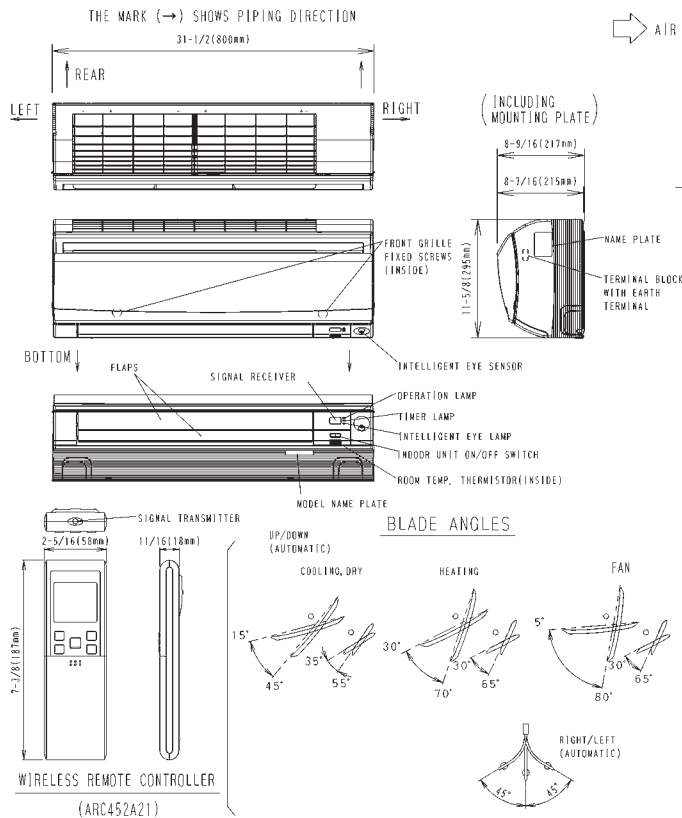

3D074094B

FTXS15/18WVJU9

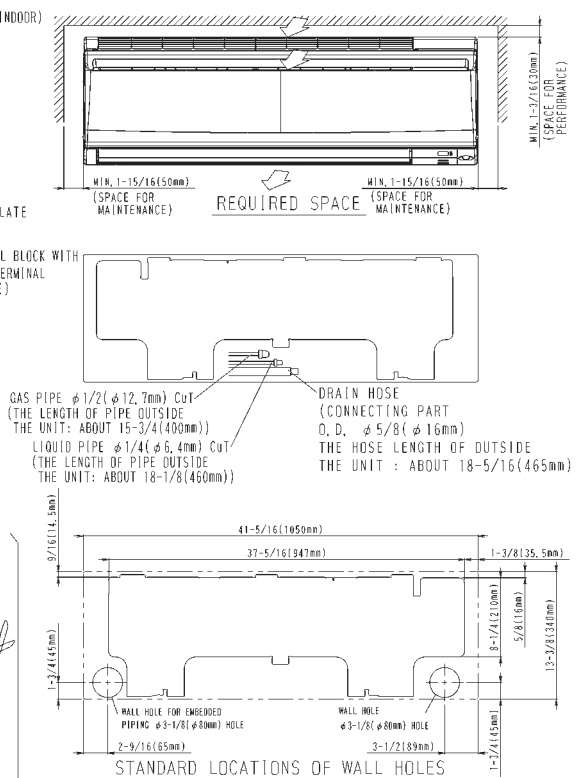
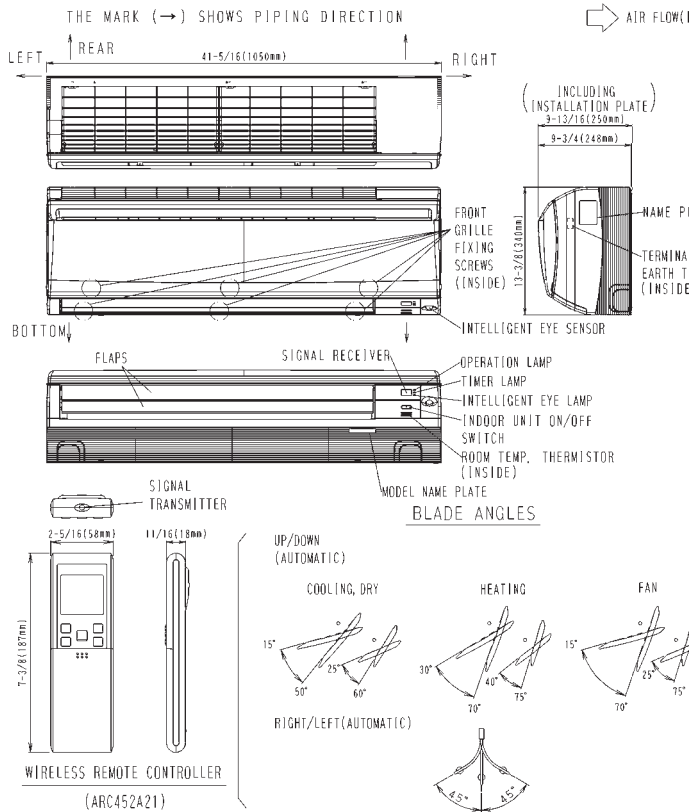

3D074024B

FTXS24WVJU9

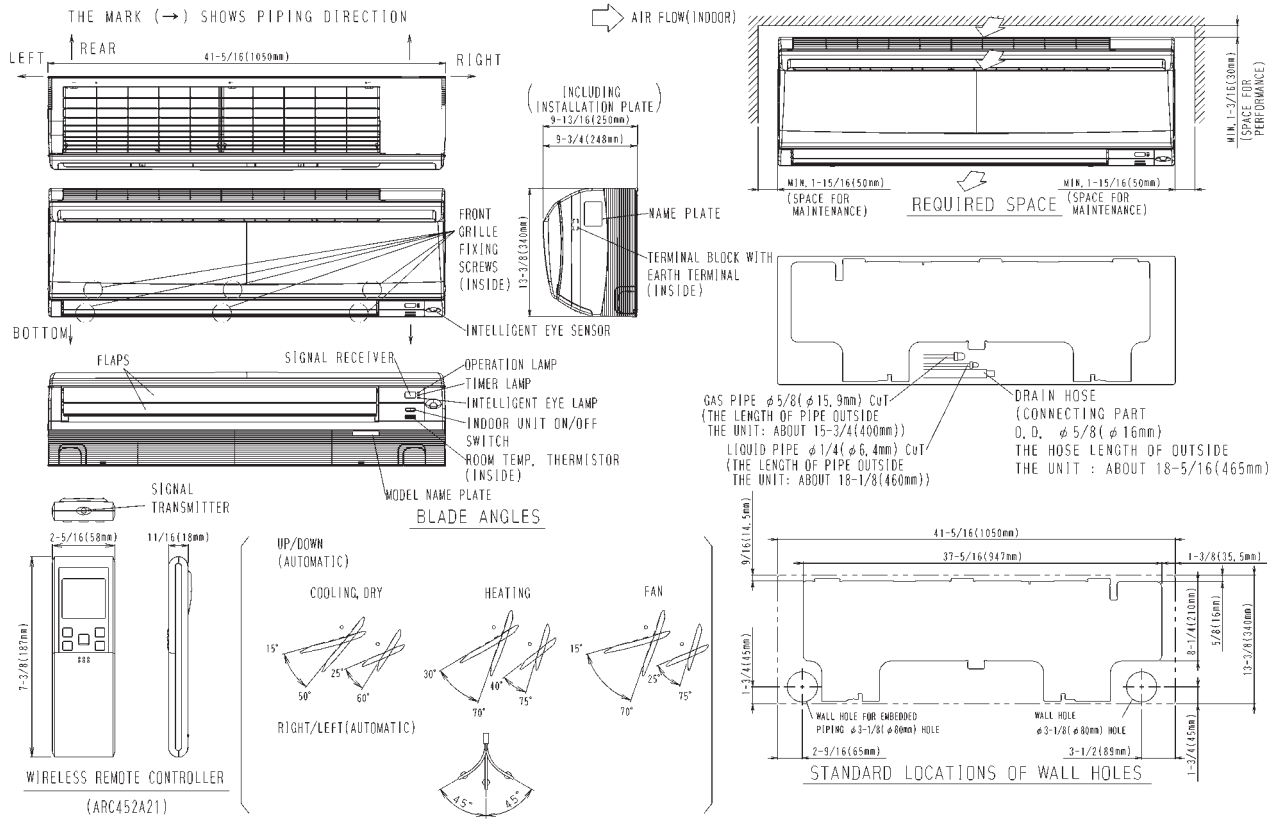

3D073962B

FTXR09/12WVJUW(S)9

NOTE1, THE MARK (→) SHOWS PIPING DIRECTION.

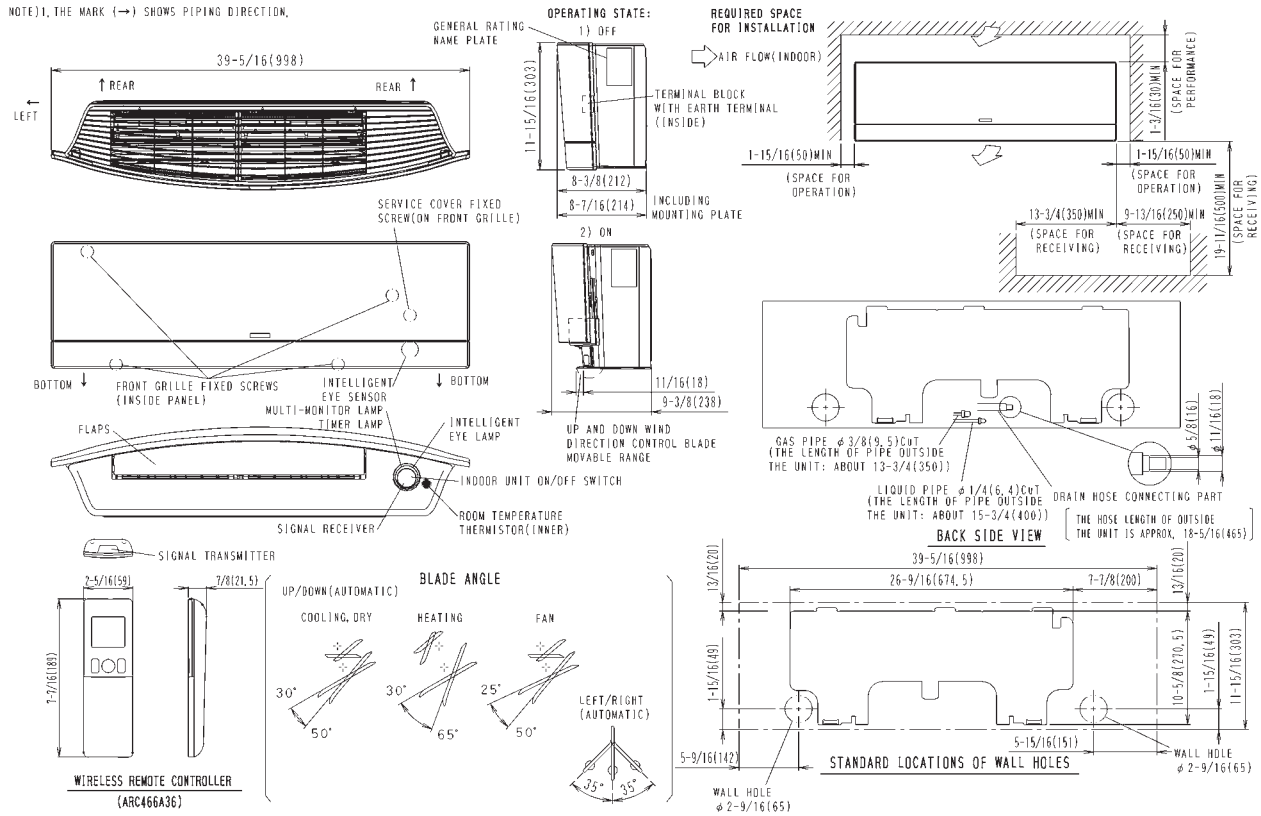

3D105568B

FTXR18WVJUW(S)9

NOTE1, THE MARK (→) SHOWS PIPING DIRECTION.

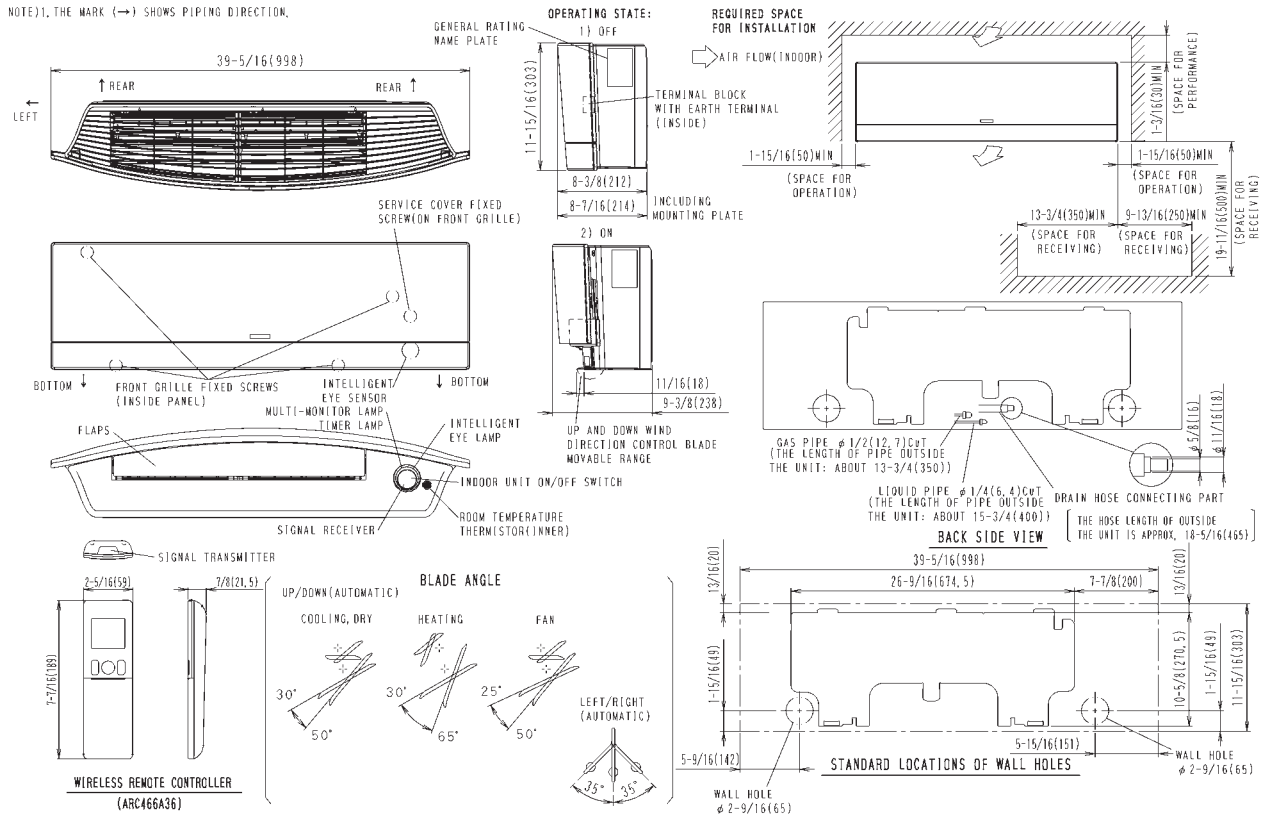

3D105569B

FVXS09/12WVJU9

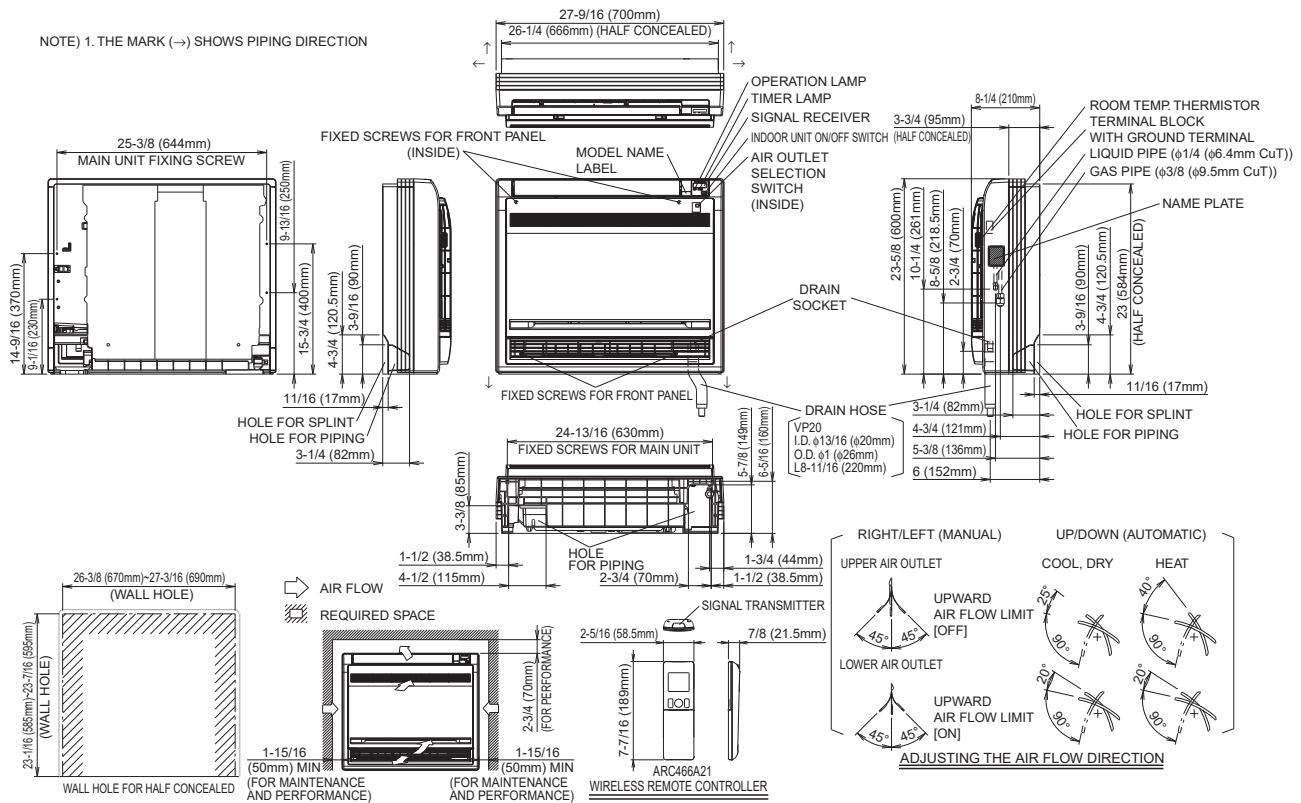

3D091758A

FVXS15/18WVJU9

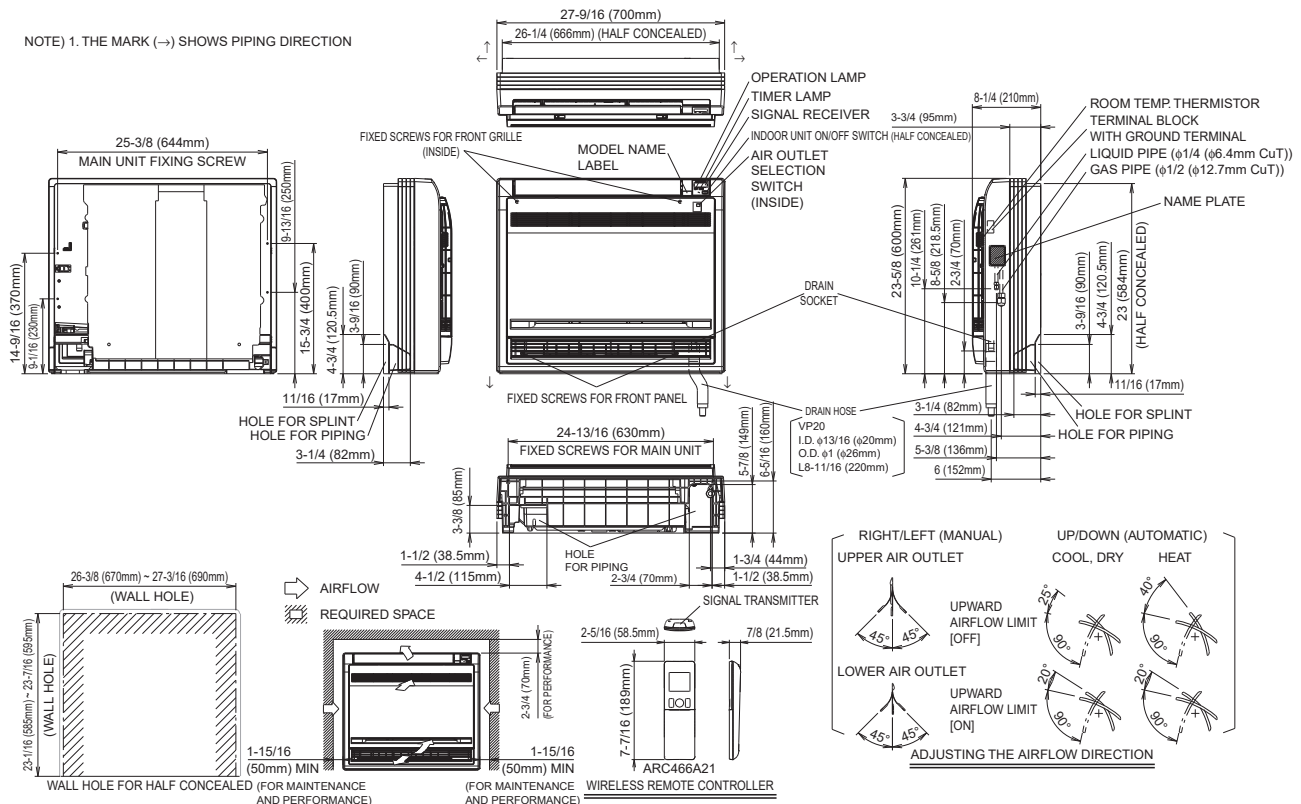

C: 3D091774B

CDMQ07WVJU9, FDMQ09/12WVJU9

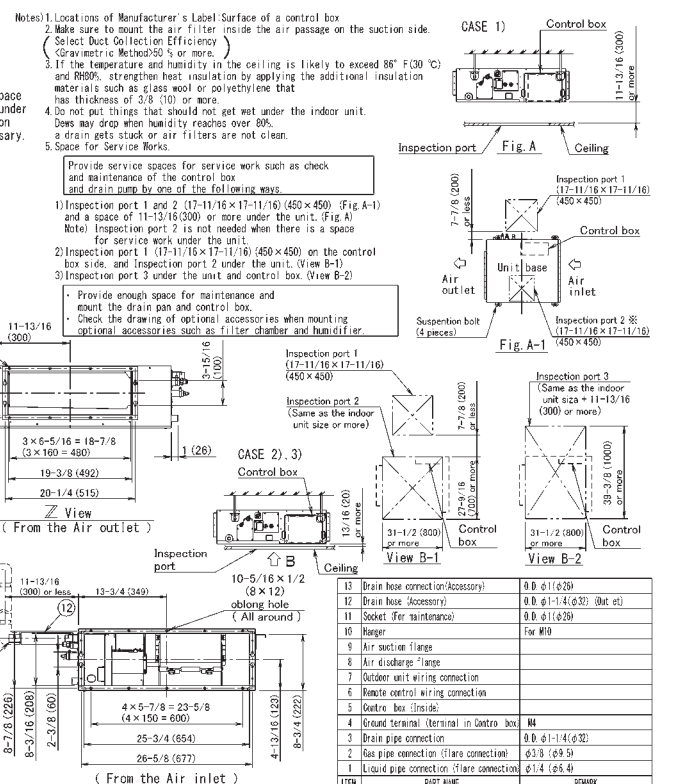
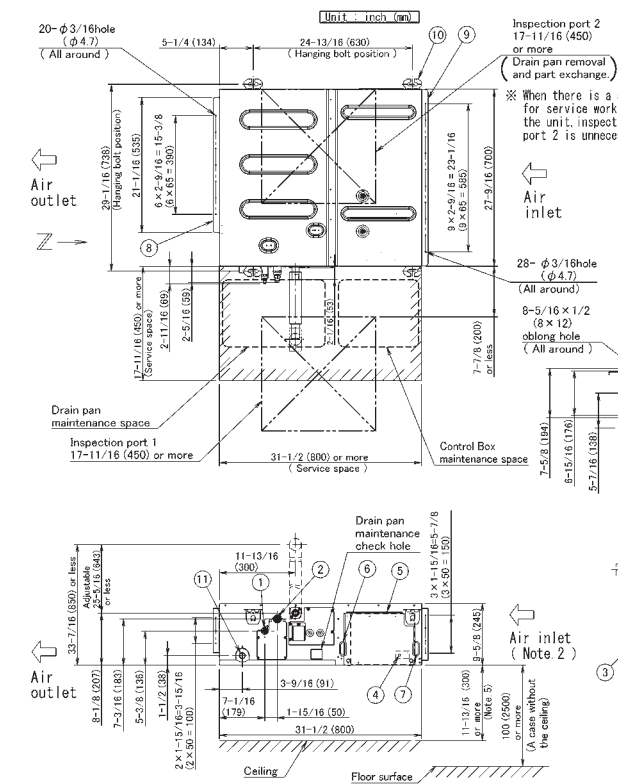

FDMQ15/18/24WVJU9

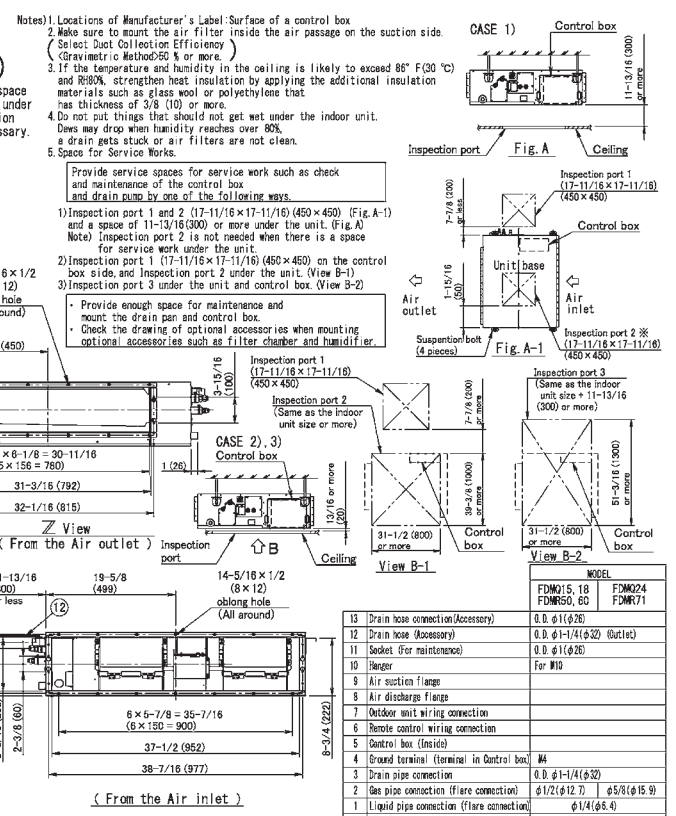
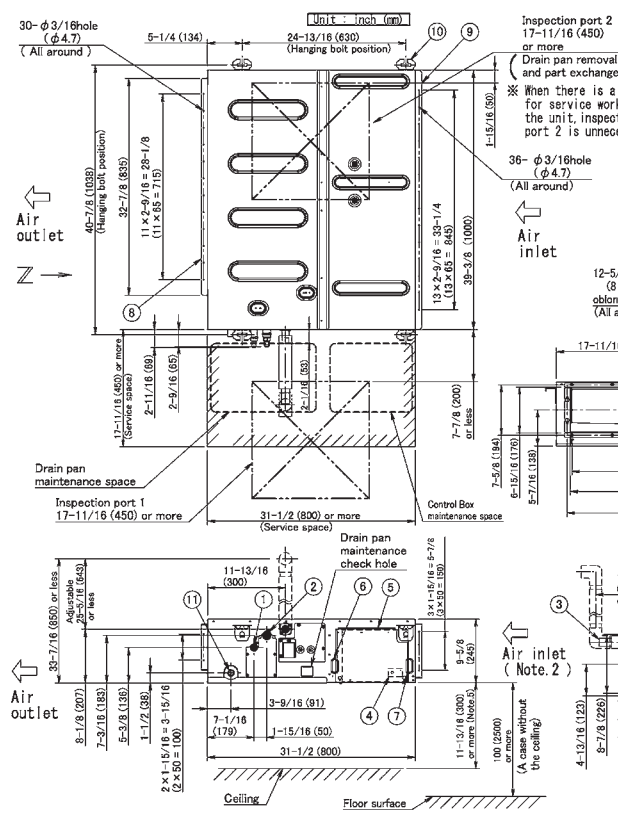

ITEM	PART NAME	REMARK
13	Drain hose connection (Accessory)	0.0 ϕ 1 ($\phi 26$)
12	Drain hose (Accessory)	0.0 ϕ 1-1/4 ($\phi 32$) (Outlet)
11	Socket (for maintenance)	0.0 ϕ 1 ($\phi 26$)
10	Hanger	For M10
9	Air suction flange	
8	Air discharge flange	
7	Outdoor unit wiring connection	
6	Remote control wiring connection	
5	Control box (Inside)	
4	Ground terminal (terminal in Control box)	#4
3	Drain pipe connection	0.0 ϕ 1-1/4 ($\phi 32$)
2	Gas pipe connection (Flare connection)	ϕ 1/2 ($\phi 12.7$) ϕ 5/8 ($\phi 15.9$)
1	Liquid pipe connection (Flare connection)	ϕ 1/4 ($\phi 6.4$)

MODEL	MODEL
FDMQ15, 18, FDMR50, 60	FDMQ24, FDMR71

3D112918C

3D112919B

FFQ09/12/15/18W2VJU9 with BYFQ60B3W1 (Decoration Panel)

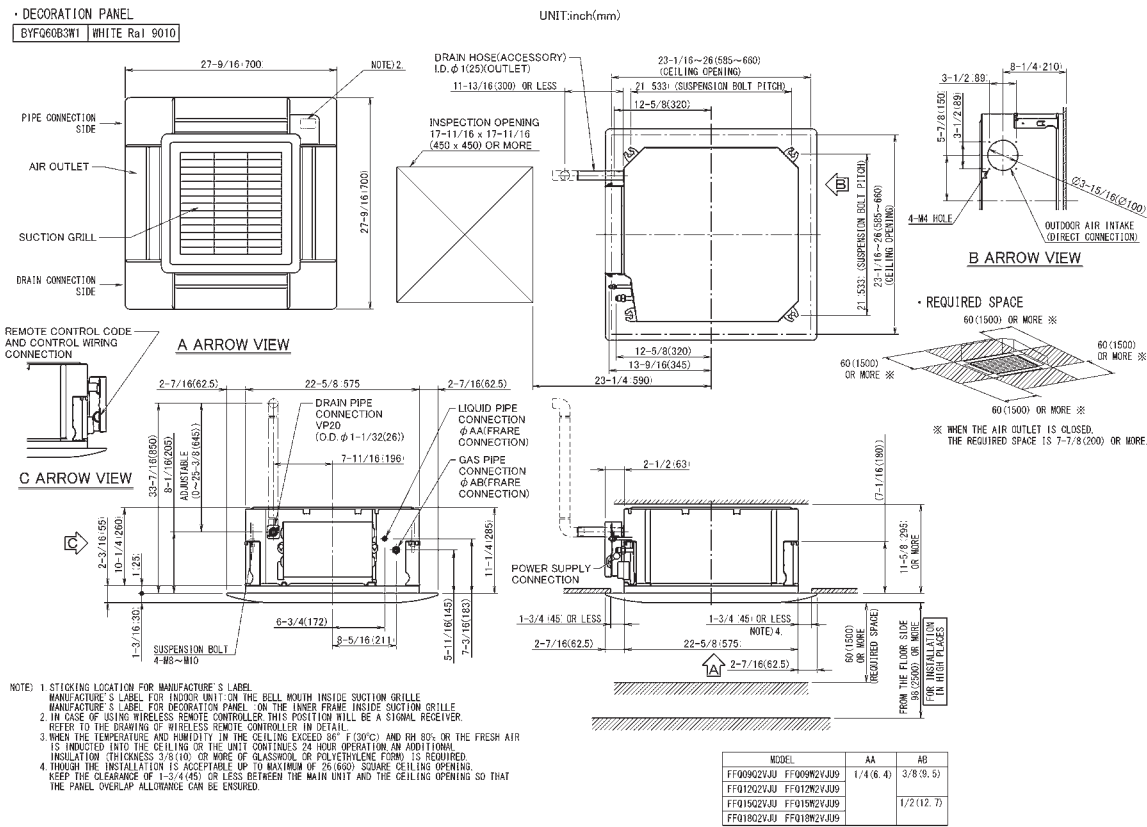

3D106040

FFQ09/12/15/18W2VJU9 with BYFQ60C2W1W(S) (Decoration Panel)

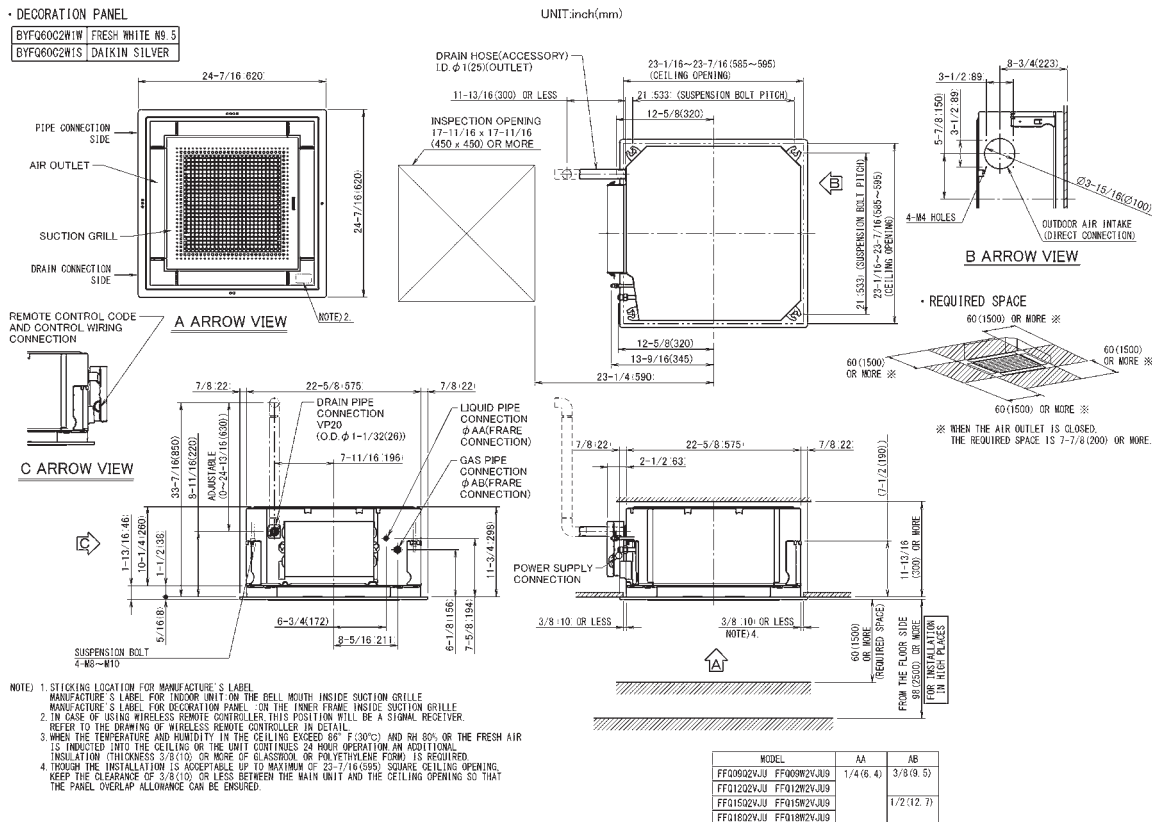

3D106039

BRC1E73 — Wired Remote Controller (Option) —

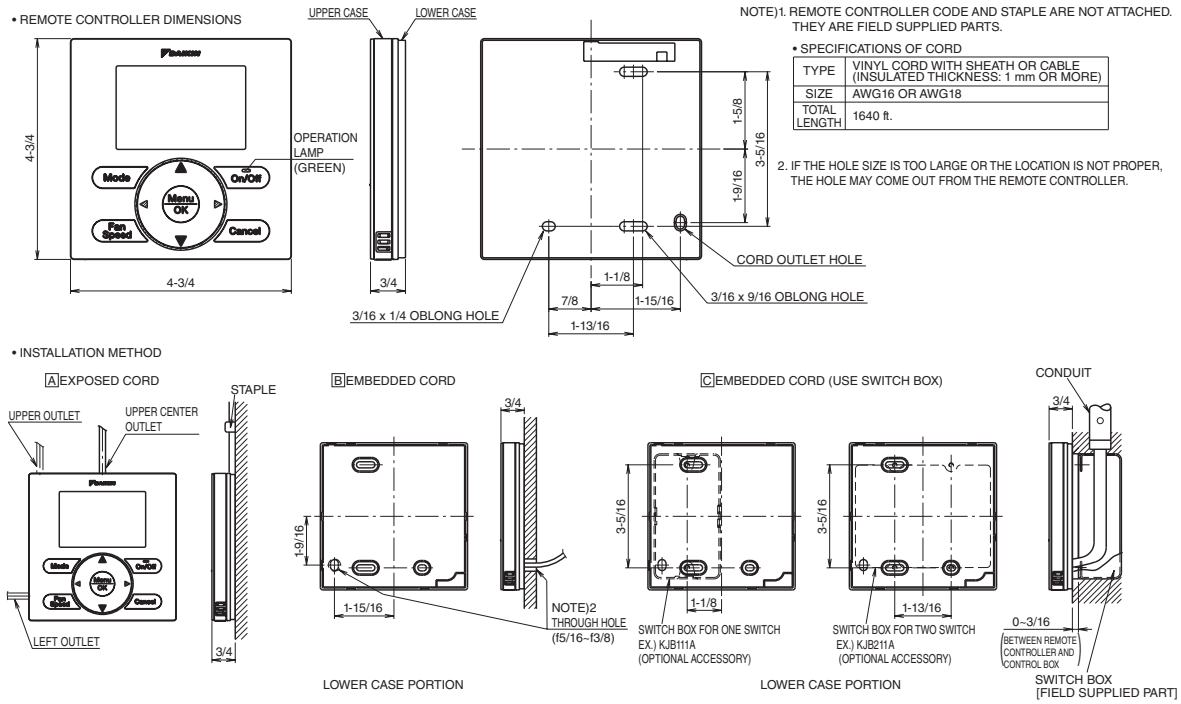

3D091305A

BRC082A43 — Wireless Remote Controller (Option) —

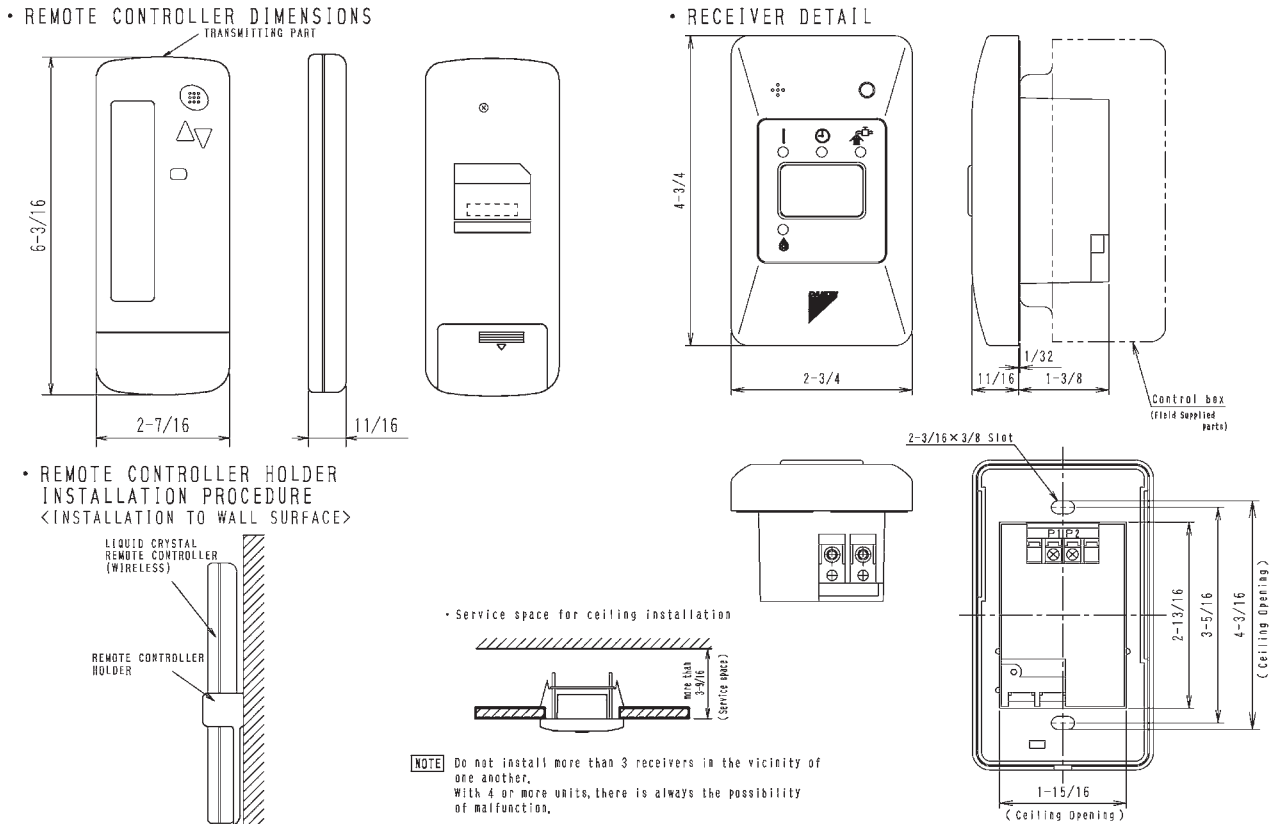

3D049611A

BRC082A41W — Wireless Remote Controller (Option) —

• REMOTE CONTROLLER DIMENSIONS

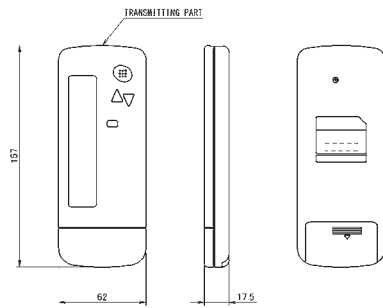

• RECEIVER INSTALLATION PROCEDURE

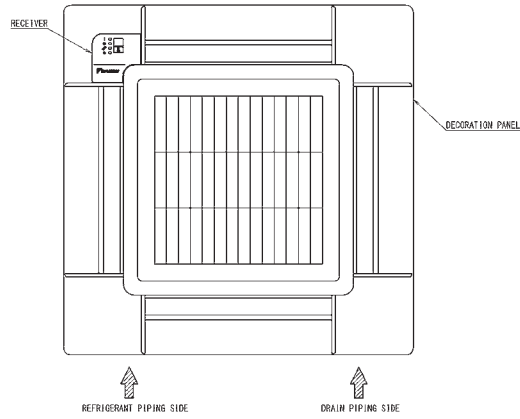

• REMOTE CONTROLLER HOLDER
INSTALLATION PROCEDURE
<INSTALLATION TO WALL SURFACE>

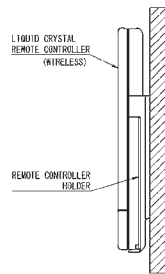

• RECEIVER DETAIL

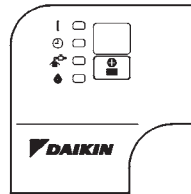

3D082556A

BRC082A42W(S) — Wireless Remote Controller (Option) —

• REMOTE CONTROLLER DIMENSIONS

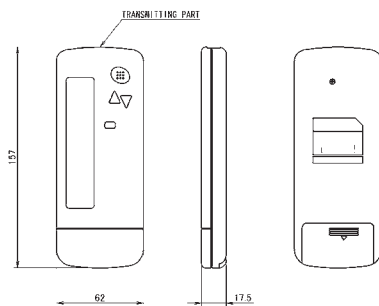

• RECEIVER INSTALLATION PROCEDURE

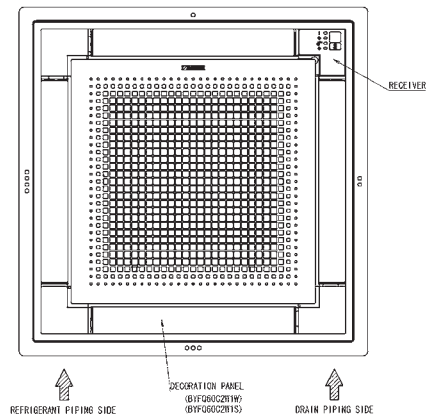

• REMOTE CONTROLLER HOLDER
INSTALLATION PROCEDURE
<INSTALLATION TO WALL SURFACE>

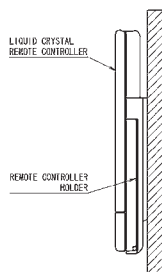

• RECEIVER DETAIL

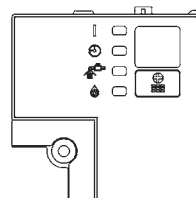

3D082024

4.2 Outdoor unit 2MXS18WMVJU9, 2MXL18WMVJU9, 2MXLH18WVJU9

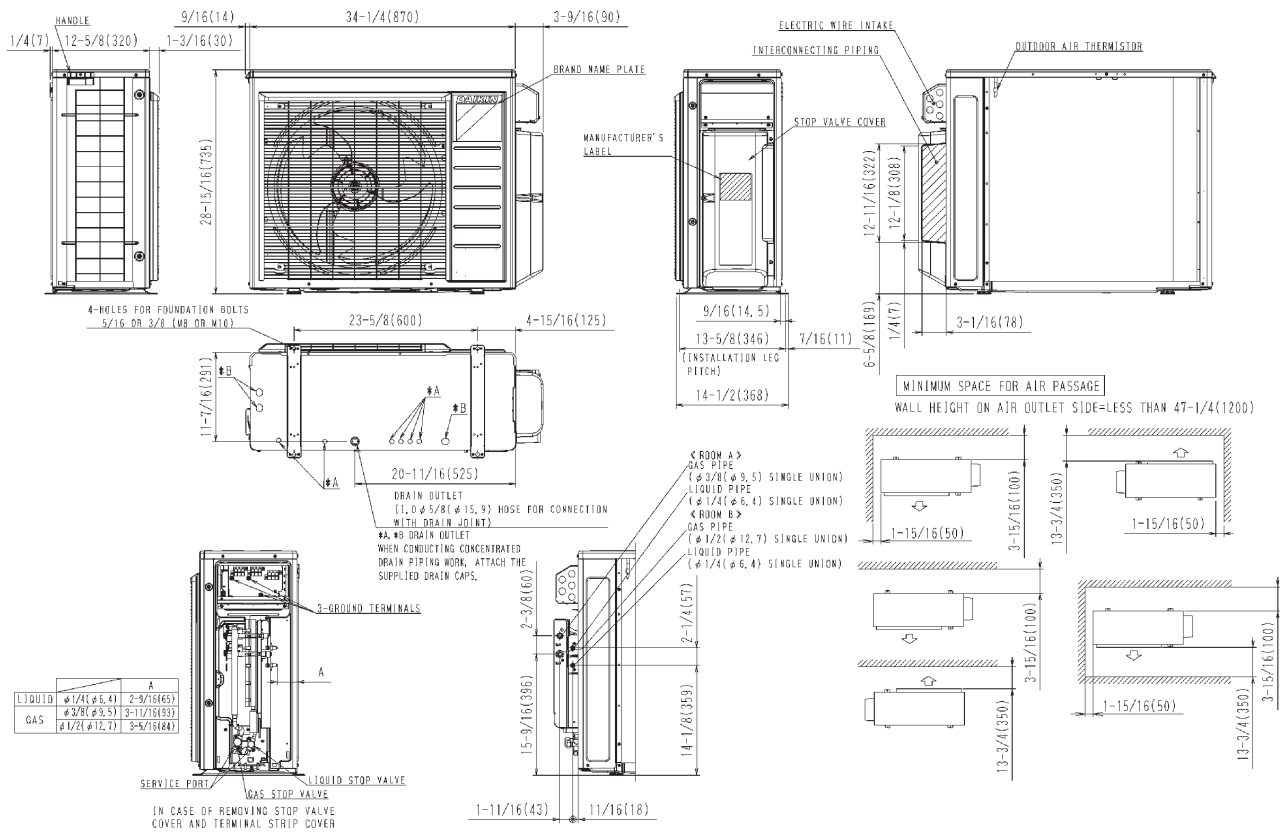

3D093197B

3MXS24WMVJU9, 3MXL24WMVJU9, 3MXLH24WVJU9

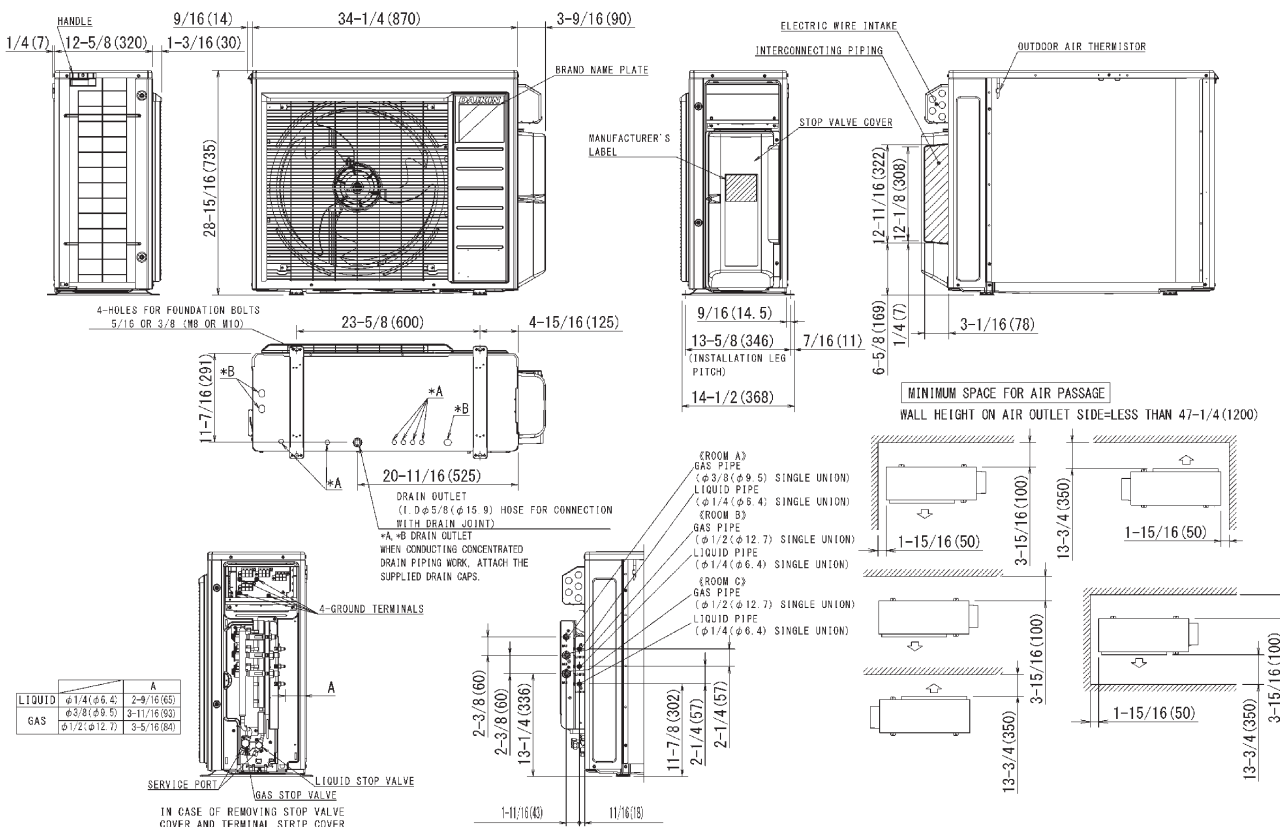

3D093198C

4MXS36WMVJU9

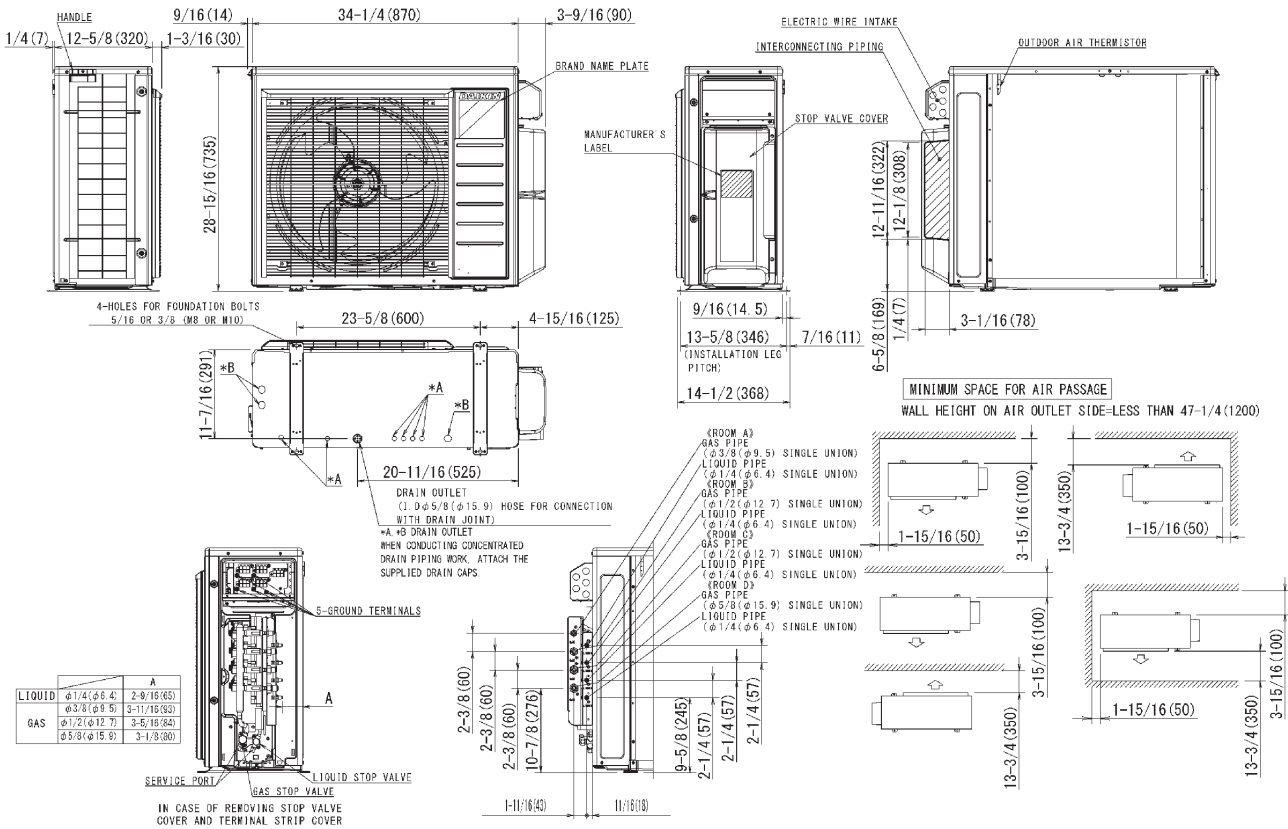

3D093199C

5MXS48WVJU9

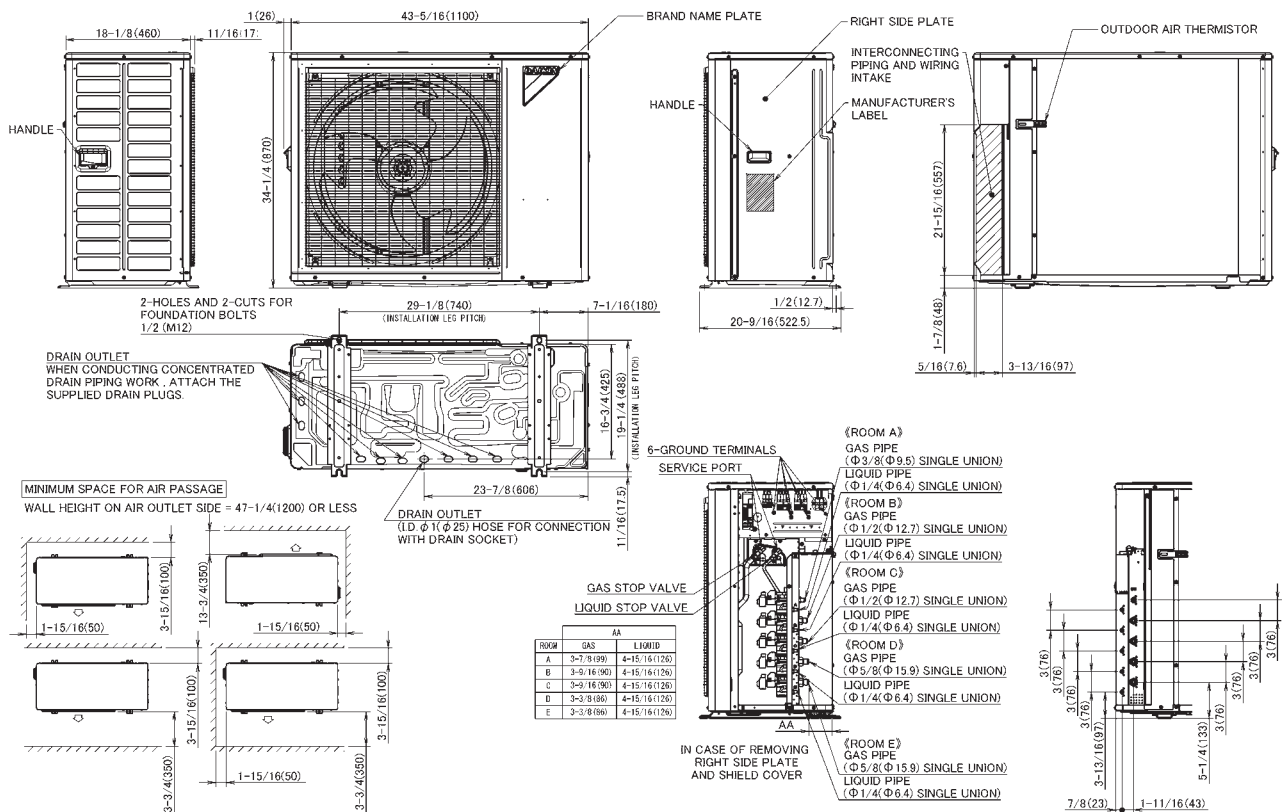

3D118013A

4MXL36WVJU9, 4MXLH36WVJU9

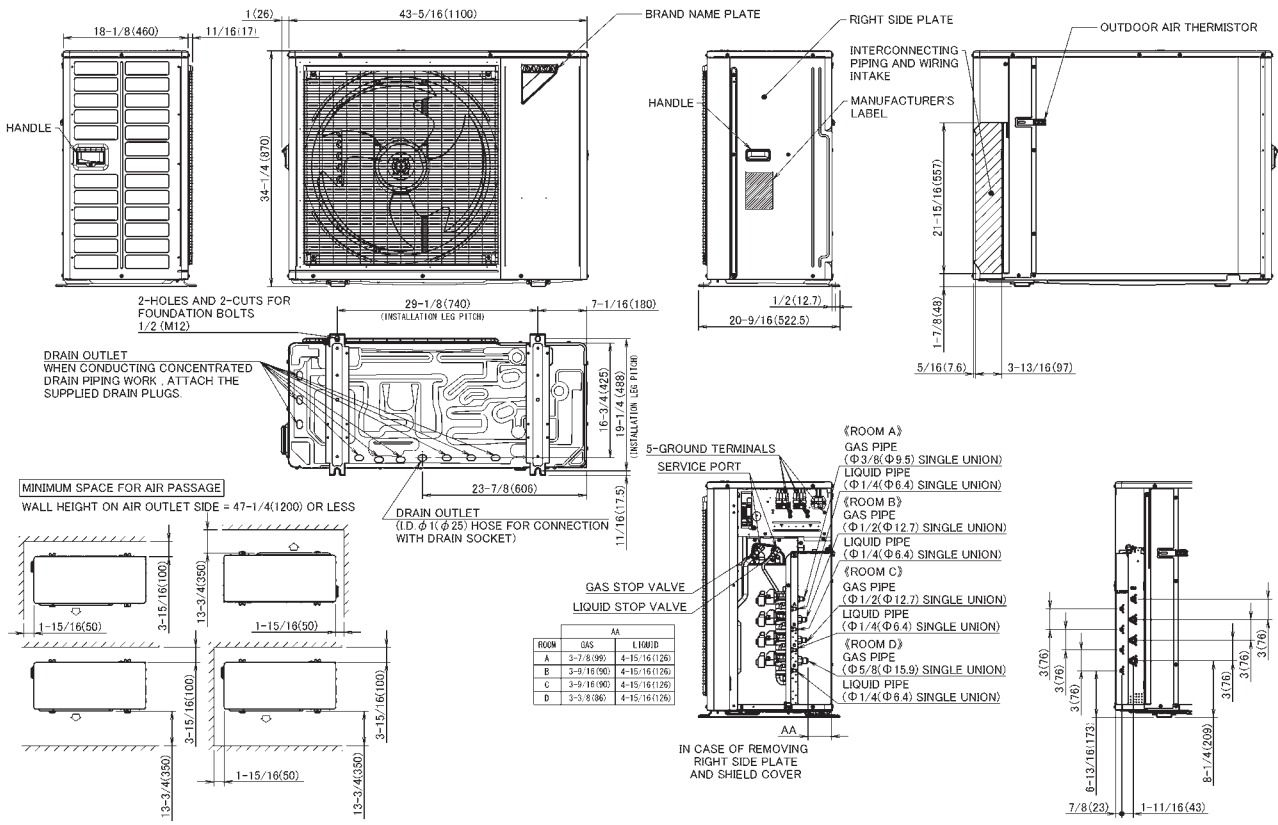

3D118338A

5 Wiring Diagram

5.1 Indoor unit

CTXS07WVJU9, FTXS09/12WVJU9

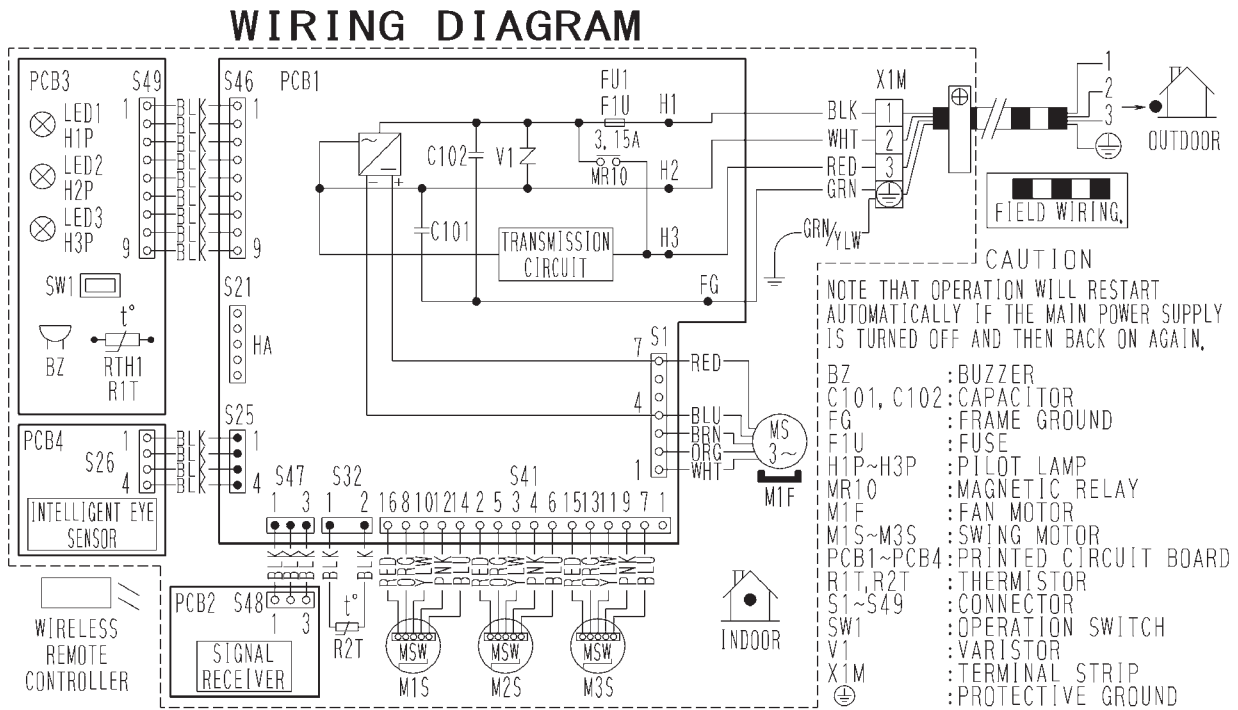

C: 3D058246M

FTXS15/18/24WVJU9

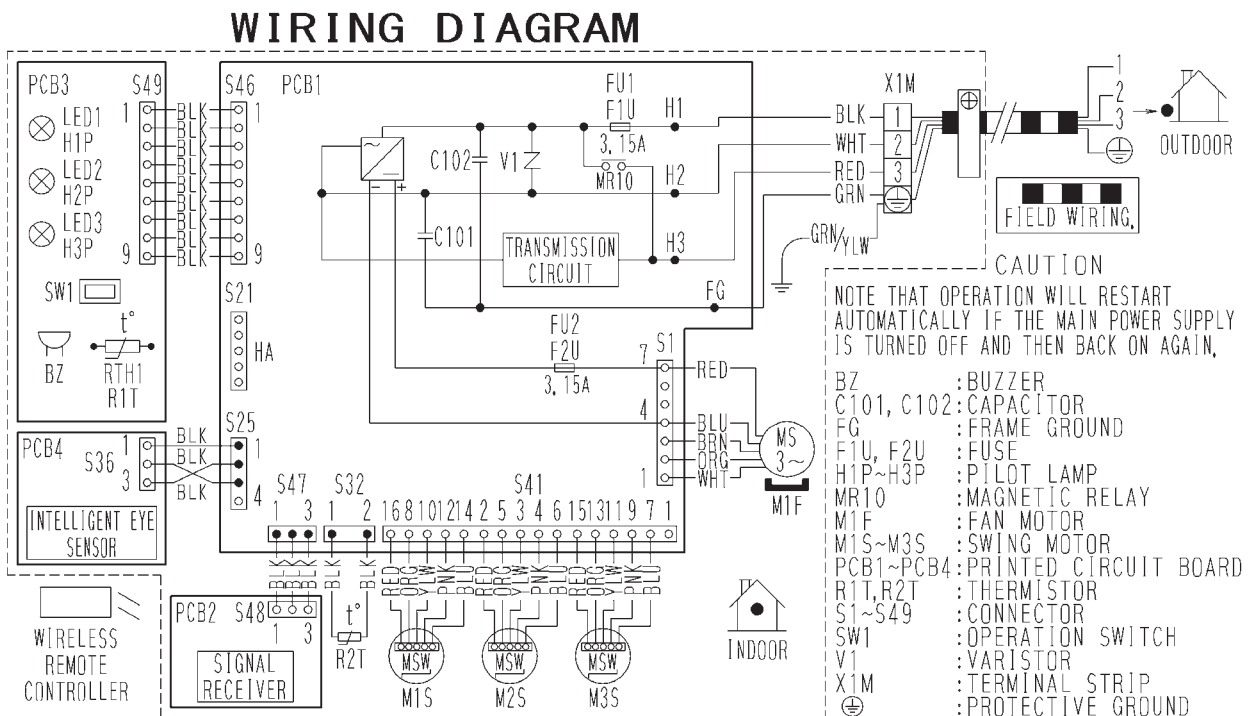

C: 3D060942X

FTXR09/12/18WVJUW(S)9

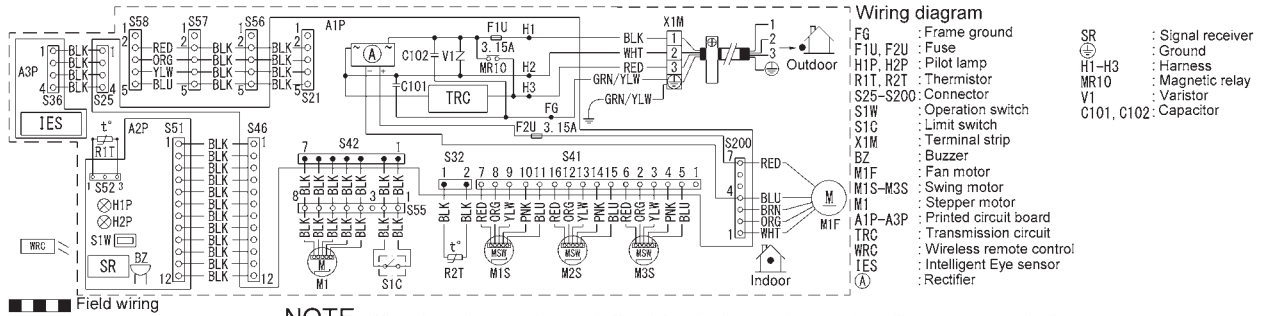

3D103375B

FVXS09/12/15/18WVJU9

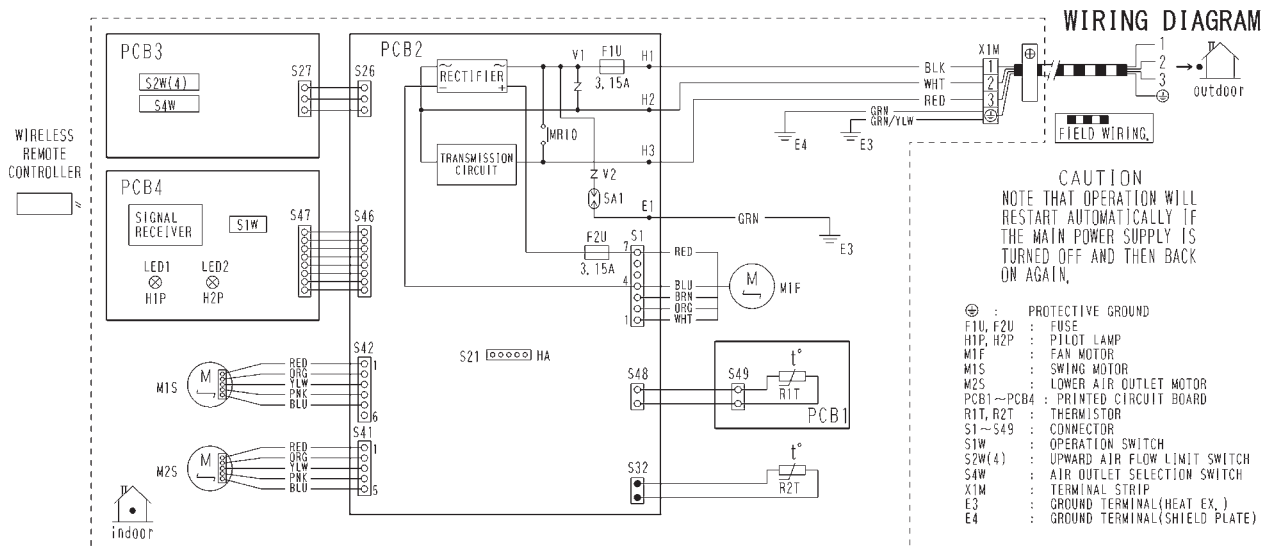

C: 3D090604B

CDMQ07WVJU9, FDMQ09/12/15/18/24WVJU9

WIRING DIAGRAM

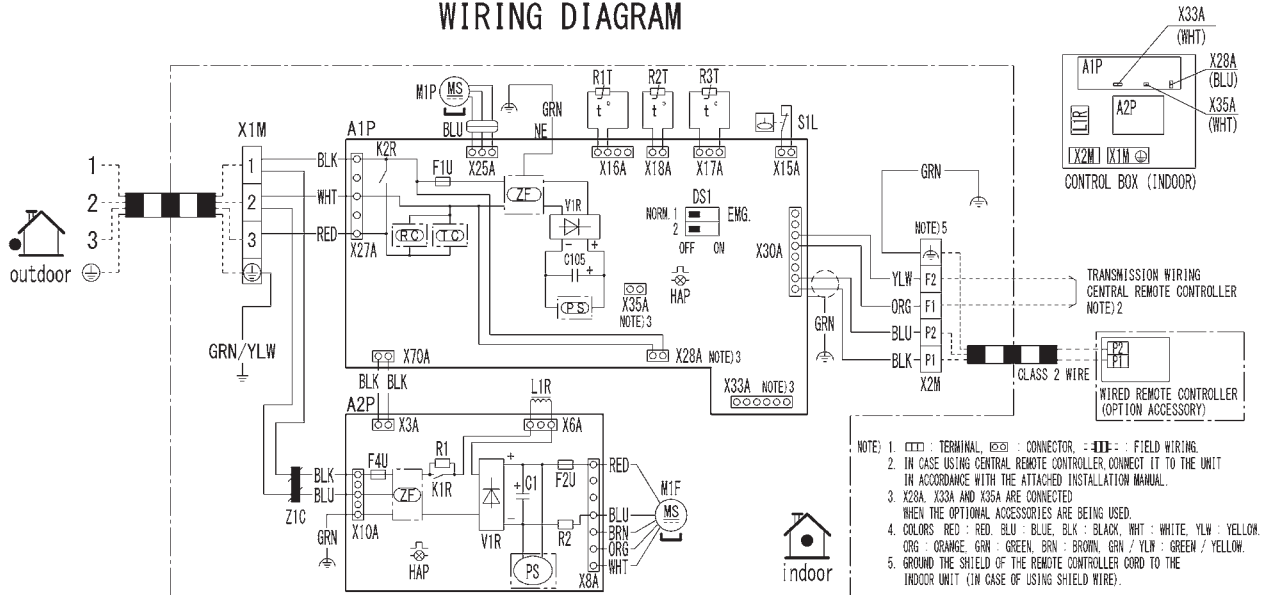

- NOTE: 1. □ : TERMINAL, ⊞ : CONNECTOR, - : FIELD WIRING.
 2. IN CASE USING CENTRAL REMOTE CONTROLLER, CONNECT IT TO THE UNIT IN ACCORDANCE WITH THE ATTACHED INSTALLATION MANUAL.
 3. X28A, X33A AND X35A ARE CONNECTED WHEN THE OPTIONAL ACCESSORIES ARE BEING USED.
 4. COLORS: RED : RED, BLU : BLUE, BLK : BLACK, WHT : WHITE, YLW : YELLOW, ORG : ORANGE, GRN : GREEN, BRN : BROWN, GRN / YLW : GREEN / YELLOW.
 5. GROUND THE SHIELD OF THE REMOTE CONTROLLER CORD TO THE INDOOR UNIT (IN CASE OF USING SHIELD WIRE).

INDOOR UNIT	CONNECTOR	OPTIONAL ACCESSORY
A1P	X28A	CONNECTOR (POWER SUPPLY FOR WIRING)
A2P	X33A	CONNECTOR FOR WIRING
C1	X35A	CONNECTOR (ANTENNA)
C105		CAPACITOR
DS1		DIP SWITCH (EMERGENCY)
F1J		FUSE (T, 3.15A, 250V)
F2J		FUSE (T, 5A, 250V)
F4J		FUSE
HAP		P100 LAMP (SERVICE WINDOW-GRASS)
K1R		MAGNETIC RELAY
K2R		MAGNETIC RELAY
L1R		REACTOR
M1P		MOTOR (FAN (INDOOR))
M1P		MOTOR (DRAIN PUMP)
R1		RESISTOR (CURRENT LIMITING)
R2		CURRENT SENSING DEVICE
R1T		THERMISTOR (SUCTION AIR)
R2T		THERMISTOR (HEAT EXCHANGER)
S1L		FLOAT SWITCH
Y1R		DIODE BRIDGE
X1M		TERMINAL BLOCK (POWER SUPPLY)
X2M		TERMINAL BLOCK (CONTROL)
ZF		NOISE FILTER
Z1C		FERRITE CORE
PS		SWITCHING POWER SUPPLY
RC		RECEIVER
TC		TRANSMITTER

FFQ09/12/15/18W2VJU9

WIRING DIAGRAM

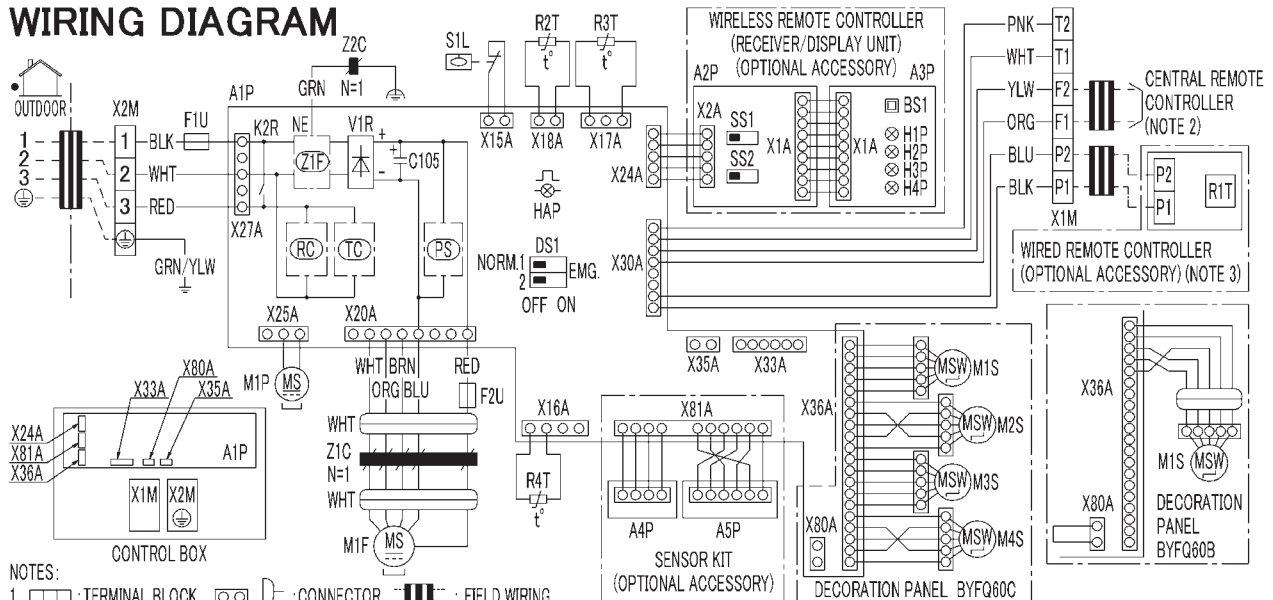

NOTES:

1. [Terminal Block Symbol] : TERMINAL BLOCK, [Connector Symbol] : CONNECTOR, [Field Wiring Symbol] : FIELD WIRING
2. IN CASE USING CENTRAL REMOTE CONTROLLER, CONNECT IT TO THE UNIT IN ACCORDANCE WITH THE ATTACHED INSTALLATION MANUAL.
3. IN CASE OF MAIN/SUB CHANGEOVER, SEE THE INSTALLATION MANUAL ATTACHED TO WIRELESS REMOTE CONTROLLER.
4. SYMBOLS SHOW AS FOLLOWS: BLK:BLACK RED:RED BLU:BLUE WHT:WHITE YLW:YELLOW GRN:GREEN ORG:ORANGE BRN:BROWN PNK:PINK

INDOOR UNIT		WIRELESS REMOTE CONTROLLER (RECEIVER/DISPLAY UNIT)	
A1P	PRINTED CIRCUIT BOARD	A2P·A3P	PRINTED CIRCUIT BOARD
C105	CAPACITOR(M1F)	BS1	PUSH BUTTON SWITCH ON PCB
DS1	DIP SWITCH ON PCB	H1P	PILOT LAMP (ON-RED)
F1U	FUSE(F.5A 250V)	H2P	PILOT LAMP (TIMER-GREEN)
F2U	FUSE(F.3.15A 500V)	H3P	PILOT LAMP (FILTER SIGN-RED)
HAP	FLASHING LAMP (SERVICE MONITOR GREEN)	H4P	PILOT LAMP (DEFROST-ORANGE)
K2R	MAGNETIC RELAY	SS1	SELECTOR SWITCH (MAIN-SUB)
M1F	FAN MOTOR	SS2	SELECTOR SWITCH (WIRELESS ADDRESS SET)
M1P	DRAIN PUMP MOTOR	SENSOR KIT	
M1S·M2S	SWING MOTOR	A4P	PRINTED CIRCUIT BOARD
M3S·M4S	SWING MOTOR	A5P	PRINTED CIRCUIT BOARD
R2T·R3T	THERMISTOR(COIL)	CONNECTOR FOR OPTIONAL PARTS	
R4T	THERMISTOR(AIR)	X24A	CONNECTOR (WIRING REMOTE CONTROLLER)
S1L	FLOAT SWITCH	X33A	CONNECTOR (ADAPTOR FOR WIRING)
V1R	DIODE BRIDGE	X35A	CONNECTOR (POWER SUPPLY FOR ADAPTOR)
X1M	TERMINAL BLOCK	X81A	CONNECTOR (SENSOR KIT)
X2M	TERMINAL BLOCK		
Z1F	NOISE FILTER		
Z1C	FERRITE CORE		
Z2C	FERRITE CORE		
PS	SWITCHING POWER SUPPLY		
RC	RECEIVER		
TC	TRANSMITTER		
WIRED REMOTE CONTROLLER			
R1T	THERMISTOR(AIR)		

5.2 Outdoor unit 2MXS18WMVJU9, 2MXL18WMVJU9

WIRING DIAGRAM

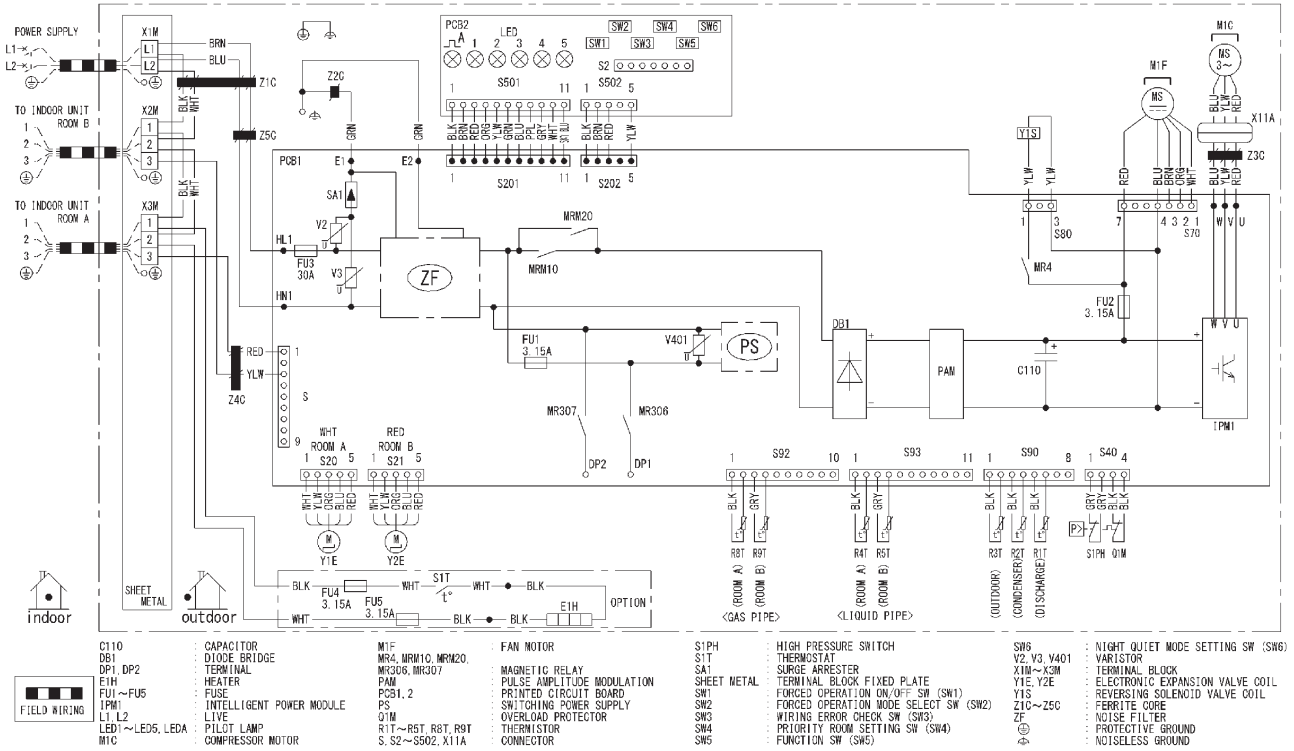

C: 3D13951

3MXS24WMVJU9, 3MXL24WMVJU9

WIRING DIAGRAM

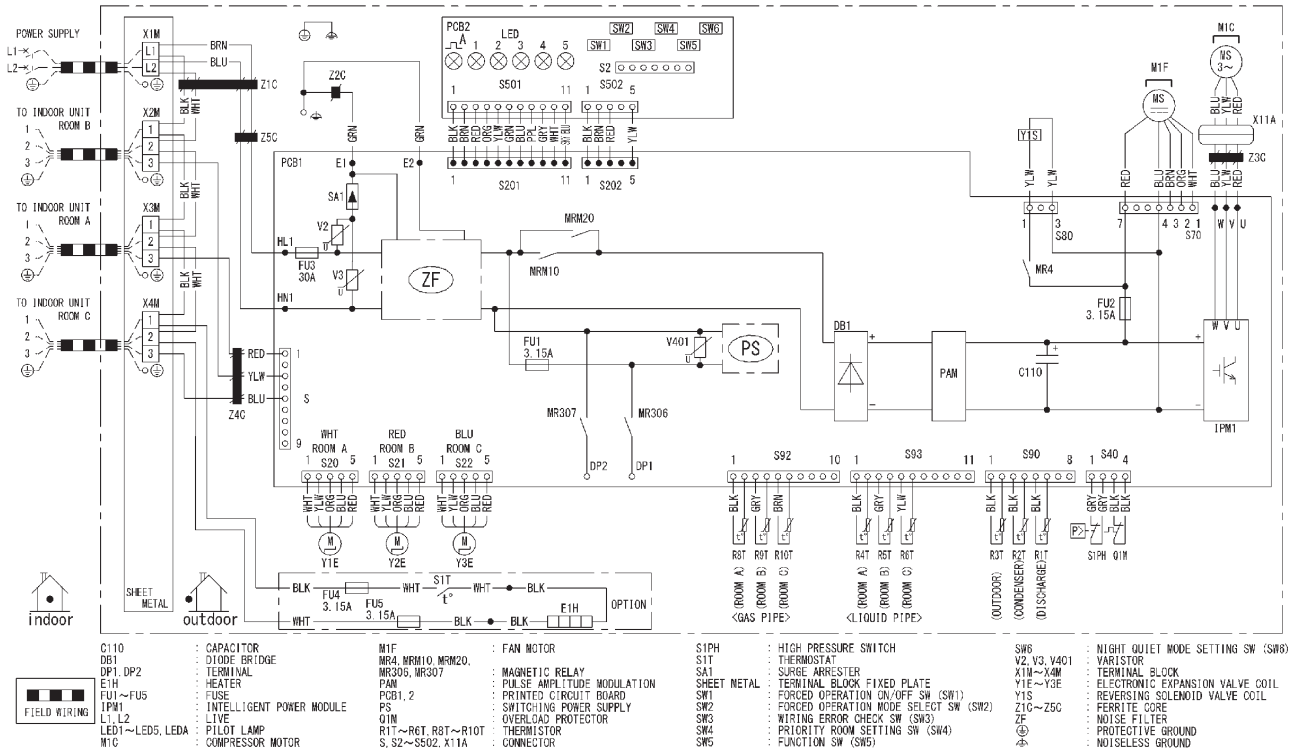

C: 3D13959

4MXS36WMVJU9

WIRING DIAGRAM

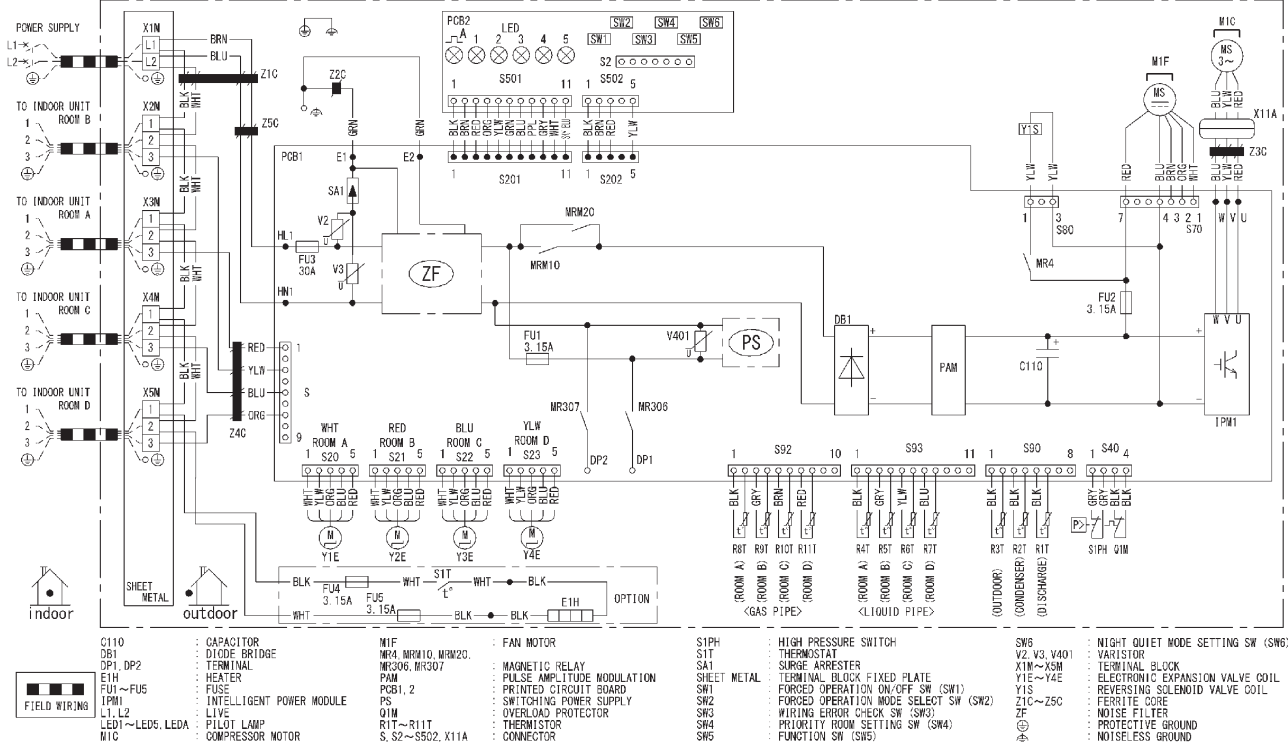

C: 3D139601

5MXS48WVJU9

WIRING DIAGRAM

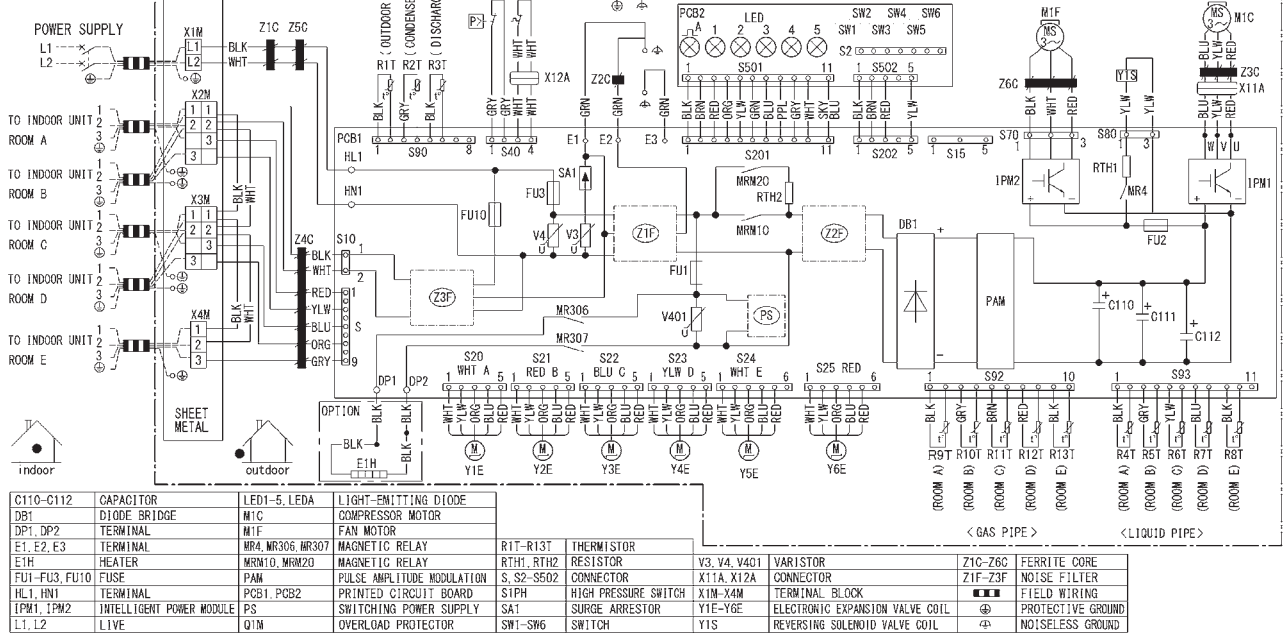

C: 3D139636

4MXL36WVJU9

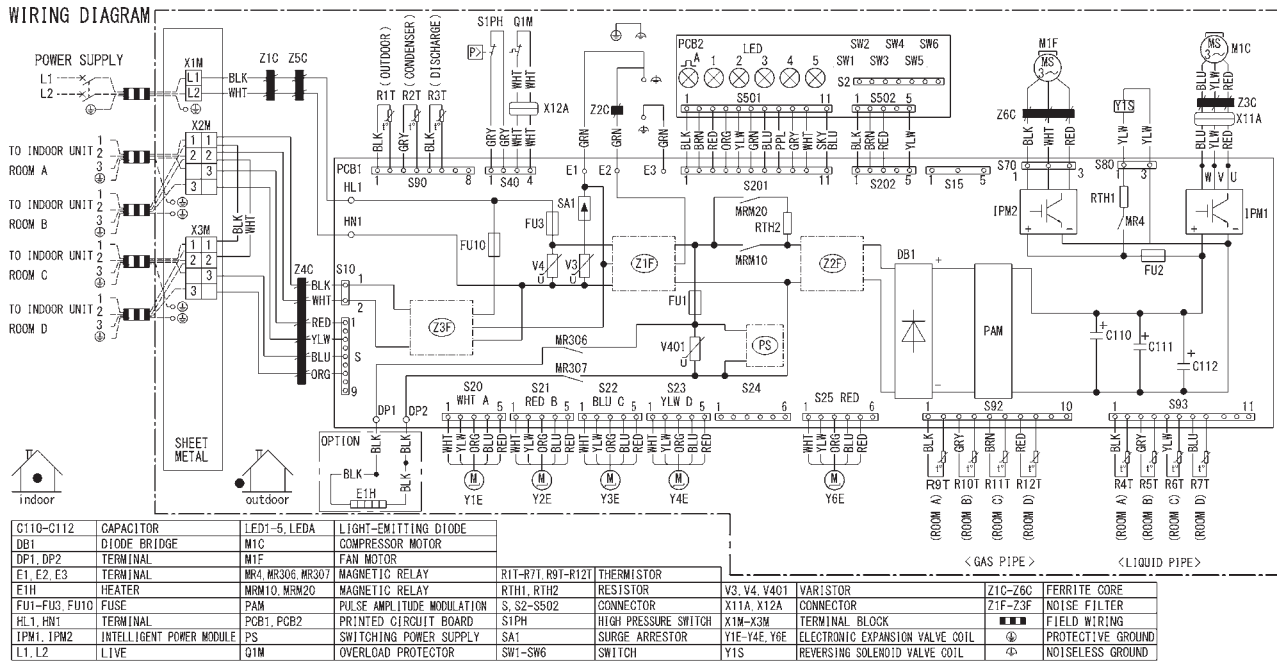

C: 3D139623

2MXLH18WVJU9

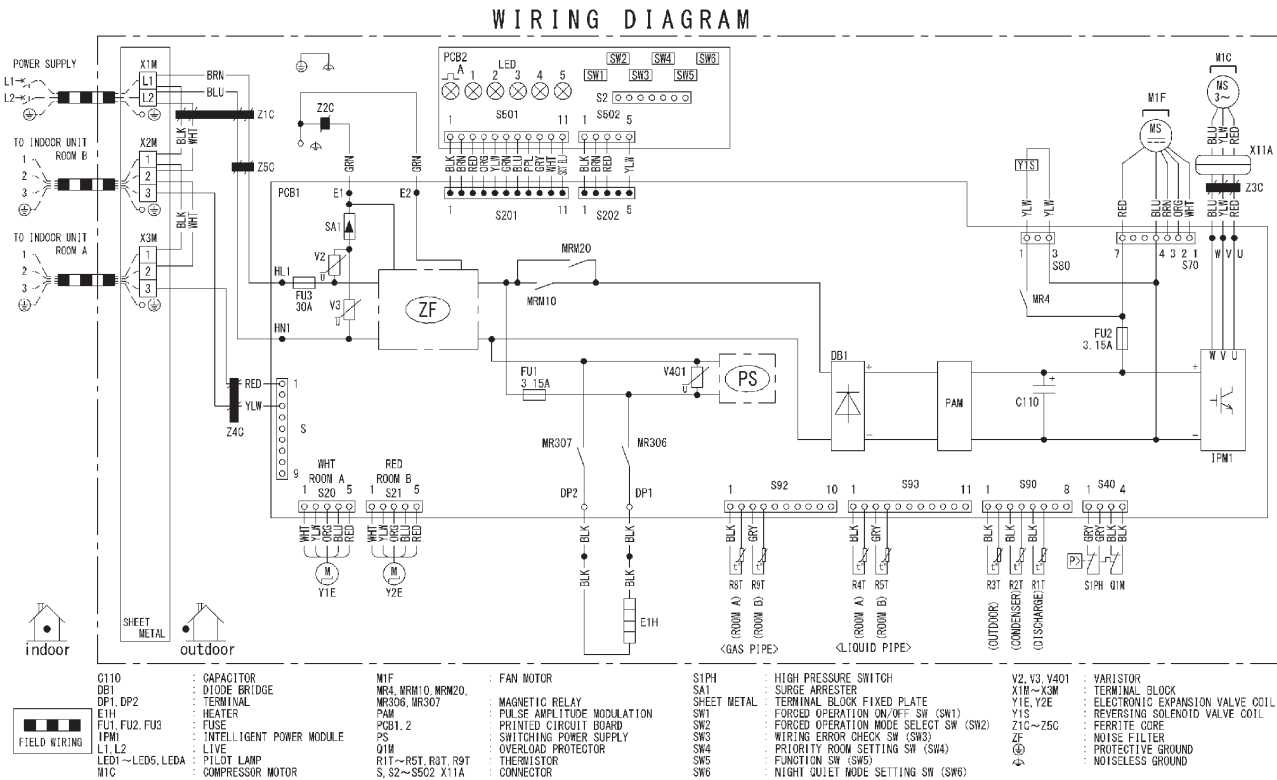

C: 3D139560

3MXLH24VWJU9

WIRING DIAGRAM

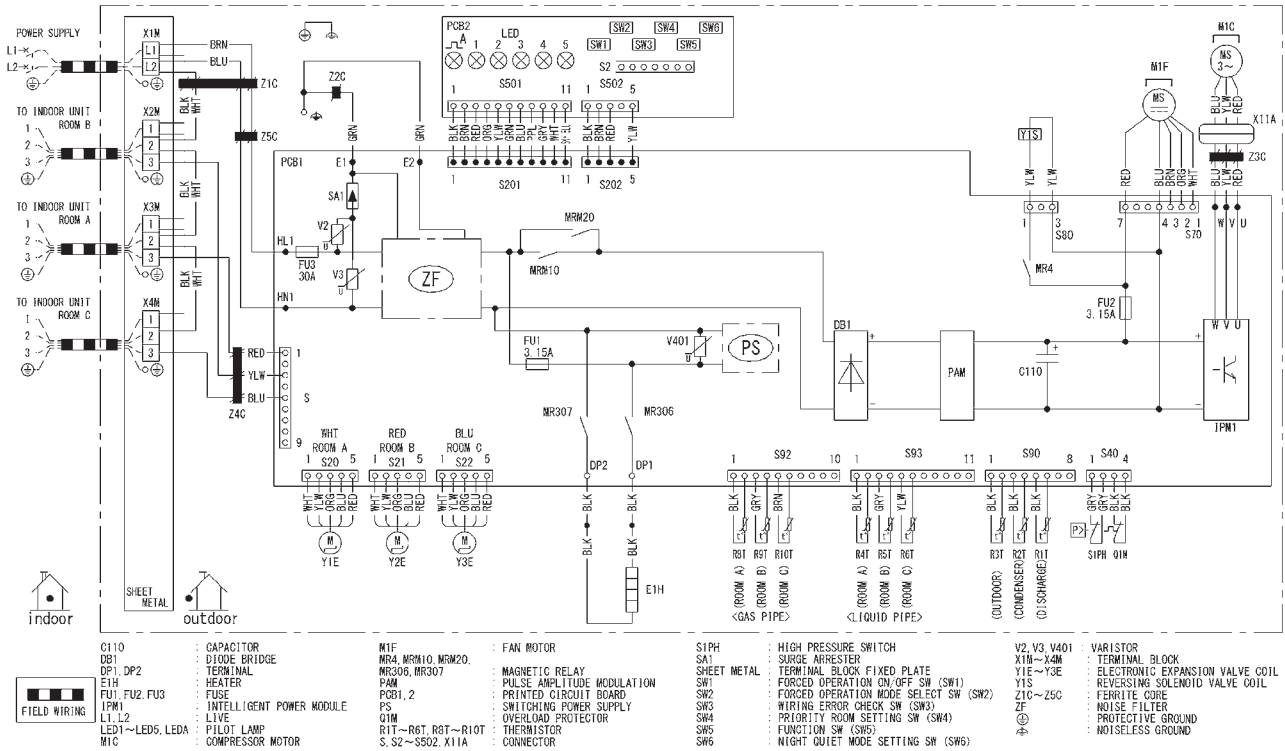

C: 3D139564

4MXLH36VWJU9

WIRING DIAGRAM

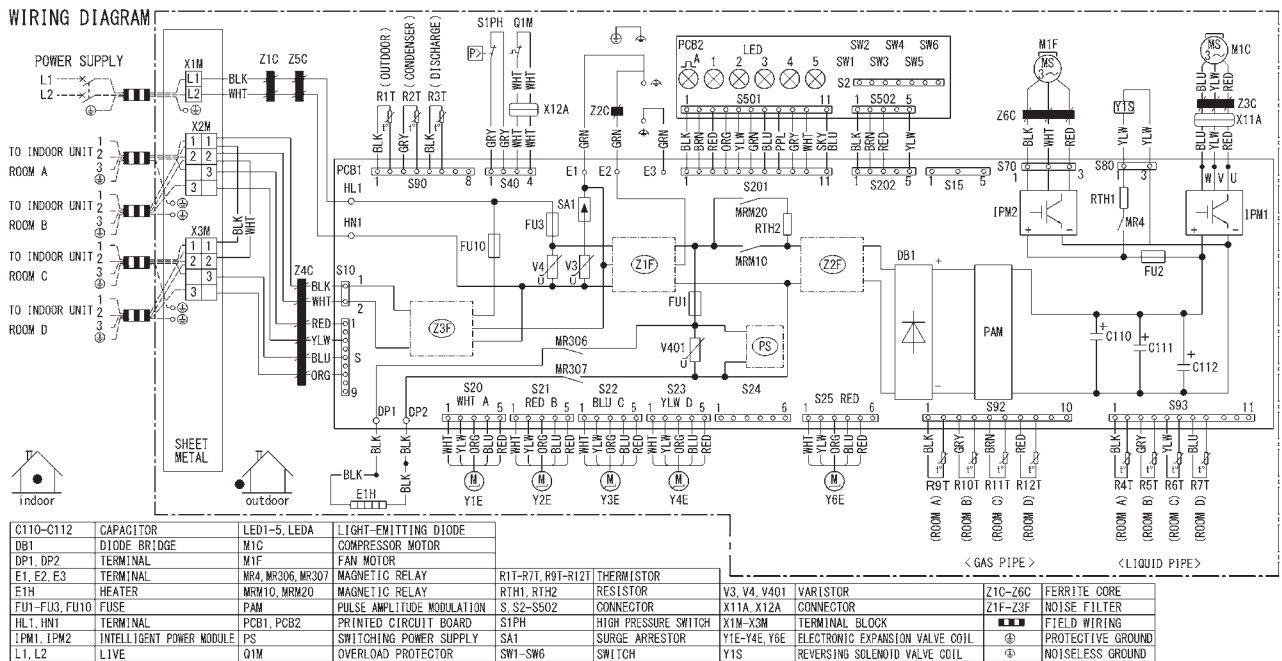

C: 3D139621

6 Piping Diagram

6.1 Indoor unit

CTXS07WVJU9, FTXS09/12WVJU9

FTXS15/18WVJU9

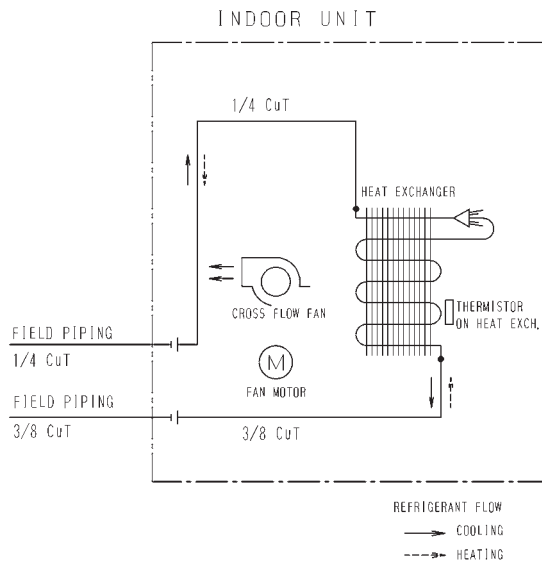

4D074606A

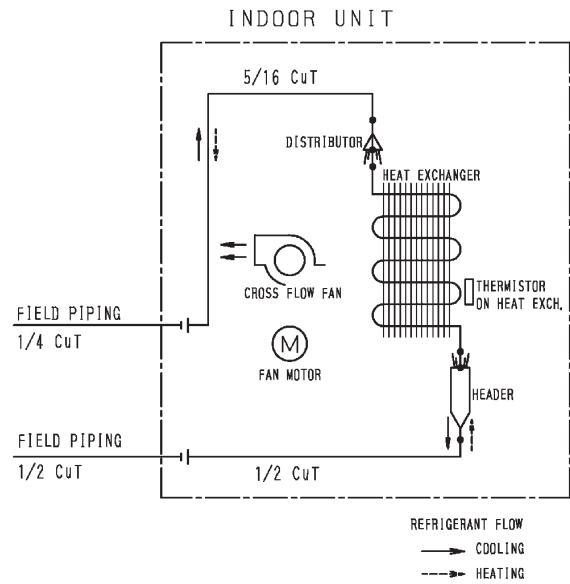

4D074609A

FTXS24WVJU9

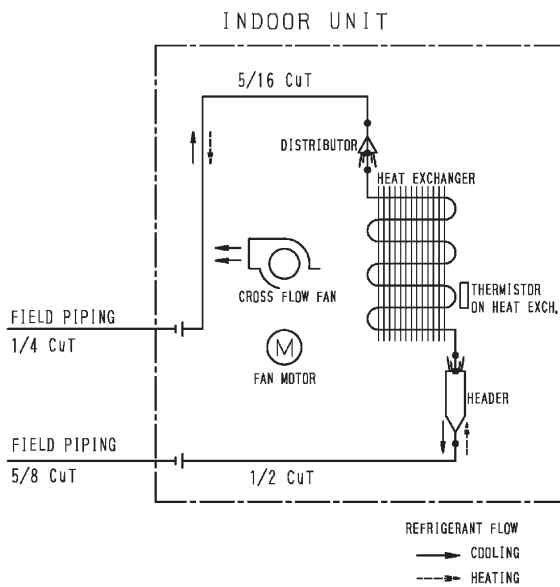

4D074608A

FTXR09/12WVJUW(S)9

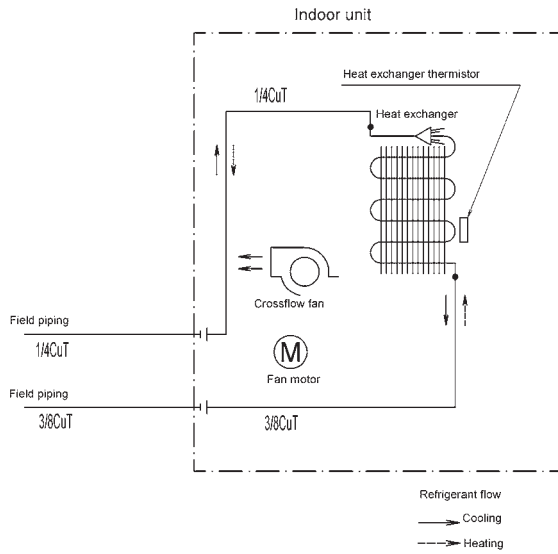

4D101008B

FTXR18WVJUW(S)9

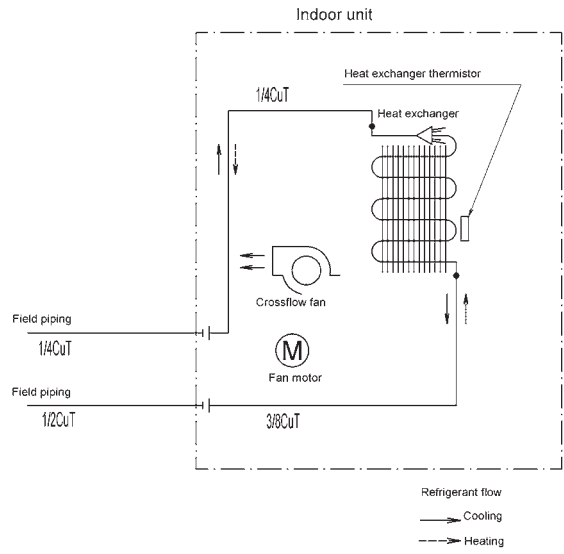

4D101010B

FVXS09/12WVJU9

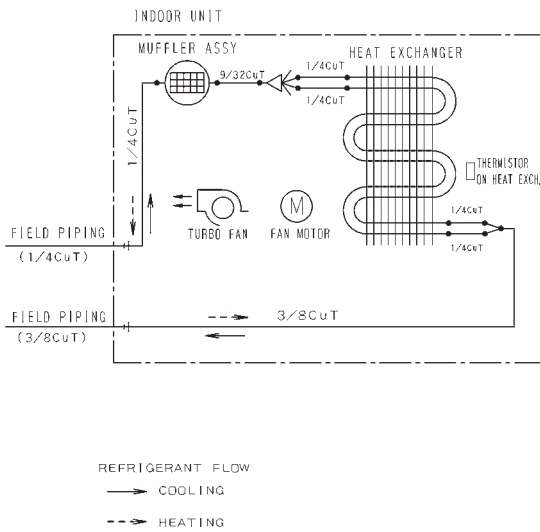

4D091794A

FVXS15/18WVJU9

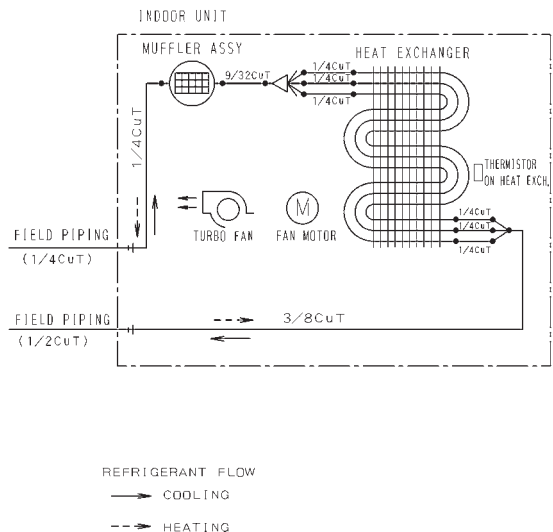

4D091795B

CDMQ07WVJU9, FDMQ09/12/15/18/24WVJU9

FFQ09/12/15/18W2VJU9

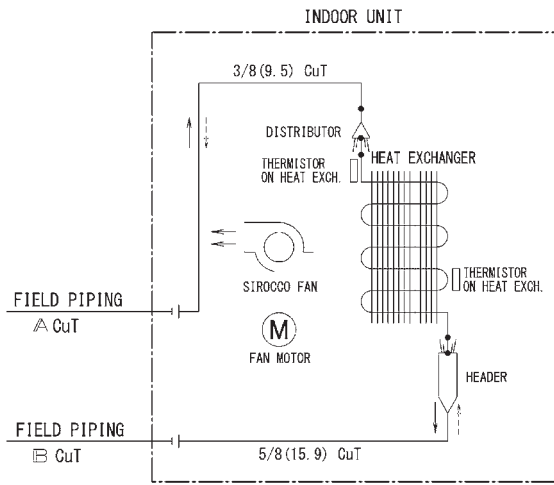

MODEL	A	B
FDMQ09 - 12 CDMQ07	1/4 (6.4)	3/8 (9.5)
FDMQ15 - 18	1/4 (6.4)	1/2 (12.7)
FDMQ24	1/4 (6.4)	5/8 (15.9)

REFRIGERANT FLOW
 ———> COOLING
 - - -> HEATING

C: 4D112974B

REFRIGERANT FLOW

COOLING ———>
 HEATING - - ->

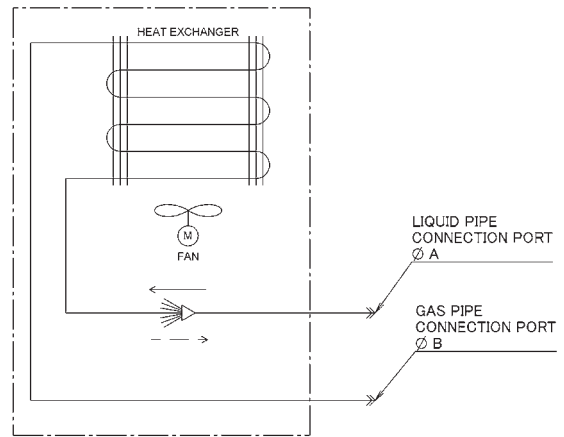

MODEL	A	B
FFQ09W2VJU9	1/4 (6.4)	3/8 (9.5)
FFQ12W2VJU9		1/2 (12.7)
FFQ15W2VJU9		
FFQ18W2VJU9		

C: 4D106033A

6.2 Outdoor unit 2MXS18WMVJU9

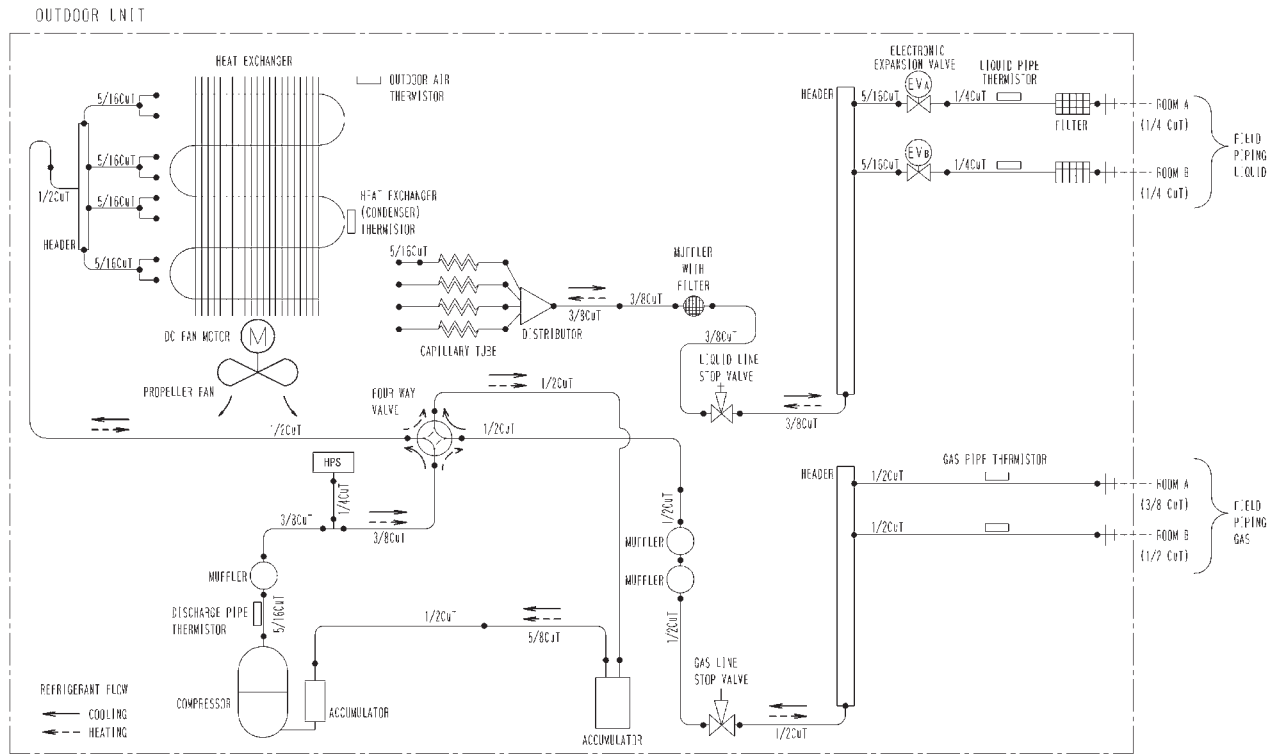

3D140919

3MXS24WMVJU9, 3MXL24WMVJU9, 3MXLH24WVJU9

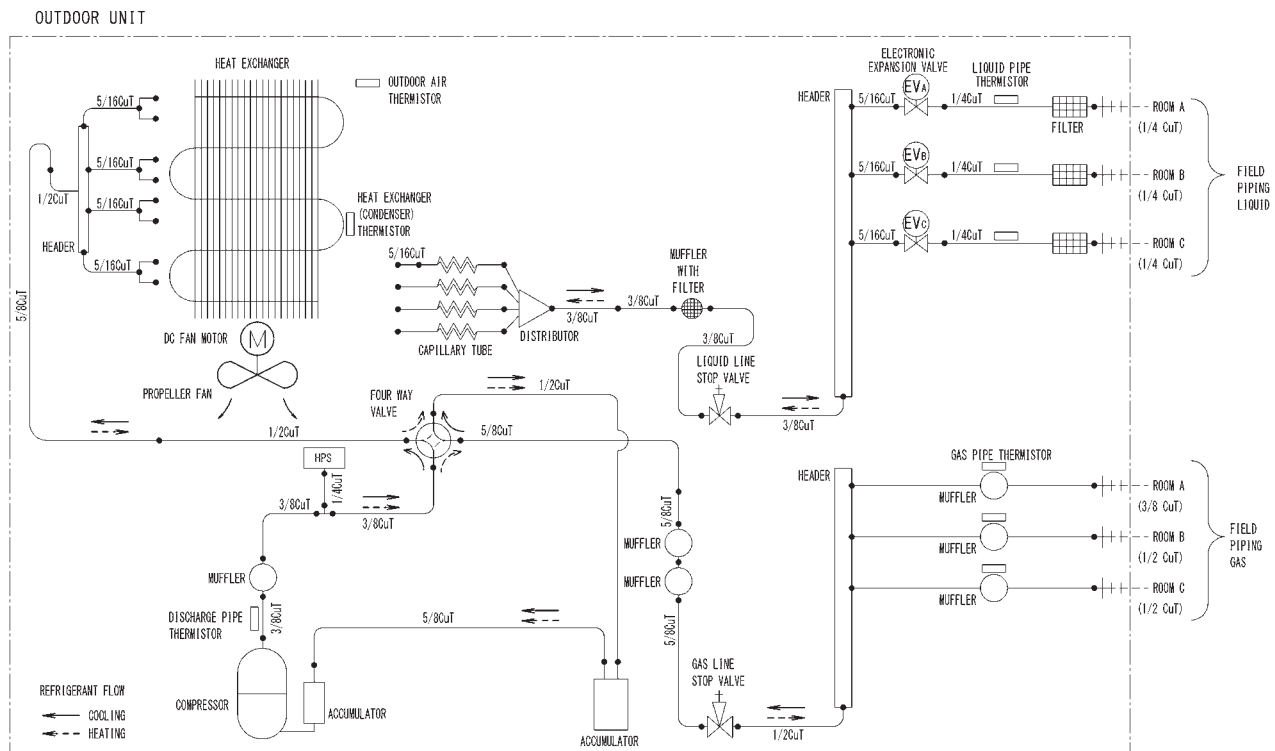

3D140915

4MXS36WMVJU9

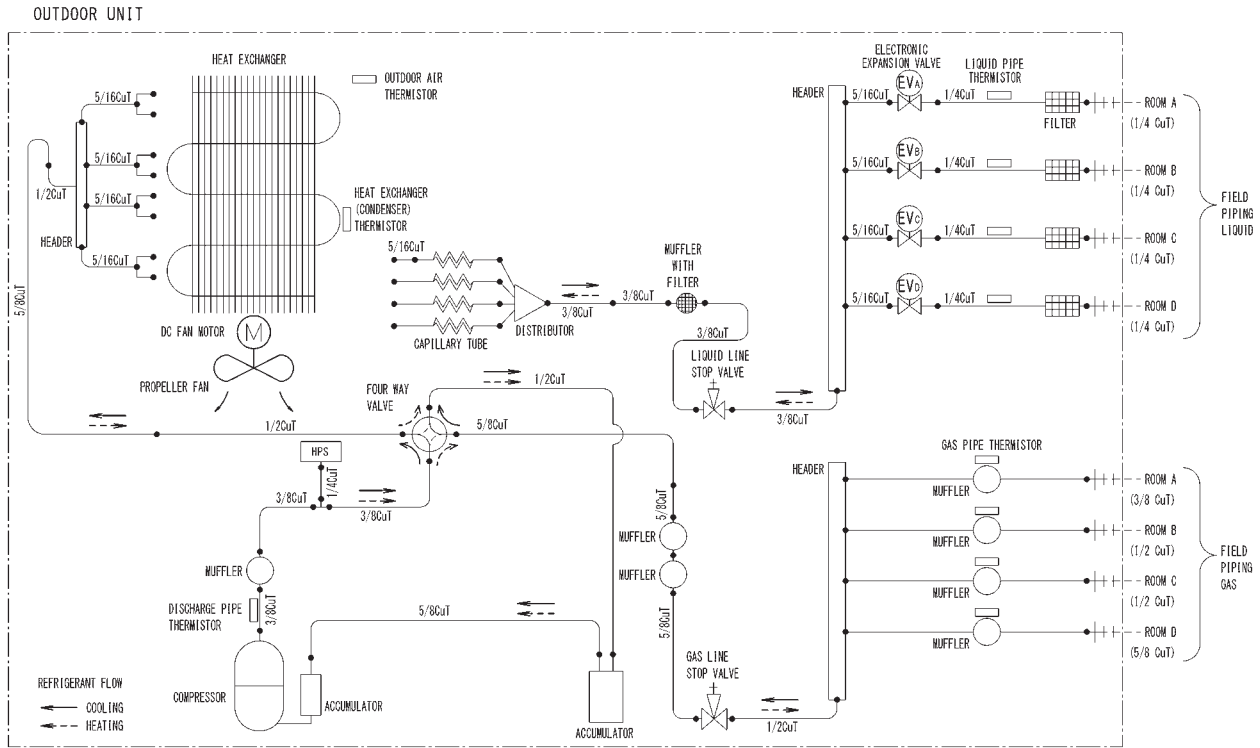

3D140918

5MXS48WVJU9

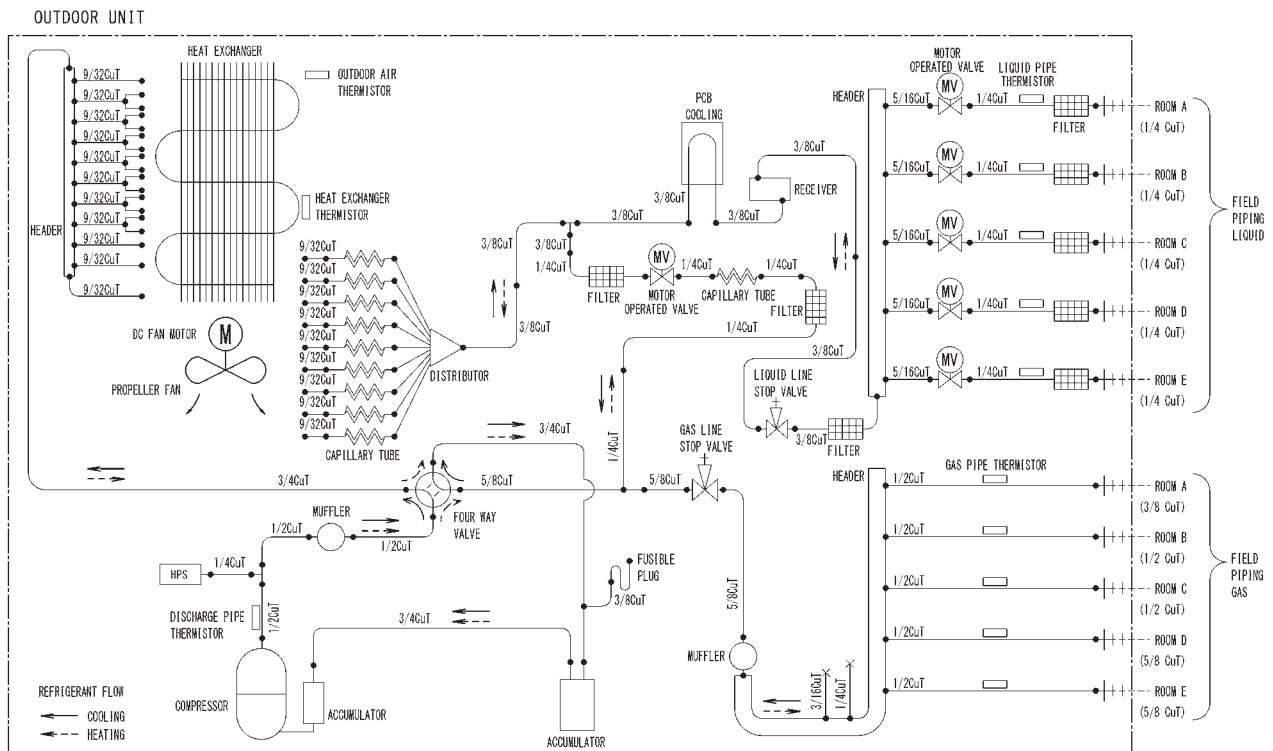

3D140985

2MXL18WMVJU9, 2MXLH18WVJU9

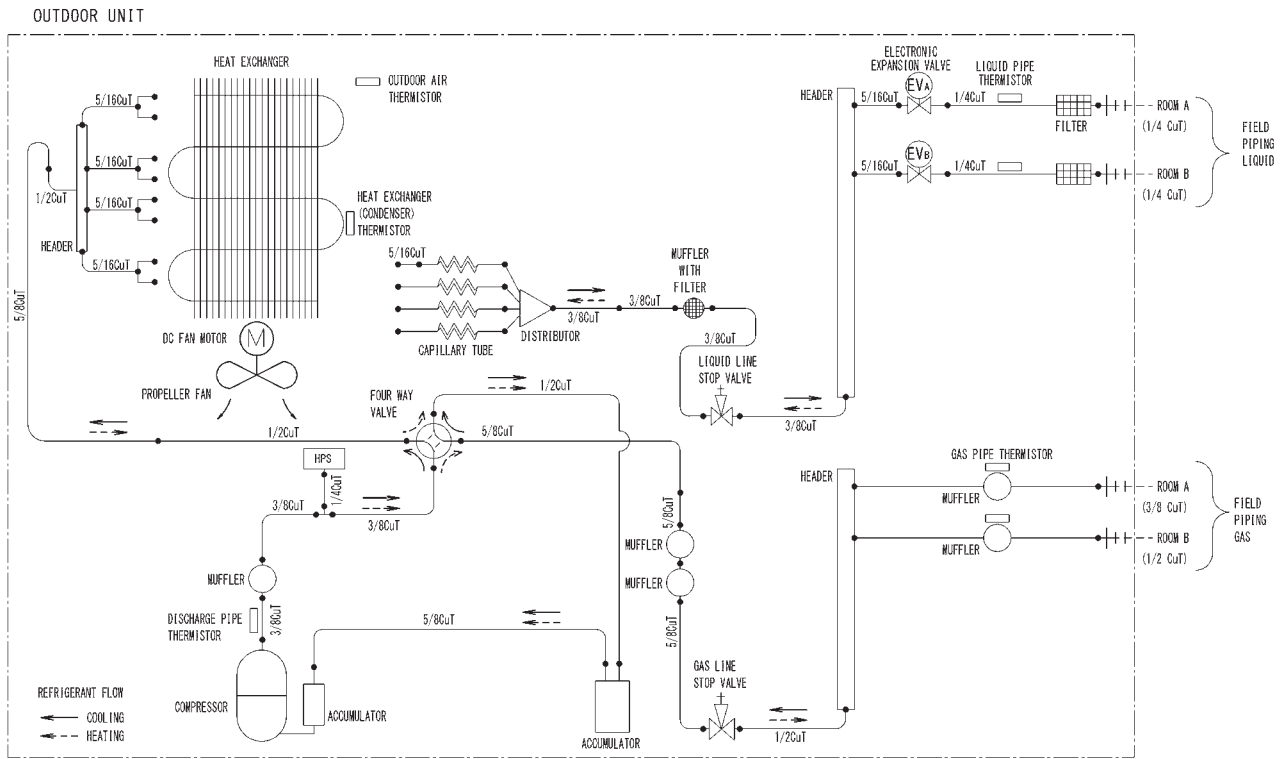

3D140914

4MXL36WVJU9, 4MXLH36WVJU9

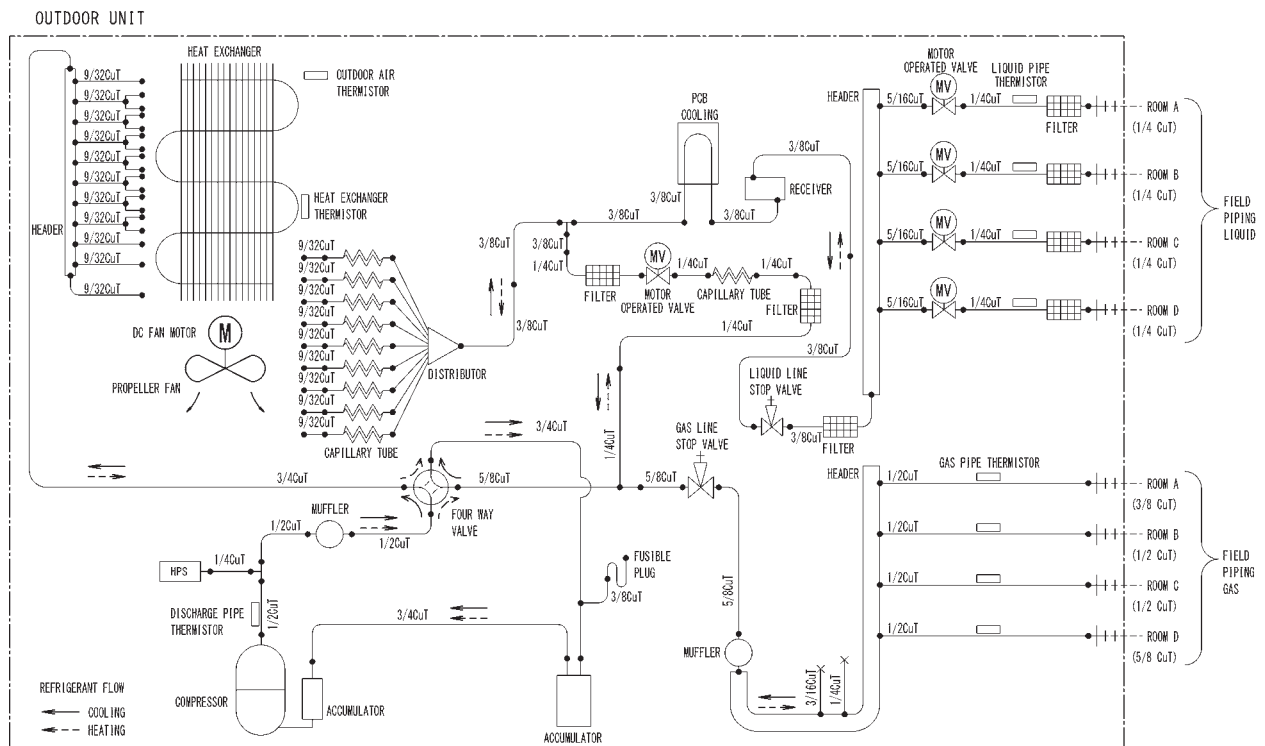

3D140984

7 Capacity Table

Refer to Engineering Data books below for the Combination Capacity.

Type	Model Name	Reference
Standard type	2MXS18WMVJU9 3MXS24WMVJU9 4MXS36WMVJU9 5MXS48WVJU9	EDUS122206
Cold climate type	2MXL18WMVJU9 3MXL24WMVJU9 4MXL36WVJU9 2MXLH18WVJU9 3MXLH24WVJU9 4MXLH36WVJU9	EDUS122207

8 Operation Limit

2MXS18WMVJU9, 3MXS24WMVJU9, 4MXS36WMVJU9, 5MXS48WVJU9

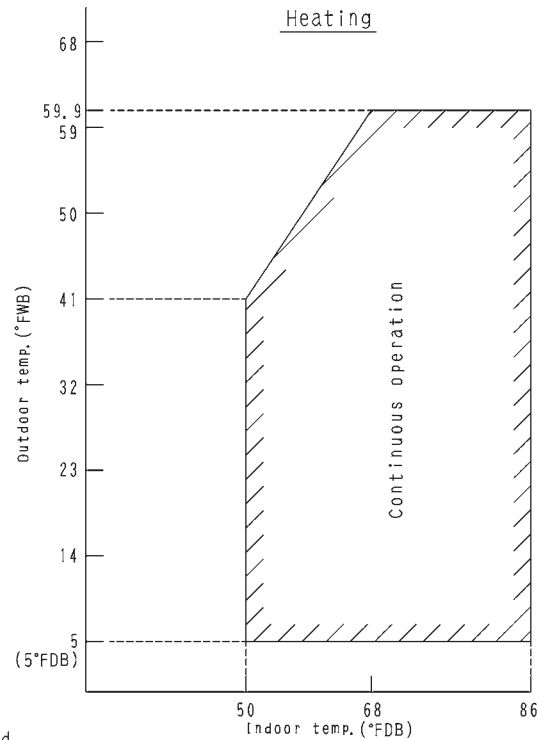
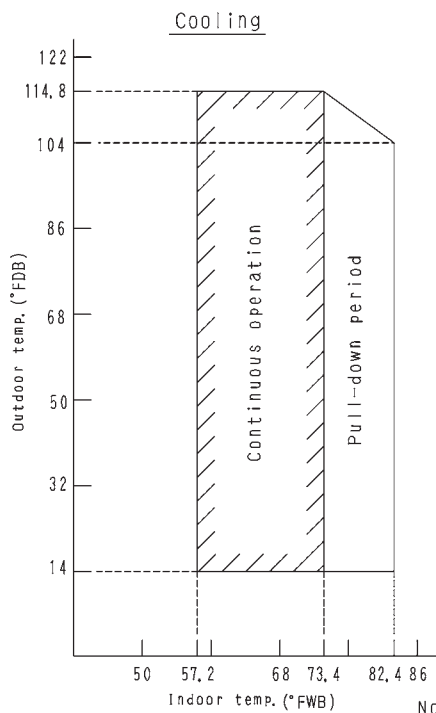

Notes:
 The graphs are based on the following conditions.
 • Equivalent piping length 25ft
 • Level difference 0ft
 • Air flow rate High

3D048149D

2MXL(H)18W(M)VJU9, 3MXL(H)24W(M)VJU9, 4MXL(H)36WVJU9

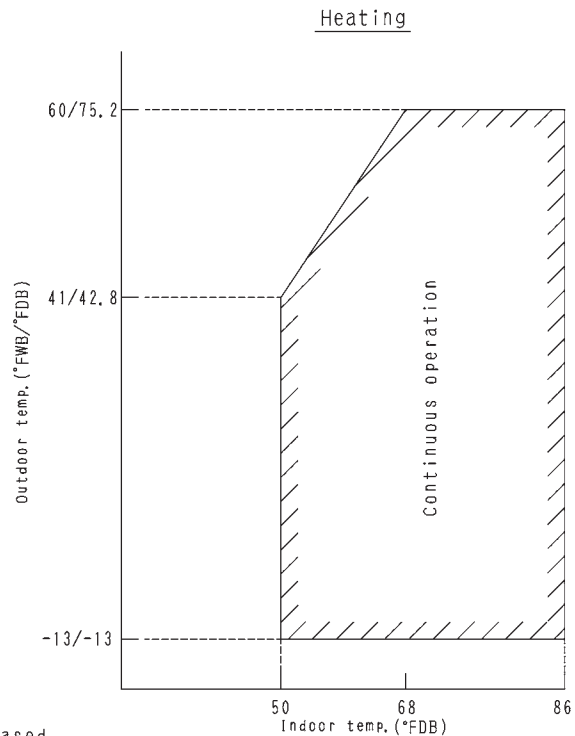
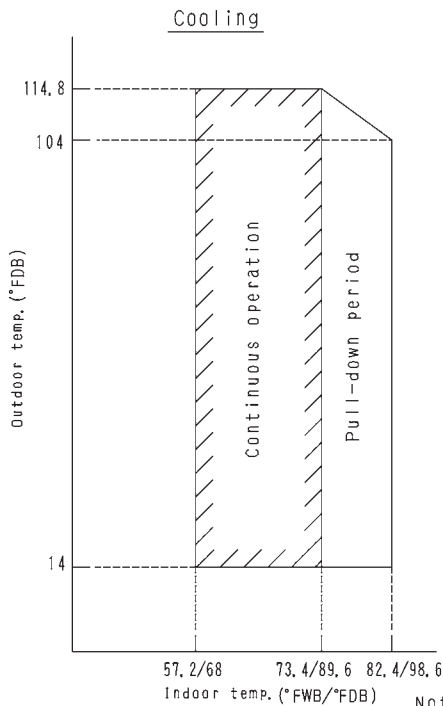

Notes:
 The graphs are based on the following conditions.
 • Equivalent piping length 25ft
 • Level difference 0ft
 • Air flow rate High

3D101428B

9 Fan Characteristics

9.1 External Static Pressure

CDMQ07WVJU9

Fan characteristics ①

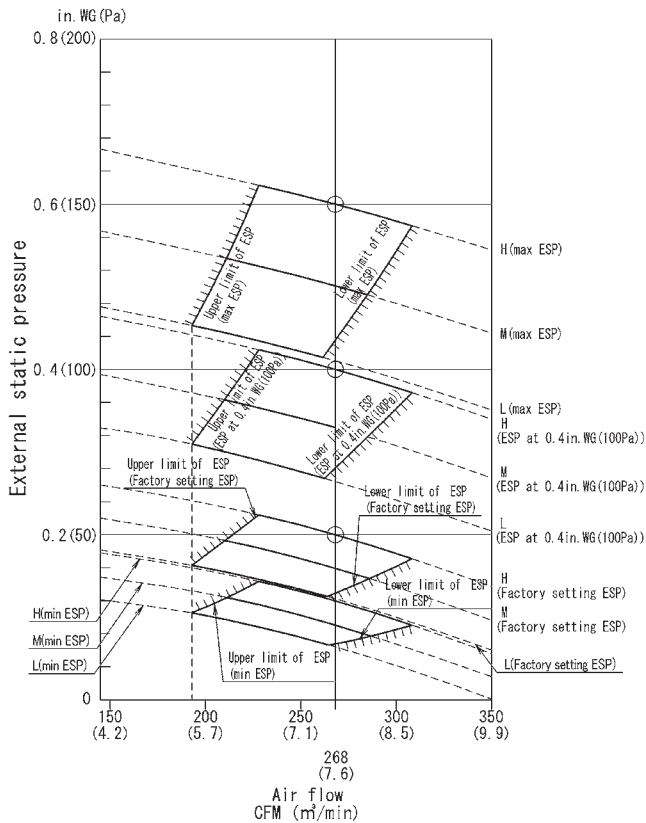

Fan characteristics ②
(For field setting of remote controller)

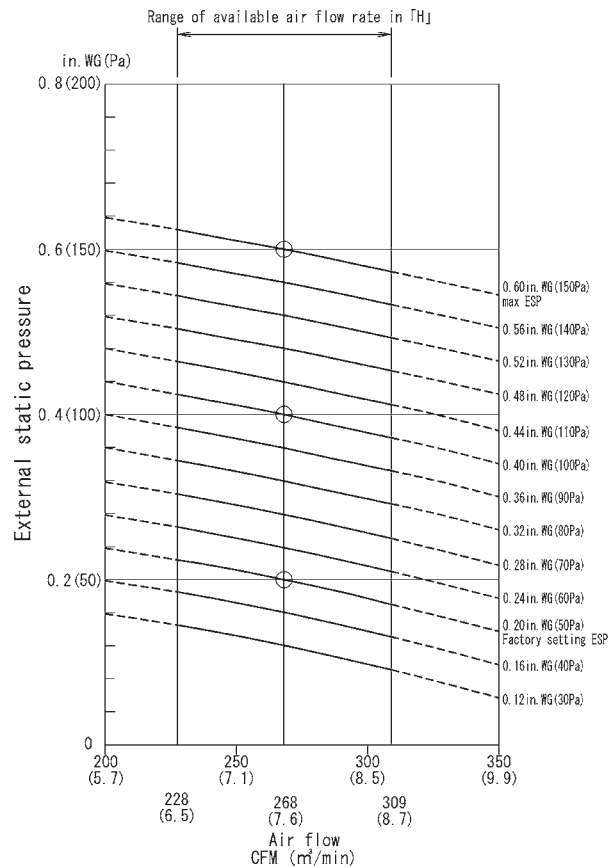

- Notes:
1. Fan characteristics at the time of rear suction and bottom suction are similar to each other.
 2. Fan characteristics ① shows a representative of fan characteristics at the time of "Maximum ESP", "ESP at 0.4in.WG(100Pa)", "Factory setting ESP" and "Minimum ESP".
 3. A remote controller can be used to change airflow rate of "H", "M" and "L".
 4. Set the ESP on suction side to 0.4in.WG(100Pa) or less.
 5. Fan characteristics ② (for field setting of remote controller) shows fan characteristics of airflow "H" which can be changed in the field setting by a remote controller.
 6. Select ESP setting in accordance with resistance of the connected duct by using Fan characteristics ① and ② (Factory setting ESP is 0.2in.WG(50Pa). See installation manual for ESP setting procedure.)
 7. The ESP setting of this unit can be changed into 13 levels.
 8. The value of Fan characteristics ② mentioned in this drawing shows the ESP of rated airflow.

ESP : external static pressure

FDMQ09WVJU9

Fan characteristics ①

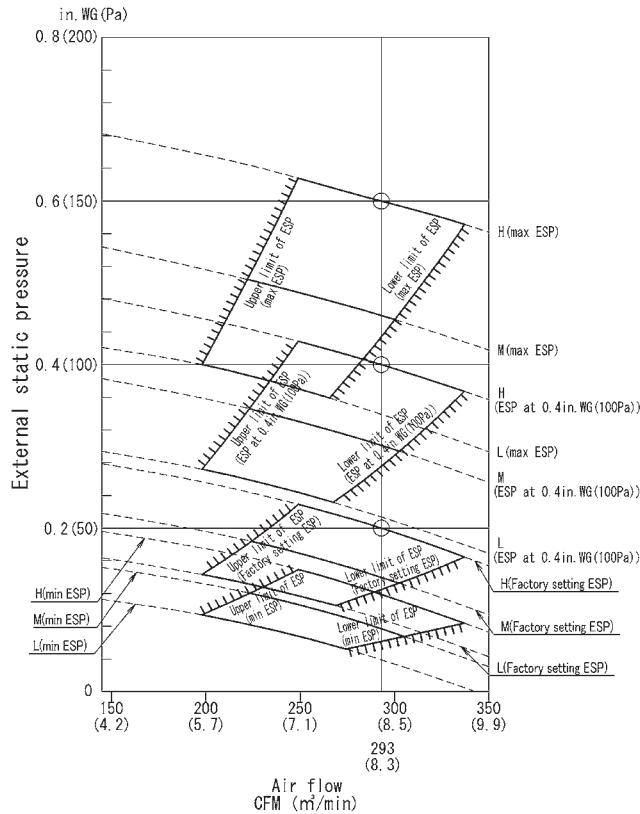

Fan characteristics ②
(For field setting of remote controller)

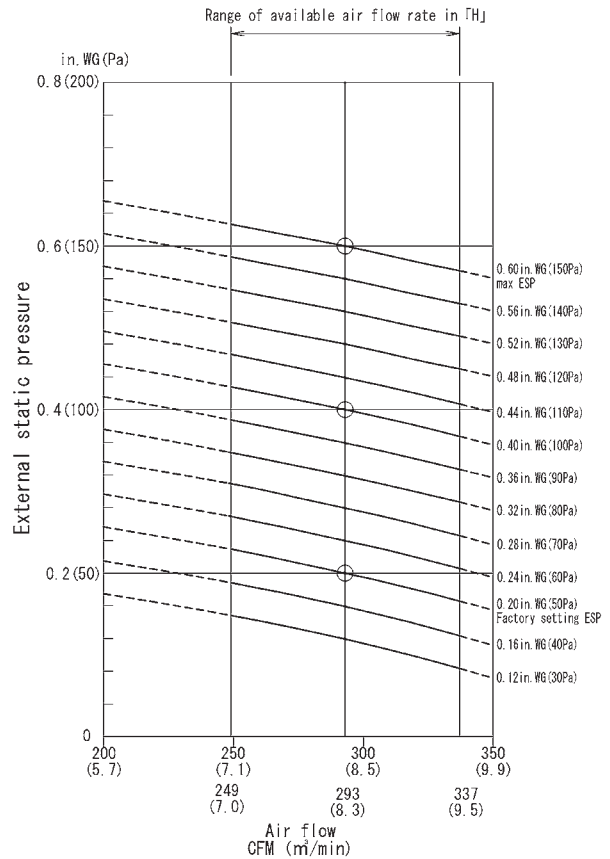

Notes:

1. Fan characteristics at the time of rear suction and bottom suction are similar to each other.
2. Fan characteristics ① shows a representative of fan characteristics at the time of "Maximum ESP", "ESP at 0.4 in. WG (100Pa)", "Factory setting ESP" and "Minimum ESP".
3. A remote controller can be used to change airflow rate of "H", "M" and "L".
4. Set the ESP on suction side to 0.4 in. WG (100Pa) or less.
5. Fan characteristics ② (for field setting of remote controller) shows fan characteristics of airflow "H" which can be changed in the field setting by a remote controller.
6. Select ESP setting in accordance with resistance of the connected duct by using Fan characteristics ① and ② (Factory setting ESP is 0.2 in. WG (50Pa). See installation manual for ESP setting procedure.)
7. The ESP setting of this unit can be changed into 13 levels.
8. The value of Fan characteristics ② mentioned in this drawing shows the ESP of rated airflow.

ESP : external static pressure

FDMQ12WVJU9

Fan characteristics ①

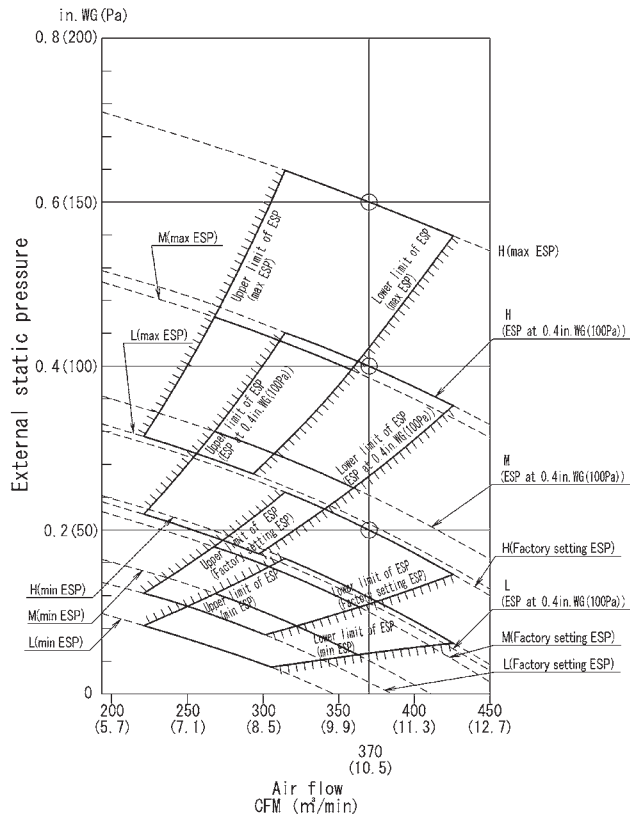

Fan characteristics ②
(For field setting of remote controller)

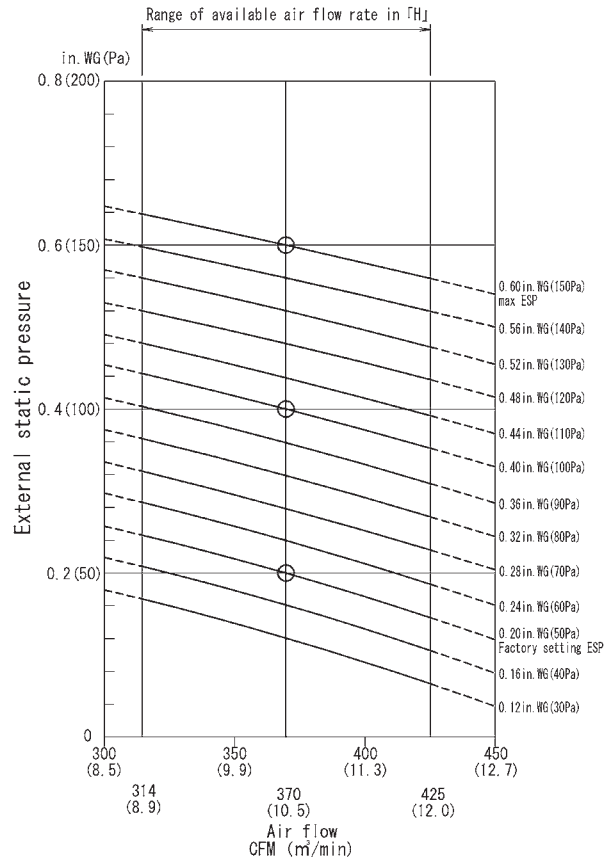

Notes:

1. Fan characteristics at the time of rear suction and bottom suction are similar to each other.
2. Fan characteristics① shows a representative of fan characteristics at the time of "Maximum ESP", "ESP at 0.4in.WG(100Pa)", "Factory setting ESP" and "Minimum ESP".
3. A remote controller can be used to change airflow rate of "H", "M" and "L".
4. Set the ESP on suction side to 0.4in.WG(100Pa) or less.
5. Fan characteristics② (for field setting of remote controller) shows fan characteristics of airflow "H" which can be changed in the field setting by a remote controller.
6. Select ESP setting in accordance with resistance of the connected duct by using Fan characteristics① and② (Factory setting ESP is 0.2in.WG(50Pa). See installation manual for ESP setting procedure.)
7. The ESP setting of this unit can be changed into 13 levels.
8. The value of Fan characteristics② mentioned in this drawing shows the ESP of rated airflow.

ESP : external static pressure

FDMQ15WVJU9

Fan characteristics ①

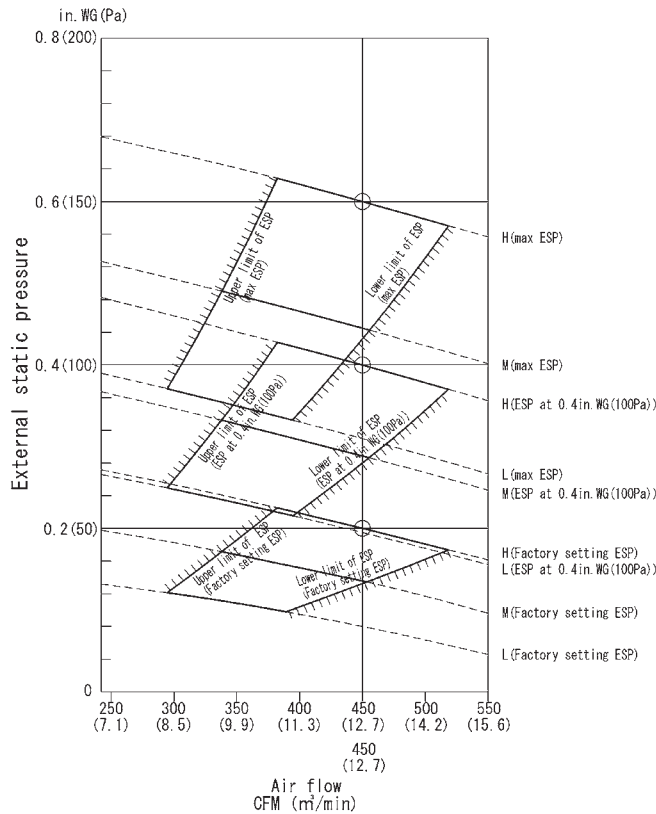

Fan characteristics ②
(For field setting of remote controller)

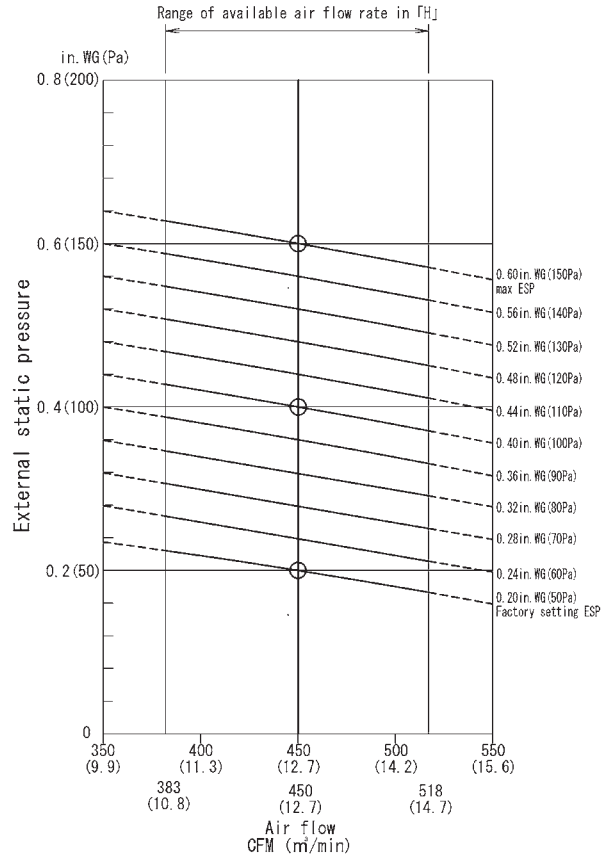

Notes:

1. Fan characteristics at the time of rear suction and bottom suction are similar to each other.
2. Fan characteristics ① shows a representative of fan characteristics at the time of "Maximum ESP", "ESP at 0.4in. WG(100Pa)" and "Factory setting ESP".
3. A remote controller can be used to change air flow rate of "H", "M" and "L".
4. Set the ESP on suction side to 0.4in. WG(100Pa) or less.
5. Fan characteristics ② (for field setting of remote controller) shows fan characteristics of airflow "H" which can be changed in the field setting by a remote controller.
6. Select ESP setting in accordance with resistance of the connected duct by using Fan characteristics ① and ② (Factory setting ESP is 0.2in. WG(50Pa). See installation manual for ESP setting procedure.)
7. The ESP setting of this unit can be changed into 10 levels.
8. The value of Fan characteristics ② mentioned in this drawing shows the ESP of rated airflow.

ESP : external static pressure

FDMQ18WVJU9

Fan characteristics ①

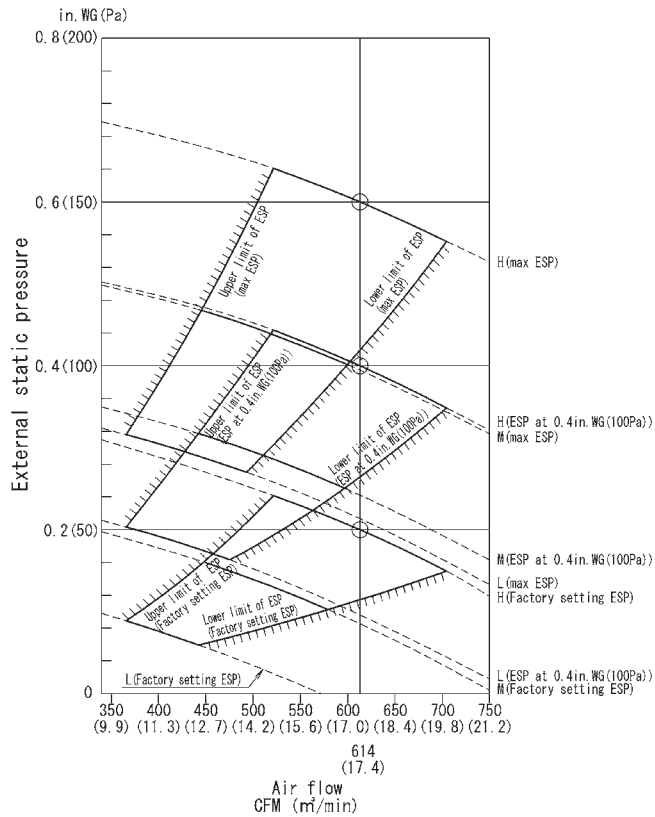

Fan characteristics ②
(For field setting of remote controller)

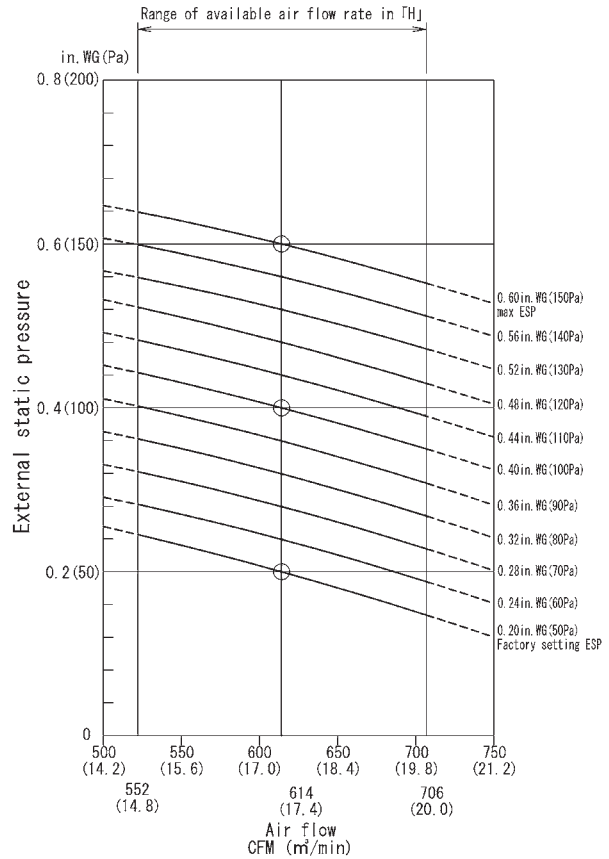

Notes:

1. Fan characteristics at the time of rear suction and bottom suction are similar to each other.
2. Fan characteristics ① shows a representative of fan characteristics at the time of "Maximum ESP", "ESP at 0.4in. WG(100Pa)" and "Factory setting ESP".
3. A remote controller can be used to change airflow rate of "H", "M" and "L".
4. Set the ESP on suction side to 0.4in. WG(100Pa) or less.
5. Fan characteristics ② (for field setting of remote controller) shows fan characteristics of airflow "H" which can be changed in the field setting by a remote controller.
6. Select ESP setting in accordance with resistance of the connected duct by using Fan characteristics ① and ② (Factory setting ESP is 0.2in. WG(50Pa). See installation manual for ESP setting procedure.)
7. The ESP setting of this unit can be changed into 10 levels.
8. The value of Fan characteristics ② mentioned in this drawing shows the ESP of rated airflow.

ESP : external static pressure

FDMQ24WVJU9

Fan characteristics ①

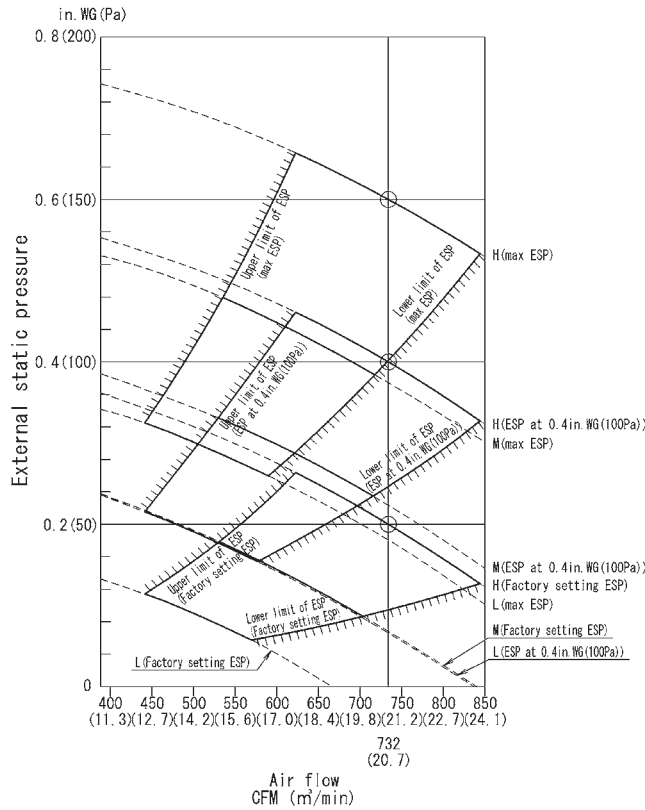

Fan characteristics ②
(For field setting of remote controller)

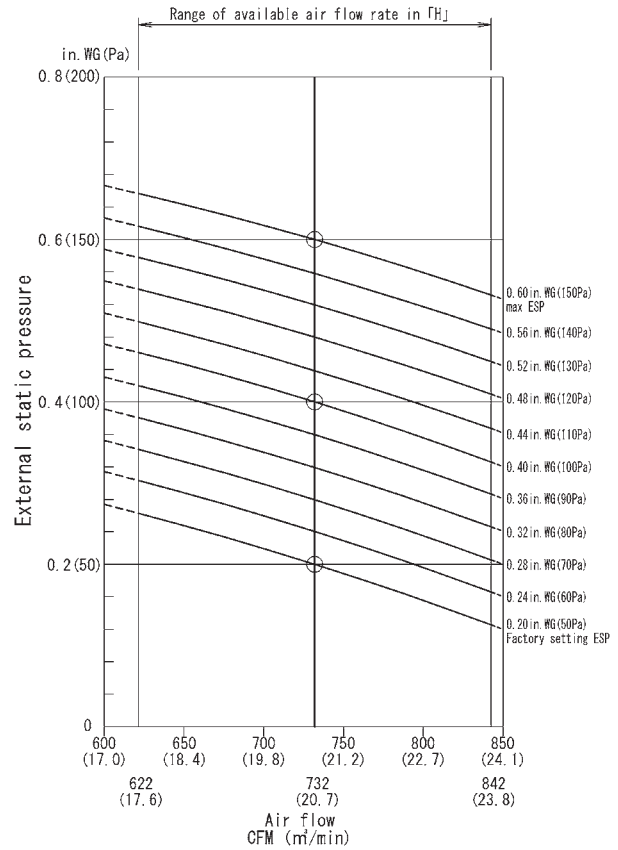

Notes:

1. Fan characteristics at the time of rear suction and bottom suction are similar to each other.
2. Fan characteristics ① shows a representative of fan characteristics at the time of "Maximum ESP", "ESP at 0.4in. WG (100Pa)" and "Factory setting ESP".
3. A remote controller can be used to change airflow rate of "H", "M" and "L".
4. Set the ESP on suction side to 0.4in. WG (100Pa) or less.
5. Fan characteristics ② (for field setting of remote controller) shows fan characteristics of airflow "H" which can be changed in the field setting by a remote controller.
6. Select ESP setting in accordance with resistance of the connected duct by using Fan characteristics ① and ② (Factory setting ESP is 0.2in. WG (50Pa). See installation manual for ESP setting procedure.)
7. The ESP setting of this unit can be changed into 10 levels.
8. The value of Fan characteristics ② mentioned in this drawing shows the ESP of rated airflow.

ESP : external static pressure

9.2 Airflow Auto Adjustment CDMQ07WVJU9

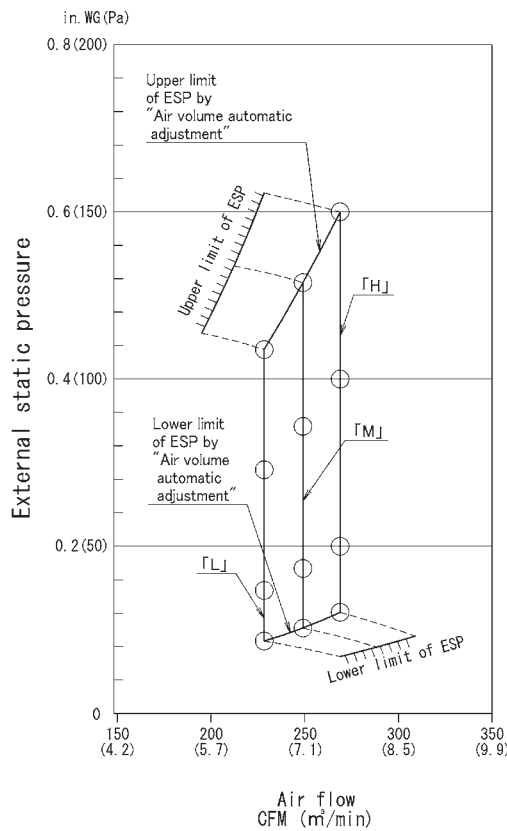

Notes :

1. This indoor unit has the "Air volume automatic adjustment" function, which automatically adjusts the air flow rate so as to be approximately in the range of $\pm 10\%$ of the rated value, at the time of installation.
2. After duct construction completion, please perform field setting "Air volume automatic adjustment" by remote controller.
3. About the field setting method of the "Air volume automatic adjustment", look at the installation manual which is attached to an indoor unit.
4. ESP that can adjust by "Air volume automatic adjustment" function is 0.12in.WG (30Pa) - 0.6in.WG(150Pa) (When air flow is "H").
5. If the unit is used beyond the range of the above-mentioned ESP, the air flow rate can not be well-adjusted automatically, and the unit will operate with the air flow rate different from the rated value.
6. This figure shows a fan characteristics at the time of "H" "M" and "L".
7. The remote controller can be used to change "H" "M" and "L".

ESP : external static pressure.

3D141700

FDMQ09WVJU9

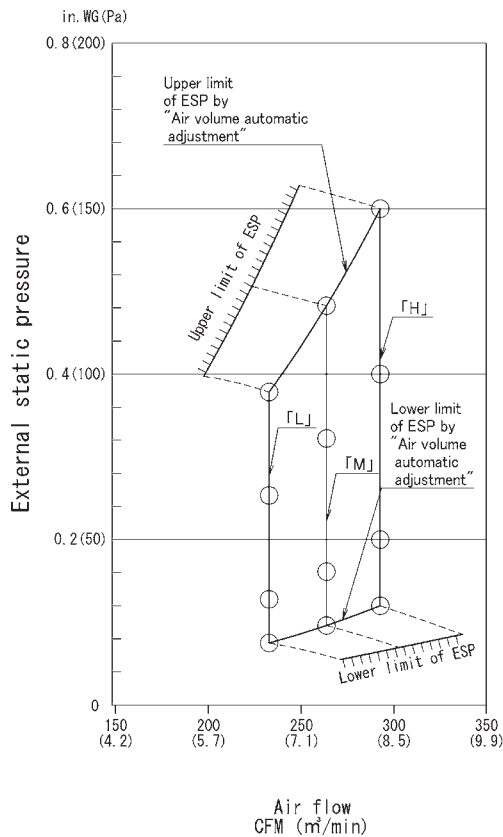

Notes :

1. This indoor unit has the "Air volume automatic adjustment" function, which automatically adjusts the air flow rate so as to be approximately in the range of $\pm 10\%$ of the rated value, at the time of installation.
2. After duct construction completion, please perform field setting "Air volume automatic adjustment" by remote controller.
3. About the field setting method of the "Air volume automatic adjustment", look at the installation manual which is attached to an indoor unit.
4. ESP that can adjust by "Air volume automatic adjustment" function is 0.12in.WG (30Pa) - 0.6in.WG(150Pa) (When air flow is "H").
5. If the unit is used beyond the range of the above-mentioned ESP, the air flow rate can not be well-adjusted automatically, and the unit will operate with the air flow rate different from the rated value.
6. This figure shows a fan characteristics at the time of "H" "M" and "L".
7. The remote controller can be used to change "H" "M" and "L".

ESP : external static pressure.

3D141701

FDMQ12WVJU9

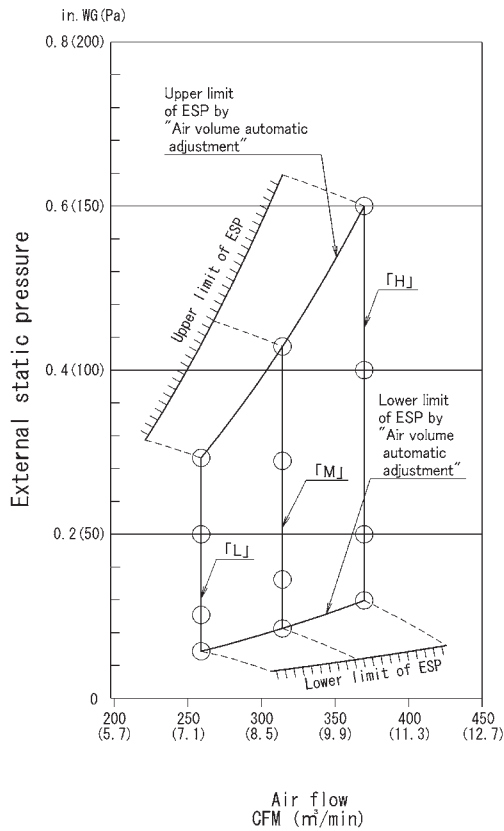

Notes :

1. This indoor unit has the "Air volume automatic adjustment" function, which automatically adjusts the air flow rate so as to be approximately in the range of ±10% of the rated value, at the time of installation.
2. After duct construction completion, please perform field setting "Air volume automatic adjustment" by remote controller.
3. About the field setting method of the "Air volume automatic adjustment", look at the installation manual which is attached to an indoor unit.
4. ESP that can adjust by "Air volume automatic adjustment" function is 0.12in.WG (30Pa) - 0.6in.WG(150Pa) (When air flow is "H").
5. If the unit is used beyond the range of the above-mentioned ESP, the air flow rate can not be well-adjusted automatically, and the unit will operate with the air flow rate different from the rated value.
6. This figure shows a fan characteristics at the time of "H" "M" and "L".
7. The remote controller can be used to change "H" "M" and "L".

ESP : external static pressure.

3D141702

FDMQ15WVJU9

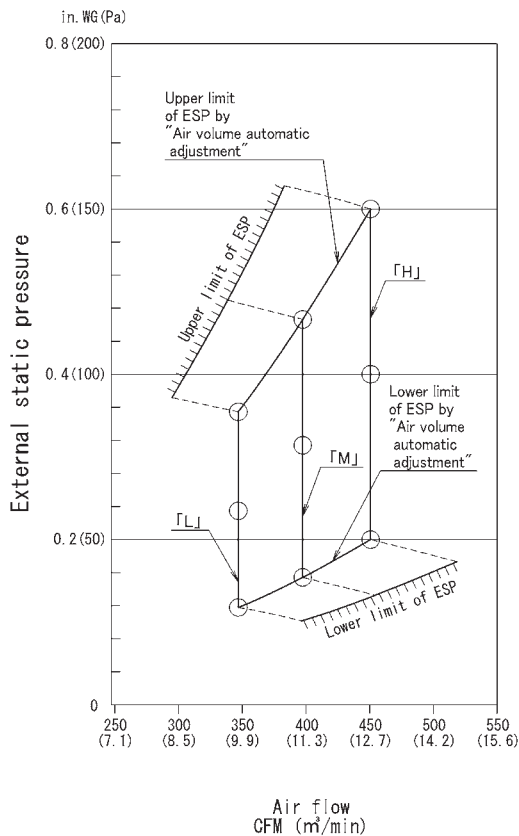

Notes :

1. This indoor unit has the "Air volume automatic adjustment" function, which automatically adjusts the air flow rate so as to be approximately in the range of ±10% of the rated value, at the time of installation.
2. After duct construction completion, please perform field setting "Air volume automatic adjustment" by remote controller.
3. About the field setting method of the "Air volume automatic adjustment", look at the installation manual which is attached to an indoor unit.
4. ESP that can adjust by "Air volume automatic adjustment" function is 0.2in.WG (50Pa) - 0.6in.WG (150Pa) (When air flow is "H").
5. If the unit is used beyond the range of the above-mentioned ESP, the air flow rate can not be well-adjusted automatically, and the unit will operate with the air flow rate different from the rated value.
6. This figure shows a fan characteristics at the time of "H" "M" and "L".
7. The remote controller can be used to change "H" "M" and "L".

ESP : external static pressure.

3D141703

FDMQ18WVJU9

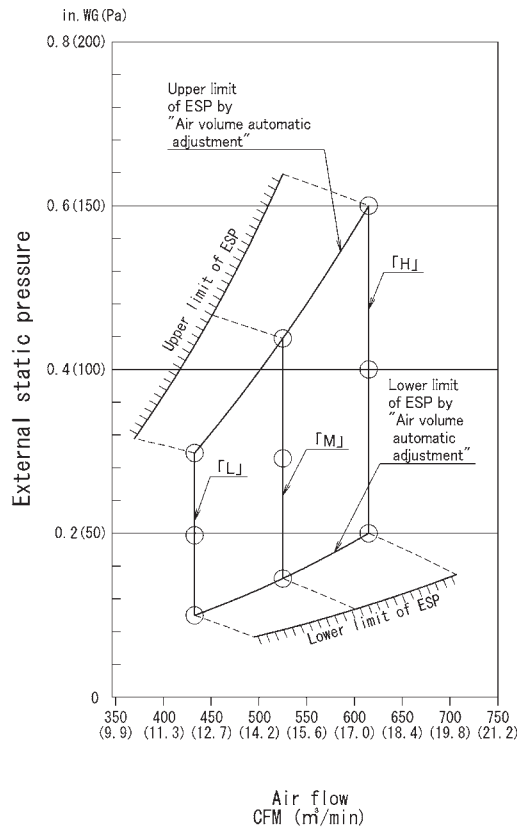

Notes :

1. This indoor unit has the "Air volume automatic adjustment" function, which automatically adjusts the air flow rate so as to be approximately in the range of $\pm 10\%$ of the rated value, at the time of installation.
2. After duct construction completion, please perform field setting "Air volume automatic adjustment" by remote controller.
3. About the field setting method of the "Air volume automatic adjustment", look at the installation manual which is attached to an indoor unit.
4. ESP that can adjust by "Air volume automatic adjustment" function is 0.2in.WG (50Pa) - 0.6in.WG(150Pa) (When air flow is "H").
5. If the unit is used beyond the range of the above-mentioned ESP, the air flow rate can not be well-adjusted automatically, and the unit will operate with the air flow rate different from the rated value.
6. This figure shows a fan characteristics at the time of "H" "M" and "L".
7. The remote controller can be used to change "H" "M" and "L".

ESP : external static pressure.

3D141704

FDMQ24WVJU9

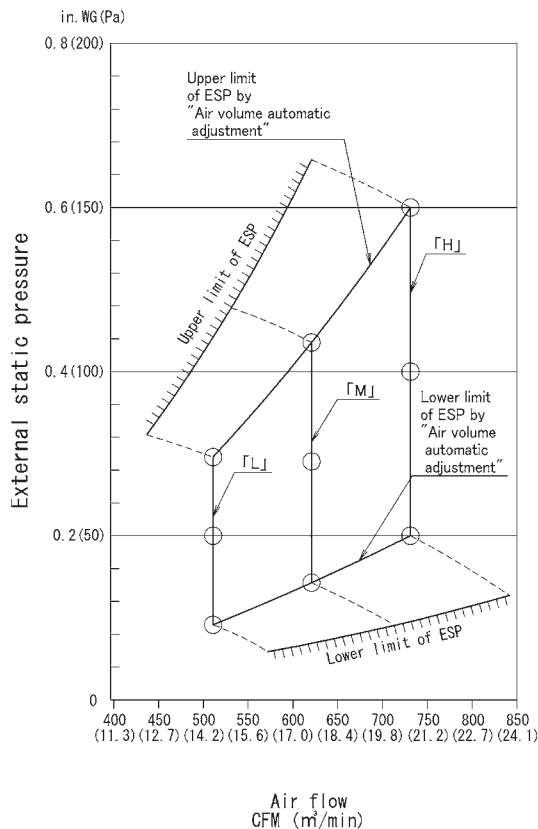

Notes :

1. This indoor unit has the "Air volume automatic adjustment" function, which automatically adjusts the air flow rate so as to be approximately in the range of $\pm 10\%$ of the rated value, at the time of installation.
2. After duct construction completion, please perform field setting "Air volume automatic adjustment" by remote controller.
3. About the field setting method of the "Air volume automatic adjustment", look at the installation manual which is attached to an indoor unit.
4. ESP that can adjust by "Air volume automatic adjustment" function is 0.2in.WG (50Pa) - 0.6in.WG(150Pa) (When air flow is "H").
5. If the unit is used beyond the range of the above-mentioned ESP, the air flow rate can not be well-adjusted automatically, and the unit will operate with the air flow rate different from the rated value.
6. This figure shows a fan characteristics at the time of "H" "M" and "L".
7. The remote controller can be used to change "H" "M" and "L".

ESP : external static pressure.

3D141705

10 Sound Level

10.1 Measuring Location

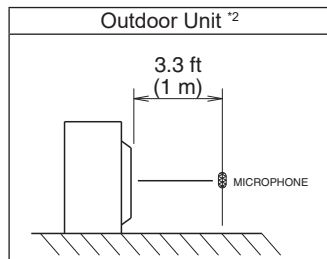
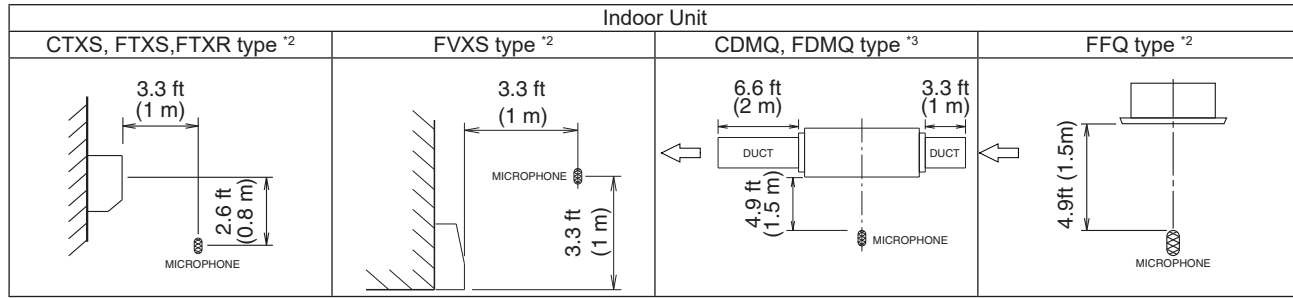

- Notes:**
1. Operation sound is measured in an anechoic chamber.
 2. The operation sound measuring method is based on JIS standard.
 3. The data are based on the conditions shown in the table below.

Cooling	Heating
Indoor ; 80°FDB (26.7°CDB) / 67°FWB (19.4°CWB) Outdoor ; 95°FDB (35°CDB) / 75°FWB (23.9°CWB)	Indoor ; 70°FDB (21.1°CDB) / 60°FWB (15.6°CWB) Outdoor ; 47°FDB (8.3°CDB) / 43°FWB (6.1°CWB)

10.2 Indoor unit CTXS07WVJU9

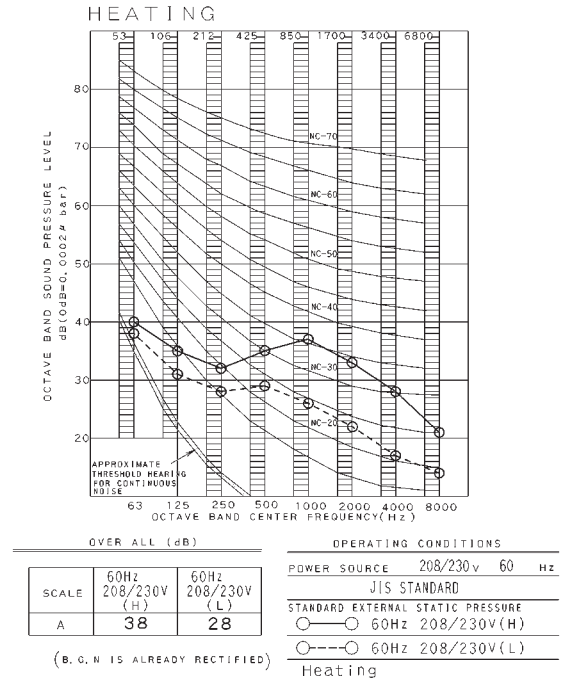
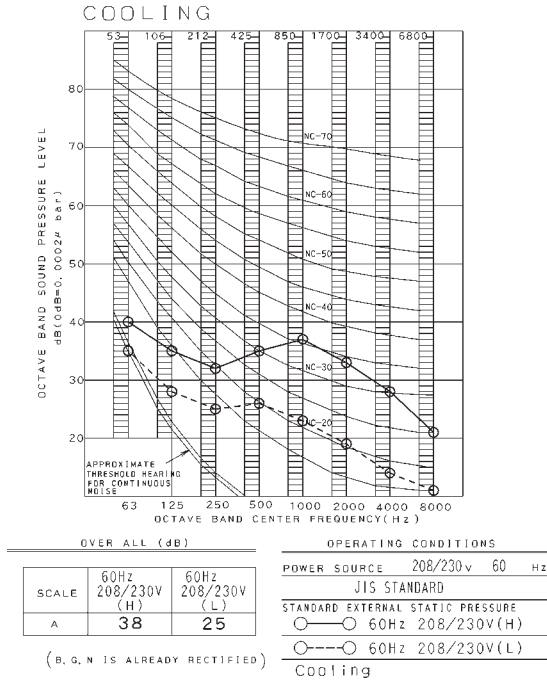

3D075359A

FTXS09WVJU9

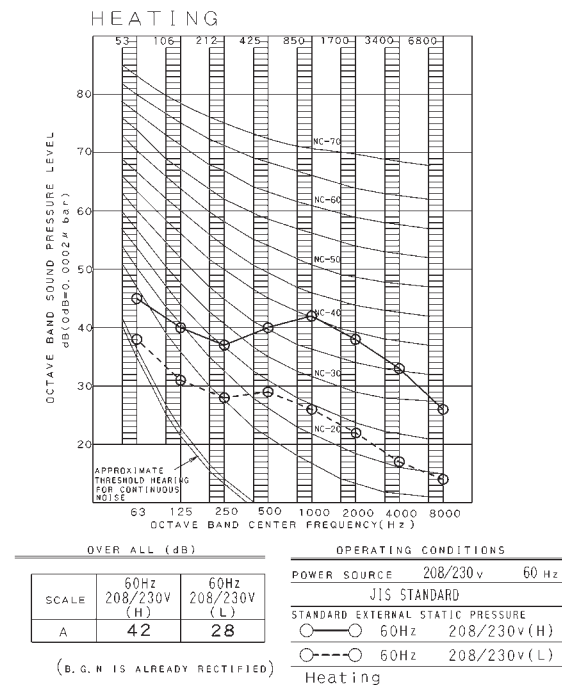
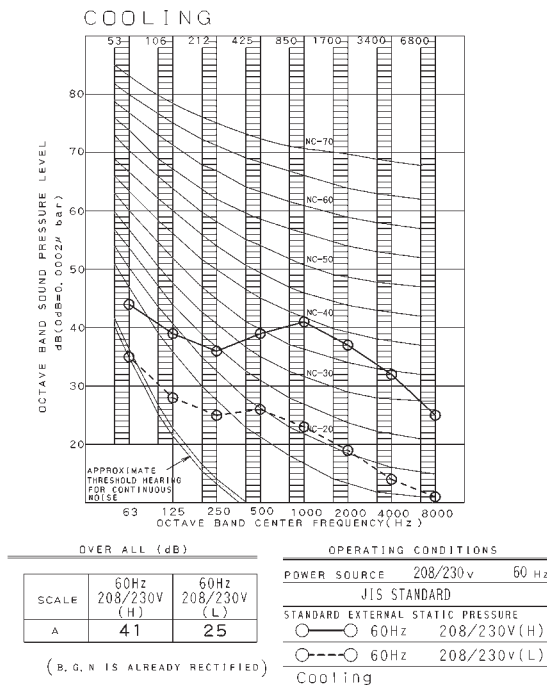

3D075355A

FTXS12WVJU9

COOLING

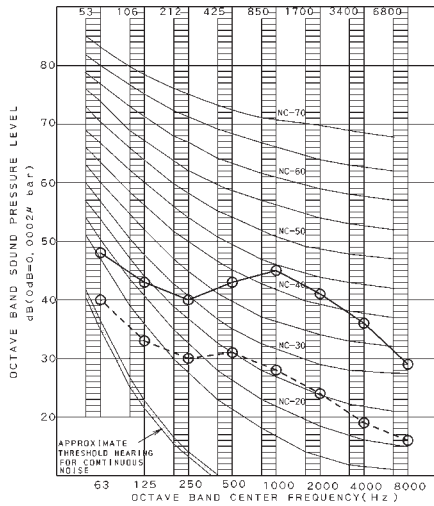

OVER ALL (dB)

SCALE	60Hz	60Hz
	208/230V (H)	208/230V (L)
A	45	29

(B, G, N IS ALREADY RECTIFIED)

OPERATING CONDITIONS

POWER SOURCE 208/230 v 60 Hz
 JIS STANDARD
 STANDARD EXTERNAL STATIC PRESSURE
 ○—○ 60Hz 208/230V(H)
 ○---○ 60Hz 208/230V(L)
 Cooling

HEATING

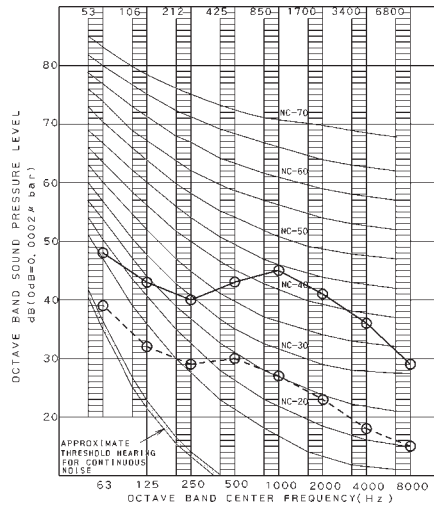

OVER ALL (dB)

SCALE	60Hz	60Hz
	208/230V (H)	208/230V (L)
A	45	29

(B, G, N IS ALREADY RECTIFIED)

OPERATING CONDITIONS

POWER SOURCE 208/230 v 60 Hz
 JIS STANDARD
 STANDARD EXTERNAL STATIC PRESSURE
 ○—○ 60Hz 208/230V(H)
 ○---○ 60Hz 208/230V(L)
 Heating

3D075356A

FTXS15WVJU9

COOLING

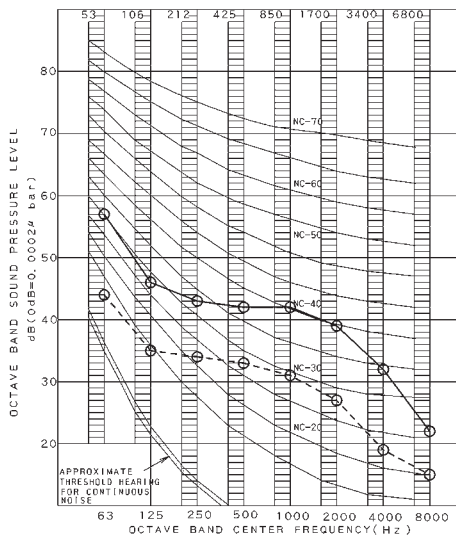

OVER ALL (dB)

SCALE	60Hz	60Hz
	208/230V (H)	208/230V (L)
A	45	35

(B, G, N IS ALREADY RECTIFIED)

OPERATING CONDITIONS

POWER SOURCE 208/230 v 60 Hz
 JIS STANDARD
 ○—○ 60Hz 208/230V(H)
 ○---○ 60Hz 208/230V(L)
 Cooling

HEATING

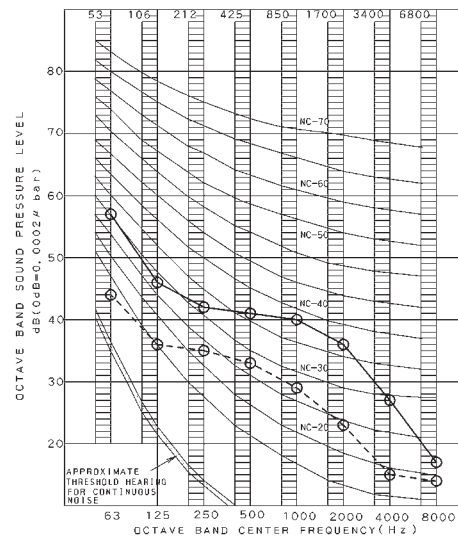

OVER ALL (dB)

SCALE	60Hz	60Hz
	208/230V (H)	208/230V (L)
A	43	33

(B, G, N IS ALREADY RECTIFIED)

OPERATING CONDITIONS

POWER SOURCE 208/230 v 60 Hz
 JIS STANDARD
 ○—○ 60Hz 208/230V(H)
 ○---○ 60Hz 208/230V(L)
 Heating

3D074864A

FTXS18WVJU9

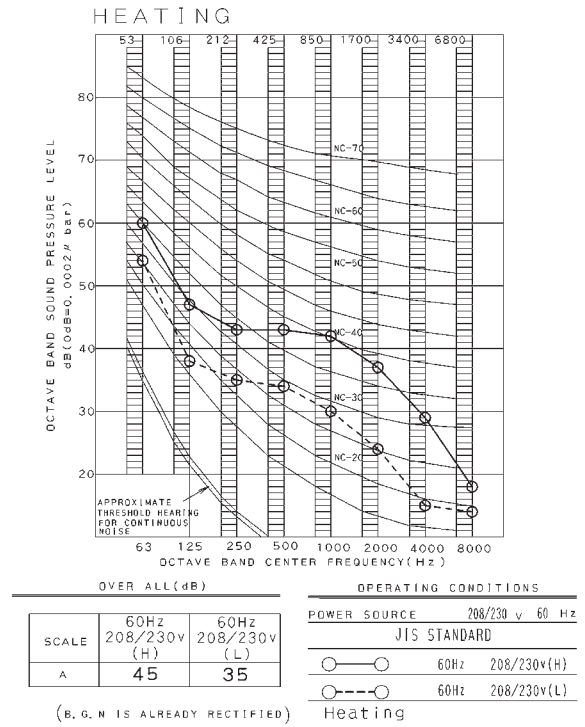
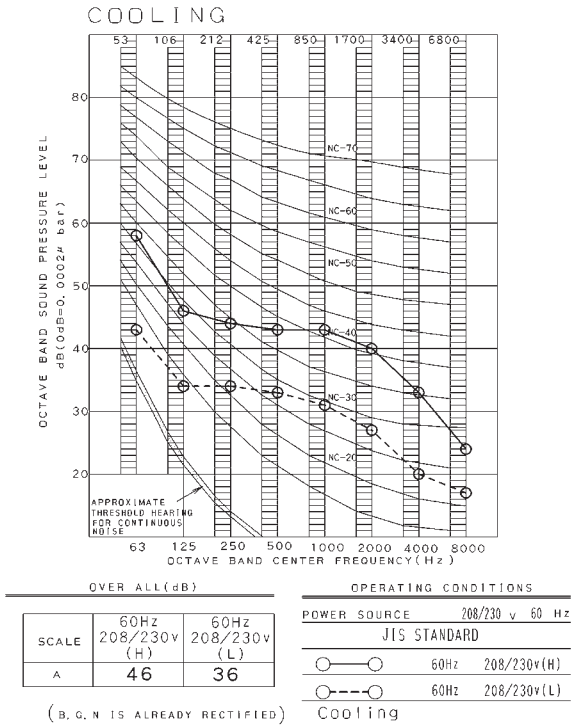

3D074865A

FTXS24WVJU9

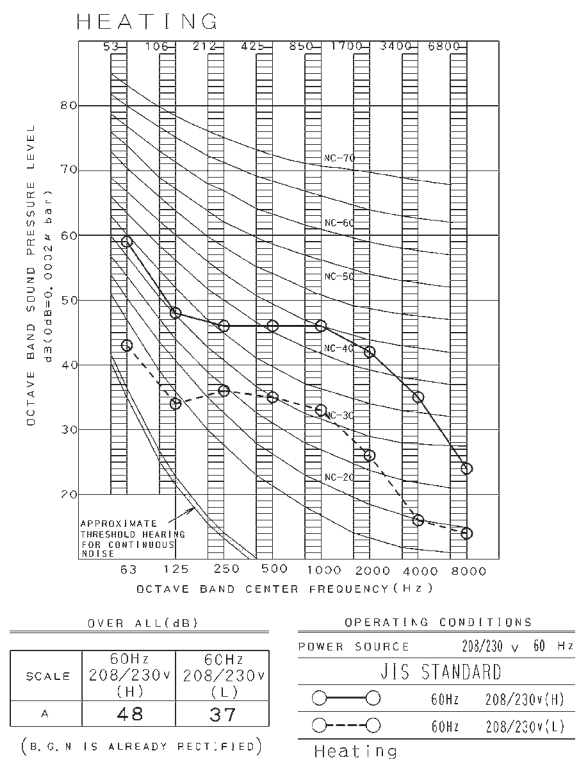
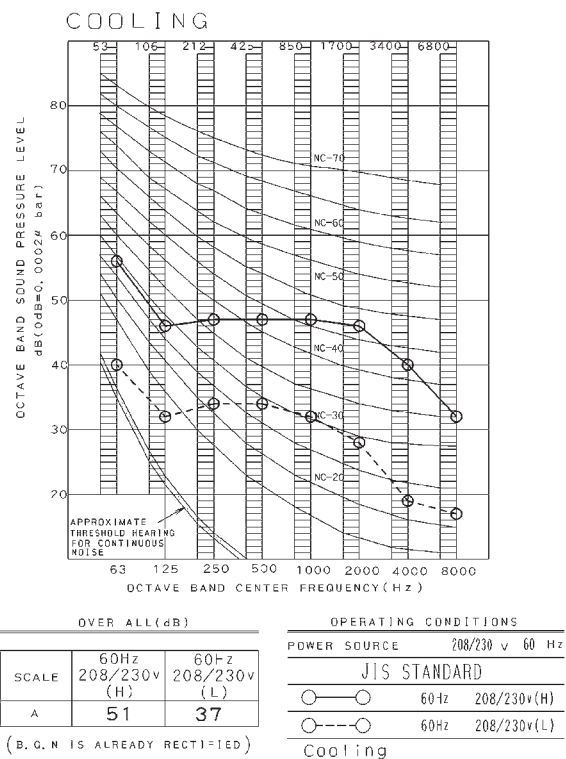

3D074866A

FTXR09WVJUW(S)9

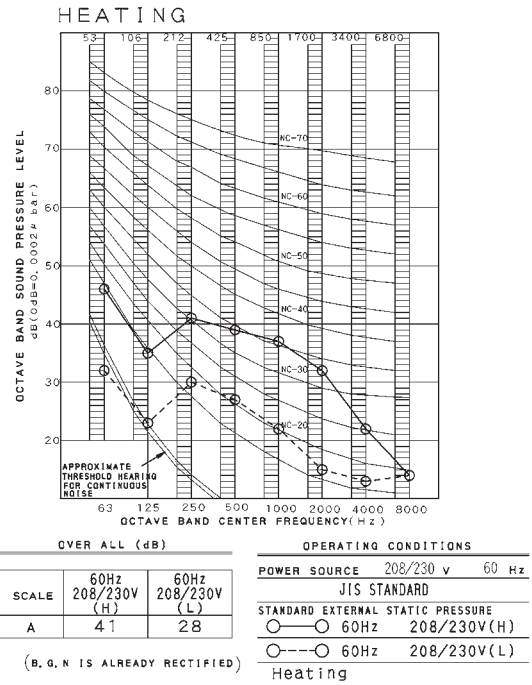
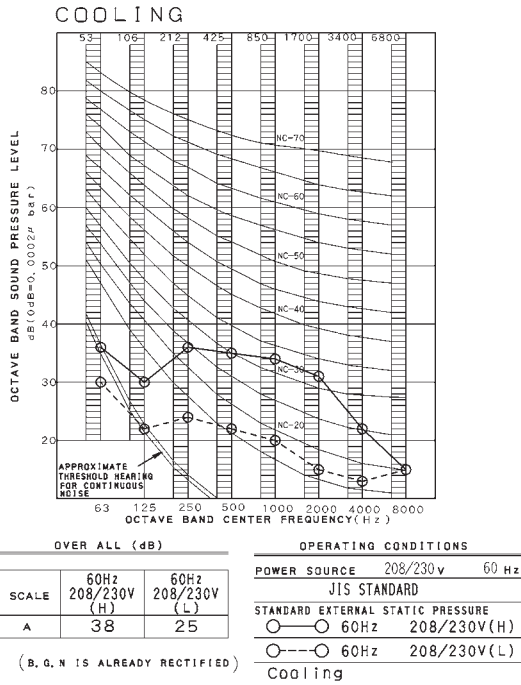

3D105687B

FTXR12WVJUW(S)9

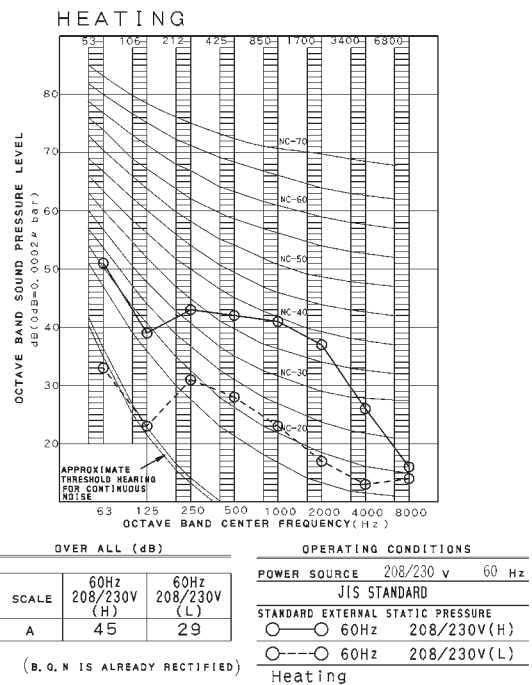
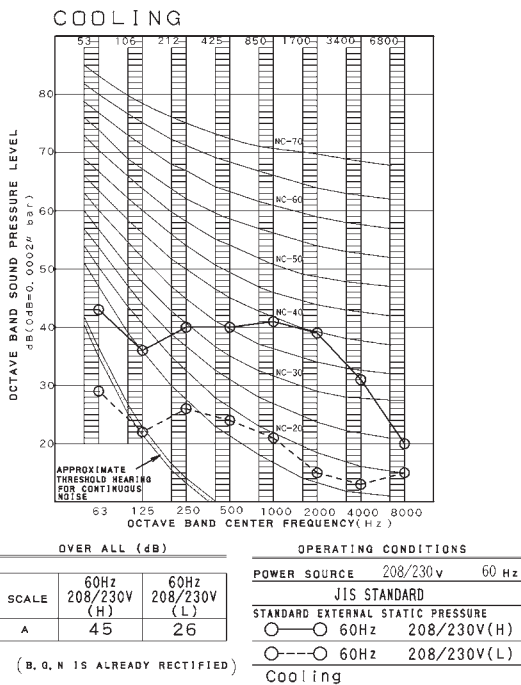

3D105688B

FTXR18WVJUW(S)9

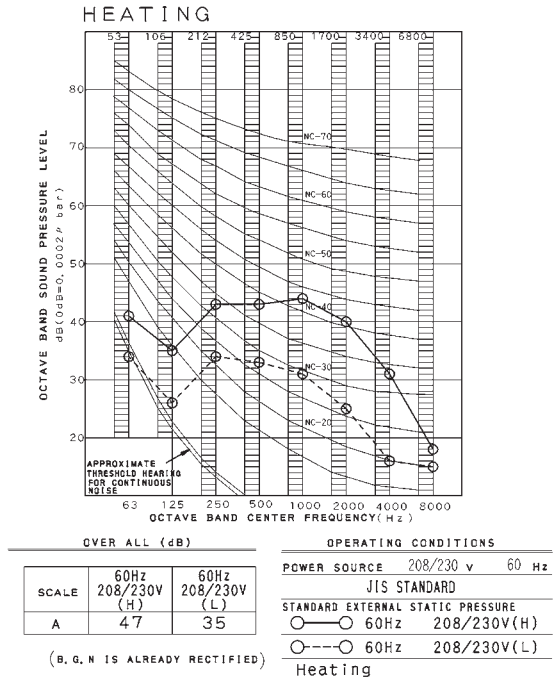
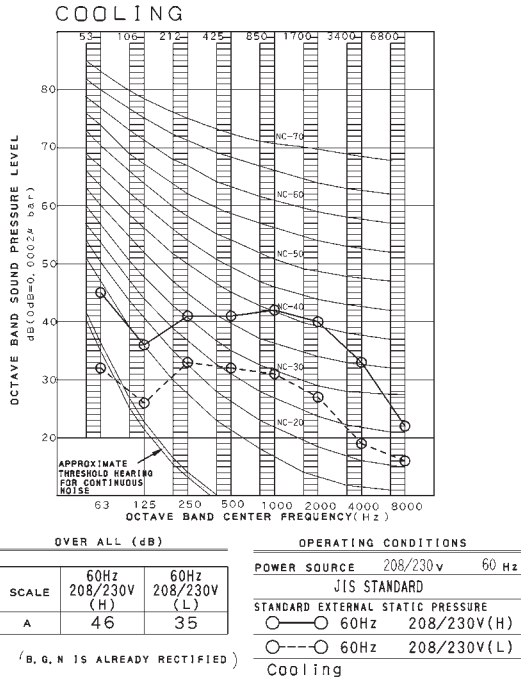

3D105689B

FVXS09WVJU9

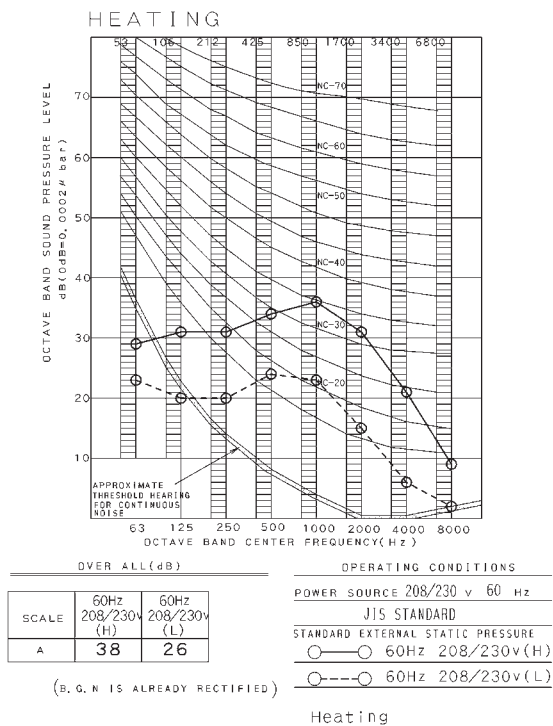
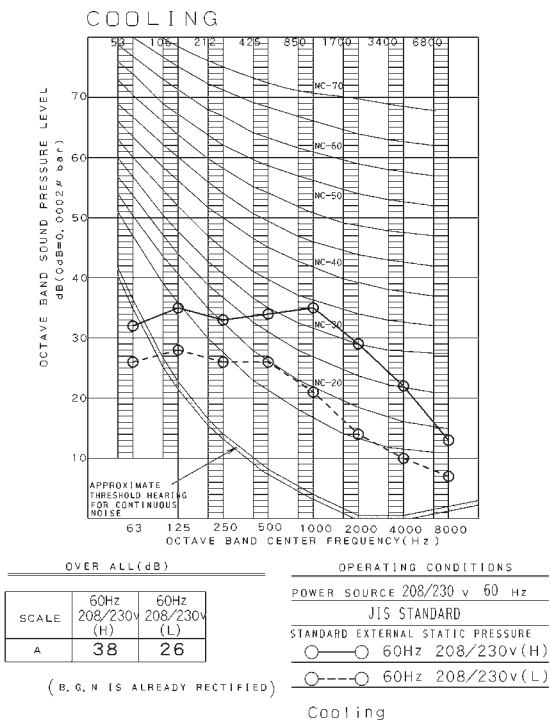

3D094737A

FVXS12WVJU9

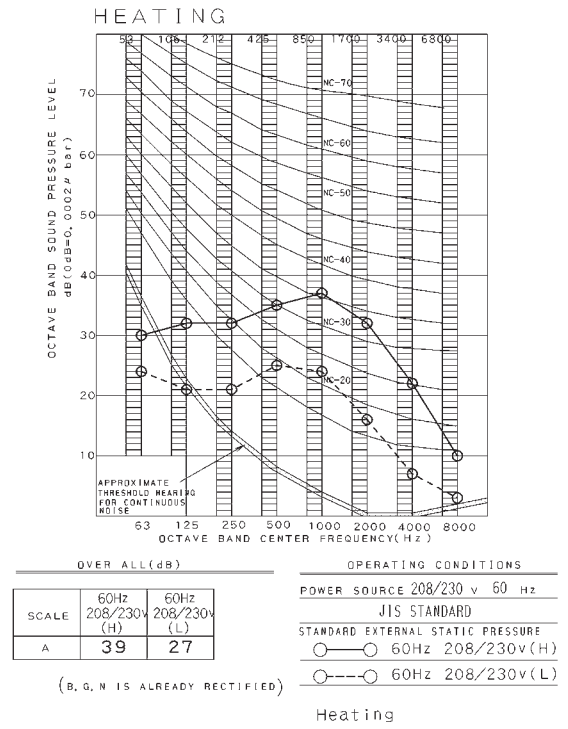
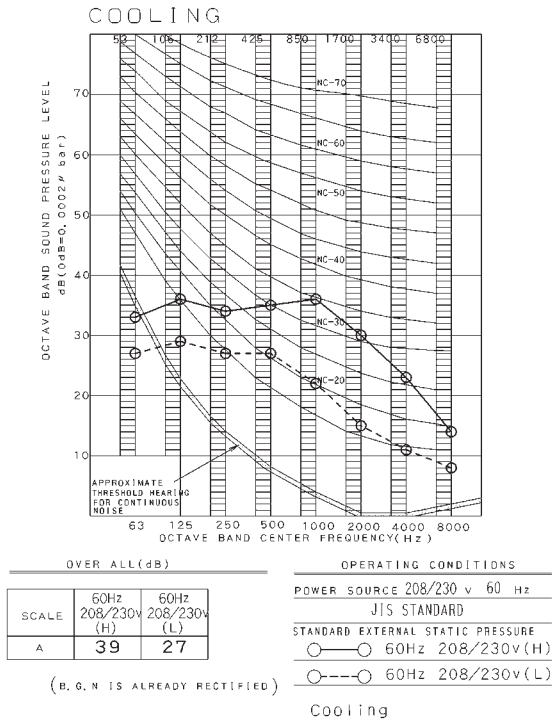

3D094766A

FVXS15/18WVJU9

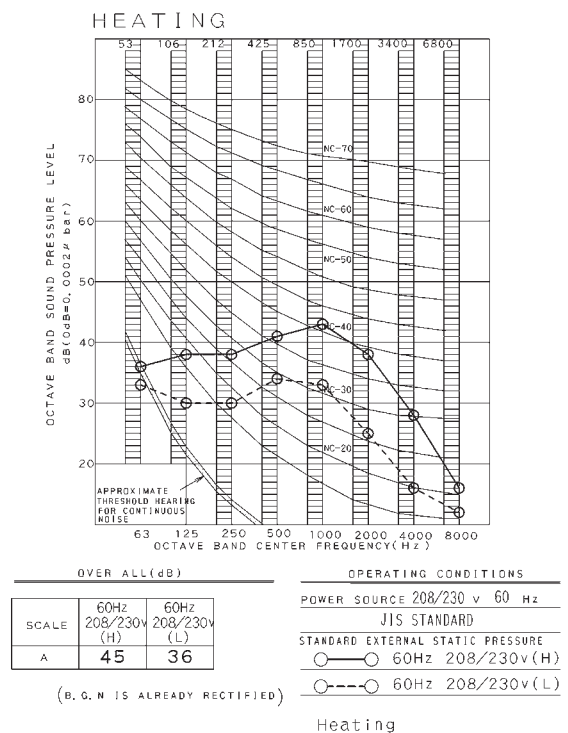
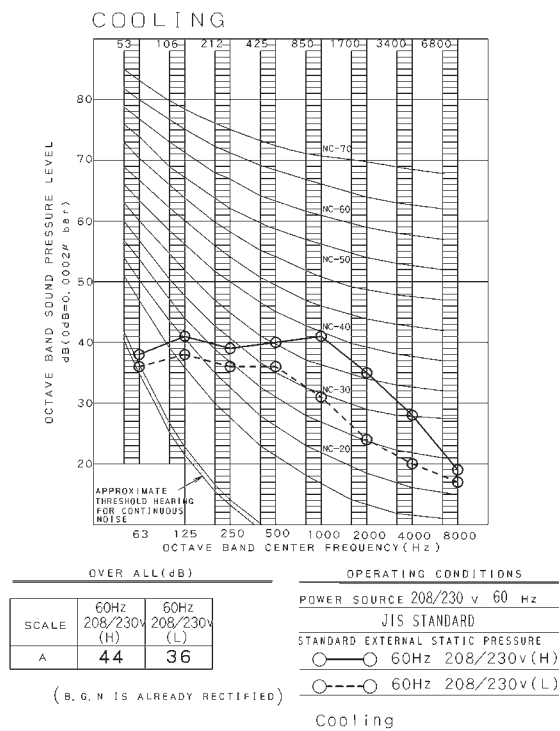

3D094777B

CDMQ07WVJU9

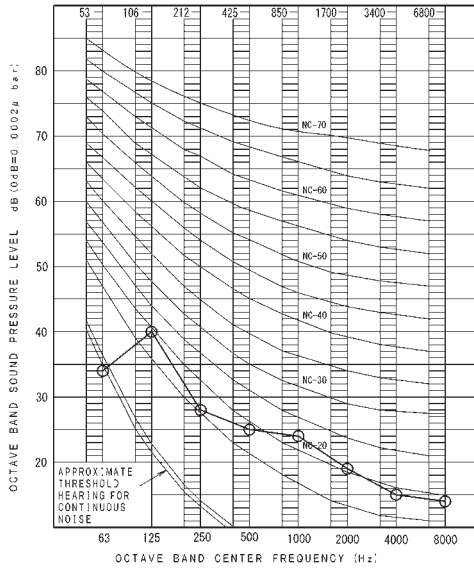

OVER ALL (dB) AIR FLOW RATE
 SCALE H
 A 30.0
 (B.G.N IS ALREADY RECTIFIED)

OPERATING CONDITIONS
 POWER SOURCE 208/230V 60Hz
 COOLING RETURN AIR TEMPERATURE : 80.0 ° F (26.7 ° C) DB 67.0 ° F (19.4 ° C) WB
 OUTDOOR TEMPERATURE : 95.0 ° F (35.0 ° C) DB 75.0 ° F (23.9 ° C) WB
 HEATING RETURN AIR TEMPERATURE : 70.0 ° F (21.1 ° C) DB 60.0 ° F (15.6 ° C) WB
 OUTDOOR TEMPERATURE : 47.0 ° F (8.3 ° C) DB 43.0 ° F (6.1 ° C) WB

4D141028

FDMQ09WVJU9

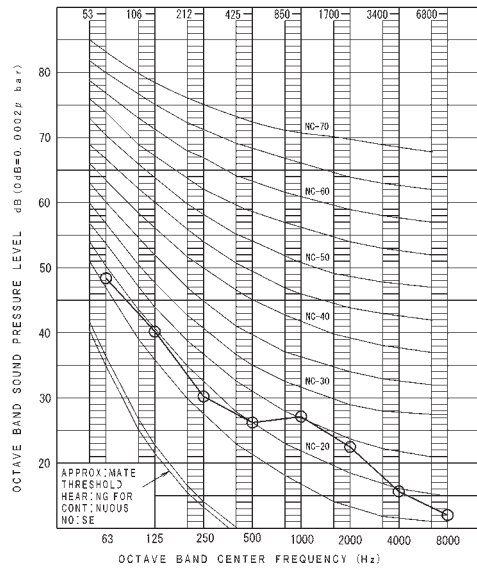

OVER ALL (dB) AIR FLOW RATE
 SCALE H
 A 32.0
 (B.G.N IS ALREADY RECTIFIED)

OPERATING CONDITIONS
 POWER SOURCE 208/230V 60Hz
 COOLING RETURN AIR TEMPERATURE : 80.0 ° F (26.7 ° C) DB 67.0 ° F (19.4 ° C) WB
 OUTDOOR TEMPERATURE : 95.0 ° F (35.0 ° C) DB 75.0 ° F (23.9 ° C) WB
 HEATING RETURN AIR TEMPERATURE : 70.0 ° F (21.1 ° C) DB 60.0 ° F (15.6 ° C) WB
 OUTDOOR TEMPERATURE : 47.0 ° F (8.3 ° C) DB 43.0 ° F (6.1 ° C) WB

4D113009B

FDMQ12WVJU9

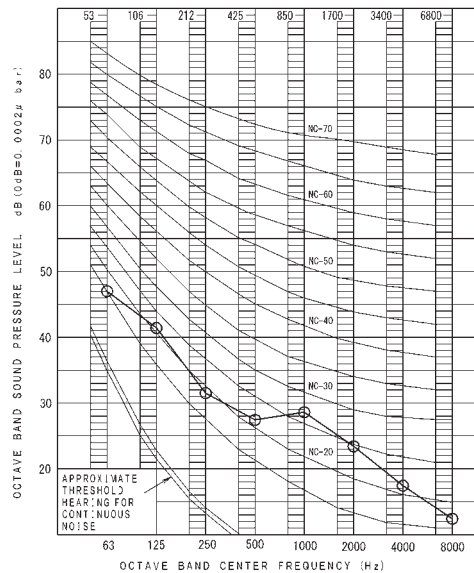

OVER ALL (dB) AIR FLOW RATE
 SCALE H
 A 33.0
 (B.G.N IS ALREADY RECTIFIED)

OPERATING CONDITIONS
 POWER SOURCE 208/230V 60Hz
 COOLING RETURN AIR TEMPERATURE : 80.0 ° F (26.7 ° C) DB 67.0 ° F (19.4 ° C) WB
 OUTDOOR TEMPERATURE : 95.0 ° F (35.0 ° C) DB 75.0 ° F (23.9 ° C) WB
 HEATING RETURN AIR TEMPERATURE : 70.0 ° F (21.1 ° C) DB 60.0 ° F (15.6 ° C) WB
 OUTDOOR TEMPERATURE : 47.0 ° F (8.3 ° C) DB 43.0 ° F (6.1 ° C) WB

4D113010B

FDMQ15WVJU9

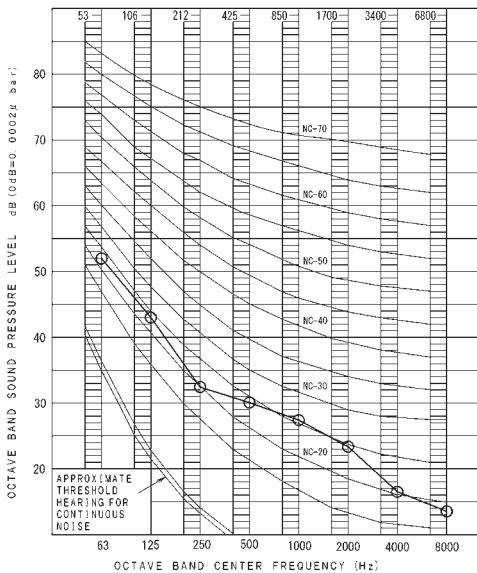

OVER ALL (dB) AIR FLOW RATE
 SCALE H
 A 34.0
 (B.G.N IS ALREADY RECTIFIED)

OPERATING CONDITIONS
 POWER SOURCE 208/230V 60Hz
 COOLING RETURN AIR TEMPERATURE : 80.0 ° F (26.7 ° C) DB 67.0 ° F (19.4 ° C) WB
 OUTDOOR TEMPERATURE : 95.0 ° F (35.0 ° C) DB 75.0 ° F (23.9 ° C) WB
 HEATING RETURN AIR TEMPERATURE : 70.0 ° F (21.1 ° C) DB 60.0 ° F (15.6 ° C) WB
 OUTDOOR TEMPERATURE : 47.0 ° F (8.3 ° C) DB 43.0 ° F (6.1 ° C) WB

4D113011A

FDMQ18WVJU9

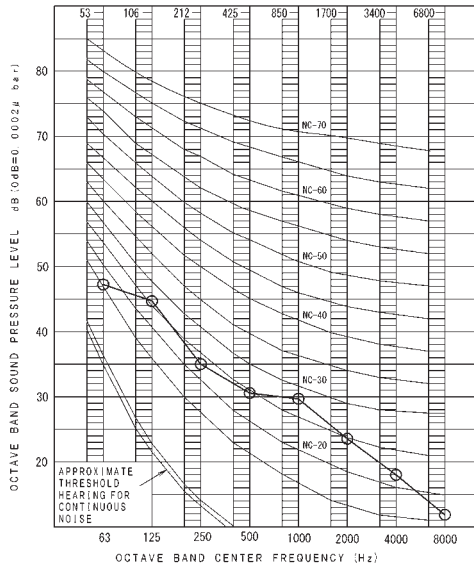

OVER ALL (dB) AIR FLOW RATE
 SCALE H
 A 35.0
 (B. G. N IS ALREADY RECTIFIED)

OPERATING CONDITIONS
 POWER SOURCE 208/230V 60Hz
 COOLING RETURN AIR TEMPERATURE : 80.0 ° F (26.7 ° C) DB 67.0 ° F (19.4 ° C) WB
 OUTDOOR TEMPERATURE : 95.0 ° F (35.0 ° C) DB 75.0 ° F (23.9 ° C) WB
 HEATING RETURN AIR TEMPERATURE : 70.0 ° F (21.1 ° C) DB 60.0 ° F (15.6 ° C) WB
 OUTDOOR TEMPERATURE : 47.0 ° F (8.3 ° C) DB 43.0 ° F (6.1 ° C) WB

FDMQ24WVJU9

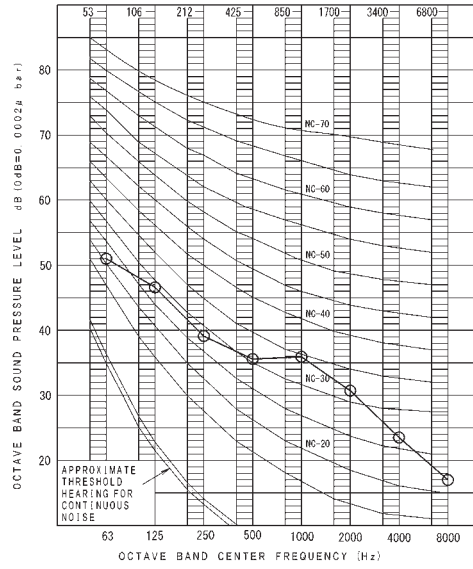

OVER ALL (dB) AIR FLOW RATE
 SCALE H
 A 40.0
 (B. G. N IS ALREADY RECTIFIED)

OPERATING CONDITIONS
 POWER SOURCE 208/230V 60Hz
 COOLING RETURN AIR TEMPERATURE : 80.0 ° F (26.7 ° C) DB 67.0 ° F (19.4 ° C) WB
 OUTDOOR TEMPERATURE : 95.0 ° F (35.0 ° C) DB 75.0 ° F (23.9 ° C) WB
 HEATING RETURN AIR TEMPERATURE : 70.0 ° F (21.1 ° C) DB 60.0 ° F (15.6 ° C) WB
 OUTDOOR TEMPERATURE : 47.0 ° F (8.3 ° C) DB 43.0 ° F (6.1 ° C) WB

4D113012A

4D113013A

FFQ09W2VJU9

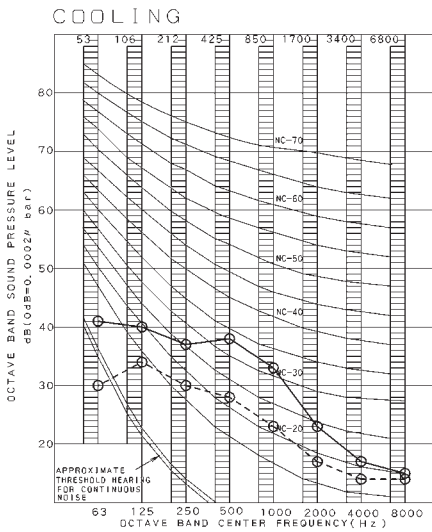

OVER ALL (dB)

SCALE	OPERATING CONDITIONS	
	60Hz 208/230V (H)	60Hz 208/230V (L)
A	38	29

(B, G, N IS ALREADY RECTIFIED)

OPERATING CONDITIONS

POWER SOURCE 208/230v 60 Hz
JIS STANDARD
STANDARD EXTERNAL STATIC PRESSURE
○—○ 60Hz 208/230V(H)
○---○ 60Hz 208/230V(L)
Cooling

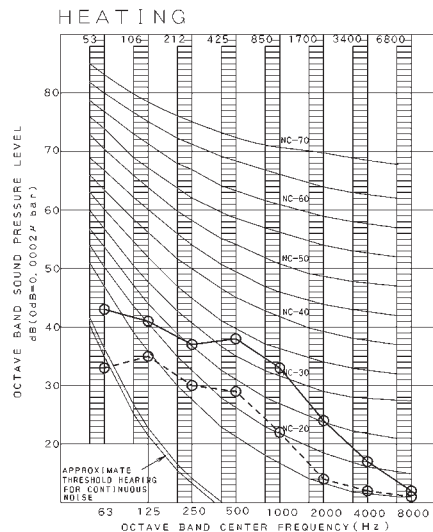

OVER ALL (dB)

SCALE	OPERATING CONDITIONS	
	60Hz 208/230V (H)	60Hz 208/230V (L)
A	38	29

(B, G, N IS ALREADY RECTIFIED)

OPERATING CONDITIONS

POWER SOURCE 208/230 v 60 Hz
JIS STANDARD
STANDARD EXTERNAL STATIC PRESSURE
○—○ 60Hz 208/230V(H)
○---○ 60Hz 208/230V(L)
Heating

3D106125B

FFQ12W2VJU9

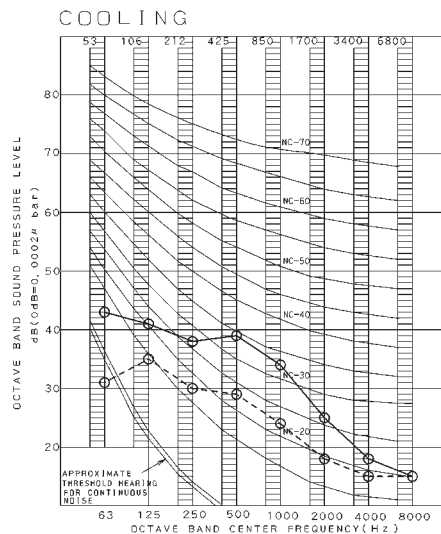

OVER ALL (dB)

SCALE	OPERATING CONDITIONS	
	60Hz 208/230V (H)	60Hz 208/230V (L)
A	39	30

(B, G, N IS ALREADY RECTIFIED)

OPERATING CONDITIONS

POWER SOURCE 208/230v 60 Hz
JIS STANDARD
STANDARD EXTERNAL STATIC PRESSURE
○—○ 60Hz 208/230V(H)
○---○ 60Hz 208/230V(L)
Cooling

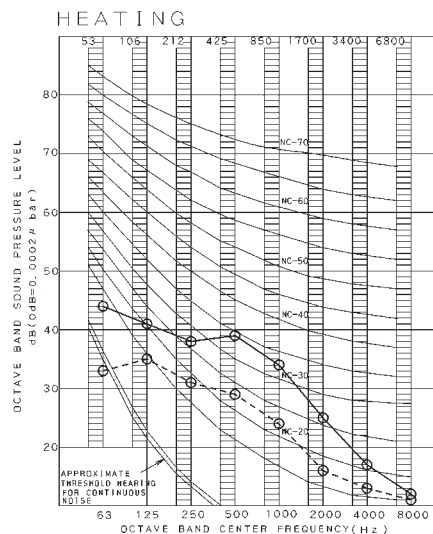

OVER ALL (dB)

SCALE	OPERATING CONDITIONS	
	60Hz 208/230V (H)	60Hz 208/230V (L)
A	39	30

(B, G, N IS ALREADY RECTIFIED)

OPERATING CONDITIONS

POWER SOURCE 208/230 v 60 Hz
JIS STANDARD
STANDARD EXTERNAL STATIC PRESSURE
○—○ 60Hz 208/230V(H)
○---○ 60Hz 208/230V(L)
Heating

3D106126B

FFQ15W2VJU9

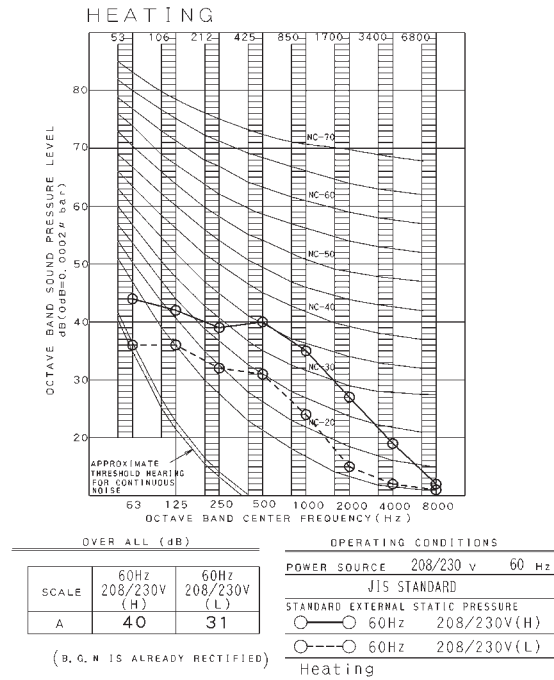
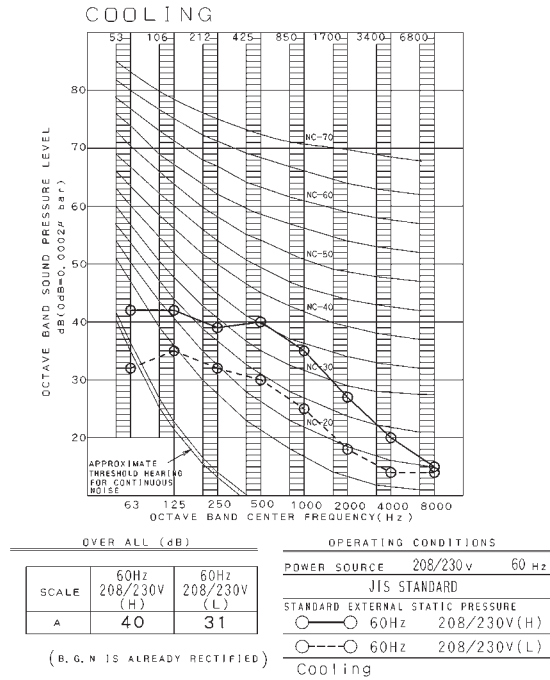

3D106127B

FFQ18W2VJU9

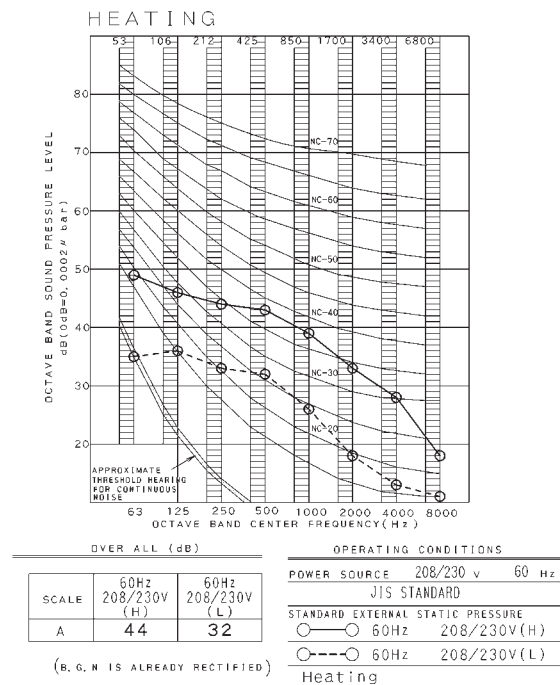
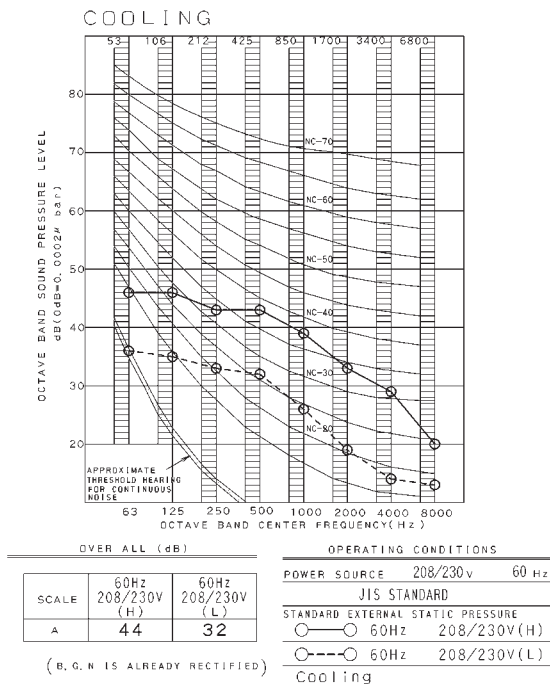

3D108254A

10.3 Outdoor unit 2MXS18WMVJU9

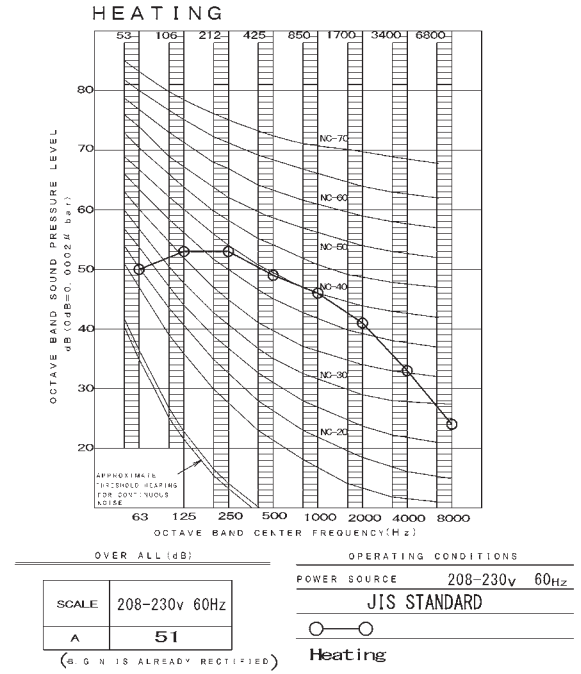
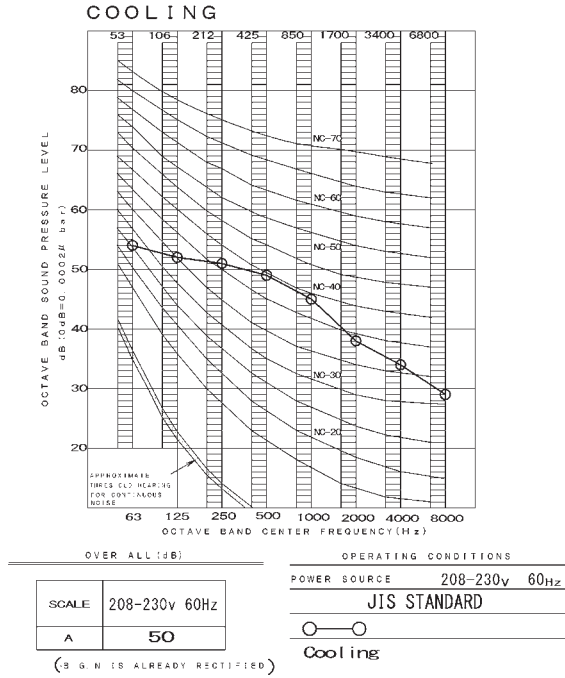

3D093187A

3MXS24WMVJU9

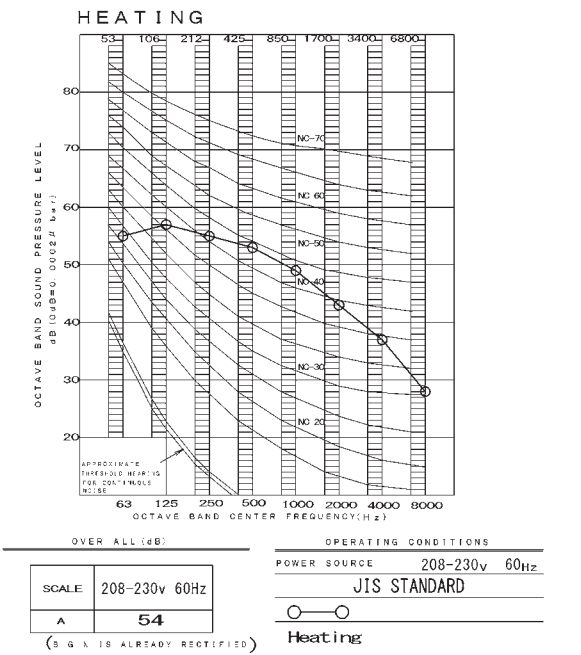
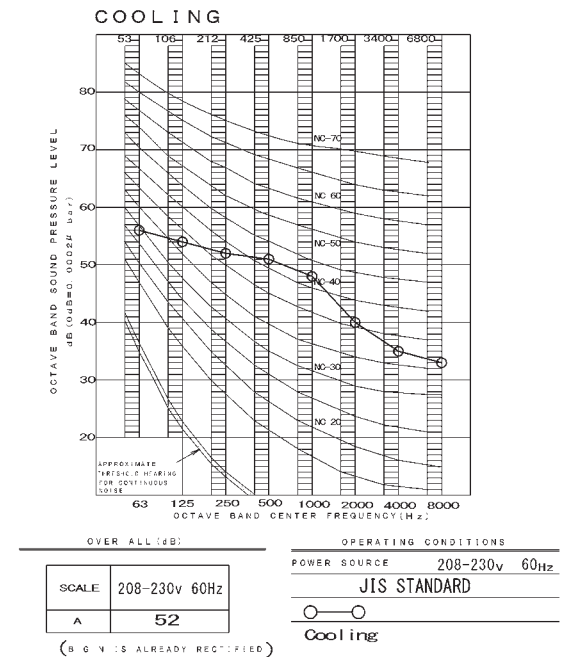

3D093188B

4MXS36WMVJU9

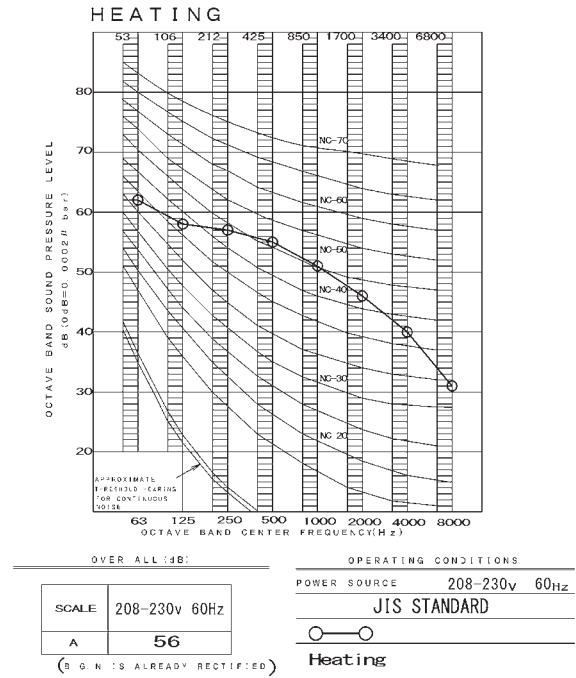
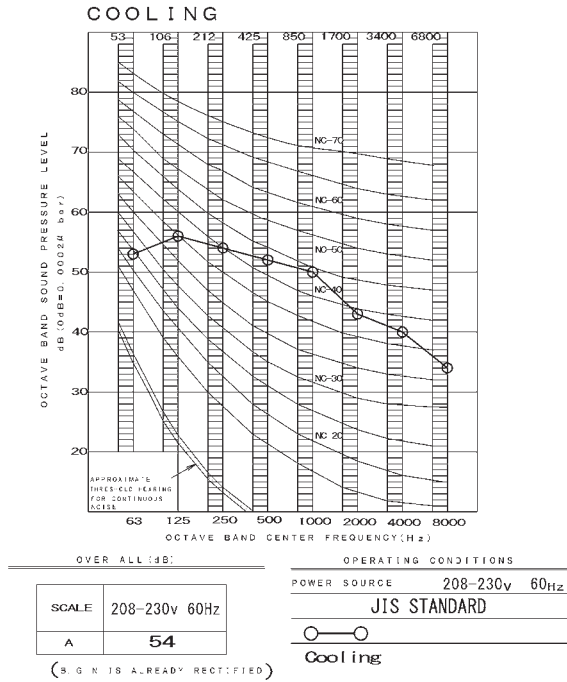

3D093189B

5MXS48WVJU9

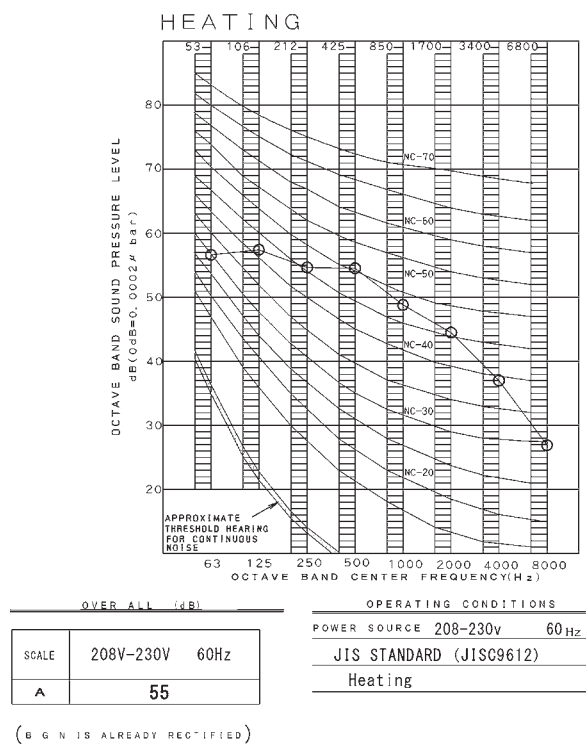
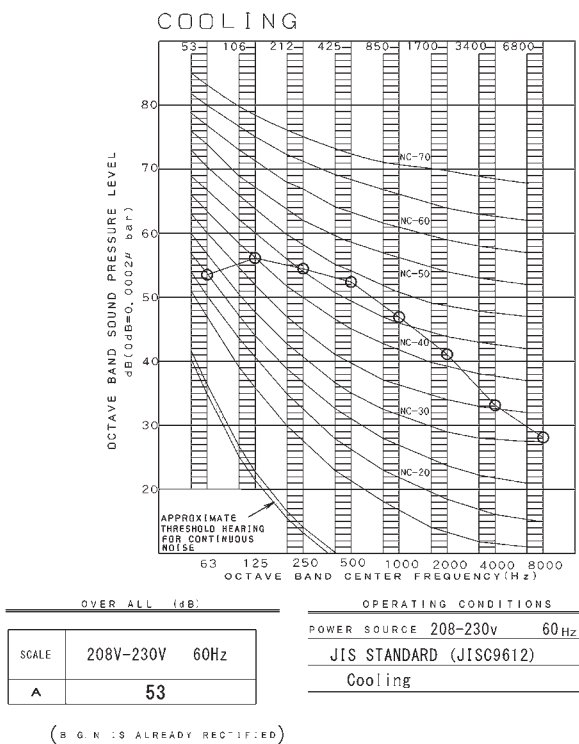

3D118300

2MXL18WMVJU9, 2MXLH18WVJU9

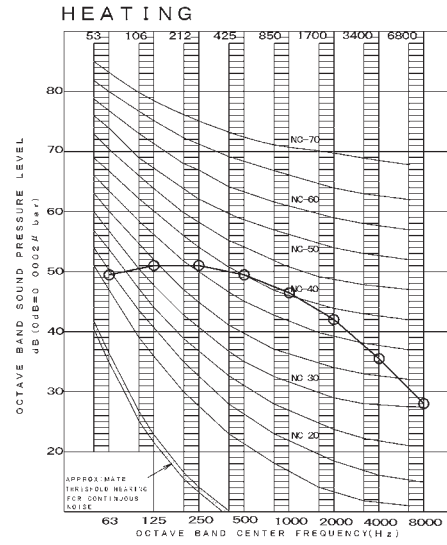
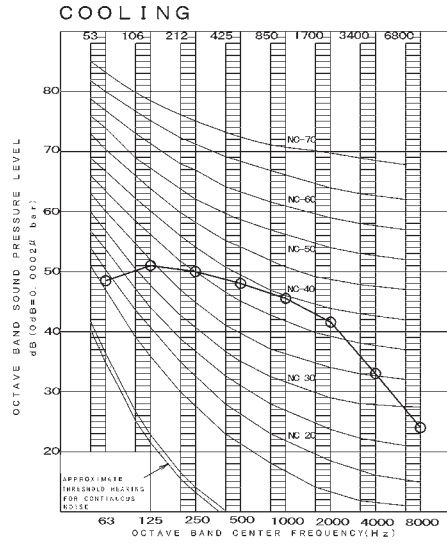

OVER ALL (dB):

SCALE	208-230v 60Hz
A	50

(B.G.N IS ALREADY RECTIFIED)

OPERATING CONDITIONS

POWER SOURCE 208-230v 60Hz

JIS STANDARD

○—○

Cooling

OVER ALL (dB):

SCALE	208-230v 60Hz
A	51

(B.G.N IS ALREADY RECTIFIED)

OPERATING CONDITIONS

POWER SOURCE 208-230v 60Hz

JIS STANDARD

○—○

Heating

3D101086A

3MXL24WMVJU9, 3MXLH24WVJU9

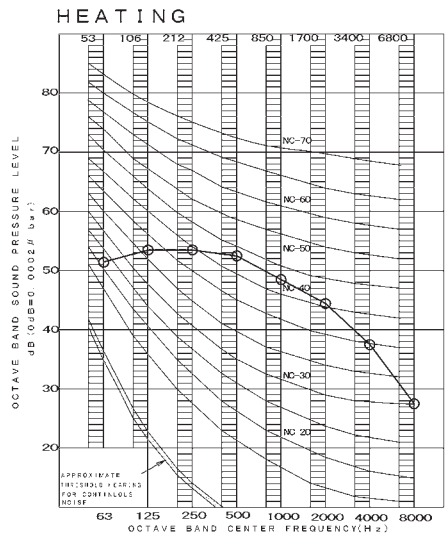
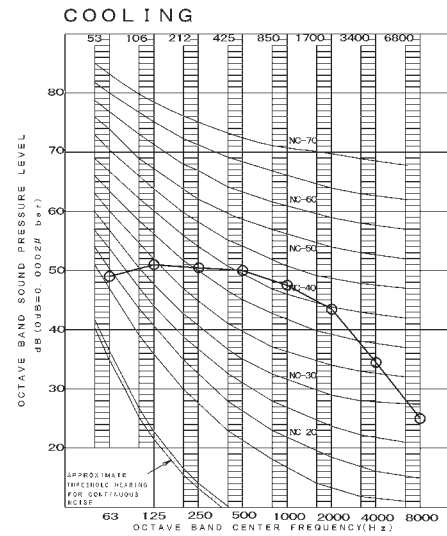

OVER ALL (dB):

SCALE	208-230v 60Hz
A	52

(B.G.N IS ALREADY RECTIFIED)

OPERATING CONDITIONS

POWER SOURCE 208-230v 60Hz

JIS STANDARD

○—○

Cooling

OVER ALL (dB):

SCALE	208-230v 60Hz
A	54

(B.G.N IS ALREADY RECTIFIED)

OPERATING CONDITIONS

POWER SOURCE 208-230v 60Hz

JIS STANDARD

○—○

Heating

3D101087B

4MXL36WVJU9, 4MXLH36WVJU9

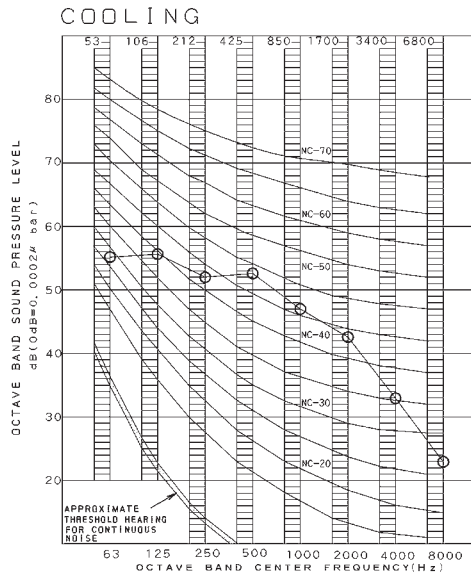

OVER ALL (dB)		OPERATING CONDITIONS	
SCALE	208V-230V 60Hz	POWER SOURCE	208-230v 60 Hz
A	53	JIS STANDARD (JISC9612)	
		Cooling	

(B G N IS ALREADY RECTIFIED)

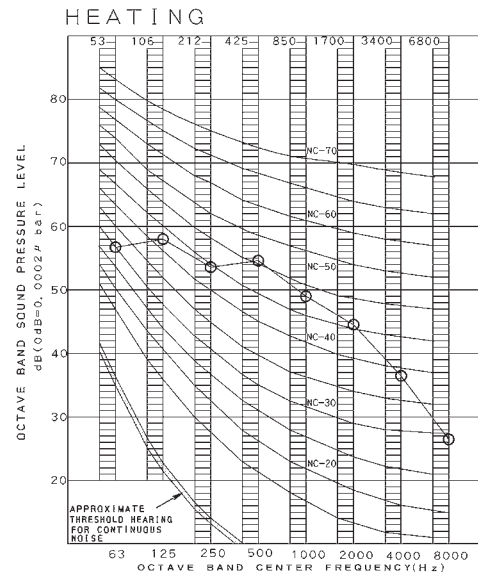

OVER ALL (dB)		OPERATING CONDITIONS	
SCALE	208V-230V 60Hz	POWER SOURCE	208-230v 60 Hz
A	55	JIS STANDARD (JISC9612)	
		Heating	

(B G N IS ALREADY RECTIFIED)

3D118335

11 Electric Characteristics

Model		Power Supply				Compressor	OFM		
		Hz - Volts	Voltage Range	MCA	MFA	RLA	Hp	W	FLA
MXS Series	2MXS18WMVJU9	60 Hz - 208 V 60 Hz - 230 V	Max. 60 Hz, 253 V Min. 60 Hz, 187 V	15.5	20.0	14.0	0.07	55	0.38
	3MXS24WMVJU9	60 Hz - 208 V 60 Hz - 230 V	Max. 60 Hz, 253 V Min. 60 Hz, 187 V	18.1	25.0	15.5	0.07	50	0.34
	4MXS36WMVJU9	60 Hz - 208 V 60 Hz - 230 V	Max. 60 Hz, 253 V Min. 60 Hz, 187 V	20.9	25.0	17.5	0.12	89	0.49
	5MXS48WVJU9	60 Hz - 208 V 60 Hz - 230 V	Max. 60 Hz, 253 V Min. 60 Hz, 187 V	30.8	35.0	27.0	0.17	126	0.76
MXL Series	2MXL18WMVJU9	60 Hz - 208 V 60 Hz - 230 V	Max. 60 Hz, 253 V Min. 60 Hz, 187 V	17.0	20.0	15.5	0.11	78	0.43
	3MXL24WMVJU9	60 Hz - 208 V 60 Hz - 230 V	Max. 60 Hz, 253 V Min. 60 Hz, 187 V	20.1	25.0	17.5	0.12	89	0.49
	4MXL36WVJU9	60 Hz - 208 V 60 Hz - 230 V	Max. 60 Hz, 253 V Min. 60 Hz, 187 V	30.2	35.0	27.0	0.17	126	0.76
MXLH Series	2MXLH18WVJU9	60 Hz - 208 V 60 Hz - 230 V	Max. 60 Hz, 253 V Min. 60 Hz, 187 V	17.0	20.0	15.5	0.11	78	0.43
	3MXLH24WVJU9	60 Hz - 208 V 60 Hz - 230 V	Max. 60 Hz, 253 V Min. 60 Hz, 187 V	20.1	25.0	17.5	0.12	89	0.49
	4MXLH36WVJU9	60 Hz - 208 V 60 Hz - 230 V	Max. 60 Hz, 253 V Min. 60 Hz, 187 V	30.2	35.0	27.0	0.17	126	0.76

C: 3D141390

C: 3D141413

Symbols:

MCA	: Min. circuit amps	(A)
MFA	: Max. fuse amps	(A)
RLA	: Rated load amps	(A)
OFM	: Outdoor fan motor	
IFM	: Indoor fan motor	
FLA	: Full load amps	(A)
W	: Fan motor rated output	(W)

Notes:

1. RLA is the max current that comes in cooling operation and heating operation.
2. Maximum allowable voltage variation between phases is 2%.
3. Select wire size based on the larger value of MCA.
4. Instead of fuse, use circuit breaker.
5. Be sure to install a ground leak detector.
(This unit uses an inverter, which means that an earth leak detector capable of handling high harmonics must be used in order to prevent malfunctioning of the ground leak detector.)

Part 2 Installation Manual

1. Indoor Unit	74
1.1 CTXS, FTXS09/12	74
1.2 FTXS15/18/24.....	87
1.3 FTXR	100
1.4 FVXS	114
1.5 CDMQ, FDMQ	132
1.6 FFQ.....	156
2. Outdoor Unit	182
2.1 2/3/4MXS, 2/3MXL, 2/3MXLH.....	182
2.2 5MXS, 4MXL, 4MXLH.....	200
3. Remote Controller (Required Option for CDMQ, FDMQ, FFQ).....	218
3.1 BRC1E73.....	218
3.2 BRC082A43 for CDMQ, FDMQ	239
3.3 BRC082A41W, BRC982A42W(S) for FFQ.....	244

1. Indoor Unit

1.1 CTXS, FTXS09/12

Contents

Safety Considerations.....	1	Refrigerant Piping Work.....	10
Accessories	3	1. Flaring the pipe end.....	10
Choosing an Installation Site	3	2. Refrigerant piping	10
1. Indoor unit	3	Installation Tips.....	11
2. Wireless remote controller.....	3	1. Removing and installing front panel	11
Indoor Unit Installation	4	2. Removing and installing the front grille.....	11
1. Installing the mounting plate.....	5	3. How to set the different addresses	12
2. Drilling a wall hole and installing wall embedded pipe...5		4. When connecting to an HA system	12
3. Installing the indoor unit	6	Trial Operation and Testing.....	13
4. Wiring	8	1. Trial operation and testing	13
5. Drain piping	9	2. Test items	13

The pictures in this document are for illustrative purposes only.

Safety Considerations

Refer also to the General Safety Considerations in the separate booklet.







Read the precautions in this manual carefully before operating the unit.

Read these **Safety Considerations for Installation** carefully before installing an air conditioner or heat pump. After completing the installation, make sure that the unit operates properly during the startup operation. Instruct the user on how to operate and maintain the unit. Inform users that they should store this installation manual with the operation manual for future reference. Always use a licensed installer or contractor to install this product.

Improper installation can result in water or refrigerant leakage, electric shock, fire, or explosion.

Meanings of **DANGER**, **WARNING**, **CAUTION**, and **NOTE** Symbols:

-  **DANGER** Indicates an imminently hazardous situation which, if not avoided, will result in death or serious injury.
-  **WARNING** Indicates a potentially hazardous situation which, if not avoided, could result in death or serious injury.
-  **CAUTION** Indicates a potentially hazardous situation which, if not avoided, may result in minor or moderate injury. It may also be used to alert against unsafe practices.
-  **NOTE** Indicates situations that may result in equipment or property damage accidents only.

DANGER

- Refrigerant gas is heavier than air and replaces oxygen. A massive leak can lead to oxygen depletion, especially in basements, and an asphyxiation hazard could occur leading to serious injury or death.
- Do not ground units to water pipes, gas pipes, telephone wires, or lightning rods as incomplete grounding can cause a severe shock hazard resulting in severe injury or death. Additionally, grounding to gas pipes could cause a gas leak and potential explosion causing severe injury or death.

- If refrigerant gas leaks during installation, ventilate the area immediately. Refrigerant gas may produce toxic gas if it comes into contact with fire. Exposure to this gas could cause severe injury or death.
- After completing the installation work, check that the refrigerant gas does not leak throughout the system.
- Do not install unit in an area where flammable materials are present due to risk of explosions that can cause serious injury or death.
- Safely dispose all packing and transportation materials in accordance with federal/state/local laws or ordinances. Packing materials such as nails and other metal or wood parts, including plastic packing materials used for transportation may cause injuries or death by suffocation.

WARNING

- Only qualified personnel licensed or certified in their jurisdiction must carry out the installation work. Installation must be done in accordance with this installation manual. Improper installation may result in water leakage, electric shock, or fire.
- When installing the unit in a small room, take measures to keep the refrigerant concentration from exceeding allowable safety limits. Excessive refrigerant leaks, in the event of an accident in a closed ambient space, can lead to oxygen deficiency.
- Use only specified accessories and parts for installation work. Failure to use specified parts may result in water leakage, electric shock, fire, or the unit falling.
- Install the air conditioner or heat pump on a foundation strong enough that it can withstand the weight of the unit. A foundation of insufficient strength may result in the unit falling and causing injuries.
- Take into account strong winds, typhoons, or earthquakes when installing. Improper installation may result in the unit falling and causing accidents.
- Make sure that a separate power supply circuit is provided for this unit and that all electrical work is carried out by qualified personnel licensed or certified in their jurisdiction according to local, state, and national regulations. An insufficient power supply capacity or improper electrical construction may lead to electric shock or fire.
- Make sure that all wiring is secured, that specified wires are used, and that no external forces act on the terminal connections or wires. Improper connections or installation may result in fire.

- When wiring, position the wires so that the electrical wiring box cover can be securely fastened. Improper positioning of the electrical wiring box cover may result in electric shock, fire, or the terminals overheating.
 - Before touching electrical parts, turn off the unit.
 - The circuit must be protected with safety devices in accordance with local and national codes, i.e. a circuit breaker.
 - Securely fasten the outdoor unit terminal cover (panel). If the terminal cover/panel is not installed properly, dust or water may enter the outdoor unit causing fire or electric shock.
 - When installing or relocating the system, keep the refrigerant circuit free from substances other than the specified refrigerant (R410A) such as air. Any presence of air or other foreign substance in the refrigerant circuit can cause an abnormal pressure rise or rupture, resulting in equipment damage and even injury.
 - Do not change the setting of the protection devices. If the pressure switch, thermal switch, or other protection device is shorted and operated forcibly, or parts other than those specified by Daikin are used, fire or explosion may occur.
 - Do not use means to accelerate the defrosting process (if possible) or to clean, other than those recommended by the manufacturer.
 - The appliance must be stored in a room without continuously operating ignition sources (for example: open flames, an operating gas appliance or an operating electric heater).
 - Do not pierce or burn.
 - Be aware that refrigerants may not contain an odor.
 - Comply with national gas regulations.
- (b) Tight -- R410A does not contain any chlorine, does not destroy the ozone layer, and does not reduce the earth's protection against harmful ultraviolet radiation. R410A can contribute to the greenhouse effect if it is released. Therefore take proper measures to check for the tightness of the refrigerant piping installation. Read the chapter *Refrigerant Piping Work* and follow the procedures.
- Since R410A is a blend, the required additional refrigerant must be charged in its liquid state. If the refrigerant is charged in a state of gas, its composition can change and the system will not work properly.
 - The indoor unit is for R410A. See the catalog for outdoor models that can be connected. Normal operation is not possible when connected to non-compatible outdoor units.
 - Remote controller (wireless kit) transmitting distance can be shorter than expected in rooms with electronic fluorescent lamps (inverter or rapid start types). Install the indoor unit far away from fluorescent lamps as much as possible.
 - Indoor units are for indoor installation only. Outdoor units can be installed either outdoors or indoors.
 - Do not install the air conditioner or heat pump in the following locations:
 - (a) Where a mineral oil mist or oil spray or vapor is produced, for example, in a kitchen. Plastic parts may deteriorate and fall off or result in water leakage.
 - (b) Where corrosive gas, such as sulfurous acid gas, is produced. Corroding copper pipes or soldered parts may result in refrigerant leakage.
 - (c) Near machinery emitting electromagnetic waves. Electromagnetic waves may disturb the operation of the control system and cause the unit to malfunction.
 - (d) Where flammable gas may leak, where there is carbon fiber, or ignitable dust suspension in the air, or where volatile flammables such as thinner or gasoline are handled. Operating the unit in such conditions can cause a fire.
 - Take adequate measures to prevent the outdoor unit from being used as a shelter by small animals. Small animals making contact with electrical parts can cause malfunctions, smoke, or fire. Instruct the user to keep the area around the unit clean.
 - Servicing shall be performed only as recommended by the manufacturer and licensed or certified in their jurisdiction.

CAUTION

- Do not touch the switch with wet fingers. Touching a switch with wet fingers can cause electric shock.
- Do not allow children to play on or around the unit to prevent injury.
- Wear adequate personal protective equipment (protective gloves, safety glasses,...) when installing, maintaining or servicing the system.
- The heat exchanger fins are sharp enough to cut. To avoid injury, wear gloves or cover the fins while working around them.
- Do not touch the refrigerant pipes during and immediately after operation as the refrigerant pipes may be hot or cold, depending on the condition of the refrigerant flowing through the refrigerant piping, compressor, and other refrigerant cycle parts. Your hands may suffer burns or frostbite if you touch the refrigerant pipes. To avoid injury, give the pipes time to return to normal temperature or, if you must touch them, be sure to wear proper gloves.
- Install drain piping to ensure proper drainage. Improper drain piping may result in water leakage and property damage.
- Insulate piping to prevent condensation.
- Be careful when transporting the product.
- Do not turn off the power immediately after stopping operation. Always wait for at least 5 minutes before turning off the power. Otherwise, water leakage may occur.
- Do not use a charging cylinder. Using a charging cylinder may cause the refrigerant to deteriorate.
- Refrigerant R410A in the system must be kept clean, dry, and tight.
 - (a) Clean and Dry -- Foreign materials (including mineral oils such as SUNISO oil or moisture) should be prevented from getting into the system.











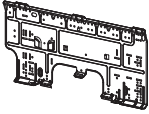

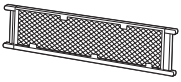
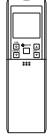
NOTE

- The indoor unit should be positioned where the unit and inter-unit wires (outdoor to indoor) are at least 3.3ft (1m) away from any televisions or radios. (The unit may cause interference with the picture or sound.) Depending on the radio waves, a distance of 3.3ft (1m) may not be sufficient to eliminate the noise.
- Dismantling the unit, treatment of the refrigerant, oil and additional parts must be done in accordance with the relevant local, state, and national regulations.
- Only use tools for R410A, such as a gauge manifold, charge hose, gas leak detector, reverse flow check valve, refrigerant charge base, vacuum gauge, or refrigerant recovery equipment.
- If the conventional refrigerant and refrigerator oil are mixed in R410A, the refrigerant may deteriorate.
- This air conditioner or heat pump is an appliance that should not be accessible to the general public.
- As maximum allowable pressure is 604psi (4.17MPa), the wall thickness of field-installed pipes should be selected in accordance with the relevant local, state, and national regulations.

FTN005-U

2

Accessories

<p>(A) Mounting plate</p>  <p>1</p>	<p>(B) Mounting plate fixing screw M4 × 1" (M4 × 25mm)</p>  <p>5</p>	<p>(C) Titanium apatite deodorizing filter</p>  <p>2</p>
<p>(D) Wireless remote controller</p>  <p>1</p>	<p>(E) Remote controller holder</p>  <p>1</p>	<p>(F) Remote controller holder fixing screw M3 × 13/16" (M3 × 20mm)</p>  <p>2</p>
<p>(G) Dry battery AAA. LR03 (alkaline)</p>  <p>2</p>	<p>(H) Indoor unit fixing screw M4 × 1/2" (M4 × 12mm)</p>  <p>2</p>	<p>(J) Tube</p>  <p>1</p>
<p>(K) Operation manual</p>  <p>1</p>	<p>(L) Installation manual</p>  <p>1</p>	<p>(M) General safety considerations</p>  <p>1</p>
<p>(N) Warranty</p>  <p>1</p>		

Choosing an Installation Site

• Before choosing the installation site, obtain user approval.

1. Indoor unit

- The indoor unit should be positioned in a place where:
 - 1) the restrictions on the installation requirements specified in “**Indoor Unit Installation**” on page 4 are met,
 - 2) both the air inlet and air outlet are unobstructed,
 - 3) the unit is not exposed to direct sunlight,
 - 4) Install so that drainage occurs easily,
 - 5) the unit is away from sources of heat or steam,
 - 6) there is no source of machine oil vapor (this may shorten the indoor unit service life),
 - 7) cool/warm air is circulated throughout the room,
 - 8) the unit is away from electronic ignition type fluorescent lamps (inverter or rapid start type) as they may affect the remote controller range,
 - 9) no laundry equipment is nearby.

2. Wireless remote controller

- Turn on all the fluorescent lamps in the room, if any, and find a location where the remote controller signals are properly received by the indoor unit (within 23ft (7m)).

Indoor Unit Installation

⚠ CAUTION

- Do not hit or forcefully push the INTELLIGENT EYE sensor. This can lead to damage and malfunction.
- Do not place large objects near the sensor. Also keep heating units or humidifiers outside the sensor's detection area.

How to attach the indoor unit
Hook the claws of the bottom frame to the mounting plate.
If the claws are difficult to hook, remove the front grille.

How to remove the indoor unit
Push up the marked area (at the lower part of the front grille) to release the claws. If it is difficult to release, remove the front grille.

How to install the mounting plate
The mounting plate should be installed on a wall which can support the weight of the indoor unit.

How to install the front panel
The front panel should be installed on a wall which can support the weight of the indoor unit.

How to install the drain pipe
Do not connect commercially available drain hose directly to the indoor unit. (Water leakage may result)

Cut thermal insulation pipe to an appropriate length and wrap it with tape, making sure that no gap is left in the insulation pipe's cut line.

Wrap the thermal insulation pipe with the finishing tape from bottom to top.

How to install the air filters
Titanium apatite deodorizing filter (2 pcs)

How to open the service lid
Service lid is opening/closing type.

Opening method

- 1) Remove the service lid screw.
- 2) Pull out the service lid diagonally down in the direction of the arrow.
- 3) Pull down.

How to install the remote controller holder
Before screwing the remote controller holder to the wall, make sure that control signals are properly received by indoor unit.

How to install the remote controller
Wireless remote controller

Indoor Unit Installation

1. Installing the mounting plate

- The mounting plate should be installed on a wall which can support the weight of the indoor unit.
 - Temporarily secure the mounting plate to the wall, make sure that the plate is completely level, and mark the drilling points on the wall.
 - Secure the mounting plate to the wall with screws.

Recommended mounting plate retention spots and dimensions

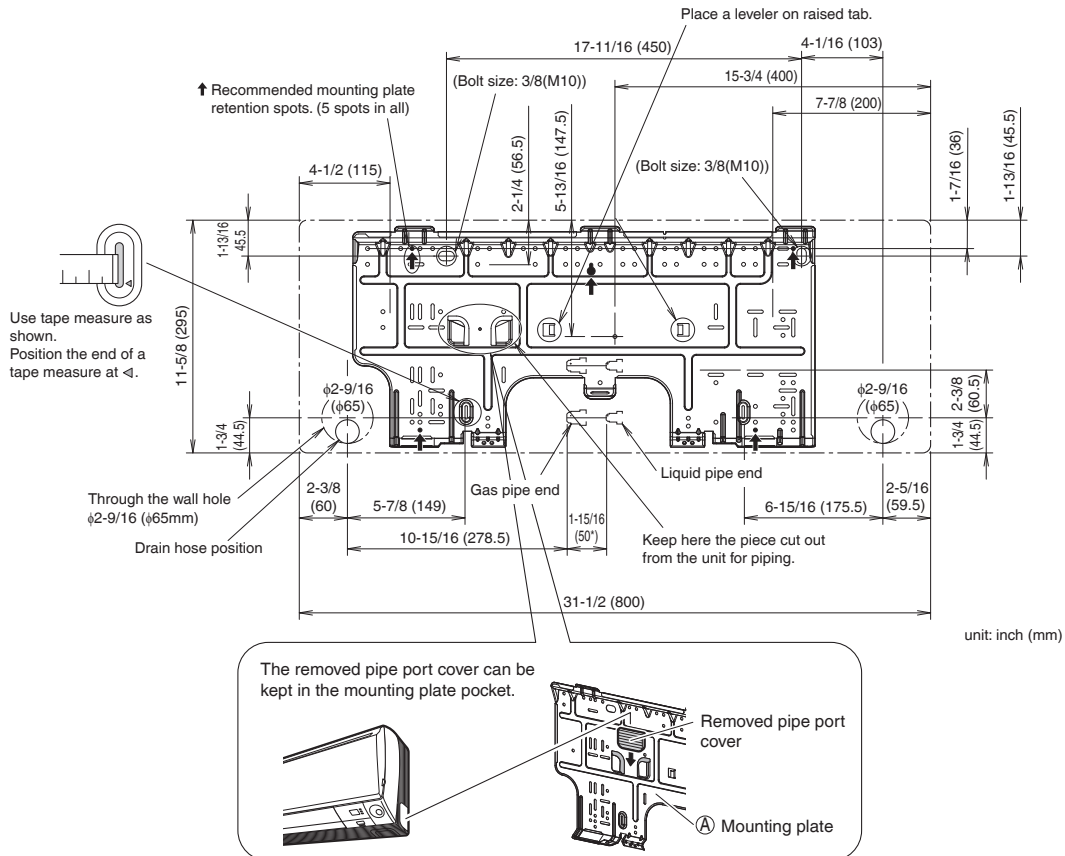

* Depending on the model, the actual distance between the liquid pipe end and gas pipe end may differ from the distance between those symbols on the mounting plate (the distance listed in this manual).

Always measure the actual distance between the liquid pipe end and gas pipe end before installing refrigerant pipes.

2. Drilling a wall hole and installing wall embedded pipe

⚠ WARNING

For metal frame or metal board walls, be sure to use a wall embedded pipe and wall hole cover in the feed-through hole to prevent possible heat, electric shock, or fire.

- Be sure to caulk the gaps around the pipes with caulking material. (to prevent condensation caused by intrusion of air from outside or within the wall)
 - Drill a feed-through hole with a φ2-9/16 inch (65mm) diameter through the wall at a downward angle toward the outside. (to prevent water leakage)
 - Insert a wall embedded pipe into the hole.
 - Insert a wall hole cover into wall pipe.
 - After completing refrigerant piping, wiring, and drain piping, caulk the pipe hole gap with putty.

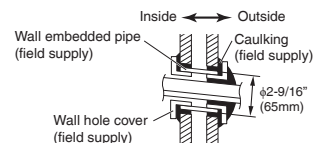

Even if a wall hole cover is not used, caulk both the outdoor and indoor sides with putty.

3. Installing the indoor unit

In the case of bending or curing refrigerant pipes, keep the following precautions in mind.

Abnormal sound may be generated if improper work is conducted.

- Do not strongly press the refrigerant pipes onto the bottom frame.
- Do not strongly press the refrigerant pipes on the front grille, either.

3-1. Right-side, right-back, or right-bottom piping

- 1) Attach the drain hose to the underside of the refrigerant pipes with adhesive vinyl tape.
- 2) Wrap the refrigerant pipes and drain hose together with insulation tape.

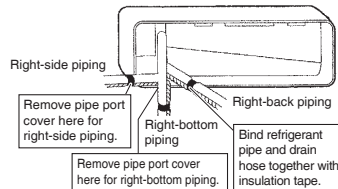

- 3) Pass the drain hose and refrigerant pipes through the wall hole, then position the indoor unit on the (A) mounting plate hooks by using the △ markings at the top of the indoor unit as a guide.

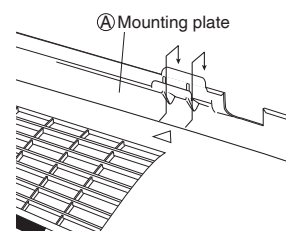

- 4) Open the front panel, then open the service lid (Refer to “Indoor Unit Installation” on page 4).
- 5) Pass the inter-unit wire from the outdoor unit through the feed-through wall hole and pass to the front of indoor unit from the back. Then pull them at front side. Bend the ends of cable tie wires upward for easier work in advance. (If the inter-unit wire ends are to be stripped first, bundle wire ends with adhesive tape.)
- 6) Press the bottom frame of the indoor unit with both hands until it is firmly caught by the (A) mounting plate hooks. Make sure the wire leads do not catch on the edge of the indoor unit.

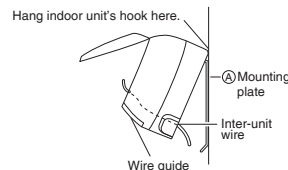

3-2. Left-side, left-back, or left-bottom piping

- 1) Switch around the drain plug and drain hose.

How to switch around the drain plug and drain hose

1) Remove the fixing screw and pull out the drain hose.

2) Pull out drain plug.

3) Switch around the drain hose and drain plug.

Push the drain plug all the way in using a hexagonal wrench (3/16 inch (4mm)).

Do not apply lubricating oil (refrigerant oil) to the drain plug when inserting it. The application of lubrication oil to the drain plug will deteriorate the plug to cause drain leakage from the plug.

Insert a hexagonal wrench (3/16 inch (4mm)).

Insert drain hose securely and fix in place with fixing screw.

Indoor Unit Installation

- 2) Attach the drain hose to the underside of the refrigerant pipes with adhesive vinyl tape.

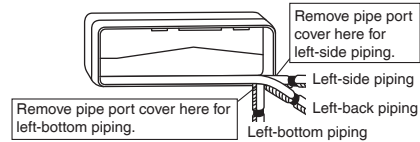

- 3) Shape the refrigerant pipes along the pipe path marking on the (A) mounting plate.

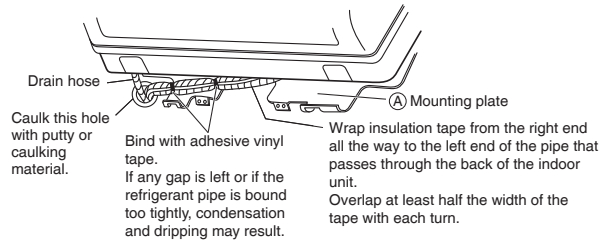

- 4) Pass the drain hose and refrigerant pipes through the wall hole, then position the indoor unit on the (A) mounting plate hooks, using the Δ markings at the top of the indoor unit as a guide.

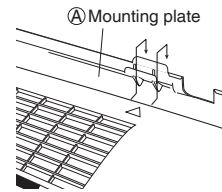

- 5) Open the front panel (Refer to "Installation Tips" on page 11), then open the service lid (Refer to "Indoor Unit Installation" on page 4).

- 6) Pass the inter-unit wire from the outdoor unit through the feed-through wall hole and pass to the front of indoor unit from the back. Then pull them at front side. Bend the ends of cable tie wires upward for easier work in advance. (If the inter-unit wire ends are to be stripped first, bundle wire ends with adhesive tape.)

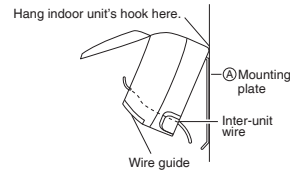

- 7) Connect the refrigerant pipes.
- 8) In case of pulling the drain hose through the back of the indoor unit, wrap the refrigerant pipes and drain hose together with insulation tape as shown in the right figure.
- 9) Press the bottom frame of the indoor unit with both hands until it is firmly caught by the (A) mounting plate hooks. Make sure that the wires do not catch on the edge of the indoor unit.

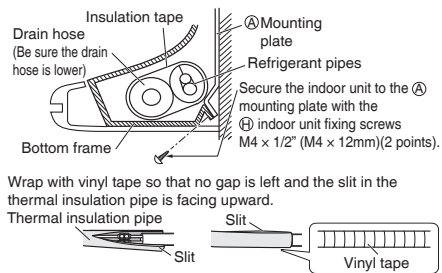

3-3. Wall embedded piping

Follow the instructions given under left-side, left-back, or left-bottom piping.

- 1) Insert the drain hose to a depth of 1-15/16 inches (50mm) or more so it will not be pulled out of the drain pipe.

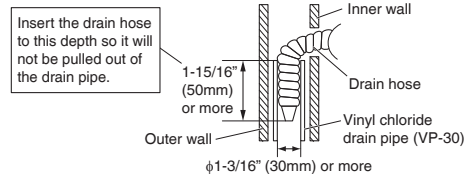

4. Wiring

Refer to the installation manual for the outdoor unit also.

⚠ WARNING

- Do not use tapped wires, extension cords, or starburst connections, as they may cause overheating, electric shock, or fire.
- Do not use locally purchased electrical parts inside the product. (Do not branch the power for the drain pump, etc., from the terminal block.) Doing so may cause electric shock or fire.
- Do not connect the power wire to the indoor unit. Doing so may cause electric shock or fire.

⚠ CAUTION

Recommend stranded cable for interunit wiring. Local code always supersedes recommendation.

- For stranded wires, make sure to use the round crimp-style terminal for connection to the power supply terminal block. Place the round crimp-style terminals on the wires up to the covered part and secure in place.

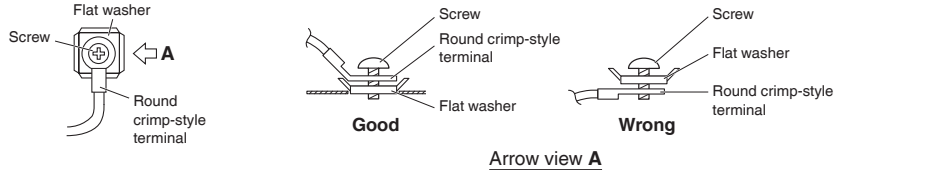

- If solid core wire must be used, be sure to curl the end of the lead. Improper work may cause heat and fire.

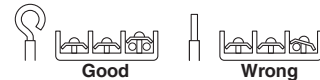

With a multi indoor unit, install as described in the installation manual supplied with the Multi outdoor unit.

- 1) As shown in the illustration on the right-hand side, insert the wires including the ground wire into the conduit and secure them with lock nut onto the conduit mounting plate.
- 2) Insert the wires including the ground wire into Ⓧ tube.
 - Cut Ⓧ tube when Ⓧ tube is too long.
- 3) Strip wire ends (3/4 inch (20mm)).
- 4) Match wire colors with terminal numbers on indoor and outdoor unit's terminal blocks and firmly screw wires to the corresponding terminals.
- 5) Connect the ground wires to the corresponding terminals.
- 6) Pull the wires and check that the wires are securely fixed to the terminal block.
- 7) In case of connecting to an adapter system, run the remote controller cable and attach the S21. (Refer to P12 when connecting to an HA system.)
- 8) Shape the wires so that the service lid fits securely, then close service lid.

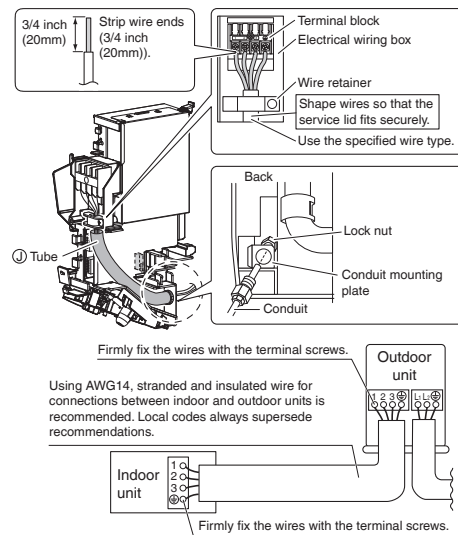

Indoor Unit Installation

5. Drain piping

- 1) Connect the drain hose, as described on the right.
 - Avoid placing the end of the drain hose in a drainage location that could cause bad odors or corrosive gas to flow backward into the outlet.
 - The drainage water may change color due to bacteria or other organisms. Place in a location where the flow of drainage water will not cause a problem.
 - Minimize the number of bends in the drain hose as much as possible. If bending the drain hose, bend it gently.
- 2) Remove the air filters and transfer some water to the indoor heat exchanger by pouring water into the drain pan.
- 3) Make sure that water flows out of the drain hose.
- 4) If drain hose extension or embedded drain piping is required, use appropriate parts that match the hose front end.

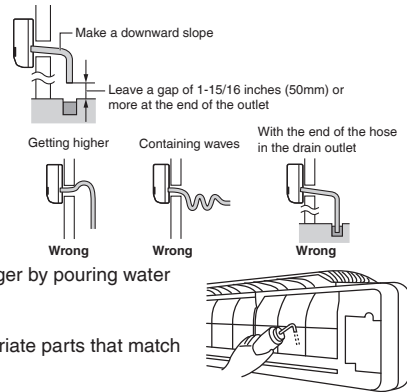
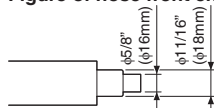
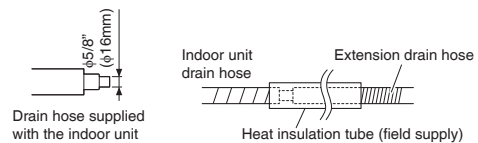

Figure of hose front end



- When drain hose requires extension, obtain an extension hose with an inner diameter of 5/8 inch (16mm). Be sure to thermally insulate the indoor section of the extension hose.



- When connecting a rigid polyvinyl chloride pipe (nominal diameter 1/2 inch (13mm)) directly to the drain hose attached to the indoor unit as with embedded piping work, use any commercially available drain socket (nominal diameter 1/2 inch (13mm)) as a joint.

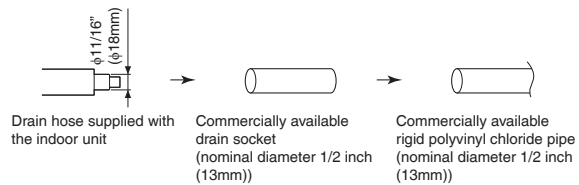

Refrigerant Piping Work

⚠ WARNING

- Do not apply mineral oil to the flare.
- Prevent mineral oil from getting into the system as this would reduce the service life of the units.
- Never use piping which has been used for previous installations. Only use parts which are delivered with this unit.
- Never install a dryer to this R410A unit in order to guarantee its service life.
- The drying material may dissolve and damage the system.
- Improper flaring may result in refrigerant gas leakage.

1. Flaring the pipe end

- 1) Cut the pipe end with a pipe cutter.
- 2) Remove burrs with the cut surface facing downward, so that the filings do not enter the pipe.



- 3) Put the flare nut on the pipe.
- 4) Flare the pipe.
- 5) Check that the flaring has been done correctly.

Set exactly at the position shown below.

Flare tool for R410A		Conventional flare tool	
	Clutch-type	Clutch-type (Rigid-type)	Wing-nut type (Imperial-type)
A	0-0.020 inch (0-0.5mm)	0.039-0.059 inch (1.0-1.5mm)	0.059-0.079 inch (1.5-2.0mm)

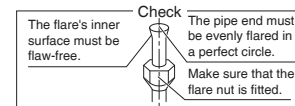

2. Refrigerant piping

⚠ CAUTION

- Use the flare nut fixed to the main unit. (This is to prevent the flare nut from cracking as a result of deterioration over time.)
 - To prevent gas leakage, apply refrigeration oil only to the inner surface of the flare. (Use refrigeration oil for R410A.)
 - Use a torque wrench when tightening the flare nuts to prevent damage to the flare nuts and gas leakage.
- 1) Align the centers of both flares and tighten the flare nuts 3 or 4 turns by hand, then tighten them fully with a spanner and a torque wrench.

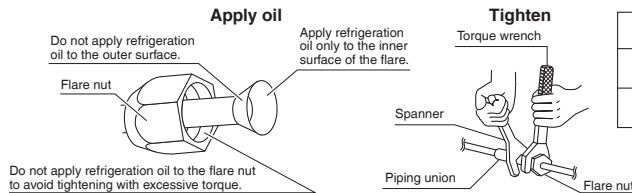

	Piping size	Flare nut tightening torque
Gas side	O.D. 3/8 inch (9.5mm)	24-1/8 – 29-1/2 lbf • ft (32.7-39.9 N • m)
Liquid side	O.D. 1/4 inch (6.4mm)	10-1/2 – 12-3/4 lbf • ft (14.2-17.2 N • m)

Caution on piping handling

- Protect the open end of the pipe against dust and moisture.
- All pipe bends should be as gentle as possible. Use a pipe bender for bending.

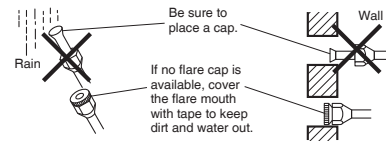

Selection of copper and heat insulation materials

When using commercial copper pipes and fittings, observe the following:

- Insulation material: Polyethylene foam
Heat transfer rate: 0.041 to 0.052W/mK (0.024 to 0.030Btu/ft²°F (0.035 to 0.045kcal/mh°C))
Be sure to use insulation that is designed for use with HVAC Systems.

- ACR Copper only.
- Be sure to insulate both the gas and liquid piping and observe the insulation dimensions as below.

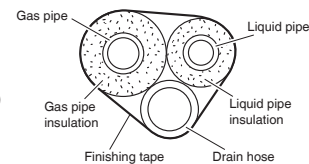

	Piping size	Minimum bend radius	Piping thickness	Thermal insulation size	Thermal insulation thickness
Gas side	O.D. 3/8 inch (9.5mm)	1-3/16 inch (30mm) or more	0.031 inch (0.8mm) (C1220T-O)	I.D. 15/32-19/32 inch (12-15mm)	13/32 inch (10mm) Min.
Liquid side	O.D. 1/4 inch (6.4mm)	1-3/16 inch (30mm) or more	0.031 inch (0.8mm) (C1220T-O)	I.D. 5/16-13/32 inch (8-10mm)	

- Use separate thermal insulation pipes for gas and liquid refrigerant pipes.
- Using finishing tape, bundle and wrap the indoor unit piping and drain hose together so that the drain hose is below the other piping.

Installation Tips

1. Removing and installing front panel

• Removal method

- 1) Place your fingers in the indentations on the main unit (one each on the left and right sides), and open the front panel until it stops.
- 2) While pushing the left side front panel shaft outward, push up the front panel and remove it. (Remove the right side front panel shaft in the same manner.)
- 3) After removing both front panel shafts, pull the front panel toward yourself and remove it.

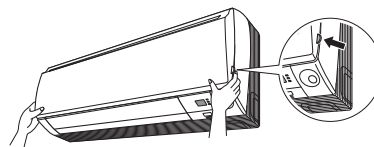

• Installation method

Align the tabs of the front panel with the grooves, and push all the way in. Then close slowly. Push the center of the lower surface of the panel firmly to engage the tabs.

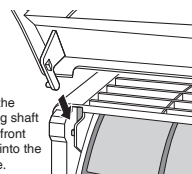
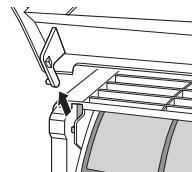

2. Removing and installing the front grille

• Removal method

- 1) Remove the front panel and air filters.
- 2) Remove the front grille fixing screws (2 screws). (See Fig. 1)
- 3) Remove the service lid screw (1 screw) and remove service lid. (See Fig. 2)
- 4) In front of the ○○○ mark on the front grille, there are 3 upper hooks. Lightly pull the front grille toward you with one hand, and push down on the hooks with the fingers of your other hand. (See Fig. 3)

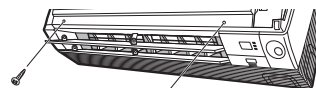

Fig. 1

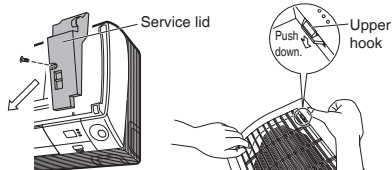

Fig. 2

Fig. 3

When there is insufficient work space because the unit is close to ceiling

Place both hands under the center of the front grille, and while pushing up, pull it toward you.

• Installation method

- 1) Install the front grille and firmly engage the upper hooks (3 locations).
- 2) Install the 2 screws of the front grille.
- 3) Install the service lid and screw for fixing the service lid (1 screw).
- 4) Install the air filters and then mount the front panel.

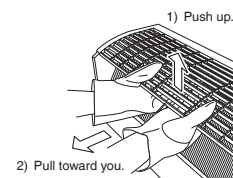

CAUTION

- Be sure to wear protection gloves.

3. How to set the different addresses

When 2 indoor units are installed in one room, the 2 wireless remote controllers can be set for different addresses.

- 1) Remove the metal plate electrical wiring cover.
(Refer to the **When connecting to an HA system.**)
- 2) Cut the address jumper (JA) on the printed circuit board.
- 3) Cut the address jumper (J4) in the remote controller.

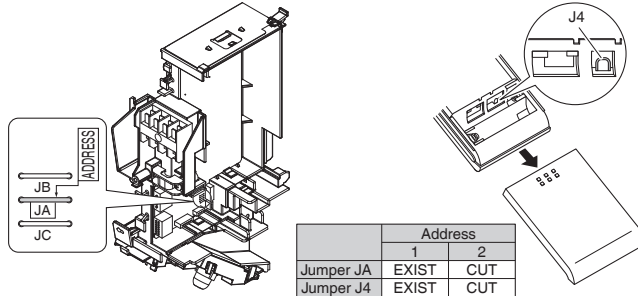

4. When connecting to an HA system

For this procedure, accessories which are sold separately are needed. (wired remote controller, central remote controller, etc.)

- 1) Remove the front grille.
(Refer to **“Removing and installing the front grille”** on page 11.)
- 2) Remove electrical wiring box. (1 screw)
- 3) Remove the metal plate electrical wiring cover. (5 tabs)

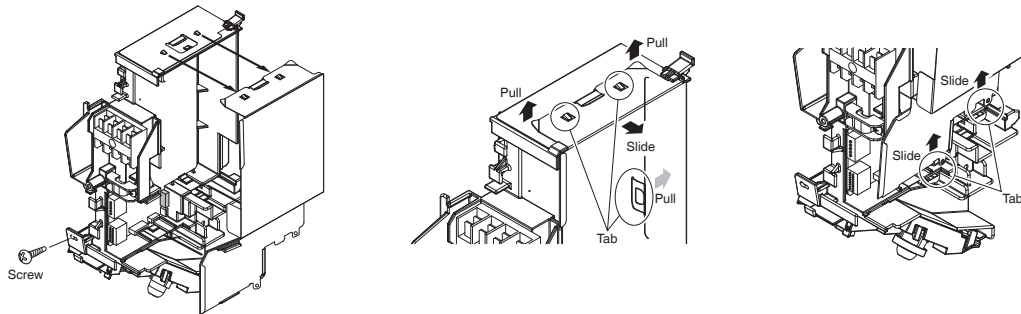

- 4) Attach the connection cord to the S21 connector and pull the harness out through the notched part in the figure.
- 5) Replace the electrical wiring cover as it was, and pull the harness around, as shown in the figure.

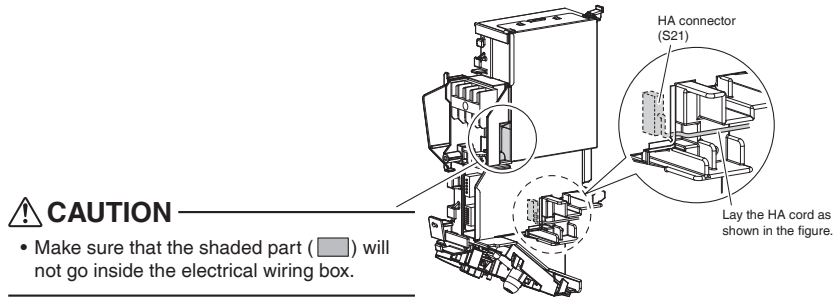

CAUTION

- Make sure that the shaded part (■) will not go inside the electrical wiring box.

Trial Operation and Testing

1. Trial operation and testing

- Trial operation should be carried out in either COOL or HEAT operation.

1-1. Measure the supply voltage and make sure that it is within the specified range.



1-2. In COOL operation, select the lowest programmable temperature; in HEAT operation, select the highest programmable temperature.

1-3. Carry out the trial operation following the instructions in the operation manual to ensure that all functions and parts, such as the movement of the flap, are working properly.

- To protect the air conditioner, restart operation is disabled for 3 minutes after the system has been turned off.

1-4. After trial operation is complete, set the temperature to a normal level (78°F to 82°F (26°C to 28°C) in COOL operation, 68°F to 75°F (20°C to 24°C) in HEAT operation).

- When operating the air conditioner in COOL operation in winter, or HEAT operation in summer, set it to the trial operation mode using the following method.

- 1) Press  button (2 locations) and **MODE** button at the same time.
- 2) Press **MODE** button twice.
(" ? " will appear on the display to indicate that trial operation mode is selected.)
- 3) Press **MODE** and select the COOL or HEAT operation.
- 4) Press  button to turn on the system.
 - Trial operation terminates in approx. 30 minutes and switches into normal mode.
 - To quit a trial operation, press  button.



HEAT PUMP model

- The air conditioner draws a small amount of power in its standby mode. If the system is not to be used for some time after installation, shut off the circuit breaker to eliminate unnecessary power consumption.
- If the circuit breaker trips to shut off the power to the air conditioner, the system will restore the original operation mode when the circuit breaker is turned on again.

2. Test items

Test items	Symptom	Check
Indoor and outdoor units are installed securely.	Fall, vibration, noise	
No refrigerant gas leaks.	Incomplete cooling/heating function	
Refrigerant gas and liquid pipes and indoor drain hose extension are thermally insulated.	Water leakage	
Draining line is properly installed.	Water leakage	
System is properly grounded.	Electrical leakage	
Only specified wires are used for all wiring, and all wires are connected correctly.	No operation or burn damage	
Indoor or outdoor unit's air inlet or air outlet are unobstructed.	Incomplete cooling/heating function	
Stop valves are opened.	Incomplete cooling/heating function	
Indoor unit properly receives remote control commands.	No operation	
The heat pump or cooling only mode is selectable with the DIP switch of the remote controller.	Remote controller malfunctioning	

1.2 FTXS15/18/24

Contents

Safety Considerations.....	1	Refrigerant Piping Work.....	10
Accessories	3	1. Flaring the pipe end.....	10
Choosing an Installation Site	3	2. Refrigerant piping	10
1. Indoor unit	3	Installation Tips.....	11
2. Wireless remote controller.....	3	1. Removing and installing front panel	11
Indoor Unit Installation	4	2. Removing and installing the front grille.....	11
1. Installing the mounting plate.....	5	3. How to set the different addresses	12
2. Drilling a wall hole and installing wall embedded pipe...5		4. When connecting to an HA system	12
3. Installing the indoor unit	6	Trial Operation and Testing.....	13
4. Wiring	8	1. Trial operation and testing	13
5. Drain piping	9	2. Test items	13

The pictures in this document are for illustrative purposes only.

Safety Considerations

Refer also to the General Safety Considerations in the separate booklet.







Read the precautions in this manual carefully before operating the unit.

Read these **Safety Considerations for Installation** carefully before installing an air conditioner or heat pump. After completing the installation, make sure that the unit operates properly during the startup operation. Instruct the user on how to operate and maintain the unit. Inform users that they should store this installation manual with the operation manual for future reference. Always use a licensed installer or contractor to install this product.

Improper installation can result in water or refrigerant leakage, electric shock, fire, or explosion.

Meanings of **DANGER**, **WARNING**, **CAUTION**, and **NOTE** Symbols:

-  **DANGER** Indicates an imminently hazardous situation which, if not avoided, will result in death or serious injury.
-  **WARNING** Indicates a potentially hazardous situation which, if not avoided, could result in death or serious injury.
-  **CAUTION** Indicates a potentially hazardous situation which, if not avoided, may result in minor or moderate injury. It may also be used to alert against unsafe practices.
-  **NOTE** Indicates situations that may result in equipment or property damage accidents only.

DANGER

- Refrigerant gas is heavier than air and replaces oxygen. A massive leak can lead to oxygen depletion, especially in basements, and an asphyxiation hazard could occur leading to serious injury or death.
- Do not ground units to water pipes, gas pipes, telephone wires, or lightning rods as incomplete grounding can cause a severe shock hazard resulting in severe injury or death. Additionally, grounding to gas pipes could cause a gas leak and potential explosion causing severe injury or death.

- If refrigerant gas leaks during installation, ventilate the area immediately. Refrigerant gas may produce toxic gas if it comes into contact with fire. Exposure to this gas could cause severe injury or death.
- After completing the installation work, check that the refrigerant gas does not leak throughout the system.
- Do not install unit in an area where flammable materials are present due to risk of explosions that can cause serious injury or death.
- Safely dispose all packing and transportation materials in accordance with federal/state/local laws or ordinances. Packing materials such as nails and other metal or wood parts, including plastic packing materials used for transportation may cause injuries or death by suffocation.

WARNING

- Only qualified personnel licensed or certified in their jurisdiction must carry out the installation work. Installation must be done in accordance with this installation manual. Improper installation may result in water leakage, electric shock, or fire.
- When installing the unit in a small room, take measures to keep the refrigerant concentration from exceeding allowable safety limits. Excessive refrigerant leaks, in the event of an accident in a closed ambient space, can lead to oxygen deficiency.
- Use only specified accessories and parts for installation work. Failure to use specified parts may result in water leakage, electric shock, fire, or the unit falling.
- Install the air conditioner or heat pump on a foundation strong enough that it can withstand the weight of the unit. A foundation of insufficient strength may result in the unit falling and causing injuries.
- Take into account strong winds, typhoons, or earthquakes when installing. Improper installation may result in the unit falling and causing accidents.
- Make sure that a separate power supply circuit is provided for this unit and that all electrical work is carried out by qualified personnel licensed or certified in their jurisdiction according to local, state, and national regulations. An insufficient power supply capacity or improper electrical construction may lead to electric shock or fire.
- Make sure that all wiring is secured, that specified wires are used, and that no external forces act on the terminal connections or wires. Improper connections or installation may result in fire.

- When wiring, position the wires so that the electrical wiring box cover can be securely fastened. Improper positioning of the electrical wiring box cover may result in electric shock, fire, or the terminals overheating.
- Before touching electrical parts, turn off the unit.
- The circuit must be protected with safety devices in accordance with local and national codes, i.e. a circuit breaker.
- Securely fasten the outdoor unit terminal cover (panel). If the terminal cover/panel is not installed properly, dust or water may enter the outdoor unit causing fire or electric shock.
- When installing or relocating the system, keep the refrigerant circuit free from substances other than the specified refrigerant (R410A) such as air. Any presence of air or other foreign substance in the refrigerant circuit can cause an abnormal pressure rise or rupture, resulting in equipment damage and even injury.
- Do not change the setting of the protection devices. If the pressure switch, thermal switch, or other protection device is shorted and operated forcibly, or parts other than those specified by Daikin are used, fire or explosion may occur.
- Do not use means to accelerate the defrosting process (if possible) or to clean, other than those recommended by the manufacturer.
- The appliance must be stored in a room without continuously operating ignition sources (for example: open flames, an operating gas appliance or an operating electric heater).
- Do not pierce or burn.
- Be aware that refrigerants may not contain an odor.
- Comply with national gas regulations.

CAUTION

- Do not touch the switch with wet fingers. Touching a switch with wet fingers can cause electric shock.
 - Do not allow children to play on or around the unit to prevent injury.
 - Wear adequate personal protective equipment (protective gloves, safety glasses,...) when installing, maintaining or servicing the system.
 - The heat exchanger fins are sharp enough to cut. To avoid injury, wear gloves or cover the fins while working around them.
 - Do not touch the refrigerant pipes during and immediately after operation as the refrigerant pipes may be hot or cold, depending on the condition of the refrigerant flowing through the refrigerant piping, compressor, and other refrigerant cycle parts. Your hands may suffer burns or frostbite if you touch the refrigerant pipes. To avoid injury, give the pipes time to return to normal temperature or, if you must touch them, be sure to wear proper gloves.
 - Install drain piping to ensure proper drainage. Improper drain piping may result in water leakage and property damage.
 - Insulate piping to prevent condensation.
 - Be careful when transporting the product.
 - Do not turn off the power immediately after stopping operation. Always wait for at least 5 minutes before turning off the power. Otherwise, water leakage may occur.
 - Do not use a charging cylinder. Using a charging cylinder may cause the refrigerant to deteriorate.
 - Refrigerant R410A in the system must be kept clean, dry, and tight.
 - (a) Clean and Dry -- Foreign materials (including mineral oils such as SUNISO oil or moisture) should be prevented from getting into the system.
- (b) Tight -- R410A does not contain any chlorine, does not destroy the ozone layer, and does not reduce the earth's protection against harmful ultraviolet radiation. R410A can contribute to the greenhouse effect if it is released. Therefore take proper measures to check for the tightness of the refrigerant piping installation. Read the chapter *Refrigerant Piping Work* and follow the procedures.
- Since R410A is a blend, the required additional refrigerant must be charged in its liquid state. If the refrigerant is charged in a state of gas, its composition can change and the system will not work properly.
 - The indoor unit is for R410A. See the catalog for outdoor models that can be connected. Normal operation is not possible when connected to non-compatible outdoor units.
 - Remote controller (wireless kit) transmitting distance can be shorter than expected in rooms with electronic fluorescent lamps (inverter or rapid start types). Install the indoor unit far away from fluorescent lamps as much as possible.
 - Indoor units are for indoor installation only. Outdoor units can be installed either outdoors or indoors.
 - Do not install the air conditioner or heat pump in the following locations:
 - (a) Where a mineral oil mist or oil spray or vapor is produced, for example, in a kitchen. Plastic parts may deteriorate and fall off or result in water leakage.
 - (b) Where corrosive gas, such as sulfurous acid gas, is produced. Corroding copper pipes or soldered parts may result in refrigerant leakage.
 - (c) Near machinery emitting electromagnetic waves. Electromagnetic waves may disturb the operation of the control system and cause the unit to malfunction.
 - (d) Where flammable gas may leak, where there is carbon fiber, or ignitable dust suspension in the air, or where volatile flammables such as thinner or gasoline are handled. Operating the unit in such conditions can cause a fire.
 - Take adequate measures to prevent the outdoor unit from being used as a shelter by small animals. Small animals making contact with electrical parts can cause malfunctions, smoke, or fire. Instruct the user to keep the area around the unit clean.
 - Servicing shall be performed only as recommended by the manufacturer and licensed or certified in their jurisdiction.







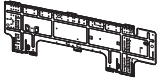

NOTE

- The indoor unit should be positioned where the unit and inter-unit wires (outdoor to indoor) are at least 3.3ft (1m) away from any televisions or radios. (The unit may cause interference with the picture or sound.) Depending on the radio waves, a distance of 3.3ft (1m) may not be sufficient to eliminate the noise.
- Dismantling the unit, treatment of the refrigerant, oil and additional parts must be done in accordance with the relevant local, state, and national regulations.
- Only use tools for R410A, such as a gauge manifold, charge hose, gas leak detector, reverse flow check valve, refrigerant charge base, vacuum gauge, or refrigerant recovery equipment.
- If the conventional refrigerant and refrigerator oil are mixed in R410A, the refrigerant may deteriorate.
- This air conditioner or heat pump is an appliance that should not be accessible to the general public.
- As maximum allowable pressure is 604psi (4.17MPa), the wall thickness of field-installed pipes should be selected in accordance with the relevant local, state, and national regulations.

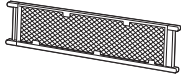
FTN005-U

2

Accessories

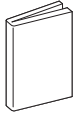
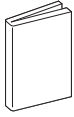
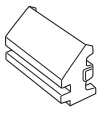
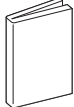
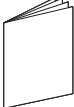
(A) Mounting plate 	1	(B) Mounting plate fixing screw M4 × 1" (M4 × 25mm) 	9	(C) Titanium apatite deodorizing filter 	2
(D) Wireless remote controller 	1	(E) Remote controller holder 	1	(F) Remote controller holder fixing screw M3 × 13/16" (M3 × 20mm) 	2
(G) Dry battery AAA. LR03 (alkaline) 	2	(H) Indoor unit fixing screw M4 × 1/2" (M4 × 12mm) 	2	(J) Tube 	1
(K) Operation manual 	1	(L) Installation manual 	1	(M) Screw cover 	3
(N) General safety considerations 	1	(P) Warranty 	1		

Choosing an Installation Site

- Before choosing the installation site, obtain user approval.

1. Indoor unit

- The indoor unit should be positioned in a place where:
 - 1) the restrictions on the installation requirements specified in “**Indoor Unit Installation**” on page 4 are met,
 - 2) both the air inlet and air outlet are unobstructed,
 - 3) the unit is not exposed to direct sunlight,
 - 4) Install so that drainage occurs easily,
 - 5) the unit is away from sources of heat or steam,
 - 6) there is no source of machine oil vapor (this may shorten the indoor unit service life),
 - 7) cool/warm air is circulated throughout the room,
 - 8) the unit is away from electronic ignition type fluorescent lamps (inverter or rapid start type) as they may affect the remote controller range,
 - 9) no laundry equipment is nearby.

2. Wireless remote controller

- Turn on all the fluorescent lamps in the room, if any, and find a location where the remote controller signals are properly received by the indoor unit (within 23ft (7m)).

Indoor Unit Installation

⚠ CAUTION

- Do not hit or forcefully push the INTELLIGENT EYE sensor. This can lead to damage and malfunction.
- Do not place large objects near the sensor. Also keep heating units or humidifiers outside the sensor's detection area.

- **How to attach the indoor unit**
Hook the claws of the bottom frame to the mounting plate.
If the claws are difficult to hook, remove the front grille.
- **How to remove the indoor unit**
Push up the marked area (at the lower part of the front grille) to release the claws. If it is difficult to release, remove the front grille.

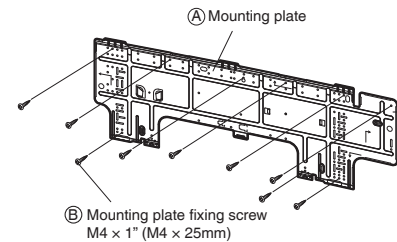
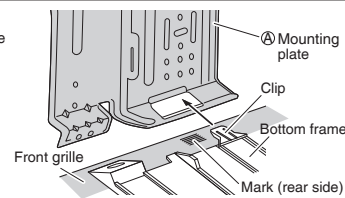

The mounting plate should be installed on a wall which can support the weight of the indoor unit.

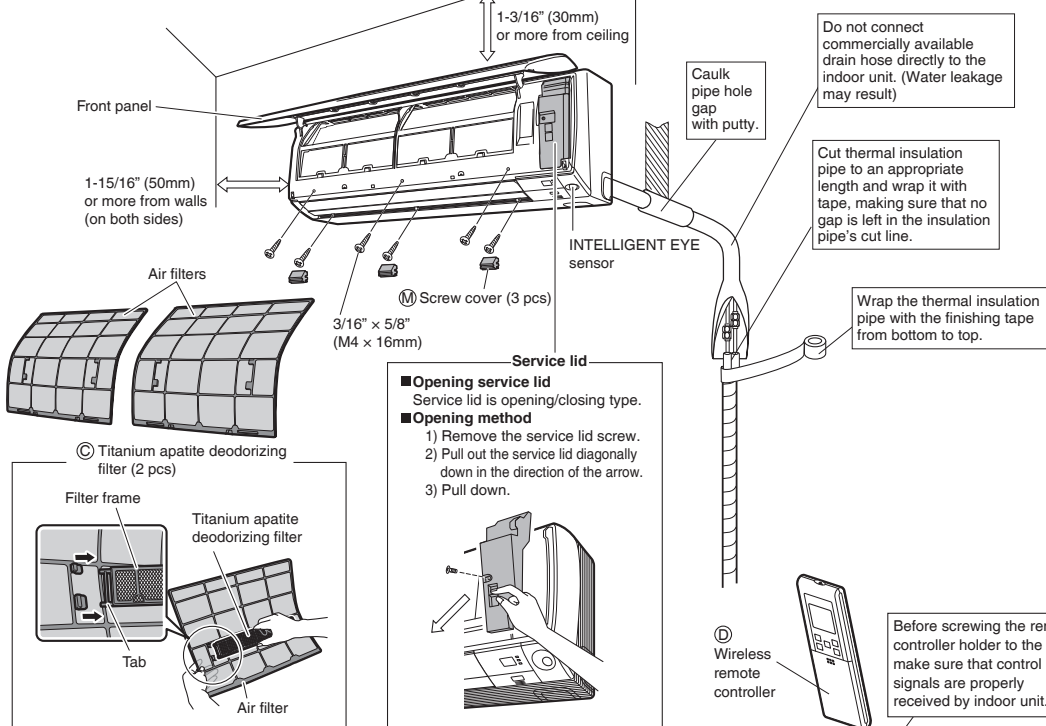

- **Opening service lid**
Service lid is opening/closing type.
- **Opening method**
 - 1) Remove the service lid screw.
 - 2) Pull out the service lid diagonally down in the direction of the arrow.
 - 3) Pull down.

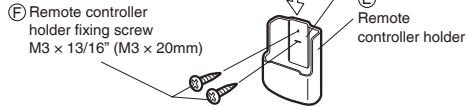
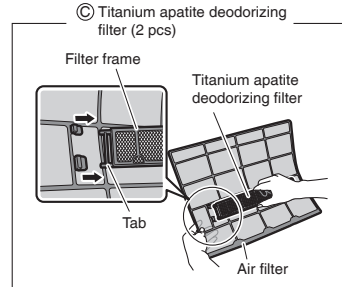
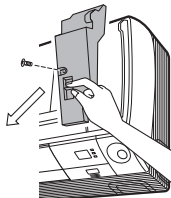

Before screwing the remote controller holder to the wall, make sure that control signals are properly received by indoor unit.

Indoor Unit Installation

1. Installing the mounting plate

- The mounting plate should be installed on a wall which can support the weight of the indoor unit.
 - Temporarily secure the mounting plate to the wall, make sure that the plate is completely level, and mark the drilling points on the wall.
 - Secure the mounting plate to the wall with screws.

Recommended mounting plate retention spots and dimensions

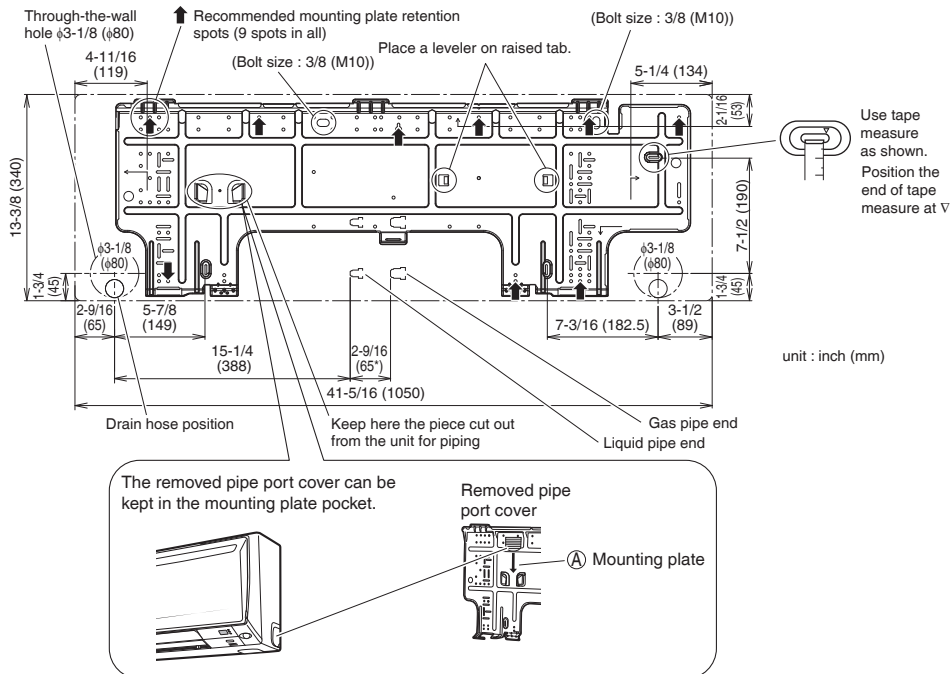

* Depending on the model, the actual distance between the liquid pipe end and gas pipe end may differ from the distance between those symbols on the mounting plate (the distance listed in this manual). Always measure the actual distance between the liquid pipe end and gas pipe end before installing refrigerant pipes.

2. Drilling a wall hole and installing wall embedded pipe

⚠ WARNING

For metal frame or metal board walls, be sure to use a wall embedded pipe and wall hole cover in the feed-through hole to prevent possible heat, electric shock, or fire.

- Be sure to caulk the gaps around the pipes with caulking material. (to prevent condensation caused by intrusion of air from outside or within the wall)
 - Drill a feed-through hole with a $\phi 3-1/8$ "(80mm) diameter through the wall at a downward angle toward the outside. (to prevent water leakage)
 - Insert a wall embedded pipe into the hole.
 - Insert a wall hole cover into wall pipe.
 - After completing refrigerant piping, wiring, and drain piping, caulk the pipe hole gap with putty.

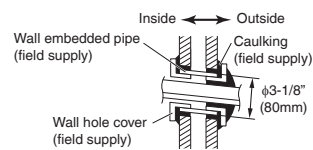

Even if a wall hole cover is not used, caulk both the outdoor and indoor sides with putty.

3. Installing the indoor unit

In the case of bending or curing refrigerant pipes, keep the following precautions in mind.

Abnormal sound may be generated if improper work is conducted.

- Do not strongly press the refrigerant pipes onto the bottom frame.
- Do not strongly press the refrigerant pipes on the front grille, either.

3-1. Right-side, right-back, or right-bottom piping

- 1) Attach the drain hose to the underside of the refrigerant pipes with adhesive vinyl tape.
- 2) Wrap the refrigerant pipes and drain hose together with insulation tape.

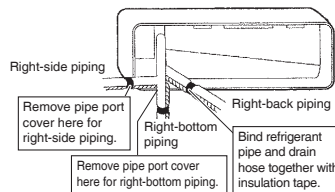

- 3) Pass the drain hose and refrigerant pipes through the wall hole, then position the indoor unit on the (A) mounting plate hooks by using the △ markings at the top of the indoor unit as a guide.

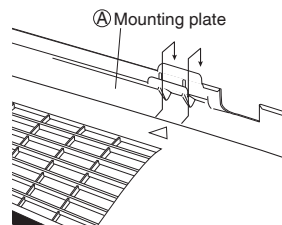

- 4) Open the front panel, then open the service lid (Refer to “Indoor Unit Installation” on page 4).
- 5) Pass the inter-unit wire from the outdoor unit through the feed-through wall hole and pass to the front of indoor unit from the back. Then pull them at front side. Bend the ends of cable tie wires upward for easier work in advance. (If the inter-unit wire ends are to be stripped first, bundle wire ends with adhesive tape.)
- 6) Press the bottom frame of the indoor unit with both hands until it is firmly caught by the (A) mounting plate hooks. Make sure the wire leads do not catch on the edge of the indoor unit.

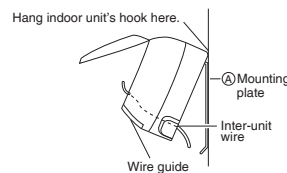

3-2. Left-side, left-back, or left-bottom piping

- 1) Switch around the drain plug and drain hose.

How to switch around the drain plug and drain hose

1) Remove the fixing screw and pull out the drain hose.

① Remove fixing screw.
Drain hose

② Pull out drain hose.

2) Pull out drain plug.

3) Switch around the drain hose and drain plug.

Drain plug

Hexagonal wrench (3/16 inch (4mm))

Push the drain plug all the way in using a hexagonal wrench (3/16 inch (4mm)).

No gap

Do not apply lubricating oil (refrigerant oil) to the drain plug when inserting it. The application of lubrication oil to the drain plug will deteriorate the plug to cause drain leakage from the plug.

Insert a hexagonal wrench (3/16 inch (4mm)).

Insert drain hose securely and fix in place with fixing screw.

Fixing screw

Drain hose

Indoor Unit Installation

- 2) Attach the drain hose to the underside of the refrigerant pipes with adhesive vinyl tape.

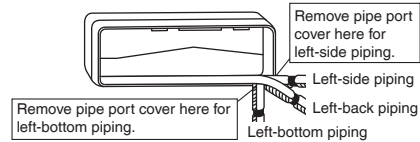

- 3) Shape the refrigerant pipes along the pipe path marking on the (A) mounting plate.

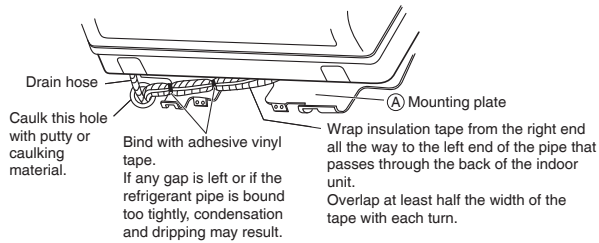

- 4) Pass the drain hose and refrigerant pipes through the wall hole, then position the indoor unit on the (A) mounting plate hooks, using the △ markings at the top of the indoor unit as a guide.

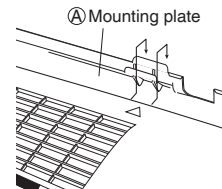

- 5) Open the front panel (Refer to “Installation Tips” on page 11), then open the service lid (Refer to “Indoor Unit Installation” on page 4).

- 6) Pass the inter-unit wire from the outdoor unit through the feed-through wall hole and pass to the front of indoor unit from the back. Then pull them at front side. Bend the ends of cable tie wires upward for easier work in advance. (If the inter-unit wire ends are to be stripped first, bundle wire ends with adhesive tape.)

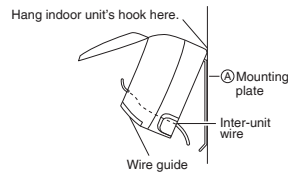

- 7) Connect the refrigerant pipes.
- 8) In case of pulling the drain hose through the back of the indoor unit, wrap the refrigerant pipes and drain hose together with insulation tape as shown in the right figure.
- 9) Press the bottom frame of the indoor unit with both hands until it is firmly caught by the (A) mounting plate hooks. Make sure that the wires do not catch on the edge of the indoor unit.

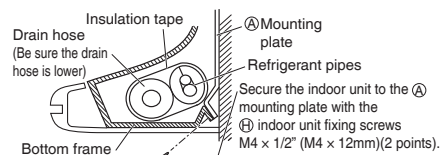

Wrap with vinyl tape so that no gap is left and the slit in the thermal insulation pipe is facing upward.



3-3. Wall embedded piping

Follow the instructions given under left-side, left-back, or left-bottom piping.

- 1) Insert the drain hose to a depth of 1-15/16 inches (50mm) or more so it will not be pulled out of the drain pipe.

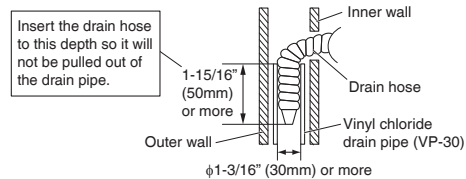

4. Wiring

Refer to the installation manual for the outdoor unit also.

⚠ WARNING

- Do not use tapped wires, extension cords, or starburst connections, as they may cause overheating, electric shock, or fire.
- Do not use locally purchased electrical parts inside the product. (Do not branch the power for the drain pump, etc., from the terminal block.) Doing so may cause electric shock or fire.
- Do not connect the power wire to the indoor unit. Doing so may cause electric shock or fire.

⚠ CAUTION

Recommend stranded cable for interunit wiring. Local code always supersedes recommendation.

- For stranded wires, make sure to use the round crimp-style terminal for connection to the power supply terminal block. Place the round crimp-style terminals on the wires up to the covered part and secure in place.

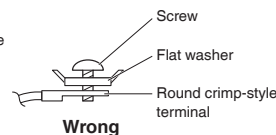
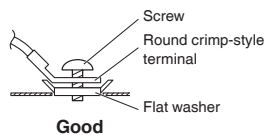
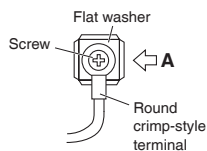
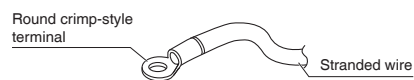

Arrow view A

- If solid core wire must be used, be sure to curl the end of the lead. Improper work may cause heat and fire.

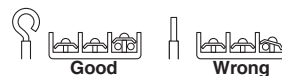

With a multi indoor unit, install as described in the installation manual supplied with the Multi outdoor unit.

- 1) As shown in the illustration on the right-hand side, insert the wires including the ground wire into the conduit and secure them with lock nut onto the conduit mounting plate.
- 2) Insert the wires including the ground wire into (J) tube.
- 3) Strip wire ends (3/4 inch (20mm)).
- 4) Match wire colors with terminal numbers on indoor and outdoor unit's terminal blocks and firmly screw wires to the corresponding terminals.
- 5) Connect the ground wires to the corresponding terminals.
- 6) Pull the wires and check that the wires are securely fixed to the terminal block.
- 7) In case of connecting to an adapter system, run the remote controller cable and attach the S21. (Refer to P12 when connecting to an HA system.)
- 8) Shape the wires so that the service lid fits securely, then close service lid.

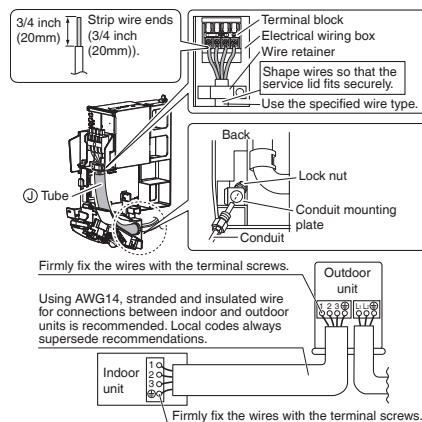

Indoor Unit Installation

5. Drain piping

- 1) Connect the drain hose, as described on the right.
 - Avoid placing the end of the drain hose in a drainage location that could cause bad odors or corrosive gas to flow backward into the outlet.
 - The drainage water may change color due to bacteria or other organisms. Place in a location where the flow of drainage water will not cause a problem.
 - Minimize the number of bends in the drain hose as much as possible. If bending the drain hose, bend it gently.
- 2) Remove the air filters and transfer some water to the indoor heat exchanger by pouring water into the drain pan.
- 3) Make sure that water flows out of the drain hose.
- 4) If drain hose extension or embedded drain piping is required, use appropriate parts that match the hose front end.

Figure of hose front end

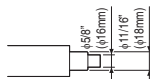

- When drain hose requires extension, obtain an extension hose with an inner diameter of 5/8 inch (16mm). Be sure to thermally insulate the indoor section of the extension hose.
- When connecting a rigid polyvinyl chloride pipe (nominal diameter 1/2 inch (13mm)) directly to the drain hose attached to the indoor unit as with embedded piping work, use any commercially available drain socket (nominal diameter 1/2 inch (13mm)) as a joint.

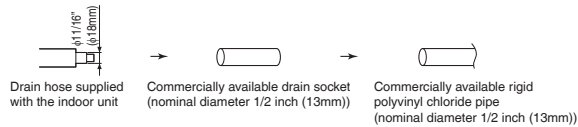
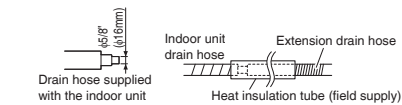
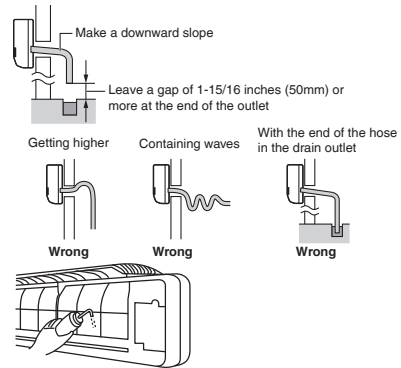

Refrigerant Piping Work

⚠ WARNING

- Do not apply mineral oil to the flare.
- Prevent mineral oil from getting into the system as this would reduce the service life of the units.
- Never use piping which has been used for previous installations. Only use parts which are delivered with this unit.
- Never install a dryer to this R410A unit in order to guarantee its service life.
- The drying material may dissolve and damage the system.
- Improper flaring may result in refrigerant gas leakage.

1. Flaring the pipe end

- 1) Cut the pipe end with a pipe cutter.
- 2) Remove burrs with the cut surface facing downward, so that the filings do not enter the pipe.



- 3) Put the flare nut on the pipe.
- 4) Flare the pipe.
- 5) Check that the flaring has been done correctly.

Set exactly at the position shown below.

Flare tool for R410A	Conventional flare tool		
	Clutch-type	Clutch-type (Rigid-type)	Wing-nut type (Imperial-type)
A	0-0.020 inch (0-0.5mm)	0.039-0.059 inch (1.0-1.5mm)	0.059-0.079 inch (1.5-2.0mm)

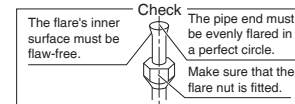

2. Refrigerant piping

⚠ CAUTION

- Use the flare nut fixed to the main unit. (This is to prevent the flare nut from cracking as a result of deterioration over time.)
- To prevent gas leakage, apply refrigeration oil only to the inner surface of the flare. (Use refrigeration oil for R410A.)
- Use a torque wrench when tightening the flare nuts to prevent damage to the flare nuts and gas leakage.

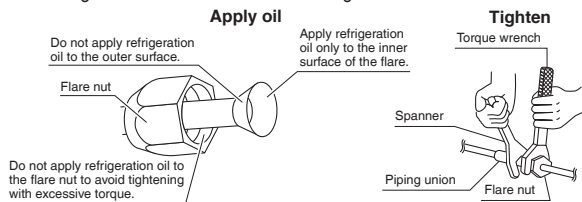

	Piping size	Flare nut tightening torque
Gas side	O.D. 1/2 inch (12.7mm)	36-1/2 – 44-1/2 lbf • ft (49.5-60.3N • m)
	O.D. 5/8 inch (15.9mm)	45-5/8 – 55-5/8 lbf • ft (61.8-75.4N • m)
Liquid side	O.D. 1/4 inch (6.4mm)	10-1/2 – 12-3/4 lbf • ft (14.2-17.2 N • m)

Caution on piping handling

- Protect the open end of the pipe against dust and moisture.
- All pipe bends should be as gentle as possible. Use a pipe bender for bending.

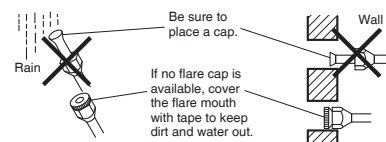

Selection of copper and heat insulation materials

When using commercial copper pipes and fittings, observe the following:

- Insulation material: Polyethylene foam
Heat transfer rate: 0.041 to 0.052W/mK (0.024 to 0.030Btu/ft²•F (0.035 to 0.045kcal/mh²•C))
Be sure to use insulation that is designed for use with HVAC Systems.
- ACR Copper only.

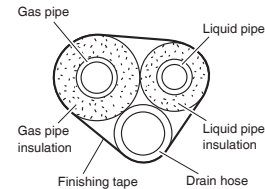

- Be sure to insulate both the gas and liquid piping and observe the insulation dimensions as below.

	Piping size	Minimum bend radius	Piping thickness	Thermal insulation size	Thermal insulation thickness
Gas side	O.D. 1/2 inch (12.7mm) or more	1-9/16 inch (40mm) or more	0.031 inch (0.8mm) (C1220T-O)	I.D. 9/16-5/8 inch (14-16mm)	13/32 inch (10mm) Min.
	O.D. 5/8 inch (15.9mm)	1-15/16 inch (50mm) or more	0.039 inch (1.0mm) (C1220T-O)	I.D. 5/8-13/16 inch (16-20mm)	
Liquid side	O.D. 1/4 inch (6.4mm)	1-3/16 inch (30mm) or more	0.031 inch (0.8mm) (C1220T-O)	I.D. 5/16-13/32 inch (8-10mm)	

- Use separate thermal insulation pipes for gas and liquid refrigerant pipes.
- Using finishing tape, bundle and wrap the indoor unit piping and drain hose together so that the drain hose is below the other piping.

Installation Tips

1. Removing and installing front panel

• Removal method

- 1) Place your fingers in the indentations on the main unit (one each on the left and right sides), and open the front panel until it stops.
- 2) While pushing the left side front panel shaft outward, push up the front panel and remove it. (Remove the right side front panel shaft in the same manner.)
- 3) After removing both front panel shafts, pull the front panel toward yourself and remove it.

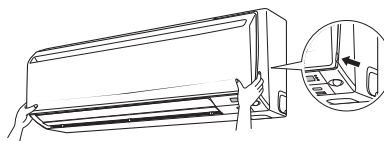

• Installation method

Align the tabs of the front panel with the grooves, and push all the way in. Then close slowly. Push the center of the lower surface of the panel firmly to engage the tabs.

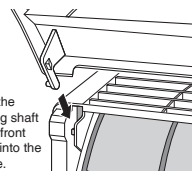
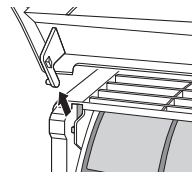

Push the rotating shaft of the front panel into the groove.

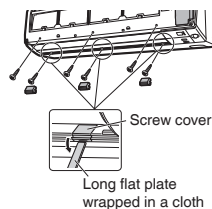

Fig.1

2. Removing and installing the front grille

• Removal method

- 1) Remove the front panel and air filters.
- 2) Remove screw covers (3 pcs.). (See Fig.1)
- 3) Remove the front grille fixing screws (6 screws). (See Fig.1)
- 4) Remove the service lid screw (1 screw) and remove service lid. (See Fig.2)
- 5) In front of the ○○○ mark on the front grille, there are 3 upper hooks. Lightly pull the front grille toward you with one hand, and push down on the hooks with the fingers of your other hand. (See Fig.3)

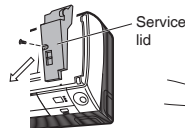

Fig.2

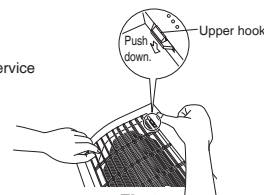

Fig.3

When there is insufficient work space because the unit is close to ceiling

Place both hands under the center of the front grille, and while pushing up, pull it toward you.

• Installation method

- 1) Install the front grille and firmly engage the upper hooks (3 locations).
- 2) Install the 6 screws of the front grille and screw covers (3 pcs.).
- 3) Install the service lid and screw for fixing the service lid (1 screw).
- 4) Install the air filters and then mount the front panel.

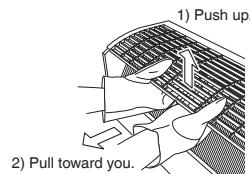

CAUTION

- Be sure to wear protection gloves.

3. How to set the different addresses

When 2 indoor units are installed in one room, the 2 wireless remote controllers can be set for different addresses.

- 1) Remove the metal plate electrical wiring cover.
(Refer to the **When connecting to an HA system.**)
- 2) Cut the address jumper (JA) on the printed circuit board.
- 3) Cut the address jumper (J4) in the remote controller.

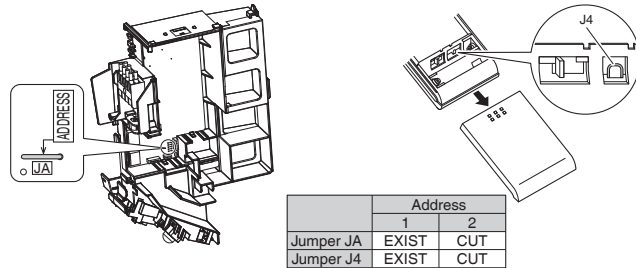

4. When connecting to an HA system

For this procedure, accessories which are sold separately are needed. (wired remote controller, central remote controller, etc.)

- 1) Remove the front grille.
(Refer to **“Removing and installing the front grille”** on page 11.)
- 2) Remove electrical wiring box. (1 screw)
- 3) Remove the metal plate electrical wiring cover. (4 tabs)

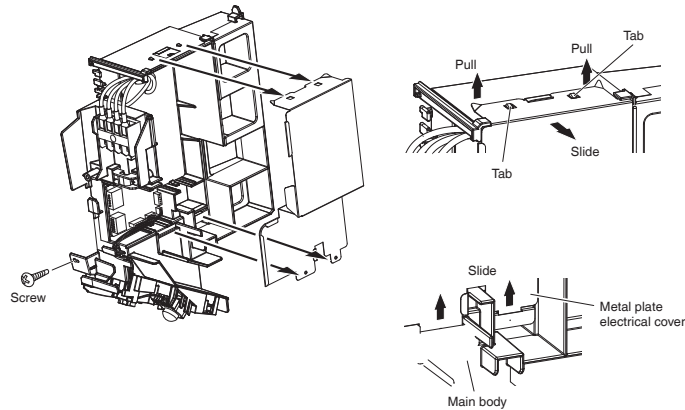

- 4) Attach the connection cord to the S21 connector and pull the harness out through the notched part in the figure.
- 5) Replace the electrical wiring cover as it was, and pull the harness around, as shown in the figure.

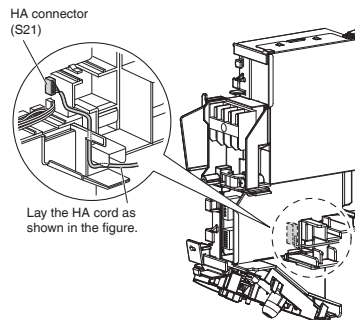

Trial Operation and Testing

1. Trial operation and testing

- Trial operation should be carried out in either COOL or HEAT operation.

1-1. Measure the supply voltage and make sure that it is within the specified range.



1-2. In COOL operation, select the lowest programmable temperature; in HEAT operation, select the highest programmable temperature.

1-3. Carry out the trial operation following the instructions in the operation manual to ensure that all functions and parts, such as the movement of the flap, are working properly.

- To protect the air conditioner, restart operation is disabled for 3 minutes after the system has been turned off.

1-4. After trial operation is complete, set the temperature to a normal level (78°F to 82°F (26°C to 28°C) in COOL operation, 68°F to 75°F (20°C to 24°C) in HEAT operation).

- When operating the air conditioner in COOL operation in winter, or HEAT operation in summer, set it to the trial operation mode using the following method.

- 1) Press  button (2 locations) and **MODE** button at the same time.
- 2) Press **MODE** button twice.
(" ? " will appear on the display to indicate that trial operation mode is selected.)
- 3) Press **MODE** and select the COOL or HEAT operation.
- 4) Press  button to turn on the system.
 - Trial operation terminates in approx. 30 minutes and switches into normal mode.
 - To quit a trial operation, press  button.



HEAT PUMP model

- The air conditioner draws a small amount of power in its standby mode. If the system is not to be used for some time after installation, shut off the circuit breaker to eliminate unnecessary power consumption.
- If the circuit breaker trips to shut off the power to the air conditioner, the system will restore the original operation mode when the circuit breaker is turned on again.

2. Test items

Test items	Symptom	Check
Indoor and outdoor units are installed securely.	Fall, vibration, noise	
No refrigerant gas leaks.	Incomplete cooling/heating function	
Refrigerant gas and liquid pipes and indoor drain hose extension are thermally insulated.	Water leakage	
Draining line is properly installed.	Water leakage	
System is properly grounded.	Electrical leakage	
Only specified wires are used for all wiring, and all wires are connected correctly.	No operation or burn damage	
Indoor or outdoor unit's air inlet or air outlet are unobstructed.	Incomplete cooling/heating function	
Stop valves are opened.	Incomplete cooling/heating function	
Indoor unit properly receives remote control commands.	No operation	
The heat pump or cooling only mode is selectable with the DIP switch of the remote controller.	Remote controller malfunctioning	

1.3 FTXR

Contents

Safety Considerations	1	Refrigerant Piping Work	9
Accessories	3	1. Flaring the pipe end	10
Choosing an Installation Site	3	2. Refrigerant piping.....	10
1. Indoor unit.....	3	Installation Tips	11
2. Wireless remote controller	3	1. Removing and installing the upper front panel.....	11
Indoor Unit Installation Diagram	4	2. Removing and installing the front grille.....	11
Indoor Unit Installation	5	3. How to set the different addresses	12
1. Installing the mounting plate	5	4. When connecting a wireless LAN connecting adapter.....	12
2. Drilling a wall hole and installing wall embedded pipe... 5		5. When connecting to an HA system.....	13
3. Installing the indoor unit.....	6	Trial Operation and Testing	14
4. Wiring.....	8	1. Trial operation and testing	14
5. Drain piping.....	9	2. Test items	14

The pictures in this document are for illustrative purposes only.

Safety Considerations

Refer also to the General Safety Considerations in the separate booklet.







Read the precautions in this manual carefully before operating the unit.

Read these **Safety Considerations for Installation** carefully before installing an air conditioner or heat pump. After completing the installation, make sure that the unit operates properly during the startup operation.

Instruct the user on how to operate and maintain the unit. Inform users that they should store this installation manual with the operation manual for future reference.

Always use a licensed installer or contractor to install this product. Improper installation can result in water or refrigerant leakage, electric shock, fire, or explosion.

Meanings of **DANGER**, **WARNING**, **CAUTION**, and **NOTE** Symbols:

-  **DANGER**Indicates an imminently hazardous situation which, if not avoided, will result in death or serious injury.
-  **WARNING**Indicates a potentially hazardous situation which, if not avoided, could result in death or serious injury.
-  **CAUTION**Indicates a potentially hazardous situation which, if not avoided, may result in minor or moderate injury. It may also be used to alert against unsafe practices.
-  **NOTE**Indicates situations that may result in equipment or property damage accidents only.

 **DANGER** _____

- Refrigerant gas is heavier than air and replaces oxygen. A massive leak can lead to oxygen depletion, especially in basements, and an asphyxiation hazard could occur leading to serious injury or death.
- Do not ground units to water pipes, gas pipes, telephone wires, or lightning rods as incomplete grounding can cause a severe shock hazard resulting in severe injury or death. Additionally, grounding to gas pipes could cause a gas leak and potential explosion causing severe injury or death.

- If refrigerant gas leaks during installation, ventilate the area immediately. Refrigerant gas may produce toxic gas if it comes into contact with fire. Exposure to this gas could cause severe injury or death.
- After completing the installation work, check that the refrigerant gas does not leak throughout the system.
- Do not install unit in an area where flammable materials are present due to risk of explosions that can cause serious injury or death.
- Safely dispose all packing and transportation materials in accordance with federal/state/local laws or ordinances. Packing materials such as nails and other metal or wood parts, including plastic packing materials used for transportation may cause injuries or death by suffocation.

 **WARNING** _____

- Only qualified personnel licensed or certified in their jurisdiction must carry out the installation work. Installation must be done in accordance with this installation manual. Improper installation may result in water leakage, electric shock, or fire.
- When installing the unit in a small room, take measures to keep the refrigerant concentration from exceeding allowable safety limits. Excessive refrigerant leaks, in the event of an accident in a closed ambient space, can lead to oxygen deficiency.
- Use only specified accessories and parts for installation work. Failure to use specified parts may result in water leakage, electric shock, fire, or the unit falling.
- Install the air conditioner or heat pump on a foundation strong enough that it can withstand the weight of the unit. A foundation of insufficient strength may result in the unit falling and causing injuries.
- Take into account strong winds, typhoons, or earthquakes when installing. Improper installation may result in the unit falling and causing accidents.
- Make sure that a separate power supply circuit is provided for this unit and that all electrical work is carried out by qualified personnel licensed or certified in their jurisdiction according to local, state, and national regulations. An insufficient power supply capacity or improper electrical construction may lead to electric shock or fire.
- Make sure that all wiring is secured, that specified wires are used, and that no external forces act on the terminal connections or wires. Improper connections or installation may result in fire.

- When wiring, position the wires so that the electrical wiring box cover can be securely fastened. Improper positioning of the electrical wiring box cover may result in electric shock, fire, or the terminals overheating.
- Before touching electrical parts, turn off the unit.
- The circuit must be protected with safety devices in accordance with local and national codes, i.e. a circuit breaker.
- Securely fasten the outdoor unit terminal cover (panel). If the terminal cover/panel is not installed properly, dust or water may enter the outdoor unit causing fire or electric shock.
- When installing or relocating the system, keep the refrigerant circuit free from substances other than the specified refrigerant (R410A) such as air. Any presence of air or other foreign substance in the refrigerant circuit can cause an abnormal pressure rise or rupture, resulting in equipment damage and even injury.
- Do not change the setting of the protection devices. If the pressure switch, thermal switch, or other protection device is shorted and operated forcibly, or parts other than those specified by Daikin are used, fire or explosion may occur.
- Do not use means to accelerate the defrosting process (if possible) or to clean, other than those recommended by the manufacturer.
- The appliance must be stored in a room without continuously operating ignition sources (for example: open flames, an operating gas appliance or an operating electric heater).
- Do not pierce or burn.
- Be aware that refrigerants may not contain an odor.
- Comply with national gas regulations.

⚠ CAUTION

- Do not touch the switch with wet fingers. Touching a switch with wet fingers can cause electric shock.
- Do not allow children to play on or around the unit to prevent injury.
- Wear adequate personal protective equipment (protective gloves, safety glasses,...) when installing, maintaining or servicing the system.
- The heat exchanger fins are sharp enough to cut. To avoid injury, wear gloves or cover the fins while working around them.
- Do not touch the refrigerant pipes during and immediately after operation as the refrigerant pipes may be hot or cold, depending on the condition of the refrigerant flowing through the refrigerant piping, compressor, and other refrigerant cycle parts. Your hands may suffer burns or frostbite if you touch the refrigerant pipes. To avoid injury, give the pipes time to return to normal temperature or, if you must touch them, be sure to wear proper gloves.
- Install drain piping to ensure proper drainage. Improper drain piping may result in water leakage and property damage.
- Insulate piping to prevent condensation.
- Be careful when transporting the product.
- Do not turn off the power immediately after stopping operation. Always wait for at least 5 minutes before turning off the power. Otherwise, water leakage may occur.
- Do not use a charging cylinder. Using a charging cylinder may cause the refrigerant to deteriorate.
- Refrigerant R410A in the system must be kept clean, dry, and tight.
 - (a) Clean and Dry -- Foreign materials (including mineral oils such as SUNISO oil or moisture) should be prevented from getting into the system.
 - (b) Tight -- R410A does not contain any chlorine, does not destroy the ozone layer, and does not reduce the earth's protection against harmful ultraviolet radiation. R410A can contribute to the greenhouse effect if it is released. Therefore take proper measures to check for the tightness of the refrigerant piping installation. Read the chapter *Refrigerant Piping Work* and follow the procedures.
- Since R410A is a blend, the required additional refrigerant must be charged in its liquid state. If the refrigerant is charged in a state of gas, its composition can change and the system will not work properly.
- The indoor unit is for R410A. See the catalog for outdoor models that can be connected. Normal operation is not possible when connected to non-compatible outdoor units.
- Remote controller (wireless kit) transmitting distance can be shorter than expected in rooms with electronic fluorescent lamps (inverter or rapid start types). Install the indoor unit far away from fluorescent lamps as much as possible.
- Indoor units are for indoor installation only. Outdoor units can be installed either outdoors or indoors.
- Do not install the air conditioner or heat pump in the following locations:
 - (a) Where a mineral oil mist or oil spray or vapor is produced, for example, in a kitchen. Plastic parts may deteriorate and fall off or result in water leakage.
 - (b) Where corrosive gas, such as sulfurous acid gas, is produced. Corroding copper pipes or soldered parts may result in refrigerant leakage.
 - (c) Near machinery emitting electromagnetic waves. Electromagnetic waves may disturb the operation of the control system and cause the unit to malfunction.
 - (d) Where flammable gas may leak, where there is carbon fiber, or ignitable dust suspension in the air, or where volatile flammables such as thinner or gasoline are handled. Operating the unit in such conditions can cause a fire.
- Take adequate measures to prevent the outdoor unit from being used as a shelter by small animals. Small animals making contact with electrical parts can cause malfunctions, smoke, or fire. Instruct the user to keep the area around the unit clean.
- Servicing shall be performed only as recommended by the manufacturer and licensed or certified in their jurisdiction.











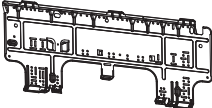

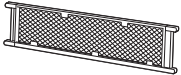
⚠ NOTE

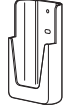
- The indoor unit should be positioned where the unit and inter-unit wires (outdoor to indoor) are at least 3.3ft (1m) away from any televisions or radios. (The unit may cause interference with the picture or sound.) Depending on the radio waves, a distance of 3.3ft (1m) may not be sufficient to eliminate the noise.
- Dismantling the unit, treatment of the refrigerant, oil and additional parts must be done in accordance with the relevant local, state, and national regulations.
- Only use tools for R410A, such as a gauge manifold, charge hose, gas leak detector, reverse flow check valve, refrigerant charge base, vacuum gauge, or refrigerant recovery equipment.
- If the conventional refrigerant and refrigerator oil are mixed in R410A, the refrigerant may deteriorate.
- This air conditioner or heat pump is an appliance that should not be accessible to the general public.
- As maximum allowable pressure is 604psi (4.17MPa), the wall thickness of field-installed pipes should be selected in accordance with the relevant local, state, and national regulations.

FTN005-U

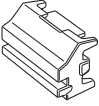
2

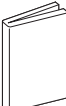
Accessories

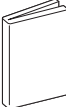
A Mounting plate 	1	B Mounting plate fixing screw M4 x 1" (M4 x 25mm) 	5	C Titanium apatite deodorizing filter 	2
D Wireless remote controller 	1	E Remote controller holder 	1	F Remote controller holder fixing screw M3 x 13/16" (M3 x 20mm) 	2
G Dry battery AAA. LR03 (alkaline) 	2	H Indoor unit fixing screw M4 x 1/2" (M4 x 12mm) 	2	J Screw cover 	2
K Insulation tape 	1	L Operation manual 	1	M Installation manual 	1
N Warranty 	1	P General safety considerations 	1		

Choosing an Installation Site

Before choosing the installation site, obtain user approval.

1. Indoor unit

- The indoor unit should be positioned in a place where:
 - 1) the restrictions on the installation requirements specified in "Indoor Unit Installation Diagram" on page 4 are met,
 - 2) both the air inlet and air outlet are unobstructed,
 - 3) the unit is not exposed to direct sunlight,
 - 4) Install so that drainage occurs easily,
 - 5) the unit is away from sources of heat or steam,
 - 6) there is no source of machine oil vapor (this may shorten the indoor unit service life),
 - 7) cool/warm air is circulated throughout the room,
 - 8) the unit is away from electronic ignition type fluorescent lamps (inverter or rapid start type) as they may affect the remote controller range,
 - 9) no laundry equipment is nearby.

2. Wireless remote controller

Turn on all the fluorescent lamps in the room, if any, and find a location where the remote controller signals are properly received by the indoor unit (within 19-11/16ft (6m)).

Indoor Unit Installation Diagram

⚠ CAUTION

- Do not hit or violently push the INTELLIGENT EYE sensor. This can lead to damage and malfunction.
- Do not place large objects near the INTELLIGENT EYE sensor. Also keep heating units or humidifiers outside the sensor's detection area.

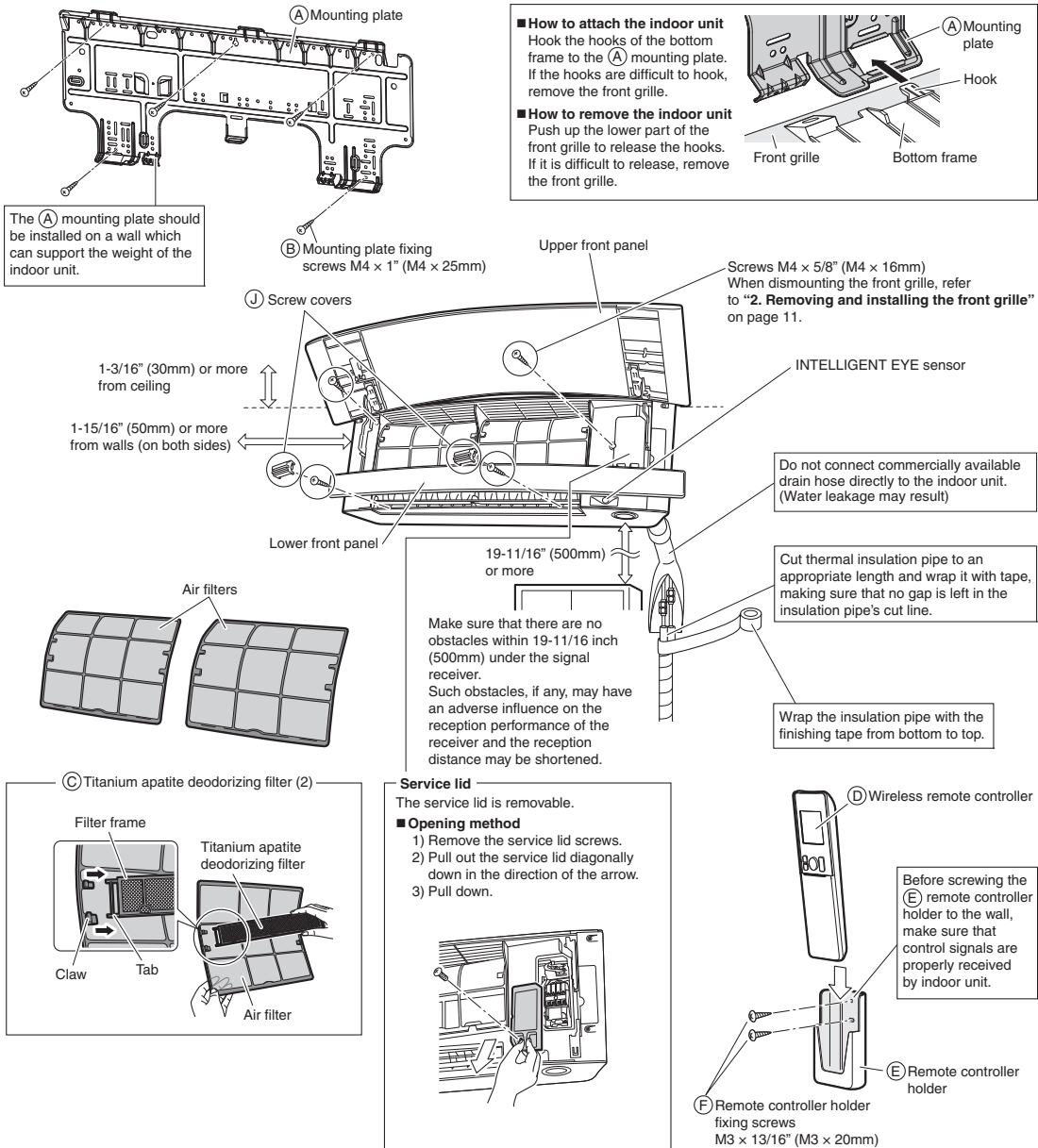

Indoor Unit Installation

1. Installing the mounting plate

The mounting plate should be installed on a wall which can support the weight of the indoor unit.

- 1) Temporarily secure the mounting plate to the wall, make sure that the plate is completely level, and mark the drilling points on the wall.
- 2) Secure the mounting plate to the wall with screws.

Recommended mounting plate retention spots and dimensions

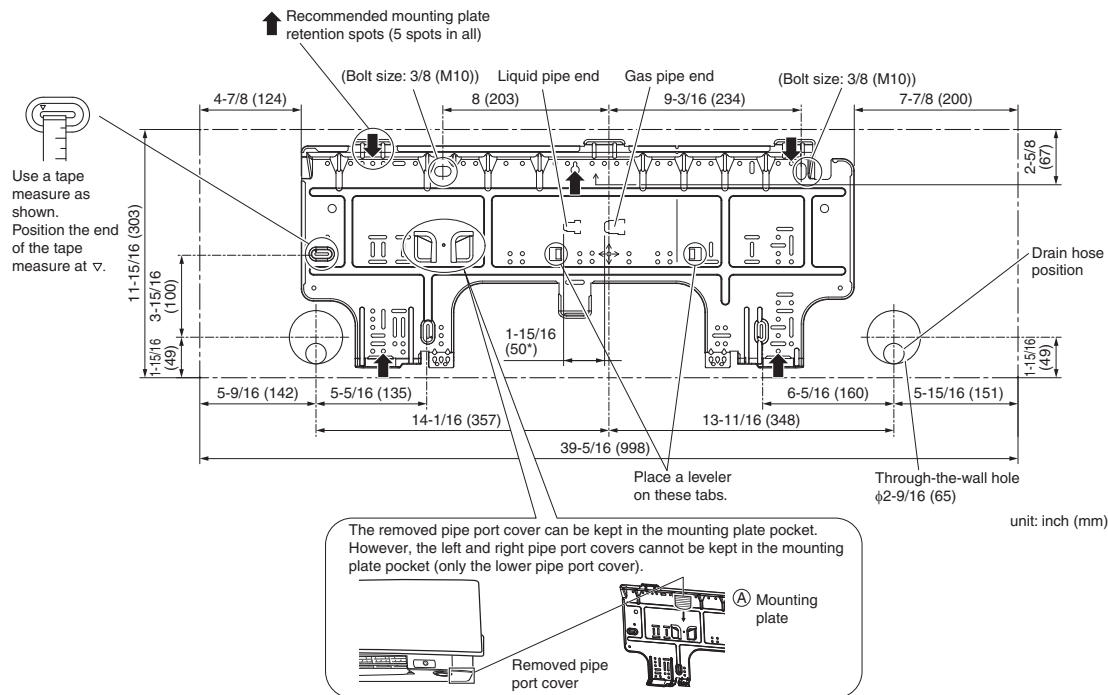

* Depending on the model, the actual distance between the liquid pipe end and gas pipe end may differ from the distance between those symbols on the mounting plate (the distance listed in this manual).
Always measure the actual distance between the liquid pipe end and gas pipe end before installing refrigerant pipes.

2. Drilling a wall hole and installing wall embedded pipe

⚠ WARNING

For metal frame or metal board walls, be sure to use a wall embedded pipe and wall hole cover in the feed-through hole to prevent possible heat, electric shock, or fire.

- Be sure to caulk the gaps around the pipes with caulking material. (to prevent condensation caused by intrusion of air from outside or within the wall)
- 1) Drill a feed-through hole with a $\phi 2-9/16$ inch (65mm) diameter through the wall at a downward angle toward the outside.
 - 2) Insert a wall embedded pipe into the hole.
 - 3) Insert a wall hole cover into wall pipe.
 - 4) After completing refrigerant piping, wiring, and drain piping, caulk the pipe hole gap with putty.

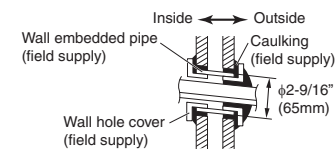

Even if a wall hole cover is not used, caulk both the outdoor and indoor sides with putty.

3. Installing the indoor unit

- The recommended installation method is back piping.
- **When performing bottom piping or left side piping, refer to “3-2. Left-side, left-back, or left-bottom piping”.**
- Right side piping cannot be performed.
- In the case of bending or curing refrigerant pipes, keep the following precautions in mind.
 - Abnormal sound may be generated if improper work is conducted.
 - Do not strongly press the refrigerant pipes onto the bottom frame.
 - Do not strongly press the refrigerant pipes on the front grille, either.

3-1. Right-back or right-bottom piping

- 1) Attach the drain hose to the underside of the refrigerant pipes with adhesive vinyl tape.
- 2) Wrap the refrigerant pipes and drain hose together with (K) insulation tape.
- 3) Pass the drain hose and refrigerant pipes through the wall hole, then position the indoor unit on the (A) mounting plate hooks, using the Δ markings at the top of the indoor unit as a guide.

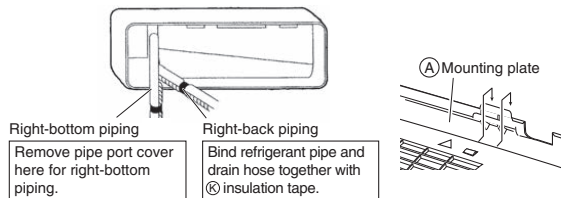

How to remove the pipe port cover

- 1) Cut off the pipe port cover (on the bottom of the front grille) with a coping saw. Apply the blade of the coping saw to the notch, and cut off the pipe port cover along the uneven inner surface.
- 2) After cutting off the pipe port cover, perform filing. Remove the burrs along the cut section using a half round needle file.

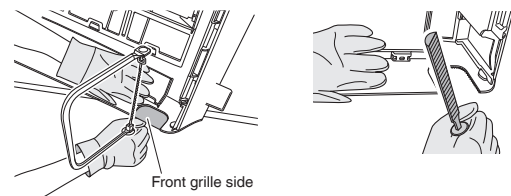

NOTE

- Be careful not to let chips enter the driving section of the arm.
- Be careful not to put pressure on the lower front panel.

3-2. Left-side, left-back, or left-bottom piping

- 1) Switch around the drain plug and drain hose.

How to switch around the drain plug and drain hose

- 1) Remove the fixing screw and pull out the drain hose.

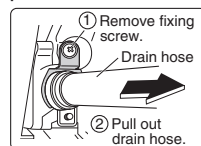

2) Pull out drain plug.

- 3) Switch around the drain hose and drain plug.

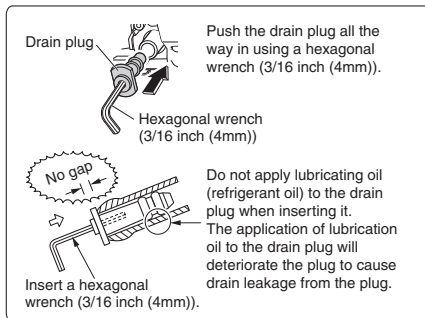

Insert drain hose securely and fix in place with fixing screw.

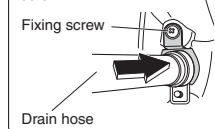

- 2) Attach the drain hose to the underside of the refrigerant pipes with adhesive vinyl tape.
- 3) Shape the refrigerant pipes along the pipe path marking on the (A) mounting plate.

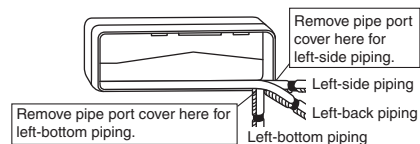

Indoor Unit Installation

How to remove the pipe port cover

- 1) Cut off the pipe port cover with a coping saw.
Apply the blade of the coping saw to the notch, and cut off the pipe port cover along the uneven inner surface.

- **For bottom piping:** On the bottom of the front grille
- **For left side piping:** On the side cover (front grille side and unit side)

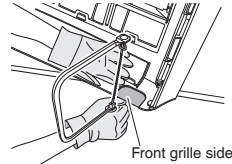

The figure shows the case of left-bottom piping.

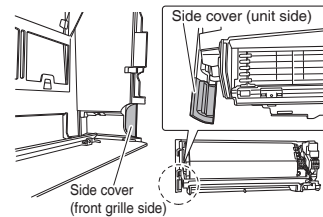

- 2) After cutting off the pipe port cover, perform filing.
Remove the burrs along the cut section using a half round needle file.

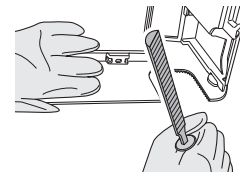

NOTE

- Be careful not to let chips enter the driving section of the arm.
- Be careful not to put pressure on the lower front panel.

- 4) Pass the drain hose and refrigerant pipes through the wall hole, then position the indoor unit on the (A) mounting plate hooks, using the Δ markings at the top of the indoor unit as a guide.

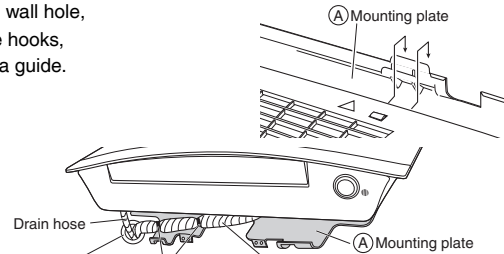

- 5) Connect the refrigerant pipes.
- 6) In case of pulling the drain hose through the back of the indoor unit, wrap the refrigerant pipes and drain hose together with (K) insulation tape as shown in the figure.

Wrap with vinyl tape so that no gap is left and the slit in the thermal insulation pipe is facing upward.

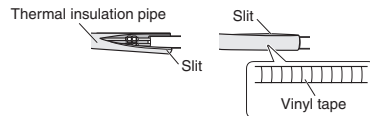

Caulk this hole with putty or caulking material.

Bind with adhesive vinyl tape. If any gap is left or if the refrigerant pipe is bound too tightly, condensation and dripping may result.

Wrap (K) insulation tape from the right end all the way to the left end of the pipe that passes through the back of the indoor unit. Overlap at least half the width of the tape with each turn.

- 7) Press the bottom edge of the indoor unit with both hands until it is firmly caught by the (A) mounting plate hooks. Secure the indoor unit to the (A) mounting plate with the (H) indoor unit fixing screws $M4 \times 1/2''$ ($M4 \times 12\text{mm}$).

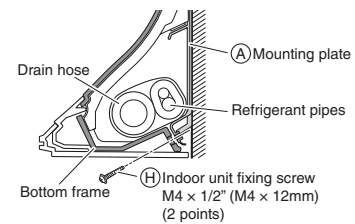

3-3. Wall embedded piping

Follow the instructions given under left-back piping.

- 1) Insert the drain hose to this depth so it won't be pulled out of the drain pipe.

Insert the drain hose to this depth so it won't be pulled out of the drain pipe.

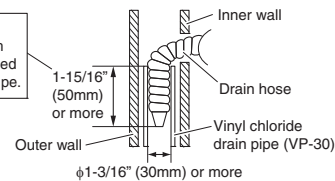

4. Wiring

Refer to the installation manual for the outdoor unit also.

⚠ WARNING

- Do not use tapped wires, extension cords, or starburst connections, as they may cause overheating, electric shock, or fire.
- Do not use locally purchased electrical parts inside the product. (Do not branch the power for the drain pump, etc., from the terminal block.) Doing so may cause electric shock or fire.
- Do not connect the power wire to the indoor unit. Doing so may cause electric shock or fire.

⚠ CAUTION

Recommend stranded cable for interunit wiring. Local code always supersedes recommendation.

- For stranded wires, make sure to use the round crimp-style terminal for connection to the power supply terminal block. Place the round crimp-style terminals on the wires up to the covered part and secure in place.

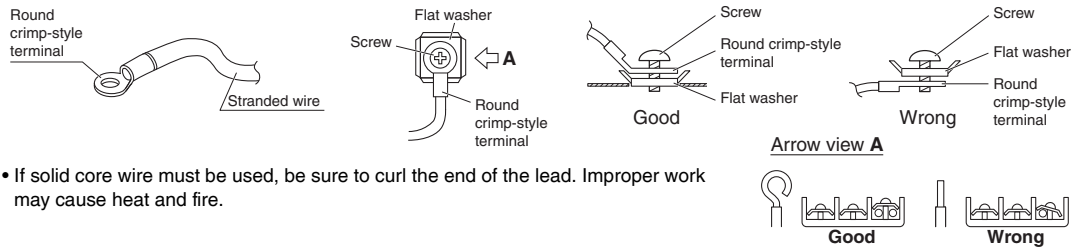

- If solid core wire must be used, be sure to curl the end of the lead. Improper work may cause heat and fire.

With a multi indoor unit, install as described in the installation manual supplied with the multi outdoor unit.

- 1) Remove the upper front panel, then remove the service lid. (Refer to the opening method on page 4.)
- 2) Lift up the unit and place it on the (A) mounting plate hooks.
- 3) Remove the front grille. (Refer to the removal method on page 11.)
- 4) Remove the conduit mounting plate and then secure the conduit to the conduit mounting plate with the lock nut, as shown in the illustration.
- 5) Strip wire ends (3/4 inch (20mm)).
- 6) Match wire colors with terminal numbers on the indoor and outdoor unit's terminal blocks and firmly secure the wires in the corresponding terminals with the screws.
- 7) Connect the ground wire to the corresponding terminals.
- 8) Pull the wires lightly to make sure they are securely connected.

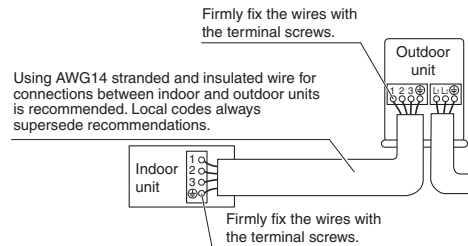
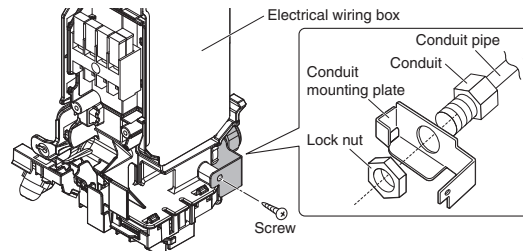
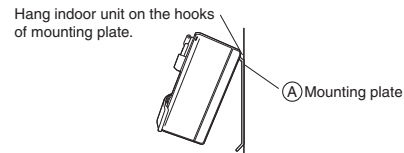
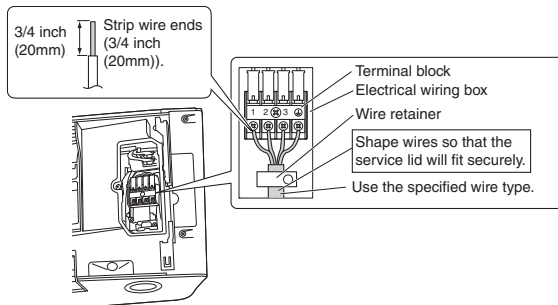

Indoor Unit Installation

- 9) In case of connecting to an adapter system, run the remote controller cable and attach the S21. (Refer to "5. When connecting to an HA system" on page 13.)
- 10) Attach the conduit mounting plate.
- 11) Shape the wires so that the service lid fits securely.
- 12) Attach the front grille. (Refer to removal method on page 11.)
- 13) Attach the service lid and the upper front panel. (Refer to the opening method on page 4.)
- 14) Take care to ensure that all wiring between the indoor unit and the outdoor unit has a consistent connection. Any splices can cause communication errors.

5. Drain piping

- 1) Connect the drain hose, as described on the right.
 - Avoid placing the end of the drain hose in a drainage location that could cause bad odors or corrosive gas to flow backward into the outlet.
 - The drainage water may change color due to bacteria or other organisms. Place in a location where the flow of drainage water will not cause a problem.
 - Minimize the number of bends in the drain hose as much as possible. If bending the drain hose, bend it gently.
- 2) Remove the air filters and transfer some water to the indoor heat exchanger by pouring water into the drain pan.
- 3) Make sure that water flows out of the drain hose.
- 4) If drain hose extension or embedded drain piping is required, use appropriate parts that match the hose front end.

Figure of hose front end

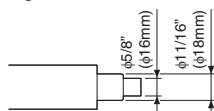

- When drain hose requires extension, obtain an extension hose with an inner diameter of 5/8 inch (16mm). Be sure to thermally insulate the indoor section of the extension hose.
- When connecting a rigid polyvinyl chloride pipe (nominal diameter 1/2 inch (13mm)) directly to the drain hose attached to the indoor unit as with embedded piping work, use any commercially available drain socket (nominal diameter 1/2 inch (13mm)) as a joint.

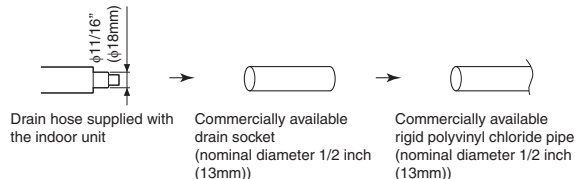
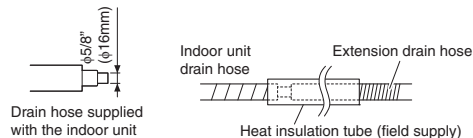
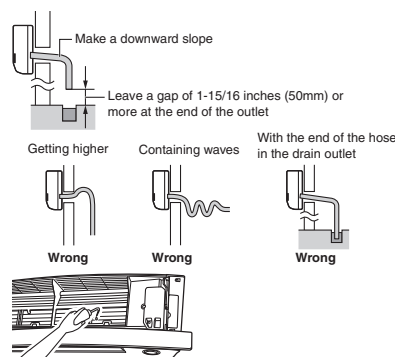

Refrigerant Piping Work

⚠ WARNING

- Do not apply mineral oil on flared part.
- Prevent mineral oil from getting into the system as this would reduce the service life of the units.
- Never use piping which has been used for previous installations. Only use parts which are delivered with the unit.
- Never install a dryer to this R410A unit in order to guarantee its service life.
- The drying material may dissolve and damage the system.
- Incomplete flaring may result in refrigerant gas leakage.

With a multi indoor unit, install as described in the installation manual supplied with the multi outdoor unit.

1. Flaring the pipe end

- 1) Cut the pipe end with a pipe cutter.
- 2) Remove burrs with the cut surface facing downward, so that the filings do not enter the pipe.



- 3) Put the flare nut on the pipe.
- 4) Flare the pipe.
- 5) Check that the flaring has been done correctly.

Flaring

Set exactly at the position shown below.

	Flare tool for R32 or R410A		Conventional flare tool	
	Clutch-type	Clutch-type (Rigid-type)	Wing-nut type (Imperial-type)	
A	0-0.020 inch (0-0.5mm)	0.039-0.059 inch (1.0-1.5mm)	0.059-0.079 inch (1.5-2.0mm)	

Check

The flare's inner surface must be flaw-free. The pipe end must be evenly flared in a perfect circle.

When flaring, do not over-tighten and crack. Make sure that the flare nut is fitted.

2. Refrigerant piping

CAUTION

- Use the flare nut fixed to the main unit. (This is to prevent the flare nut from cracking as a result of deterioration over time.)
- To prevent gas leakage, apply refrigeration oil only to the inner surface of the flare. (Use refrigeration oil for R410A.)
- Use a torque wrench when tightening the flare nuts to prevent damage to the flare nuts and gas leakage.

- Align the centers of both flares and tighten the flare nuts 3 or 4 turns by hand, then tighten them fully with a spanner and a torque wrench.

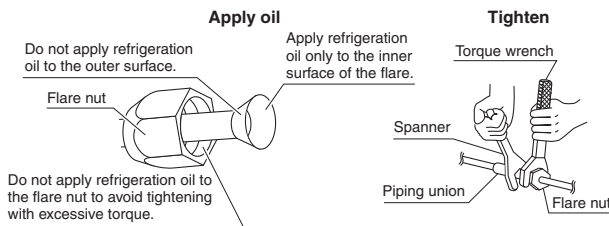

	Piping size	Flare nut tightening torque
Gas side	O.D. 3/8 inch (9.5mm)	24-1/8–29-1/2ft • lbf (32.7-39.9N • m)
	O.D. 1/2 inch (12.7mm)	36-1/2–44-1/2ft • lbf (49.5-60.3N • m)
Liquid side	O.D. 1/4 inch (6.4mm)	10-1/2–12-3/4ft • lbf (14.2-17.2N • m)

2-1. Caution on piping handling

- Protect the open end of the pipe against dust and moisture.
- All pipe bends should be as gentle as possible. Use a pipe bender for bending.

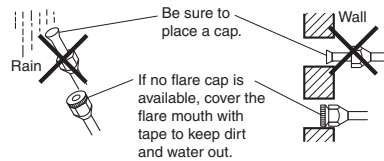

2-2. Selection of copper and heat insulation materials

When using commercial copper pipes and fittings, observe the following:

- Insulation material: Polyethylene foam
Heat transfer rate: 0.041 to 0.052W/mK (0.024 to 0.030Btu/ft²•F (0.035 to 0.045kcal/mh²•C))
Be sure to use insulation that is designed for use with HVAC Systems.
- ACR Copper only.

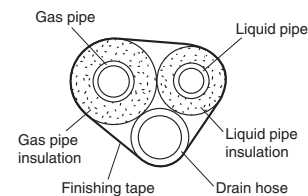

- Be sure to insulate both the gas and liquid piping and observe the insulation dimensions as below.

	Piping size	Minimum bend radius	Piping thickness	Thermal insulation size	Thermal insulation thickness
Gas side	O.D. 3/8 inch (9.5mm)	1-3/16 inch (30mm) or more	0.031 inch (0.8mm) (C1220T-O)	I.D. 15/32-19/32 inch (12-15mm)	13/32 inch (10mm) Min.
	O.D. 1/2 inch (12.7mm)	1-9/16 inch (40mm) or more		I.D. 9/16-5/8 inch (14-16mm)	
Liquid side	O.D. 1/4 inch (6.4mm)	1-3/16 inch (30mm) or more		I.D. 5/16-13/32 inch (8-10mm)	

- Use separate thermal insulation pipes for gas and liquid refrigerant pipes.
- Using finishing tape, bundle and wrap the indoor unit piping and drain hose together so that the drain hose is below the other piping.

Installation Tips

1. Removing and installing the upper front panel

• Removal method

- 1) Open the upper front panel.
- 2) Slide the front panel locks on the back of the front panel upward to release the locks (left and right sides).
- 3) Remove the panel shafts on both sides from the shaft holes, and dismount the upper front panel.

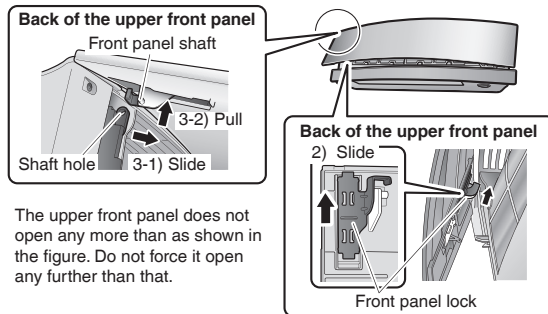

The upper front panel does not open any more than as shown in the figure. Do not force it open any further than that.

⚠ CAUTION

Do not attempt to push closed the front panel with the upper and lower front panels overlapping. Internal parts may break. (See Fig. 5)
If the front panel must be closed by hand for some reason (remote controller not functioning owing to lack of power supply, etc.), follow the instructions affixed to the indoor unit.

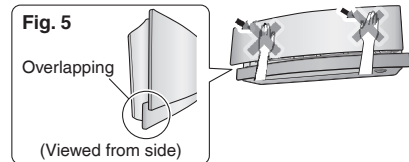
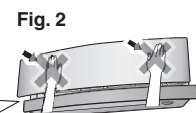
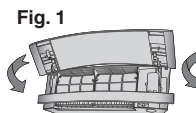

• Installation method

- 1) Slide the front panel locks on the back of the front panel upward to release the locks (left and right sides).
- 2) Insert the panel shafts on both sides of the upper front panel into the shaft holes.
- 3) Slide the front panel locks on each side downward to lock them.
- 4) Close the upper front panel slowly. (See Fig. 1)
- 5) Do not push on the panel to close it. (See Fig. 2)
- 6) Turn on the unit using the remote controller. Wait till the upper and lower front panels are completely open. Then, turn off the unit using the remote controller again. (See Fig. 3)
- 7) Once the both panels close completely, gently push the upper front panel to hook it into position. (See Fig. 4)

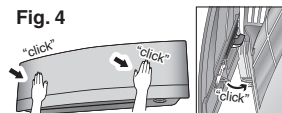

2. Removing and installing the front grille

⚠ CAUTION

Be sure to wear protection gloves.

• Removal method

- 1) Remove the upper front panel and air filters.
- 2) Remove the service lid. (Refer to the opening method on page 4.)
- 3) Disconnect the wire harnesses from the wire clamp, and remove the wire harnesses from the connectors.
- 4) Push the lower front panel up until it stops.
- 5) Dismount the flap (large).
- 6) Open the 2 screw covers, and remove 4 screws from the front grille.
(The screw covers are not factory-mounted.)

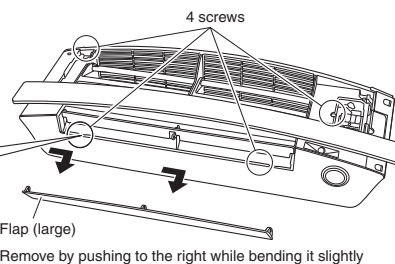
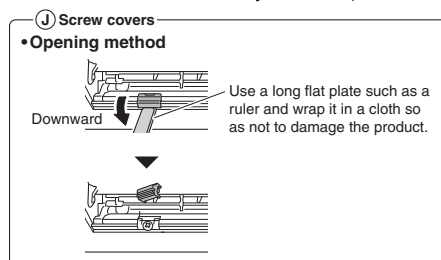
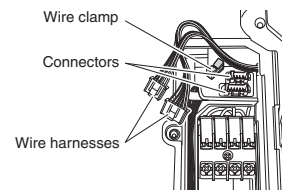

- 7) Wear protection gloves and insert both hands under the front grille as shown in the figure.
- 8) Remove the front grille from the 3 upper hooks by pushing up the top side of the front grille, pull the front grille toward you by holding both ends of the front grille, and dismount the front grille.
 - If the grille is hard to remove, insert a long flat plate* through the gap in the side cover as shown in the figure, and turn the plate inwards to disengage the hooks (3 hooks each on the right and left sides) so that you can remove the grille easily.
 - * Such as a ruler wrapped in a cloth

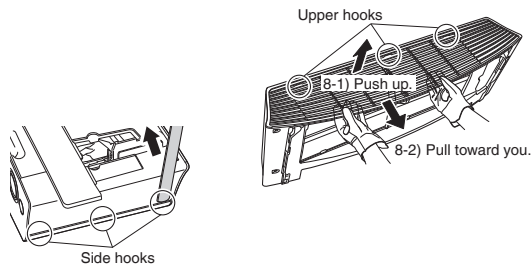

• Installation method

- 1) Install the front grille and firmly engage the upper hooks (3 locations), right and left sides hooks (each 3 locations).
- 2) Install 4 screws of the front grille, and close the 2 screw covers.
- 3) Mount the flap (large).
- 4) Lower the lower front panel to the original position.
- 5) Attach the wire harnesses to the 2 connectors and secure the wire harnesses with the wire clamp.
- 6) Install the air filters and then mount the upper front panel.

3. How to set the different addresses

When 2 indoor units are installed in one room, the 2 wireless remote controllers can be set for different addresses. Change the address setting of one of the two units. When cutting the jumper be careful not to damage any of the surrounding parts.

- 1) Remove the upper front panel and front grille. (Refer to the removal method on page 11.)
- 2) Cut the address jumper (JA) on the printed circuit board.
- 3) Cut the address jumper (J4) in the remote controller.
 - Be careful not to cut jumper (J8).

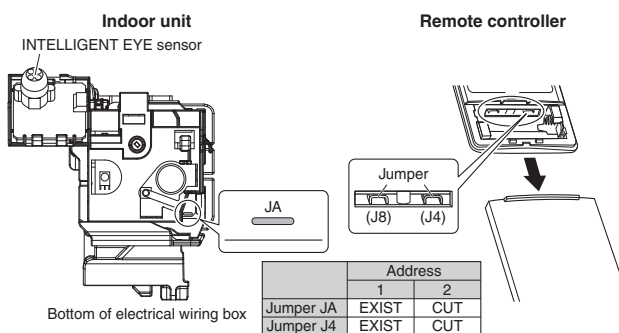

4. When connecting a wireless LAN connecting adapter

• Connection method

- 1) Remove the upper front panel. (Refer to the removal method on page 11.)
- 2) Open the cover, grab the connecting cord with your fingers and pull it out.
- 3) Remove the binding band and pull the insulation tube off the connecting cord.
- 4) Connect the wireless LAN connecting adapter. (For details on connection procedures, refer to the installation manual for the wireless LAN connecting adapter.)
- 5) Place the adapter case into the indoor unit and close the cover.
- 6) Install the upper front panel. (Refer to the installation method on page 11.)

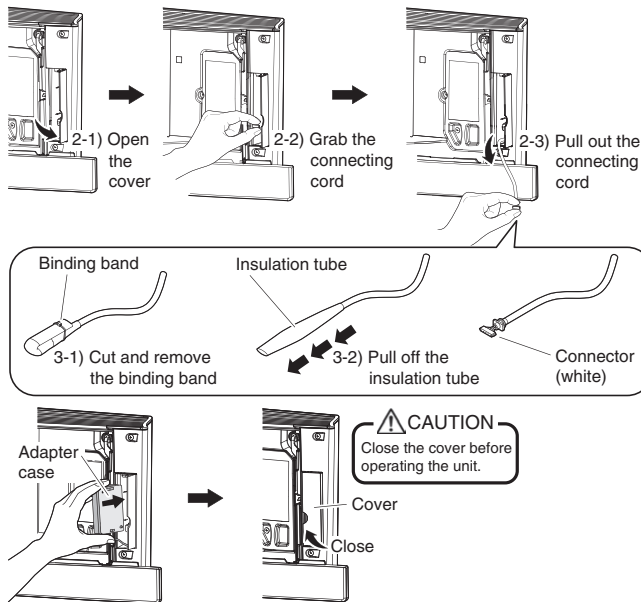

CAUTION
Close the cover before operating the unit.

Installation Tips

5. When connecting to an HA system (wired remote controller, central remote controller etc.)

• Removal methods for metal plate electrical wiring box covers

- 1) Remove the upper front panel and front grille. (Refer to the removal method on page 11.)
- 2) Remove the electrical wiring box. (1 screw)
- 3) Remove the 4 tabs and dismount the metal plate electrical wiring box cover (A).
- 4) Pull down the hook on the metal plate electrical wiring box cover (B), and remove a single tab.
- 5) Remove the 2 tabs on the top part and dismount the metal plate electrical wiring box cover (B).

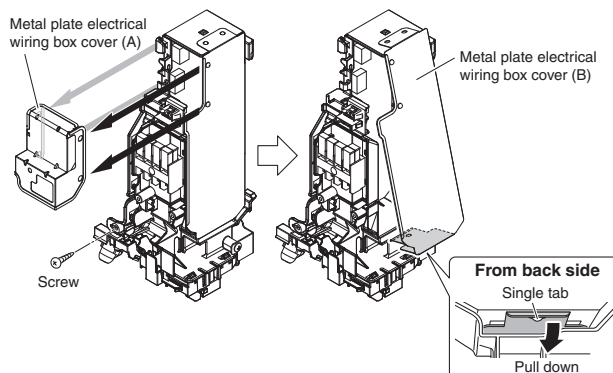

• Attachment methods of connection cord

- 1) Remove the factory-mounted connector from S21.
- 2) Tie the harnesses in a bundle as shown in the figure so that the removed connector does not interfere with the printed circuit board.

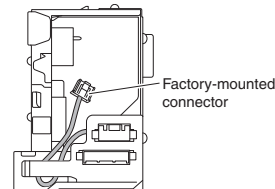

- 3) Attach the connection cord to the S21 connector and pull the harness out through the notched part in the figure.

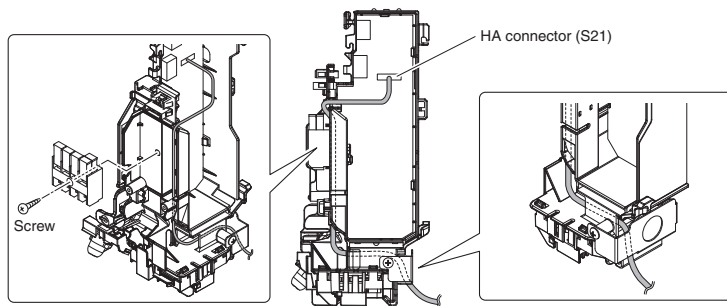

• Attachment methods for metal plate electrical wiring box covers



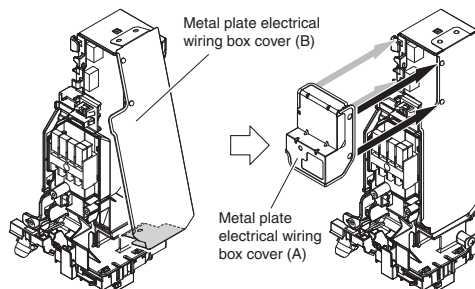



- 1) Hook the top part of the metal plate electrical wiring box cover (B) on the 2 tabs.
- 2) Press in the hook on the bottom to catch a single tab, and mount the metal plate electrical wiring box cover (B).
- 3) Insert the connector into the hole, and hook and mount the metal plate electrical wiring box cover (A) onto the 4 tabs.
- 4) Install the electrical wiring box. (1 screw)
- 5) Install the upper front panel and front grille. (Refer to the installation method on page 11.)





Trial Operation and Testing

1. Trial operation and testing

- Trial operation should be carried out in either COOL or HEAT operation.
- 1-1. Measure the supply voltage and make sure that it is within the specified range.**
- 1-2. In COOL operation, select the lowest programmable temperature; in HEAT operation, select the highest programmable temperature.**
- 1-3. Carry out the trial operation following the instructions in the operation manual to ensure that all functions and parts, such as the movement of the louvers, are working properly.**
 - To protect the air conditioner, restart operation is disabled for 3 minutes after the system has been turned off.
- 1-4. After trial operation is complete, set the temperature to a normal level (78°F to 82°F (26°C to 28°C) in COOL operation, 68°F to 75°F (20°C to 24°C) in HEAT operation).**
- When operating the air conditioner in COOL operation in winter, or HEAT operation in summer, set it to the trial operation mode using the following method.

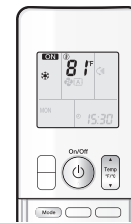
- 1) Press , , and  at the same time.
- 2) Press , select "7", and press  for confirmation.
- 3) Press  to turn on the system.



- Trial operation will stop automatically after about 30 minutes. To stop the operation, press .
- Some of the functions cannot be used in the trial operation mode.
- The air conditioner draws a small amount of power in its standby mode. If the system is not to be used for some time after installation, shut off the circuit breaker to eliminate unnecessary power consumption.
- If the circuit breaker trips to shut off the power to the air conditioner, the system will restore the original operation mode when the circuit breaker is opened again.

2. Test items

Test items	Symptom	Check
Indoor and outdoor units are installed securely.	Fall, vibration, noise	
No refrigerant gas leaks.	Incomplete cooling/heating function	
Refrigerant gas and liquid pipes and indoor drain hose extension are thermally insulated.	Water leakage	
Draining line is properly installed.	Water leakage	
System is properly grounded.	Electrical leakage	
Only specified wires are used for all wiring, and all wires are connected correctly.	No operation or burn damage	
Indoor or outdoor unit's air inlet or air outlet are unobstructed.	Incomplete cooling/heating function	
Stop valves are opened.	Incomplete cooling/heating function	
Indoor unit properly receives remote controller commands.	No operation	
 will be displayed when the MODE button is pressed.	No heating	
Pipes and wires are connected to the corresponding terminal blocks/ connection ports for the connected unit.	No cooling/heating	

1.4 FVXS

Contents

Safety Considerations 1

Accessories 3

Choosing an Installation Site 3

 1. Indoor unit 3

 2. Wireless remote controller..... 3

Indoor Unit Installation Diagram 4

Indoor Unit Installation 5

 1. Refrigerant piping 5

 2. Drilling a wall hole and installing wall embedded pipe..... 7

 3. Drain piping 7

 4. Installing indoor unit 8

 4-1. Preparation 8

 4-2. Installation 9

 5. Flaring the pipe end..... 12

 6. Refrigerant piping 12

 6-1. Caution on piping handling 13

 6-2. Selection of copper and heat insulation materials 13

 7. Checking for gas leakage 13

 8. Attaching the connection pipe 13

 9. Wiring 14

 10. When connecting to an HA system 16

 11. How to set the different addresses 17

Trial Operation and Testing 18

 1. Trial operation and testing 18

 2. Test items 18

The pictures in this document are for illustrative purposes only.

Safety Considerations





Refer also to the General Safety Considerations in the separate booklet.



Read the precautions in this manual carefully before operating the unit.

Read these **Safety Considerations for Installation** carefully before installing an air conditioner or heat pump. After completing the installation, make sure that the unit operates properly during the startup operation. Instruct the user on how to operate and maintain the unit. Inform users that they should store this installation manual with the operation manual for future reference. Always use a licensed installer or contractor to install this product. Improper installation can result in water or refrigerant leakage, electric shock, fire, or explosion.

Meanings of **DANGER**, **WARNING**, **CAUTION**, and **NOTE** Symbols:

-  **DANGER** Indicates an imminently hazardous situation which, if not avoided, will result in death or serious injury.
-  **WARNING** Indicates a potentially hazardous situation which, if not avoided, could result in death or serious injury.
-  **CAUTION** Indicates a potentially hazardous situation which, if not avoided, may result in minor or moderate injury. It may also be used to alert against unsafe practices.
-  **NOTE** Indicates situations that may result in equipment or property damage accidents only.

 **DANGER** _____

- Refrigerant gas is heavier than air and replaces oxygen. A massive leak can lead to oxygen depletion, especially in basements, and an asphyxiation hazard could occur leading to serious injury or death.
- Do not ground units to water pipes, gas pipes, telephone wires, or lightning rods as incomplete grounding can cause a severe shock hazard resulting in severe injury or death. Additionally, grounding to gas pipes could cause a gas leak and potential explosion causing severe injury or death.

- If refrigerant gas leaks during installation, ventilate the area immediately. Refrigerant gas may produce toxic gas if it comes into contact with fire. Exposure to this gas could cause severe injury or death.
- After completing the installation work, check that the refrigerant gas does not leak throughout the system.
- Do not install unit in an area where flammable materials are present due to risk of explosions that can cause serious injury or death.
- Safely dispose all packing and transportation materials in accordance with federal/state/local laws or ordinances. Packing materials such as nails and other metal or wood parts, including plastic packing materials used for transportation may cause injuries or death by suffocation.

 **WARNING** _____

- Only qualified personnel licensed or certified in their jurisdiction must carry out the installation work. Installation must be done in accordance with this installation manual. Improper installation may result in water leakage, electric shock, or fire.
- When installing the unit in a small room, take measures to keep the refrigerant concentration from exceeding allowable safety limits. Excessive refrigerant leaks, in the event of an accident in a closed ambient space, can lead to oxygen deficiency.
- Use only specified accessories and parts for installation work. Failure to use specified parts may result in water leakage, electric shock, fire, or the unit falling.
- Install the air conditioner or heat pump on a foundation strong enough that it can withstand the weight of the unit. A foundation of insufficient strength may result in the unit falling and causing injuries.
- Take into account strong winds, typhoons, or earthquakes when installing. Improper installation may result in the unit falling and causing accidents.
- Make sure that a separate power supply circuit is provided for this unit and that all electrical work is carried out by qualified personnel licensed or certified in their jurisdiction according to local, state, and national regulations. An insufficient power supply capacity or improper electrical construction may lead to electric shock or fire.
- Make sure that all wiring is secured, that specified wires are used, and that no external forces act on the terminal connections or wires. Improper connections or installation may result in fire.

- When wiring, position the wires so that the electrical wiring box cover can be securely fastened. Improper positioning of the electrical wiring box cover may result in electric shock, fire, or the terminals overheating.
- Before touching electrical parts, turn off the unit.
- The circuit must be protected with safety devices in accordance with local and national codes, i.e. a circuit breaker.
- Securely fasten the outdoor unit terminal cover (panel). If the terminal cover/panel is not installed properly, dust or water may enter the outdoor unit causing fire or electric shock.
- When installing or relocating the system, keep the refrigerant circuit free from substances other than the specified refrigerant (R410A) such as air. Any presence of air or other foreign substance in the refrigerant circuit can cause an abnormal pressure rise or rupture, resulting in equipment damage and even injury.
- Do not change the setting of the protection devices. If the pressure switch, thermal switch, or other protection device is shorted and operated forcibly, or parts other than those specified by Daikin are used, fire or explosion may occur.
- Do not use means to accelerate the defrosting process (if possible) or to clean, other than those recommended by the manufacturer.
- The appliance must be stored in a room without continuously operating ignition sources (for example: open flames, an operating gas appliance or an operating electric heater).
- Do not pierce or burn.
- Be aware that refrigerants may not contain an odor.
- Comply with national gas regulations.

CAUTION

- Do not touch the switch with wet fingers. Touching a switch with wet fingers can cause electric shock.
- Do not allow children to play on or around the unit to prevent injury.
- Wear adequate personal protective equipment (protective gloves, safety glasses,...) when installing, maintaining or servicing the system.
- The heat exchanger fins are sharp enough to cut. To avoid injury, wear gloves or cover the fins while working around them.
- Do not touch the refrigerant pipes during and immediately after operation as the refrigerant pipes may be hot or cold, depending on the condition of the refrigerant flowing through the refrigerant piping, compressor, and other refrigerant cycle parts. Your hands may suffer burns or frostbite if you touch the refrigerant pipes. To avoid injury, give the pipes time to return to normal temperature or, if you must touch them, be sure to wear proper gloves.
- Install drain piping to ensure proper drainage. Improper drain piping may result in water leakage and property damage.
- Insulate piping to prevent condensation.
- Be careful when transporting the product.
- Do not turn off the power immediately after stopping operation. Always wait for at least 5 minutes before turning off the power. Otherwise, water leakage may occur.
- Do not use a charging cylinder. Using a charging cylinder may cause the refrigerant to deteriorate.
- Refrigerant R410A in the system must be kept clean, dry, and tight.
 - (a) Clean and Dry -- Foreign materials (including mineral oils such as SUNISO oil or moisture) should be prevented from getting into the system.

- (b) Tight -- R410A does not contain any chlorine, does not destroy the ozone layer, and does not reduce the earth's protection against harmful ultraviolet radiation. R410A can contribute to the greenhouse effect if it is released. Therefore take proper measures to check for the tightness of the refrigerant piping installation. Read the chapter *Refrigerant Piping Work* and follow the procedures.
- Since R410A is a blend, the required additional refrigerant must be charged in its liquid state. If the refrigerant is charged in a state of gas, its composition can change and the system will not work properly.
- The indoor unit is for R410A. See the catalog for outdoor models that can be connected. Normal operation is not possible when connected to non-compatible outdoor units.
- Remote controller (wireless kit) transmitting distance can be shorter than expected in rooms with electronic fluorescent lamps (inverter or rapid start types). Install the indoor unit far away from fluorescent lamps as much as possible.
- Indoor units are for indoor installation only. Outdoor units can be installed either outdoors or indoors.
- Do not install the air conditioner or heat pump in the following locations:
 - (a) Where a mineral oil mist or oil spray or vapor is produced, for example, in a kitchen. Plastic parts may deteriorate and fall off or result in water leakage.
 - (b) Where corrosive gas, such as sulfurous acid gas, is produced. Corroding copper pipes or soldered parts may result in refrigerant leakage.
 - (c) Near machinery emitting electromagnetic waves. Electromagnetic waves may disturb the operation of the control system and cause the unit to malfunction.
 - (d) Where flammable gas may leak, where there is carbon fiber, or ignitable dust suspension in the air, or where volatile flammables such as thinner or gasoline are handled. Operating the unit in such conditions can cause a fire.
- Take adequate measures to prevent the outdoor unit from being used as a shelter by small animals. Small animals making contact with electrical parts can cause malfunctions, smoke, or fire. Instruct the user to keep the area around the unit clean.
- Servicing shall be performed only as recommended by the manufacturer and licensed or certified in their jurisdiction.









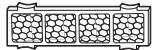

NOTE

- The indoor unit should be positioned where the unit and inter-unit wires (outdoor to indoor) are at least 3.3ft (1m) away from any televisions or radios. (The unit may cause interference with the picture or sound.) Depending on the radio waves, a distance of 3.3ft (1m) may not be sufficient to eliminate the noise.
- Dismantling the unit, treatment of the refrigerant, oil and additional parts must be done in accordance with the relevant local, state, and national regulations.
- Only use tools for R410A, such as a gauge manifold, charge hose, gas leak detector, reverse flow check valve, refrigerant charge base, vacuum gauge, or refrigerant recovery equipment.
- If the conventional refrigerant and refrigerator oil are mixed in R410A, the refrigerant may deteriorate.
- This air conditioner or heat pump is an appliance that should not be accessible to the general public.
- As maximum allowable pressure is 604psi (4.17MPa), the wall thickness of field-installed pipes should be selected in accordance with the relevant local, state, and national regulations.

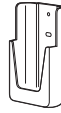
FTN005-U

2

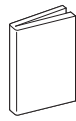
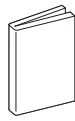
Accessories

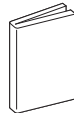
(A) Mounting plate 	1	(B) Titanium apatite deodorizing filter 	2	(C) Drain hose 	1
(D) Insulation tape 	2	(E) Wireless remote controller 	1	(F) Remote controller holder 	1
(G) Remote controller holder fixing screw M3 × 13/16" (M3 × 20mm) 	2	(H) Indoor unit fixing screw M4 × 1" (M4 × 25mm) 	9	(J) Dry battery AAA. LR03 (alkaline) 	2
(K) Operation manual 	1	(L) Installation manual 	1	(M) Warranty 	1
(N) General safety considerations 	1				

Choosing an Installation Site

- Before choosing the installation site, obtain user approval.

1. Indoor unit

The indoor unit should be positioned in a place where:

- 1) the restrictions on the installation requirements specified in "Indoor Unit Installation Diagram" on page 4 are met,
- 2) both the air inlet and air outlet are unobstructed,
- 3) the unit is not exposed to direct sunlight,
- 4) Install so that drainage occurs easily,
- 5) the unit is away from sources of heat or steam,
- 6) there is no source of machine oil vapor (this may shorten the indoor unit service life),
- 7) cool/warm air is circulated throughout the room,
- 8) the unit is away from electronic ignition type fluorescent lamps (inverter or rapid start type) as they may affect the remote controller range,
- 9) no laundry equipment is nearby.

2. Wireless remote controller

Turn on all the fluorescent lamps in the room, if any, and find a location where the remote controller signals are properly received by the indoor unit (within 23ft (7m)).

Indoor Unit Installation Diagram

- The indoor unit may be mounted in any of the 3 styles shown here.

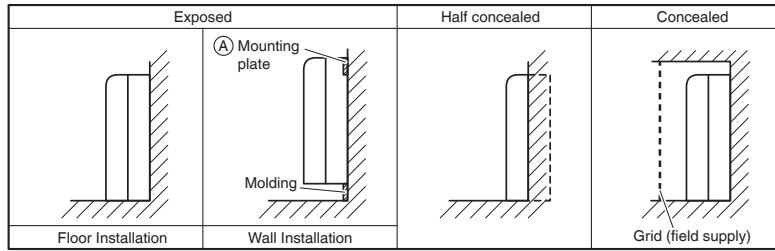

- Recommended mounting plate retention spots and dimensions.

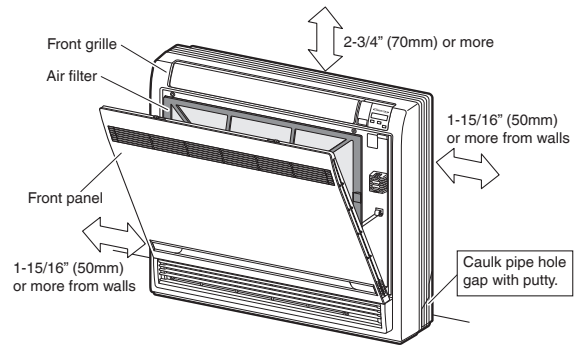
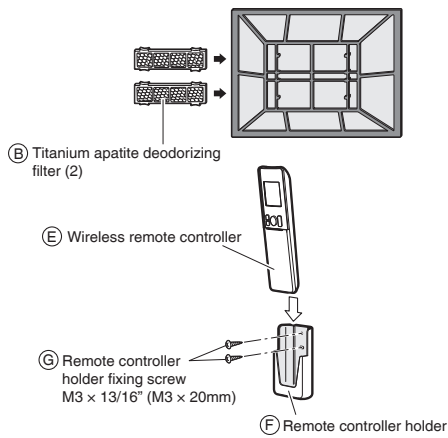
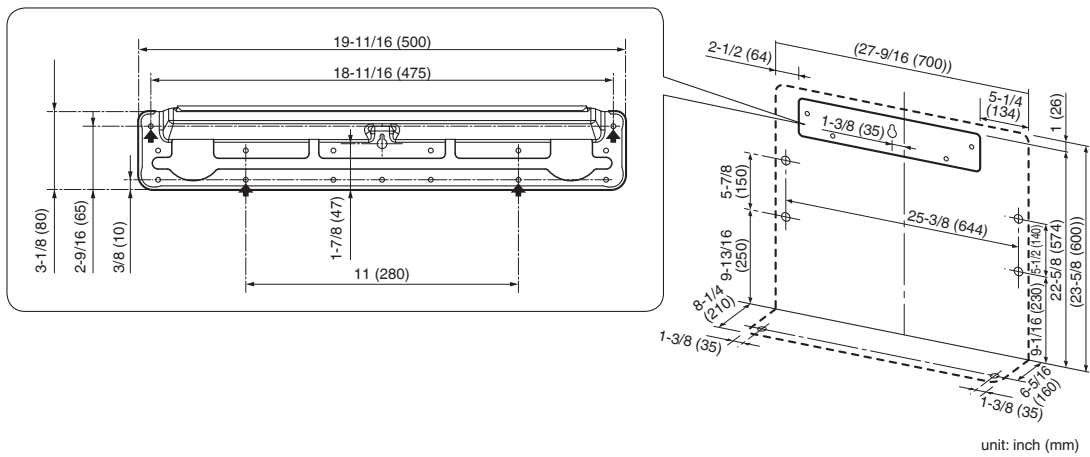

Indoor Unit Installation

1. Refrigerant piping

- 1) Drill a hole ($\phi 2-9/16$ inch (65mm) in diameter) in the spot indicated by the  symbol in the illustration as below.
- 2) The location of the hole is different depending on which side of the pipe is taken out.
- 3) For piping, refer to "6. Refrigerant piping" on page12.
- 4) Allow space around the pipe for a easier indoor unit pipe connection.

[Bottom piping]

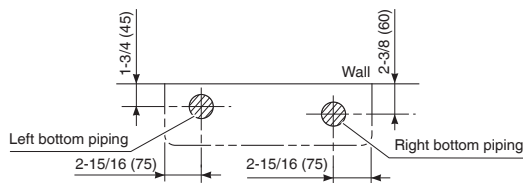

Exposed installation

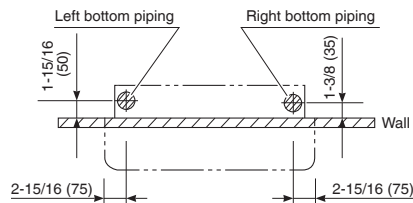

Half concealed installation

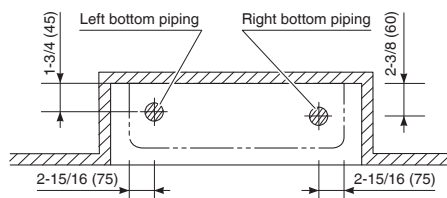

Concealed installation

unit: inch (mm)

[Left/Right -side piping]

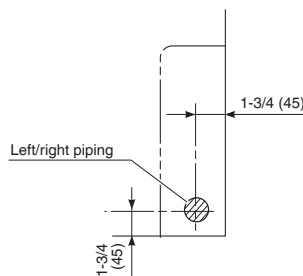

Exposed installation

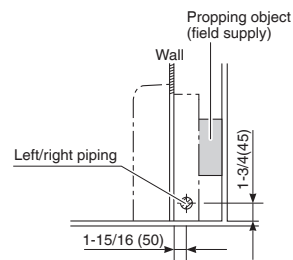

Half concealed installation

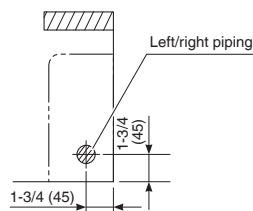

Concealed installation

unit: inch (mm)

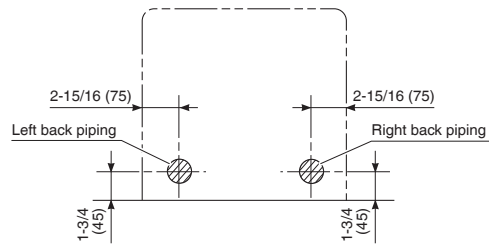
[Back piping]

unit: inch (mm)

About the outdoor unit refrigerant pipe

- In order to connect the pipe, the outdoor unit refrigerant pipe must have a length of at least 13-3/4 inch (350mm) measured from the wall.

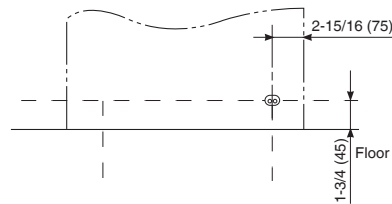
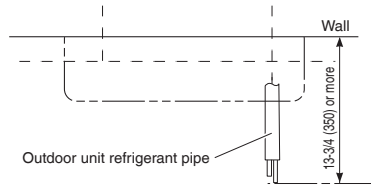

unit: inch (mm)

⚠ CAUTION**Minimum allowable length**

- The suggested shortest pipe length is 8.2ft (2.5m), in order to avoid noise from the outdoor unit and vibration. (Mechanical noise and vibration may occur depending on how the unit is installed and the environment in which it is used.)
- Refer to the installation manual for the outdoor unit for the maximum pipe length.
- For multi-connections, refer to the installation manual for the multi outdoor unit.

Indoor Unit Installation

2. Drilling a wall hole and installing wall embedded pipe

⚠ WARNING

For metal frame or metal board walls, be sure to use a wall embedded pipe and wall hole cover in the feed-through hole to prevent possible heat, electric shock, or fire.

- Be sure to caulk the gaps around the pipes with caulking material. (to prevent condensation caused by intrusion of air from outside or within the wall)
- 1) Drill a feed-through hole with a $\phi 2\text{-}9/16$ inch (65mm) diameter through the wall at a downward angle toward the outside. (to prevent water leakage)
 - 2) Insert a wall embedded pipe into the hole.
 - 3) Insert a wall hole cover into wall pipe.
 - 4) After completing refrigerant piping, wiring, and drain piping, caulk the pipe hole gap with putty.

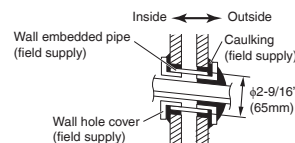

Even if a wall hole cover is not used, caulk both the outdoor and indoor sides with putty.

3. Drain piping

- 1) Perform drain piping work as outlined in the figure. (See Fig. 1)
 - Insert the © drain hose into the socket of the drain pan. (See Fig. 2) Fully insert the drain hose until it adheres to a seal of the socket.
 - The drain hose (outer diameter $\phi 1\text{-}1/16$ inch ($\phi 18\text{mm}$) at connecting end, 8-11/16 inch (220mm) long) is supplied with the indoor unit.
 - Use commercial rigid polyvinyl chloride pipe (general VP 20 pipe, outer diameter 1 inch (26mm), inner diameter 13/16 inch (20mm)) for the drain pipe.

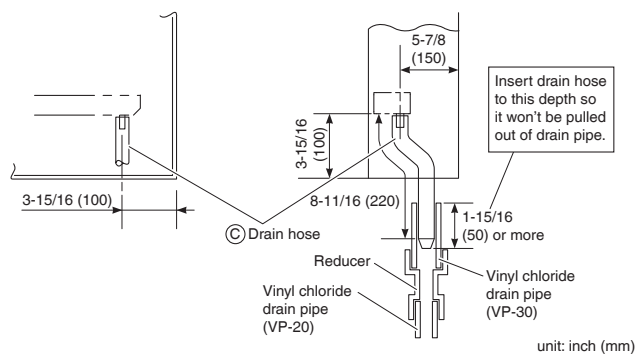

Fig. 1

- The drain pipe should be **inclined downward** so that water will flow smoothly without any accumulation. (Should not be trap.)
- Avoid placing the end of the drain hose in a drainage location that could cause bad odours or corrosive gas to flow backward into the outlet.
- The drainage water may change colour due to bacteria or other organisms. Place in a location where the flow of drainage water will not cause a problem.
- Minimize the number of bends in the drain hose as much as possible. If bending the drain hose, bend it gently.

- 2) **Insulate the indoor drain pipe with 3/8 inch (10mm) or more of insulation material to prevent condensation.**
- 3) Remove the air filters and pour some water into the drain pan to check the water flows smoothly.

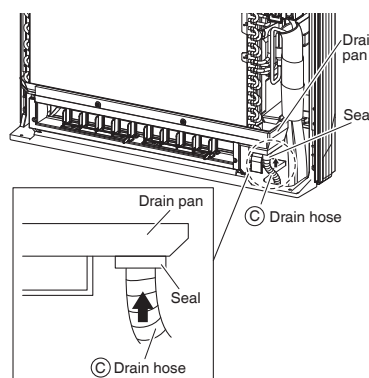
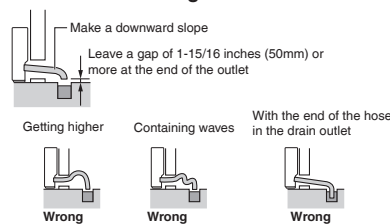

Fig. 2



⚠ CAUTION

Use polyvinyl chloride adhesive agent for gluing. Failure to do so may cause water leakage.

4. Installing indoor unit

4-1. Preparation

- Remove the front panel.
 - 1) Slide until the 2 stoppers click inside.
 - 2) Open the front panel forward and remove the string.
 - 3) Remove the front panel.

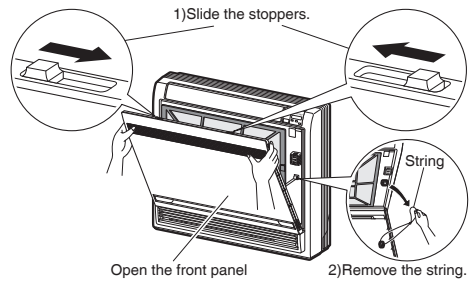

- Remove the front grille.
 - 1) Remove the 4 screws.
 - 2) Pull the front grille and remove the 3 tabs.

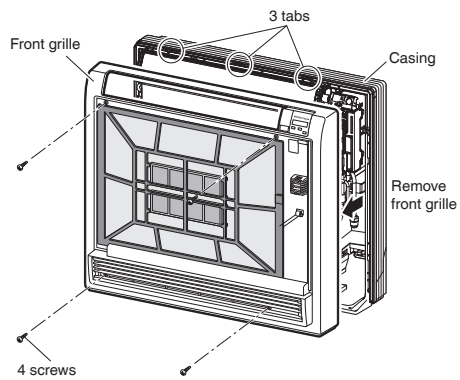

- Remove the upper and the side casings.
 - 1) Remove the 7 screws.
 - 2) Slide and remove the upper casing (2 tabs).
 - 3) Slide and remove the left and right casings (2 tabs on each side).

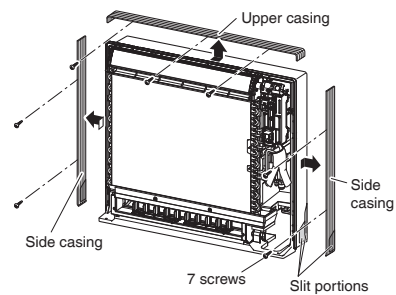

- During installation, if needed, cut the slit portions using nippers as shown in the illustration below.

[For moldings]

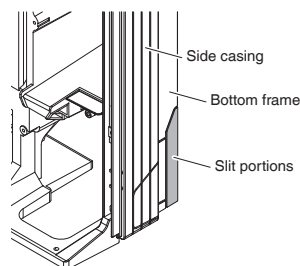

[For side piping]

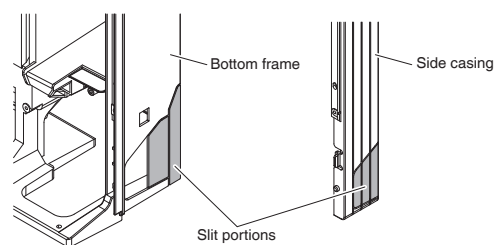

Indoor Unit Installation

4-2. Installation

Exposed installation

1) Secure the indoor unit

[Floor Installation]

- Secure the indoor unit using 6 screws. (2 screws for floor and 4 screws for rear wall)

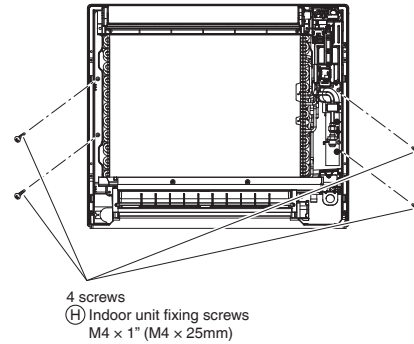
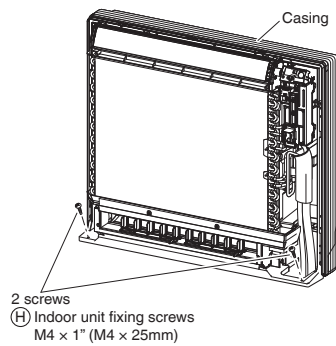

[Wall Installation]

- Secure the (A) mounting plate using 5 screws.
- Secure the indoor unit using 4 screws for rear wall.

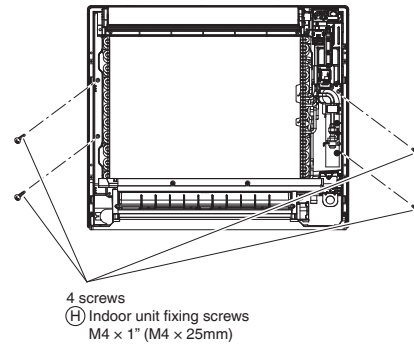
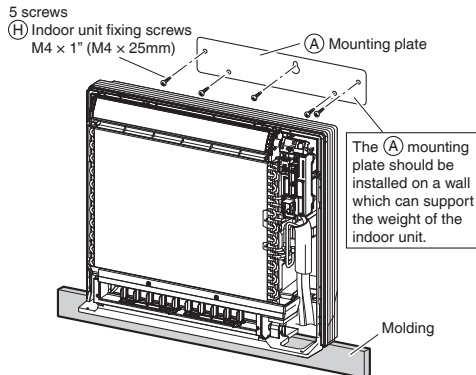

- Once refrigerant piping and drain piping connections are complete, fill in the gap of the through hole with putty. **Any gaps will result in the accumulation of condensation on the refrigerant pipe and drain pipe, as well as allowing the intrusion of insects and dirt.**
- Attach the left, right and upper casings in their original positions using 7 screws.
- Attach the front grill in its original position using 4 screws.
- Attach the front panel in its original position.
 - Attach the string to the right, inner-side of the front grille.
 - Close the front panel and slide until the 2 stoppers click outside.

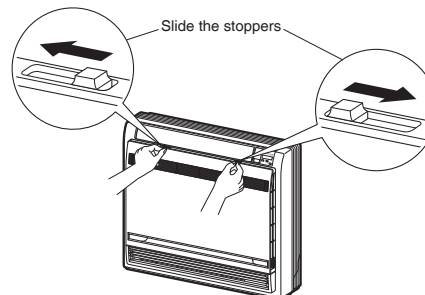

Half concealed installation

1) The size of a wall opening space shown in the illustration on the right.

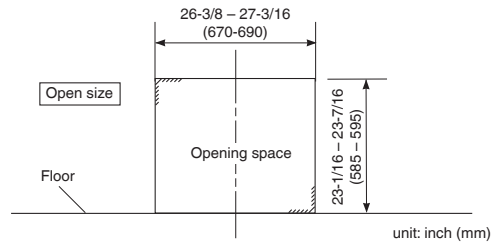

2) The rear of the unit can be fixed with screws at the points shown in the illustration as below. Be sure to install the propping object in accordance with the depth of the inner wall.

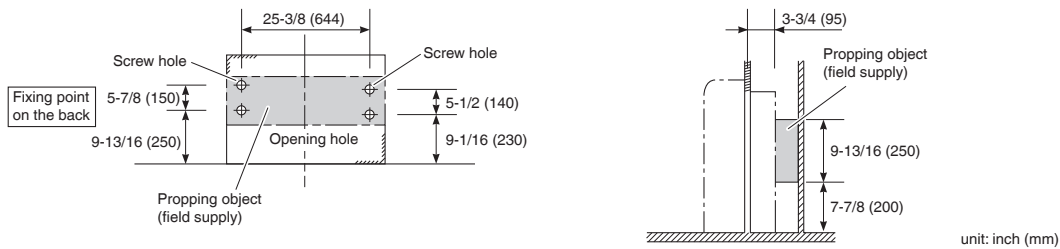

CAUTION

The propping object for installing the main unit must be used, or there will be a gap between the unit and the wall.

3) Secure the indoor unit using 6 screws. (2 screws for floor and 4 screws for rear wall)

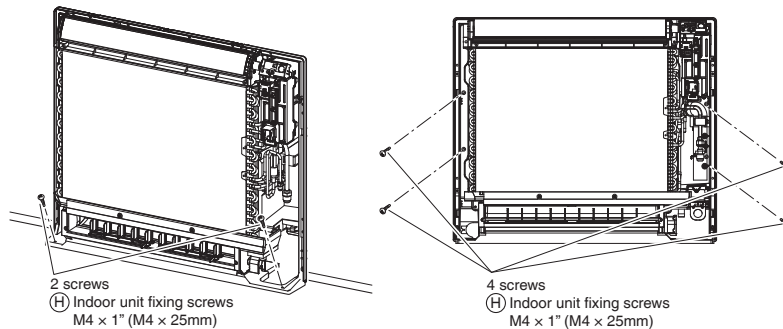

4) Once refrigerant piping and drain piping connections are complete, fill in the gap of the through hole with putty. **Any gaps will result in the accumulation of condensation on the refrigerant pipe and drain pipe, as well as allowing the intrusion of insects and dirt.**

5) Attach the left, right and upper casings in their original positions using 7 screws.

6) Attach the front grill in its original position using 4 screws.

7) Attach the front panel in its original position.

- Attach the string to the right, inner-side of the front grille.
- Close the front panel and slide until the 2 stoppers click outside.

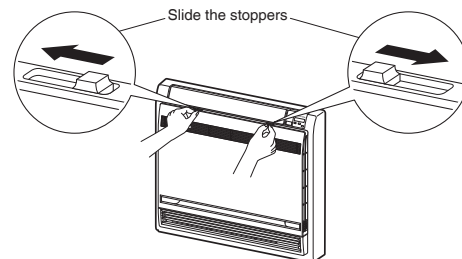

CAUTION

- Use drain pan edge for horizontal projection of the indoor unit.
- Install the indoor unit flush against wall.

Indoor Unit Installation

Concealed installation

• Install the unit according to the instructions below. Failure to do so may cause lead to both cooling and heating failure and the condensation inside the house.

- 1) Allow enough space between the main unit and ceiling not to obstruct the flow of cool/warm air.
- 2) Place a partition plate between outlet and inlet sections.
- 3) Place a partition plate on the right side.
- 4) Change the upward airflow dipswitch (SW2-4) to ON to limit the upward airflow. (Factory default: OFF)
 - Remove the front grille.
 - Switch the dipswitch (SW2-4) on the PCB in the electrical equipment box to ON.

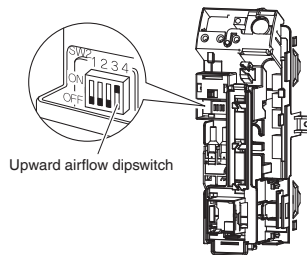

CAUTION
 Be sure to turn on the upward airflow switch. Failure to do so may cause incomplete cooling/heating and formation of condensation inside the house.

- 5) Use a movable lattice at the air outlet to allow the adjustment of cool/warm airflow direction.
- 6) Lattice size should be 70% or more of open rate.

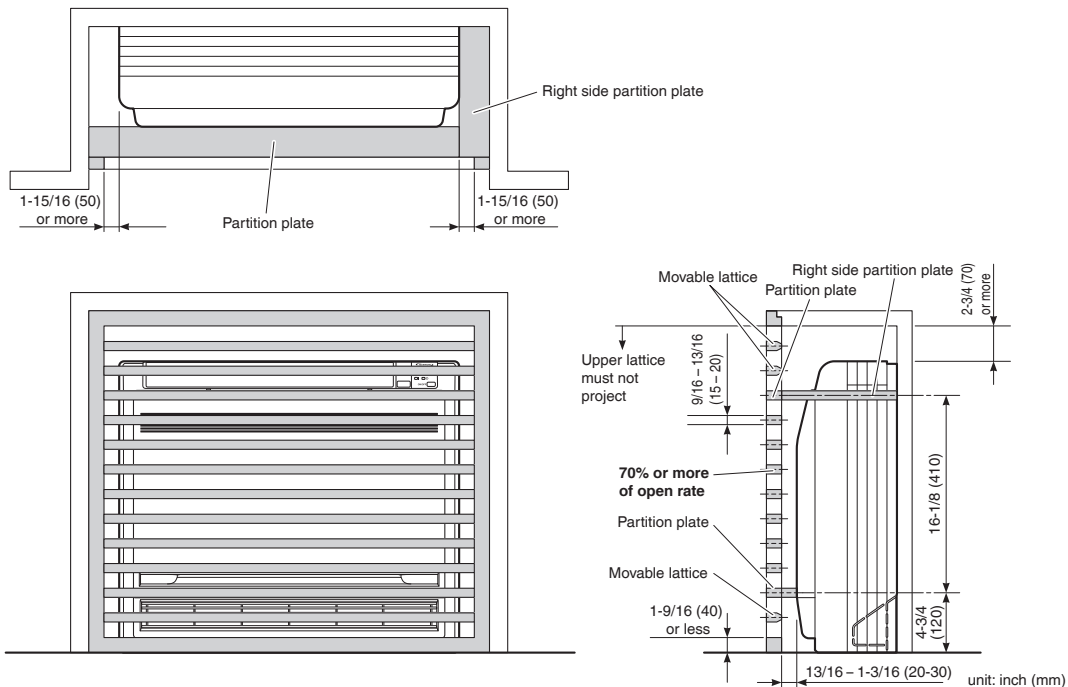

• For the installation process refer to “Exposed installation” on page 9.

⚠ WARNING

- Do not apply mineral oil to the flare.
- Prevent mineral oil from getting into the system as this would reduce the service life of the units.
- Never use piping which has been used for previous installations. Only use parts which are delivered with this unit.
- Never install a dryer to this R410A unit in order to guarantee its service life.
- The drying material may dissolve and damage the system.
- Improper flaring may result in refrigerant gas leakage.

5. Flaring the pipe end

- 1) Cut the pipe end with a pipe cutter.
- 2) Remove burrs with the cut surface facing downward, so that the filings do not enter the pipe.



- 3) Put the flare nut on the pipe.
- 4) Flare the pipe.
- 5) Check that the flaring has been done correctly.

Set exactly at the position shown below.

Flaring		Flare tool for R410A		Conventional flare tool	
		Clutch-type	Clutch-type (Rigid-type)	Wing-nut type (Imperial-type)	
A	0-0.020 inch (0-0.5mm)	0.039-0.059 inch (1.0-1.5mm)	0.059-0.079 inch (1.5-2.0mm)		

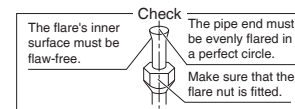

6. Refrigerant piping

⚠ CAUTION

- Use the flare nut fixed to the main unit. (This is to prevent the flare nut from cracking as a result of deterioration over time.)
- To prevent gas leakage, apply refrigeration oil only to the inner surface of the flare. (Use refrigeration oil for R410A.)
- Use a torque wrench when tightening the flare nuts to prevent damage to the flare nuts and gas leakage.

- Align the centers of both flares and tighten the flare nuts 3 or 4 turns by hand, then tighten them fully with a spanner and a torque wrench.

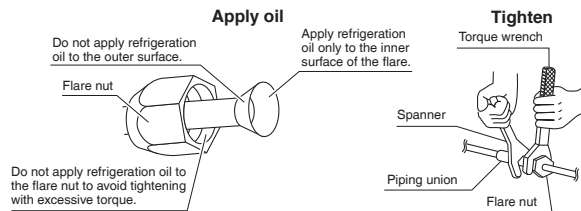

	Piping size	Flare nut tightening torque
Gas side	O.D. 3/8 inch (9.5mm)	24-1/8 – 29-1/2 lbf • ft (32.7-39.9N • m)
	O.D. 1/2 inch (12.7mm)	36-1/2 – 44-1/2 lbf • ft (49.5-60.3N • m)
Liquid side	O.D. 1/4 inch (6.4mm)	10-1/2 – 12-3/4 lbf • ft (14.2-17.2 N • m)

Indoor Unit Installation

6-1. Caution on piping handling

- 1) Protect the open end of the pipe against dust and moisture.
- 2) All pipe bends should be as gentle as possible. Use a pipe bender for bending.

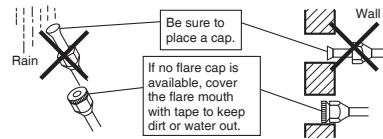

6-2. Selection of copper and heat insulation materials

When using commercial copper pipes and fittings, observe the following:

- Insulation material: Polyethylene foam
Heat transfer rate: 0.041 to 0.052W/mK (0.024 to 0.030Btu/ft²h°F (0.035 to 0.045kcal/mh°C))
Be sure to use insulation that is designed for use with HVAC Systems.
- ACR Copper only.

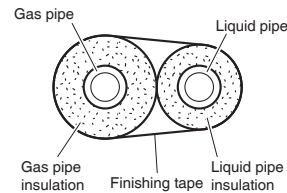

- Be sure to insulate both the gas and liquid piping and observe the insulation dimensions as below.

	Piping size	Minimum bend radius	Piping thickness	Thermal insulation size	Thermal insulation thickness
Gas side	O.D. 3/8 inch (9.5mm)	1-3/16 inch (30mm) or more	0.031 inch (0.8mm) (C1220T-O)	I.D. 15/32-19/32 inch (12-15mm)	13/32 inch (10mm) Min.
	O.D. 1/2 inch (12.7mm)	1-9/16 inch (40mm) or more		I.D. 9/16-5/8 inch (14-16mm)	
Liquid side	O.D. 1/4 inch (6.4mm)	1-3/16 inch (30mm) or more		I.D. 5/16-13/32 inch (8-10mm)	

- Use separate thermal insulation pipes for gas and liquid refrigerant pipes.

7. Checking for gas leakage

- 1) Check for leakage of gas after air purging.
- 2) Refer to the section on pressure test and evacuating system in the installation manual for the outdoor unit.

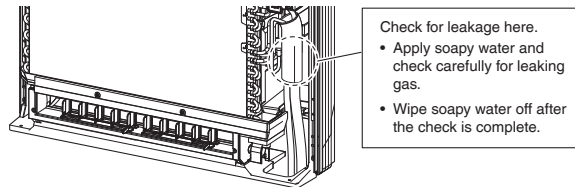

8. Attaching the connection pipe

- Attach the pipe after checking for gas leakage, described above.

 - 1) Cut the insulated portion of the on-site piping, matching it up with the connecting portion.
 - 2) Secure the slit on the refrigerant piping side with the butt joint on the auxiliary piping using the tape, making sure there are no gaps.
 - 3) Wrap the slit and the butt joint with the (D) insulation tape, making sure there are no gaps.

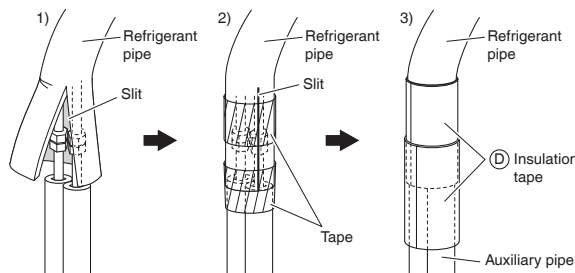

⚠ CAUTION

- Insulate the joint of the pipes securely. Incomplete insulation may lead to water leakage.
- Push the pipe inside so it does not place undue force on the front grille.

9. Wiring

Refer to the installation manual for the outdoor unit also.

⚠ WARNING

- Do not use tapped wires, extension cords, or starburst connections, as they may cause overheating, electric shock, or fire.
- Do not use locally purchased electrical parts inside the product. (Do not branch the power for the drain pump, etc., from the terminal block.) Doing so may cause electric shock or fire.
- Do not connect the power wire to the indoor unit. Doing so may cause electric shock or fire.

⚠ CAUTION

Recommend stranded cable for interunit wiring. Local code always supersedes recommendation.

- For stranded wires, make sure to use the round crimp-style terminal for connection to the power supply terminal block. Place the round crimp-style terminals on the wires up to the covered part and secure in place.

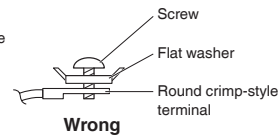
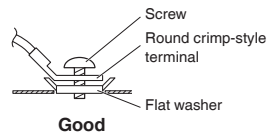
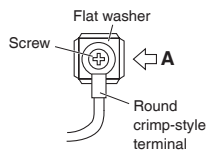
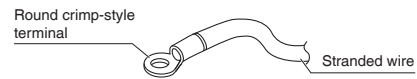

Arrow view A

- If solid core wire must be used, be sure to curl the end of the lead. Improper work may cause heat and fire.

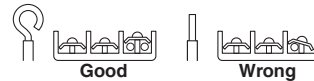

Indoor Unit Installation

With a multi indoor unit , install as described in the installation manual supplied with the multi outdoor unit.

- Live the sensor securing plate, remove the front electrical wiring box cover, and connect the branch wiring to the terminal block.
 - 1) As shown in the illustration, insert the wires including the ground wire into the conduit and secure them with lock nut onto the conduit mounting plate.
 - 2) Strip wire ends (3/4 inch (20mm)).
 - 3) Match wire colours with terminal numbers on indoor and outdoor unit's terminal blocks and firmly secure the wires in the corresponding terminals with the screws.
 - 4) Connect the ground wires to the corresponding terminals.
 - 5) Pull the wires lightly to make sure they are securely connected.
 - 6) Make sure that the wires do not come in contact with the metal conduit for the heat exchanger.
 - 7) In case of connecting to an adapter system, run the remote controller cable and attach the S21. (Refer to "10. When connecting to an HA system" on page 16.)

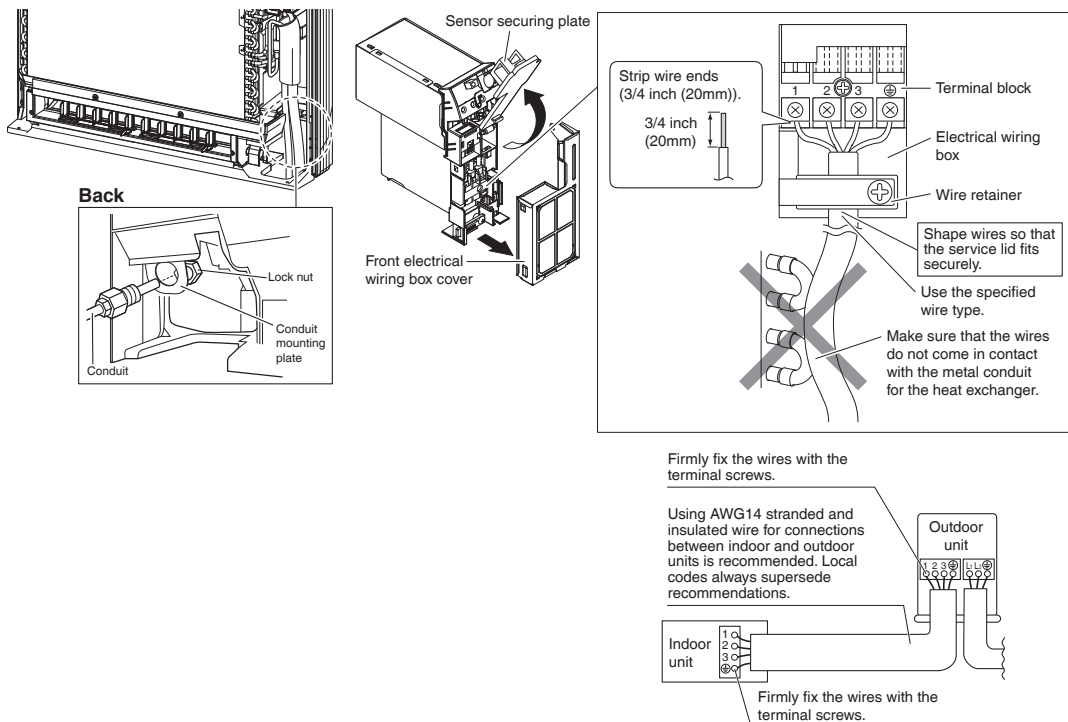

10. When connecting to an HA system

- 1) Remove the front panel and the front grille. (Refer to "4-1. Preparation" on page 8.)
- 2) Open up the sensor securing plate. (See Fig. 3)
- 3) Remove the front electrical wiring box cover (4 tabs). (See Fig. 3)
- 4) Remove connectors ① ② ③. (See Fig. 4 and Fig. 5)
- 5) After removing the ground wires (2 screws), remove the electrical wiring box (1 screw). (See Fig. 6)
- 6) Remove the thermistor. (See Fig. 7)
- 7) Remove the side electrical wiring box cover (7 tabs). (See Fig. 3)
- 8) Cut off the pins using a nipper. (See Fig. 3)
- 9) Wire and connect the HA connection cord to the S21 connector. (See Fig. 3)
- 10) Install the side electrical wiring box cover while being careful not to pinch the HA connection cord or ground wires (7 tabs).
- 11) Attach the thermistor.
- 12) Install the ground wires (2 screws) and the electrical wiring box (1 screw).
- 13) Install the connectors ① ② and guide the cord as shown in the figure. (See Fig. 4)
- 14) Install connector ③ and guide the cord as shown in the figure. (See Fig. 5)
- 15) Attach the front electrical wiring box cover (4 tabs), and close the sensor securing plate.
- 16) Attach the front panel and the front grille as they were.

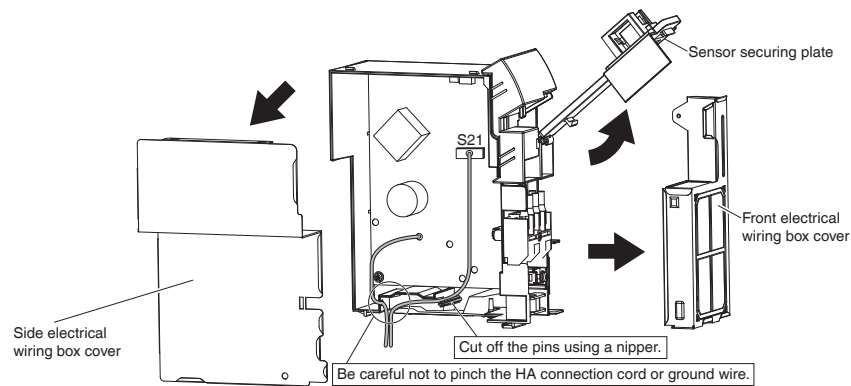

Fig. 3

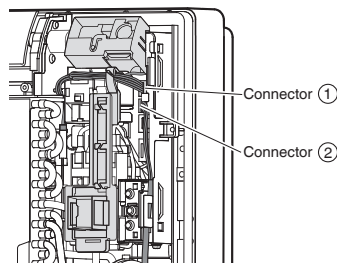

Fig. 4

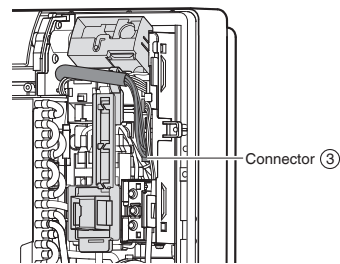

Fig. 5

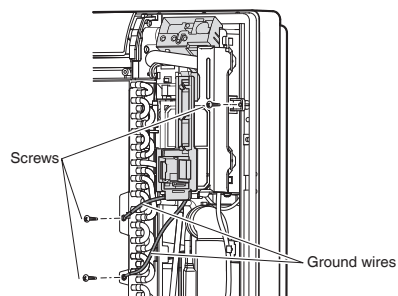

Fig. 6

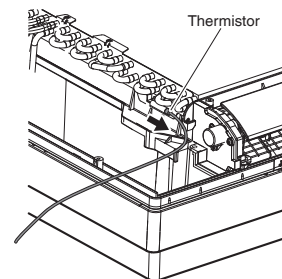
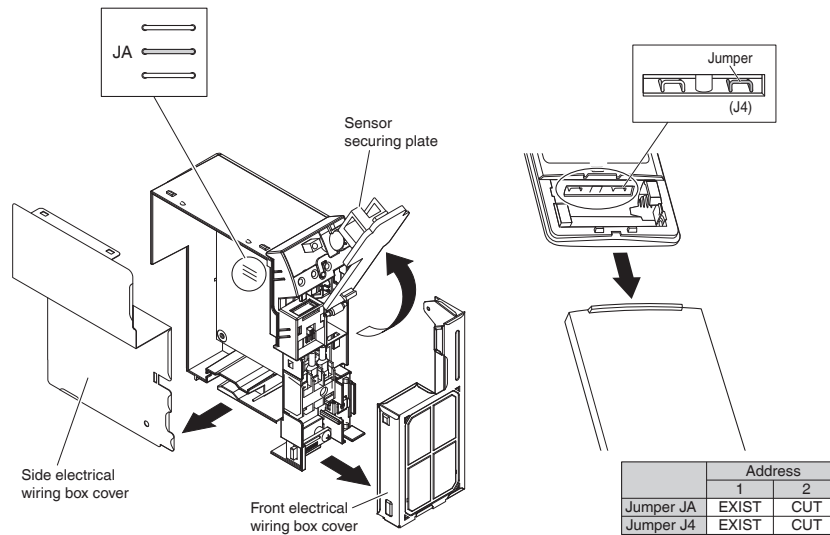

Fig. 7

Indoor Unit Installation

11. How to set the different addresses

- When 2 indoor units are installed in 1 room, the 2 wireless remote controllers can be set for different addresses. Change the address setting of one of the 2 units.
When cutting the jumper be careful not to damage any of the surrounding parts.
- 1) Remove the electrical wiring box. (Refer to "10. When connecting to an HA system" on page 16 steps 1)-7).)
 - 2) Cut the address jumper (JA) on the printed circuit board.
 - 3) Cut the address jumper (J4) in the remote controller.
 - 4) Attach the electrical wiring box as they were. (Refer to "10. When connecting to an HA system" on page 16 steps 10)-15).)
 - 5) Attach the front panel and the front grille as they were.



Trial Operation and Testing

1. Trial operation and testing

- Trial operation should be carried out in either COOL or HEAT operation.

1-1. Measure the supply voltage and make sure that it is within the specified range.







**1-2. In COOL operation, select the lowest programmable temperature;
in HEAT operation, select the highest programmable temperature.**

1-3. Carry out the trial operation following the instructions in the operation manual to ensure that all functions and parts, such as the movement of the flap, are working properly.

- To protect the air conditioner, restart operation is disabled for 3 minutes after the system has been turned off.

1-4. After trial operation is complete, set the temperature to a normal level (78°F to 82°F (26°C to 28°C) in COOL operation, 68°F to 75°F (20°C to 24°C) in HEAT operation).

- When operating the air conditioner in COOL operation in winter, or HEAT operation in summer, set it to the trial operation mode using the following method.

- 1) Press , , and  at the same time.
- 2) Press , select “7””, and press  for confirmation.
- 3) Press  to turn on the system.

- Trial operation will stop automatically after about 30 minutes.

To stop the operation, press .

- Some of the functions cannot be used in the trial operation mode.

- The air conditioner draws a small amount of power in its standby mode. If the system is not to be used for some time after installation, shut off the circuit breaker to eliminate unnecessary power consumption.
- If the circuit breaker trips to shut off the power to the air conditioner, the system will restore the original operation mode when the circuit breaker is opened again.



2. Test items

Test Items	Symptom	Check
Indoor and outdoor units are installed securely.	Fall, vibration, noise	
No refrigerant gas leaks.	Incomplete cooling/heating function	
Refrigerant gas and liquid pipes and indoor drain hose extension are thermally insulated.	Water leakage	
Draining line is properly installed.	Water leakage	
System is properly grounded.	Electrical leakage	
Only specified wires are used for all wiring, and all wires are connected correctly.	No operation or burn damage	
Indoor or outdoor unit's air inlet or air outlet are unobstructed.	Incomplete cooling/heating function	
Stop valves are opened.	Incomplete cooling/heating function	
Indoor unit properly receives remote control commands.	No operation	
 will be displayed when the MODE button is pressed.	No heating	

1.5 CDMQ, FDMQ

Contents

Safety Considerations	1	8. Drain piping work.....	8
Before Installation	3	9. Wiring	11
Accessories	3	10. Duct work	15
Choosing an Installation Site	4	Refrigerant Piping Work	16
Indoor Unit Installation	5	1. Flaring the pipe end.....	16
1. Check the relation of location between the ceiling opening and the indoor unit suspension bolts. (unit: inch (mm))	5	2. Refrigerant piping	16
2. Mount canvas ducts, sound absorbing material and anti-vibration rubber.....	6	Field Settings	18
3. The indoor unit is set to standard external static pressure.....	6	1. Setting remote controller	18
4. Open installation holes (in the case of installation onto the existing ceiling).....	6	2. Settings for external static pressure	18
5. Installing the suspension bolts	6	3. Setting for options.....	19
6. In the case of changing the preset suction to underside suction, replace the chamber cover and the suction flange.....	6	4. Setting air filter sign.....	19
7. Installing the indoor unit	7	5. When implementing group control.....	19
		Trial Operation and Testing	20
		1. Trial operation and testing	20
		2. Test items	21
		3. How to diagnose for malfunction	23
		4. Malfunction code	23

The pictures in this document are for illustrative purposes only.

Safety Considerations

Refer also to the General Safety Considerations in the separate booklet.



Read the precautions in this manual carefully before operating the unit.

Read these **Safety Considerations for Installation** carefully before installing an air conditioner or heat pump. After completing the installation, make sure that the unit operates properly during the startup operation.

Instruct the user on how to operate and maintain the unit. Inform users that they should store this installation manual with the operation manual for future reference.

Always use a licensed installer or contractor to install this product. Improper installation can result in water or refrigerant leakage, electric shock, fire, or explosion.

Meanings of **DANGER**, **WARNING**, **CAUTION**, and **NOTE** Symbols:

 **DANGER** Indicates an imminently hazardous situation which, if not avoided, will result in death or serious injury.

 **WARNING** Indicates a potentially hazardous situation which, if not avoided, could result in death or serious injury.

 **CAUTION** Indicates a potentially hazardous situation which, if not avoided, may result in minor or moderate injury. It may also be used to alert against unsafe practices.

 **NOTE** Indicates situations that may result in equipment or property damage accidents only.

 **DANGER** _____

- Refrigerant gas is heavier than air and replaces oxygen. A massive leak can lead to oxygen depletion, especially in basements, and an asphyxiation hazard could occur leading to serious injury or death.
- Do not ground units to water pipes, gas pipes, telephone wires, or lightning rods as incomplete grounding can cause a severe shock hazard resulting in severe injury or death. Additionally, grounding to gas pipes could cause a gas leak and potential explosion causing severe injury or death.

- If refrigerant gas leaks during installation, ventilate the area immediately. Refrigerant gas may produce toxic gas if it comes into contact with fire. Exposure to this gas could cause severe injury or death.
- After completing the installation work, check that the refrigerant gas does not leak throughout the system.
- Do not install unit in an area where flammable materials are present due to risk of explosions that can cause serious injury or death.
- Safely dispose all packing and transportation materials in accordance with federal/state/local laws or ordinances. Packing materials such as nails and other metal or wood parts, including plastic packing materials used for transportation may cause injuries or death by suffocation.

 **WARNING** _____

- Only qualified personnel licensed or certified in their jurisdiction must carry out the installation work. Installation must be done in accordance with this installation manual. Improper installation may result in water leakage, electric shock, or fire.
- When installing the unit in a small room, take measures to keep the refrigerant concentration from exceeding allowable safety limits. Excessive refrigerant leaks, in the event of an accident in a closed ambient space, can lead to oxygen deficiency.
- Use only specified accessories and parts for installation work. Failure to use specified parts may result in water leakage, electric shock, fire, or the unit falling.
- Install the air conditioner or heat pump on a foundation strong enough that it can withstand the weight of the unit. A foundation of insufficient strength may result in the unit falling and causing injuries.
- Take into account strong winds, typhoons, or earthquakes when installing. Improper installation may result in the unit falling and causing accidents.
- Make sure that a separate power supply circuit is provided for this unit and that all electrical work is carried out by qualified personnel licensed or certified in their jurisdiction according to local, state, and national regulations. An insufficient power supply capacity or improper electrical construction may lead to electric shock or fire.
- Make sure that all wiring is secured, that specified wires are used, and that no external forces act on the terminal connections or wires. Improper connections or installation may result in fire.

- When wiring, position the wires so that the electrical wiring box cover can be securely fastened. Improper positioning of the electrical wiring box cover may result in electric shock, fire, or the terminals overheating.
- Before touching electrical parts, turn off the unit.
- The circuit must be protected with safety devices in accordance with local and national codes, i.e. a circuit breaker.
- Securely fasten the outdoor unit terminal cover (panel). If the terminal cover/panel is not installed properly, dust or water may enter the outdoor unit causing fire or electric shock.
- When installing or relocating the system, keep the refrigerant circuit free from substances other than the specified refrigerant (R410A) such as air. Any presence of air or other foreign substance in the refrigerant circuit can cause an abnormal pressure rise or rupture, resulting in equipment damage and even injury.
- Do not change the setting of the protection devices. If the pressure switch, thermal switch, or other protection device is shorted and operated forcibly, or parts other than those specified by Daikin are used, fire or explosion may occur.
- Do not use means to accelerate the defrosting process (if possible) or to clean, other than those recommended by the manufacturer.
- The appliance must be stored in a room without continuously operating ignition sources (for example: open flames, an operating gas appliance or an operating electric heater).
- Do not pierce or burn.
- Be aware that refrigerants may not contain an odor.
- Comply with national gas regulations.

CAUTION

- Do not touch the switch with wet fingers. Touching a switch with wet fingers can cause electric shock.
- Do not allow children to play on or around the unit to prevent injury.
- Wear adequate personal protective equipment (protective gloves, safety glasses,...) when installing, maintaining or servicing the system.
- The heat exchanger fins are sharp enough to cut. To avoid injury, wear gloves or cover the fins while working around them.
- Do not touch the refrigerant pipes during and immediately after operation as the refrigerant pipes may be hot or cold, depending on the condition of the refrigerant flowing through the refrigerant piping, compressor, and other refrigerant cycle parts. Your hands may suffer burns or frostbite if you touch the refrigerant pipes. To avoid injury, give the pipes time to return to normal temperature or, if you must touch them, be sure to wear proper gloves.
- Install drain piping to ensure proper drainage. Improper drain piping may result in water leakage and property damage.
- Insulate piping to prevent condensation.
- Be careful when transporting the product.
- Do not turn off the power immediately after stopping operation. Always wait for at least 5 minutes before turning off the power. Otherwise, water leakage may occur.
- Do not use a charging cylinder. Using a charging cylinder may cause the refrigerant to deteriorate.
- Refrigerant R410A in the system must be kept clean, dry, and tight.
 - (a) Clean and Dry -- Foreign materials (including mineral oils such as SUNISO oil or moisture) should be prevented from getting into the system.

- (b) Tight -- R410A does not contain any chlorine, does not destroy the ozone layer, and does not reduce the earth's protection against harmful ultraviolet radiation. R410A can contribute to the greenhouse effect if it is released. Therefore take proper measures to check for the tightness of the refrigerant piping installation. Read the chapter *Refrigerant Piping Work* and follow the procedures.
- Since R410A is a blend, the required additional refrigerant must be charged in its liquid state. If the refrigerant is charged in a state of gas, its composition can change and the system will not work properly.
- The indoor unit is for R410A. See the catalog for outdoor models that can be connected. Normal operation is not possible when connected to non-compatible outdoor units.
- Remote controller (wireless kit) transmitting distance can be shorter than expected in rooms with electronic fluorescent lamps (inverter or rapid start types). Install the indoor unit far away from fluorescent lamps as much as possible.
- Indoor units are for indoor installation only. Outdoor units can be installed either outdoors or indoors.
- Do not install the air conditioner or heat pump in the following locations:
 - (a) Where a mineral oil mist or oil spray or vapor is produced, for example, in a kitchen. Plastic parts may deteriorate and fall off or result in water leakage.
 - (b) Where corrosive gas, such as sulfurous acid gas, is produced. Corroding copper pipes or soldered parts may result in refrigerant leakage.
 - (c) Near machinery emitting electromagnetic waves. Electromagnetic waves may disturb the operation of the control system and cause the unit to malfunction.
 - (d) Where flammable gas may leak, where there is carbon fiber, or ignitable dust suspension in the air, or where volatile flammables such as thinner or gasoline are handled. Operating the unit in such conditions can cause a fire.
- Take adequate measures to prevent the outdoor unit from being used as a shelter by small animals. Small animals making contact with electrical parts can cause malfunctions, smoke, or fire. Instruct the user to keep the area around the unit clean.
- Servicing shall be performed only as recommended by the manufacturer and licensed or certified in their jurisdiction.

NOTE

- The indoor unit should be positioned where the unit and inter-unit wires (outdoor to indoor) are at least 3.3ft (1m) away from any televisions or radios. (The unit may cause interference with the picture or sound.) Depending on the radio waves, a distance of 3.3ft (1m) may not be sufficient to eliminate the noise.
- Dismantling the unit, treatment of the refrigerant, oil and additional parts must be done in accordance with the relevant local, state, and national regulations.
- Only use tools for R410A, such as a gauge manifold, charge hose, gas leak detector, reverse flow check valve, refrigerant charge base, vacuum gauge, or refrigerant recovery equipment.
- If the conventional refrigerant and refrigerator oil are mixed in R410A, the refrigerant may deteriorate.
- This air conditioner or heat pump is an appliance that should not be accessible to the general public.
- As maximum allowable pressure is 604psi (4.17MPa), the wall thickness of field-installed pipes should be selected in accordance with the relevant local, state, and national regulations.

FTN005-U













Before Installation

- Leave the unit inside its packaging until you reach the installation site. Where unpacking is unavoidable, use a sling of soft material or protective plates together with a rope when lifting, this to avoid damage or scratches to the unit. When unpacking the unit or when moving the unit after unpacking, be sure to lift the unit by holding on to the hanger bracket without exerting any pressure on other parts, especially on refrigerant piping, drain piping and other resin parts.
- Refer to the installation manual of the outdoor unit for items not described in this manual.
- Caution concerning refrigerant series R410A:
The connectable outdoor units must be designed exclusively for R410A.

Precautions

- Do not install or operate the unit in places mentioned below.
 - Places with mineral oil, or filled with oil vapor or spray like in kitchens. (Plastic parts may deteriorate.)
 - Where corrosive gas like sulphurous gas exists. (Copper tubing and brazed spots may corrode.)
 - Where volatile flammable gas like thinner or gasoline is used.
 - Where machines generating electromagnetic waves exist. (Control system may malfunction.)
 - Where the air contains high levels of salt such as near the ocean and where voltage fluctuates a lot (e.g. in factories). Also inside vehicles or vessels.
- Do not install accessories on the casing directly. Drilling holes in the casing may damage electrical wires and consequently cause fire.
- Take off static electricity from the body when carrying out wiring and the electrical wiring box cover is removed. The electric parts may be damaged.

Accessories

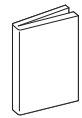
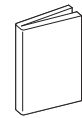
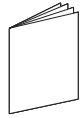
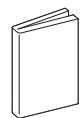
<p>(A) Clamp metal</p>  <p>1</p>	<p>(B) Drain hose</p>  <p>1</p>	<p>(C) Duct flange connection screw</p>  <p>10*</p>	<p>(D) Fitting insulation (for liquid pipe)</p>  <p>Thin</p> <p>1</p>
<p>(E) Fitting insulation (for gas pipe)</p>  <p>Thick</p> <p>1</p>	<p>(F) Sealing pad (large) (Dark gray)</p>  <p>1</p>	<p>(G) Sealing pad (medium) (Dark gray)</p>  <p>2</p>	<p>(H) Clamp</p>  <p>8</p>
<p>(J) Washer fixing plate</p>  <p>4</p>	<p>(K) Wire sealing pad (small) (Gray)</p>  <p>2</p>	<p>(L) Washer (for hanger bracket)</p>  <p>8</p>	<p>(M) Conduit mounting plate</p>  <p>1</p>
<p>(N) Operation manual</p>  <p>1</p>	<p>(P) Installation manual</p>  <p>1</p>	<p>(Q) Warranty</p>  <p>1</p>	<p>(R) General safety considerations</p>  <p>1</p>

*The 15/18/24 class models have 18 screws.

Optional Accessories

A remote controller is required for the indoor unit.

- There are 2 types of remote controllers: wired and wireless. Select a remote controller from the table according to user request and install in an appropriate place.

Remote controller type	Model name
Wired type	BRC1E73
Wireless type	BRC082A43

- If you wish to use a remote controller that is not listed in the table, select a suitable remote controller after consulting catalogs and technical materials.
- The indoor unit can be switched to lower suction. (Refer to “6. In the case of changing the preset suction to underside suction, replace the chamber cover and the suction flange.” (page 6))
The side cover plate (KDBD63A160) is required in the case of wiring from the bottom for underside suction. For installation work, refer to the instruction sheet provided with the side cover plate.

Choosing an Installation Site

Hold the unit by the 4 hanger brackets when opening the box and moving it, and do not exert pressure on to any other part, piping (refrigerant, drain, etc.), and air outlet flange.

If the temperature or humidity inside the ceiling might rise above 86°F (30°C) or RH 80%, respectively, add extra insulation to the unit.

Use polyethylene foam as insulation and make sure it is at least 3/8 inch (10mm) thick and fits inside the ceiling opening.

- Before choosing the installation site, obtain user approval.
The indoor unit should be positioned in a place where:
 - 1) both the air inlet and air outlet are unobstructed,
 - 2) the unit is not exposed to direct sunlight,
 - 3) the unit is away from the source of heat or steam,
 - 4) there is no source of machine oil vapor (this may shorten the indoor unit service life),
 - 5) cool/warm air is circulated throughout the room,
 - 6) the unit is away from electronic ignition type fluorescent lamps (inverter or rapid start type) as they may affect the remote controller range,
 - 7) no laundry equipment is nearby,
 - 8) drainage can be performed without any problem,
 - 9) the weight of the indoor unit can be adequately supported,
 - 10) the wall and the ceiling's lower surface are not significantly tilted,
 - 11) room can be left for installation and service work,
 - 12) there is no risk of flammable gas leaking,
 - 13) the required length of indoor-outdoor piping would not exceed the specified maximum length (see the installation manual that came with the outdoor unit for details).

[Installation Space Requirements]

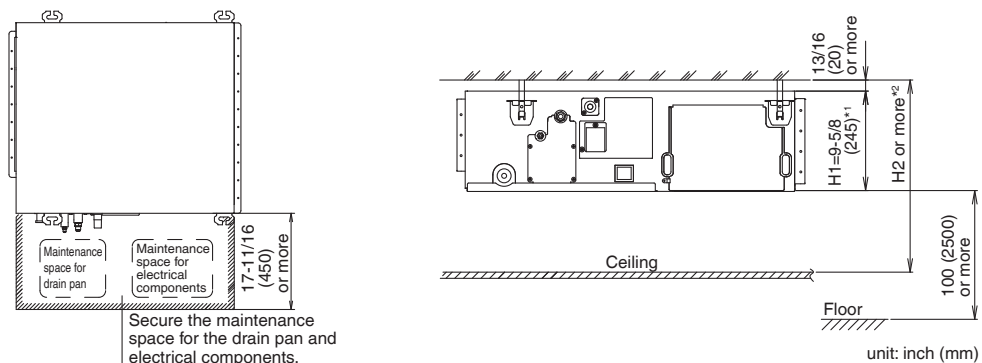

*1 Dimension H1 indicates the product height.

*2 Secure a downward slope of at least 1/100 specified in "8. Drain piping work" (page 8) and determine dimension H2.

<Failure example>

If there is an obstacle in the airflow path or proper installation space is not provided, the indoor unit will cause air volume reduction and take in air blown out of the indoor unit, thus resulting in performance degradation or turning the thermostat OFF frequently.

Use suspension bolts for installation. Check whether the ceiling is strong enough to support the weight of the unit or not. If there is a risk, reinforce the ceiling before installing the unit.

Indoor Unit Installation

1. Check the relation of location between the ceiling opening and the indoor unit suspension bolts. (unit: inch (mm))

Provide one of the following service spaces for the maintenance and inspection of the electrical wiring box and drain pump or for other services.

If a space of 300mm or more under the product can be secured

- Inspection ports 1 and 2 (17-11/16 inch (450mm) × 17-11/16 inch (450mm)) and a minimum space of 11-13/16 inch (300mm) at the bottom of the product.

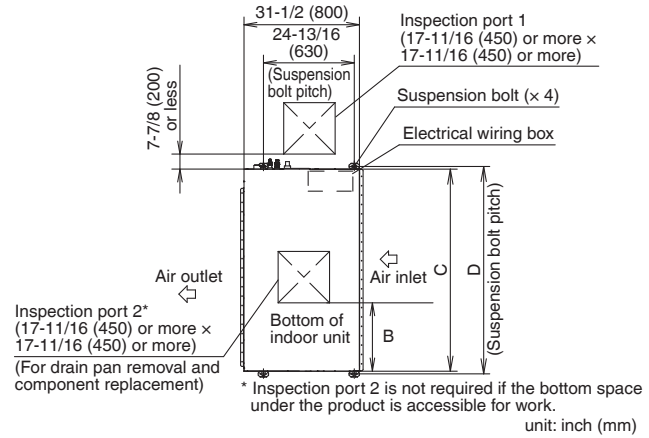
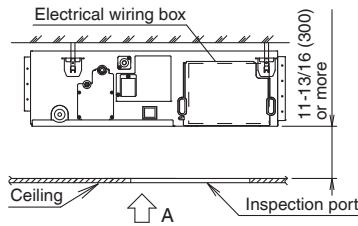

View A

If a space of 300mm or more under the product can not be secured

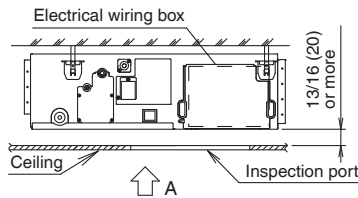

- 1) Inspection port 1 (17-11/16 inch (450mm) × 17-11/16 inch (450mm)) on the electrical wiring box side and inspection port 2 on the bottom of the product. (View A-1))

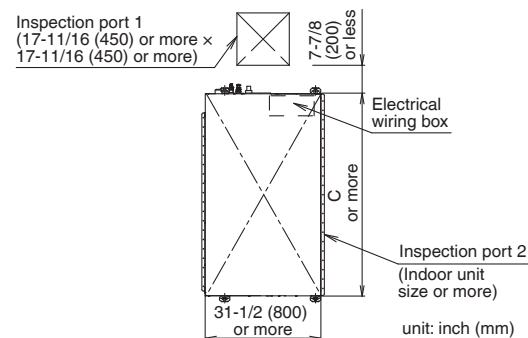

View A-1)

- 2) Inspection port 3 on the bottom of the product and on the bottom side of the electrical wiring box. (View A-2))

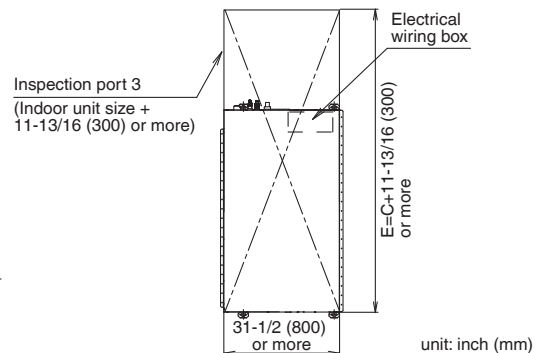

View A-2)

	B	C	D	E
07/09/12 class	(0)	27-9/16 (700)	29-1/16 (738)	39-3/8 (1000)
15/18/24 class	1-15/16 (50)	39-3/8 (1000)	40-7/8 (1038)	51-3/16 (1300)

unit: inch (mm)

2. Mount canvas ducts, sound absorbing material and anti-vibration rubber.

- Mount canvas ducts to the air outlet and inlet so that the vibration of the indoor unit will not be transmitted to the ducts or ceiling.
Furthermore, attach sound absorbing material (thermal insulation material) to the duct inner walls and anti-vibration rubber to the suspension bolts (refer to “10. Duct work” (page 15)).

3. The indoor unit is set to standard external static pressure.

- If external static pressure is higher or lower than the standard set value, the remote controller may be used to make on-site setting change in the external static pressure.
Refer to “Field settings” (page 18).

4. Open installation holes (in the case of installation onto the existing ceiling).

- Open the installation holes on the ceiling of the installation location, and work on the refrigerant piping, drain piping, remote controller wiring, and wiring between the indoor and outdoor units to the piping connection port and wiring connection port of the indoor unit (refer to each piping and wiring procedure items).
- Ceiling framework reinforcement may be required in order to keep the ceiling horizontal and prevent ceiling vibration after opening the ceiling holes. For details, consult your building and upholstery work contractors.

5. Installing the suspension bolts

(Use either a M8-M10 size bolt or the equivalent)
Use a hole-in anchor for existing ceilings, and a sunken insert, sunken anchor or other field supplied parts for new ceilings to reinforce the ceiling to bear the weight of the unit.
Adjust clearance (2-4 inch (50-100mm)) from the ceiling before proceeding further.

- All the above parts are field supplied.

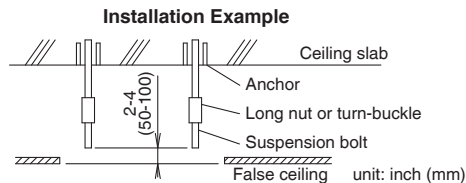

6. In the case of changing the preset suction to underside suction, replace the chamber cover and the suction flange.

1. Remove the suction flange and chamber cover.
2. Replace the suction flange and the chamber cover.

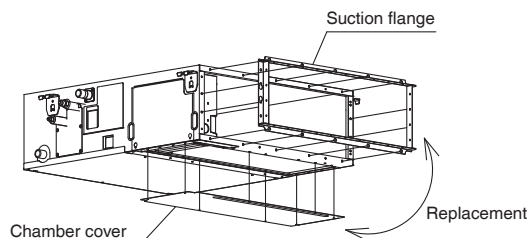

⚠ CAUTION

- Secure a sufficient maintenance space for the drain pan and electrical components before installing the indoor unit.
- Secure a sufficient maintenance space for the filter chamber, and peripheral components before installing the indoor unit.

Indoor Unit Installation

7. Installing the indoor unit

When installing optional accessories, read also the installation manual of the optional accessories. Depending on the field conditions, it may be easier to install optional accessories before the indoor unit is installed.

As for the parts to be used for installation work, be sure to use the provided accessories and specified parts designated by Daikin.

1) Install the indoor unit temporarily.

- Attach the hanger bracket to the suspension bolt. Be sure to fix it securely by using a nut and (L) washer from the upper and lower sides of the hanger bracket.

If the (J) washer fixing plate is used, the upper side (L) washer may be protected from falling off.

Securing the hanger bracket

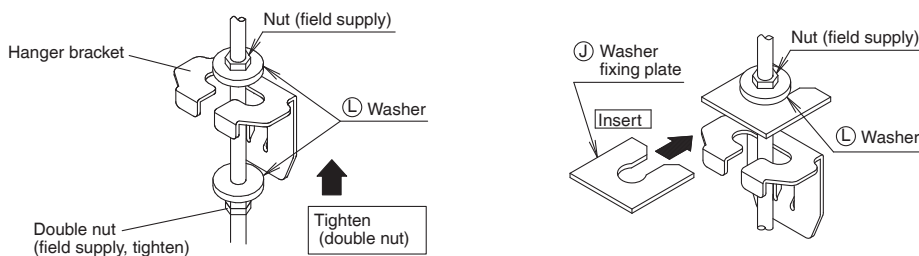

- Keep the air outlet covered with a protective sheet to prevent weld spatter and other foreign materials from entering the indoor unit and damaging the resin drain pan.
(If holes or cracks are generated in the resin drain pan, water can leak.)

2) Adjust the height of the unit.

3) Check the unit is horizontally level.

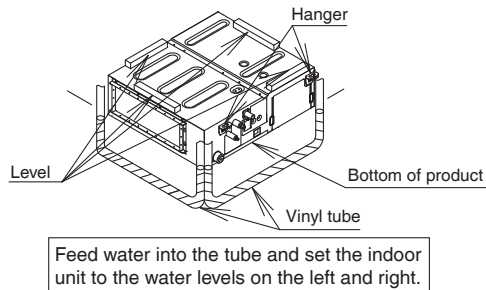

4) Remove the (J) washer fixing plate used for preventing the (L) washer from dropping and tighten the upper side nut.

⚠ CAUTION

- **Install the indoor unit leveled.**

If the indoor unit is inclined and the drain piping side gets high, it may cause malfunction of float switch and result in water leakage.

- **Attach nuts on the upper and lower side of hanger.**

If there is no upper nut and the lower nut is over-tightened, the hanger and the top plate will deform and cause abnormal sound.

- **Do not insert materials other than that specified into the clearance between the hanger and the washer for hanger bracket (11).**

Unless the washers are properly attached, the suspension bolts may come off from the hanger.

⚠ WARNING

The indoor unit must be securely installed on a place that can withstand the mass.

If the strength is insufficient, the indoor unit may fall down and cause injuries.

8. Drain piping work

⚠ CAUTION

- Water pooling in the drainage piping can cause the drain to clog.
- Do not connect the drain piping directly to sewage pipes that smell of ammonia. The ammonia in the sewage might enter the indoor unit through the drain pipes and corrode the heat exchanger.
- Keep in mind that the drain pipe becomes blocked if water collects on it.
- Do not tighten the (A) clamp metal with the torque more than the specified value. The (B) drain hose, the socket or the (A) clamp metal may be damaged.

1. Install of drain piping

- Install the drain piping as shown in the figure and take measures against condensation. Improperly rigged piping could lead to leaks and eventually wet furniture and belongings.
- Keep piping as short as possible and slope it downwards at a gradient of at least 1/100 so that air may not remain trapped inside the pipe.
- Select the piping diameter equal to or larger than (except for riser) that of the connection piping (polyvinyl chloride piping, nominal diameter 1 inch (25mm), outside diameter 1-1/4 inch (32mm)).
- If the drain hose cannot be sufficiently set on a slope, refer to “Precautions for drain raising piping” (page 9).
- To keep the drain hose from sagging, space hanger bracket every 40-60 inch (1000-1500mm).

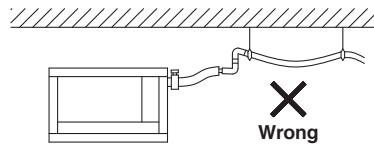
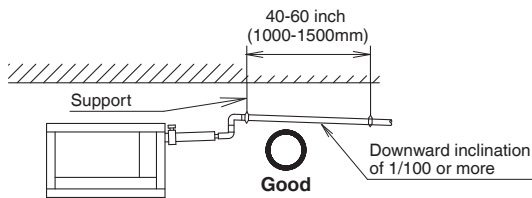

- Make sure to use the attached (B) drain hose and the (A) clamp metal. Insert the (B) drain hose into the drain socket up to the point where the socket diameter becomes larger. Put the (A) clamp metal to the taped hose end and tighten the (A) clamp metal with torque 10.6~13.3lbf • ft (120~150 N•cm).

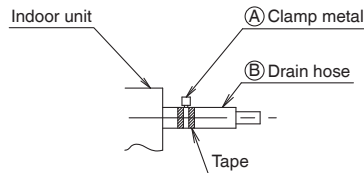

- Wrap the vinyl tape around the end of the (A) clamp metal so that the (F) sealing pad (Large) to be used at the next process may not be damaged with the clamp end or bend the tip of the (A) clamp metal inward as shown.

<In case of sticking vinyl tape>

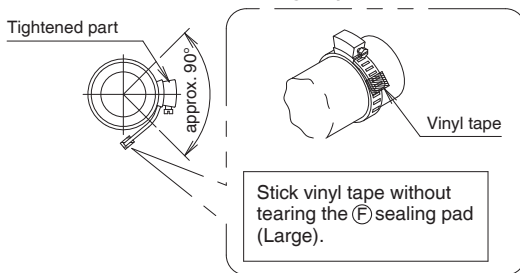

<In case of bending the tip>

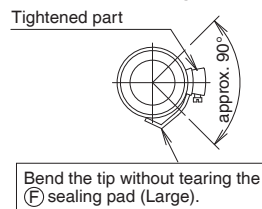

Indoor Unit Installation

Precautions for drain raising piping

- The maximum height of the drain riser is 29-9/16 inch (675mm). Since the drain pump mounted on this indoor unit is a high head type, from the characteristic point of view, the higher the drain riser the lower the draining noise. Therefore, the drain riser of 11-13/16 inch (300mm) or higher is recommended.
- For upward drain piping, keep the horizontal piping distance of 11-13/16 inch (300mm) or less between the drain socket root to the drain riser.

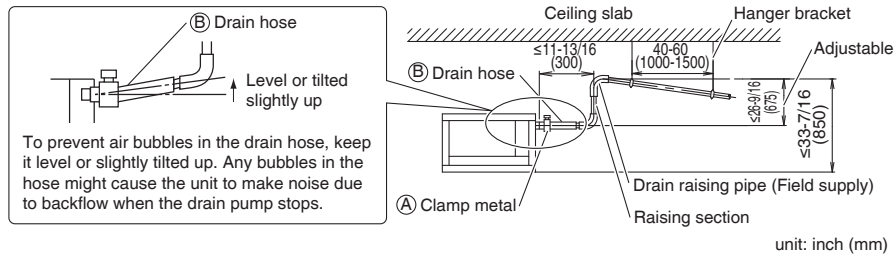

- To ensure no excessive pressure is applied to the included (B) drain hose, do not bend or twist the hose when installing as it could cause leakage.
- If converging multiple drain pipes, install according to the procedure shown below.

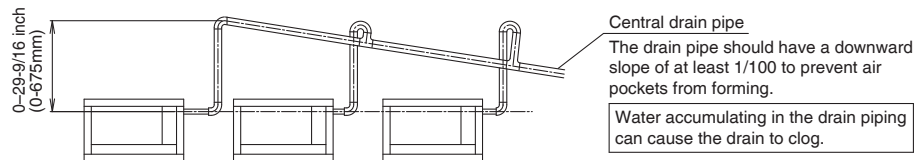

Select converging drain pipes with gauges is suitable for the operating capacity of the unit.

- Positioning the upward drain piping at an angle may cause float switch malfunction and lead to water leakage.
- While replacing with new indoor unit, use the attached new (B) drain hose and the (A) clamp metal. If an old drain hose or a clamp metal is used, it may cause water leakage.

2. After piping work is finished, check if drainage flows smoothly

When electric wiring work is finished

- Gradually pour 1/4 gal of water from the inspection port at the bottom of the drain socket on the left side of the drain socket into the drain pan giving caution to avoid splashing water on the electric components such as drain pump and confirm drainage by operating the indoor unit under cooling mode according to **Field settings**.

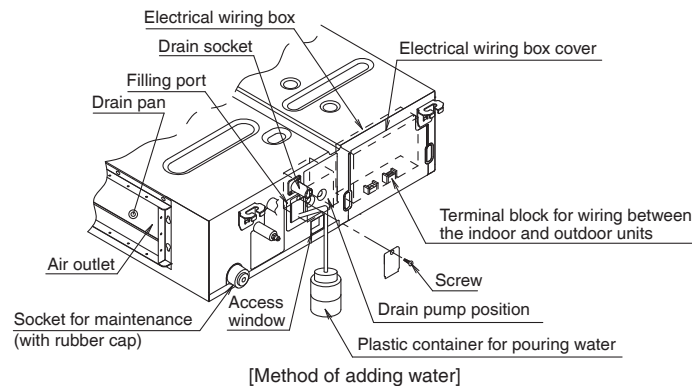

When electric wiring work is not finished

- The electric wiring works (including grounding) must be carried out by a qualified electrician.
- If a qualified person is not present, after the electric wiring work is finished, check the drainage according to the method specified in [When the electric wiring work is finished].
 1. Open the electrical wiring box cover and connect the ground wiring to the ground terminal.
 2. Make sure the electrical wiring box cover is closed before turning on the power supply.
 - Throughout the whole process, carry out the work giving caution to the wiring around the electrical wiring box so that the connectors may not come off.
 3. Gradually pour 1 litre of water from the air outlet on the left side of the drain socket into the drain pan giving caution to avoid splashing water on the electric components such as drain pump.
 4. When the power supply is turned on, the drain pump will operate. Drainage can be checked at the transparent part of the drain socket.

(The drain pump will automatically stop after 10 minutes.)

The drainage of water can be confirmed with water level change in the drain pan through the access window.

 - Do not connect the drain piping directly to the sewage that gives off ammonia odor. The ammonia in the sewage may go through the drain piping and corrode the heat exchanger of the indoor unit.
 - Do not apply external force to the float switch. (It may result in malfunction)
 - Do not touch the drain pump. Touching the drain pump may cause electric shock.
 5. Turn off the power supply after checking drainage, and remove the power supply wiring.
 6. Attach the electrical wiring box cover as before.

3. Sweating may occur and result in water leakage. Therefore, make sure to insulate the following 2 locations (drain piping that laid indoors and drain sockets).

- Use the provided (F) sealing pad (large), and perform the thermal insulation of the (A) clamp metal and (B) drain hose after checking the drainage of water.

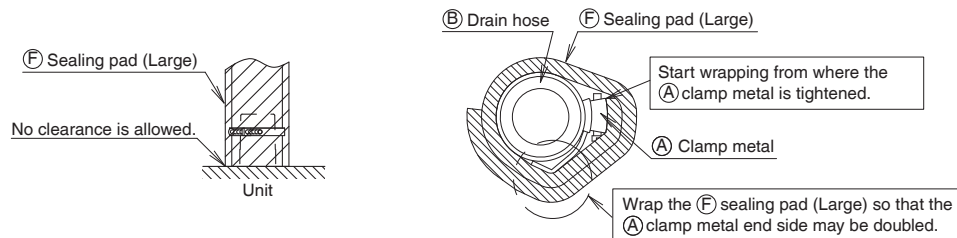

Indoor Unit Installation

9. Wiring

1. General instructions

- Make certain that all electric wiring work is carried out by qualified personnel according to the applicable legislation and this installation manual, using a separate dedicated circuit. Insufficient capacity of the power supply circuit or improper electrical construction may lead to electric shock or a fire.
- Make sure to install a ground fault circuit interrupter. Failure to do so may cause electric shock and a fire.
- Do not turn on the power supply (branch switch, branch overcurrent circuit breaker) until all the works are finished.
- Multiple number of indoor units are connected to one outdoor unit. Name each indoor unit as A-unit, B-unit and the like. When these indoor units are wired to the outdoor unit, always wire the indoor unit to the terminal indicated with the same symbol on the terminal block. If the wiring and the piping are connected to the different indoor units and operated, it will result in malfunction.
- Make sure to ground the air conditioner. Grounding resistance should be according to applicable legislation.
- Do not connect the ground wiring to gas or water pipings, lightning conductor or telephone ground wiring.
 - Gas pipingIgnition or explosion may occur if the gas leaks.
 - Water piping.....Hard vinyl tubes are not effective grounds.
 - Lightning conductor or telephone ground wiring.....Electric potential may rise abnormally if struck by a lightning bolt.
- For electric wiring work, refer to also the "WIRING DIAGRAM" attached to the electrical wiring box cover.
- Carry out wiring between the outdoor units, indoor units and the remote controllers according to the wiring diagram.
- Carry out installation and wiring of the remote controller according to the "installation manual" attached to the remote controller.
- Do not touch the Printed Circuit Board assembly. It may cause malfunction.

⚠ WARNING

- Do not use tapped wires, extension cords, or starburst connections, as they may cause overheating, electric shock, or fire.
- Do not use locally purchased electrical parts inside the product. (Do not branch the power for the drain pump, etc., from the terminal block.) Doing so may cause electric shock or fire.
- Do not connect the power wire to the indoor unit. Doing so may cause electric shock or fire.

⚠ CAUTION

- When clamping wiring, use the included clamping material to prevent outside pressure being exerted on the wiring connections and clamp firmly. When doing the wiring, make sure the wiring is neat and does not cause the electrical wiring box cover to stick up, then close the cover firmly.
- Outside the unit, separate the low voltage wiring (remote controller wiring) and high voltage wiring (wiring between units, ground, and other power wiring) at least 2 in. so that they do not pass through the same place together. Proximity may cause electrical interference, malfunctions, and breakage.

2. Wiring example

For the wiring of outdoor units, refer to the installation manual attached to the outdoor units.

Confirm the system type.

- **Multi system:** 2 through 6 (The number of connectable units will vary according to model) indoor units connect to 1 outdoor unit. The indoor unit is controlled by remote controller connected to each indoor unit.

NOTE

1. All transmission wiring except for the remote controller wires is polarized and must match the terminal symbol.
2. In case a shielding wire is to be used, connect a shielded portion with the ⚡ of a remote controller terminal block. (Also, connect the ground for the remote control to a grounded metal part.)

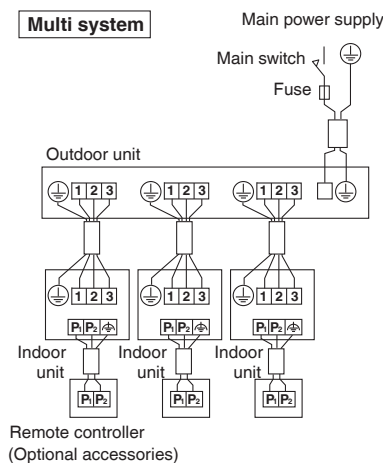

3. Specification for field wire

	Wire	Size	Length
Wiring between units	Recommend stranded and shielded. Local code supersedes recommendation.	AWG 14	-
Remote controller wiring	Sheathed (2 wire)	AWG 18 - 16	Max. 1640ft (500m)*
Wiring to ground terminal	Recommend stranded and shielded. Local code supersedes recommendation.	-	-

* This will be the total extended length in the system when doing group control.

4. Wiring connection method

⚠ CAUTION FOR WIRING

Recommend stranded cable for interunit wiring. Local code always supersedes recommendation.

- For stranded wires, make sure to use the round crimp-style terminal for connection to the power supply terminal block. Place the round crimp-style terminals on the wires up to the covered part and secure in place.

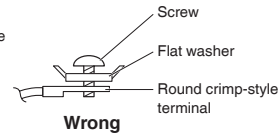
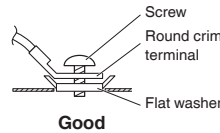
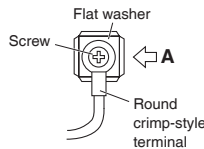
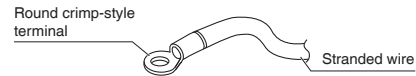

Arrow view A

- If solid core wire must be used, be sure to curl the end of the lead. Improper work may cause heat and fire.

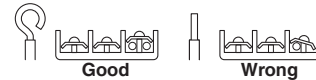

Tightening torque for the terminal blocks

- Use the correct screwdriver for tightening the terminal screws. If the blade of screwdriver is too small, the head of the screw might be damaged, and the screw will not be properly tightened.
- If the terminal screws are tightened too hard, screws might be damaged.
- Refer to the table below for the tightening torque of the terminal screws.

unit: lbf • ft (N • m)

	Tightening torque
Terminal block for remote controller (6P)	0.58 - 0.72 (0.79 - 0.98)
Terminal block for power supply (4P)	0.87 - 1.06 (1.18 - 1.44)

⚠ WARNING

- When wiring, form the wirings orderly so that the electrical wiring box cover can be securely fastened. If the electrical wiring box cover is not in place, the wirings may come out or be sandwiched by the box and the lid and cause electric shock or a fire.

1) Remove the electrical wiring box cover.

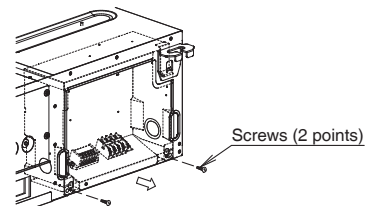

Indoor Unit Installation

2) Attach the conduit to the (M) conduit mounting plate.

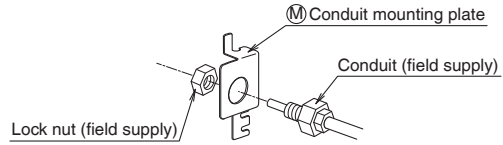

- Attach the (K) wire sealing pad (small) to the conduit, the wiring between the indoor and outdoor units, and the ground wiring.

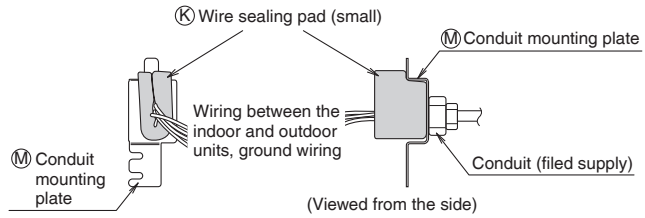

- Loosen the screws (2 points) in part A.

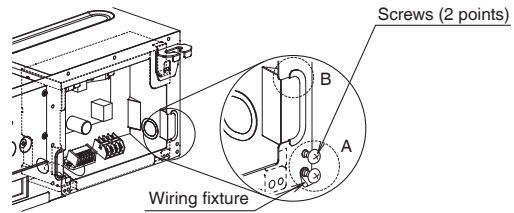

- Insert the hook part of the (M) conduit mounting plate into part B and secure the (M) conduit mounting plate with the screws loosened (2 points).

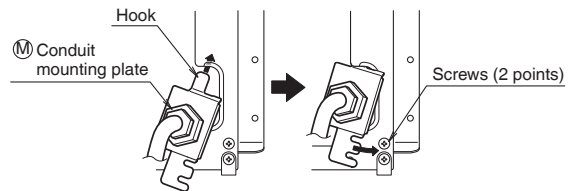

NOTE

Remove the wiring fixture if you have difficulty performing this step.

3) Connect the wiring into the electrical wiring box through the wiring intake beside the electrical wiring box.

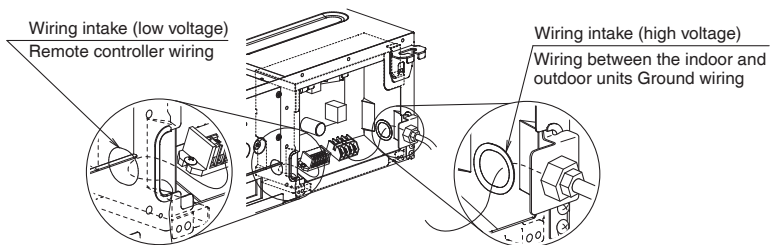

4) Follow the instructions below and perform wiring in the electrical wiring box.

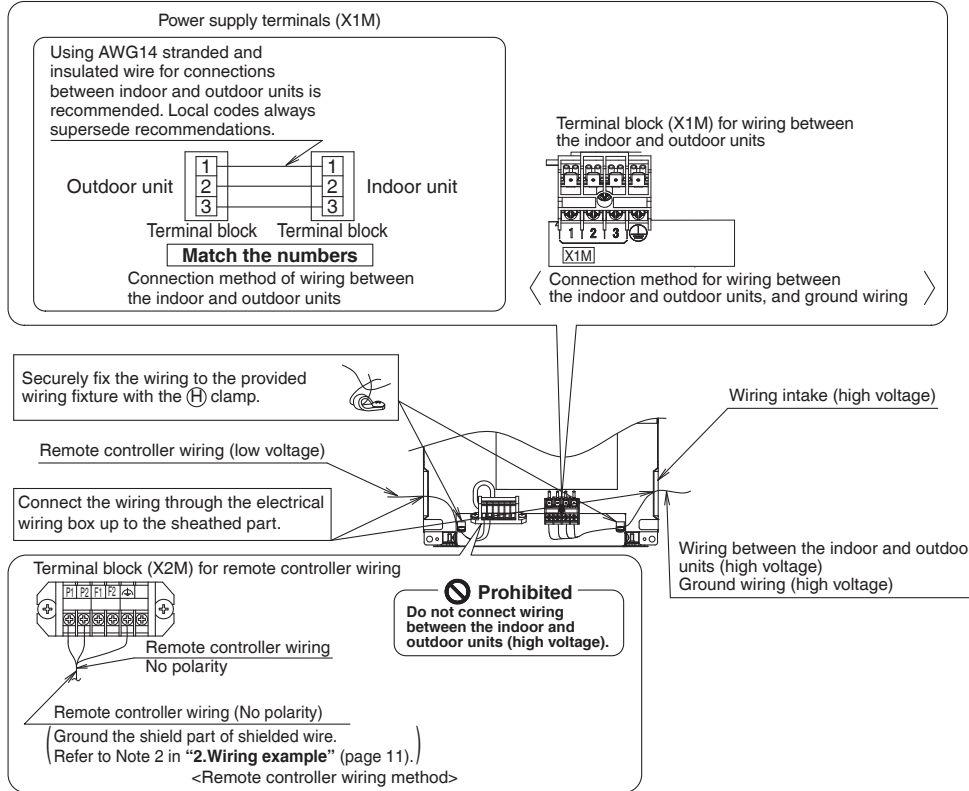

NOTE

Secure the wiring between the wiring intake and conduit with the (H) clamp so that the wiring will not become loose.

5) Mount the electrical wiring box cover and wrap the (K) wire sealing pad (small) so that the wiring through hole will be covered by the sealing pad.

- Seal the clearance around the wirings with putty or insulating material (field supply). (If insects and small animals get into the indoor unit, short-circuiting may occur inside the electrical wiring box.)

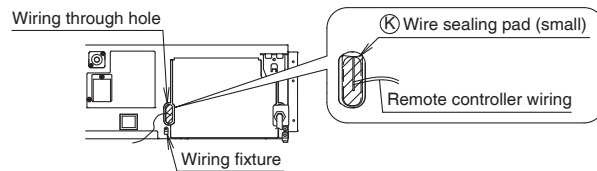

6) Securely fix each wiring with the provided (H) clamp material.

- See the installation manual supplied with the outdoor unit.

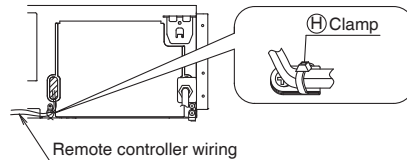

Indoor Unit Installation

10. Duct work

Pay the utmost attention to the following items and conduct the duct work.

- Check that the duct is not in excess of the setting range of external static pressure for the unit. (Refer to the technical datasheet for the setting range.)
- Attach a canvas duct each to the air outlet and air inlet so that the vibration of the equipment will not be transmitted to the duct or ceiling.
Use a sound-absorbing material (insulation material) for the lining of the duct and apply vibration insulation rubber to the suspension bolts.
- At the time of duct welding, perform the curing of the duct so that the sputter will not come in contact with the drain pan for the filter.
- If the metal duct passes through a metal lath, wire lath, or plate of a wooden structure, separate the duct and wall electrically.
- Be sure to heat insulate the duct for the prevention of dew condensation. (Material: Glass wool or styrene foam; Thickness: 1 inch (25mm))
- Be sure to attach the field supply air filter to the air inlet of the unit or field supply inlet in the air passage on the air suction side. (Be sure to select an air filter with a duct collection efficiency of 50 weight percent.)
- Explain the operation and washing methods of the locally procured components (i.e., the air filter, air inlet grille, and air outlet grille) to the user.
- Locate the air outlet grille on the indoor side for the prevention of drafts in a position where indirect contact with people.
- The air conditioner incorporates a function to adjust the fan to rated speed automatically. (Field settings)
Therefore, do not use booster fans midway in the duct.

Connection method of ducts on air inlet and outlet sides.

- Connect the field supply duct in alignment with the inner side of the flange.
- Connect the flange and unit with the © duct flange connection screw.
- Wrap aluminium tape around the flange and duct joint in order to prevent air leakage.

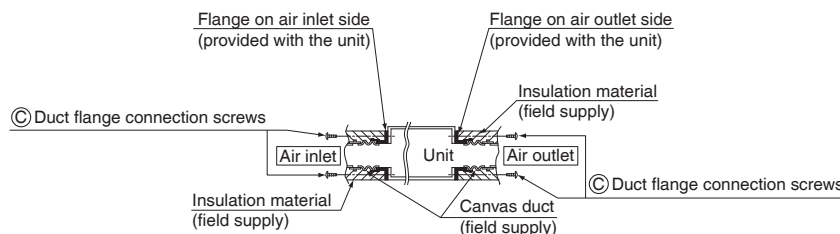

⚠ CAUTION

Connect the flange and unit with the © duct flange connection screw regardless of whether the duct is connected to the air inlet side.

Refrigerant Piping Work

Refer also to the installation manual for the outdoor unit.

⚠ WARNING

- Do not apply mineral oil on flared part.
- Prevent mineral oil from getting into the system as this would reduce the service life of the units.
- Never use piping which has been used for previous installations. Only use parts which are delivered with the unit.
- Never install a dryer to this R410A unit in order to guarantee its service life.
- The drying material may dissolve and damage the system.
- Incomplete flaring may result in refrigerant gas leakage.

Execute thermal insulation work completely on both sides of the gas and the liquid piping. Otherwise, a water leakage can result sometimes.

For gas piping, use insulation material of which heat resistant temperature is not less than 230°F (110°C).

Also, in cases where the temperature and humidity of the refrigerant piping sections might exceed 86°F (30°C) or RH80%, reinforce the refrigerant insulation. (13/16 inch (20mm) or thicker) Condensation may form on the surface of the insulating material.

Before refrigerant piping work, check which type of refrigerant is used. Proper operation is not possible if the types of refrigerant are not the same.

1. Flaring the pipe end

- 1) Cut the pipe end with a pipe cutter.
- 2) Remove burrs with the cut surface facing downward, so that the filings do not enter the pipe.



- 3) Put the flare nut on the pipe.
- 4) Flare the pipe.
- 5) Check that the flaring has been done correctly.

Flaring

Set exactly at the position shown below.

Flare tool for R32 or R410A	Conventional flare tool		
	Clutch-type	Clutch-type (Rigid-type)	Wing-nut type (Imperial-type)
A	0-0.020 inch (0-0.5mm)	0.039-0.059 inch (1.0-1.5mm)	0.059-0.079 inch (1.5-2.0mm)

Check

The flare's inner surface must be flaw-free.

The pipe end must be evenly flared in a perfect circle.

When flaring, do not over-tighten and crack.

Make sure that the flare nut is fitted.

2. Refrigerant piping

⚠ CAUTION

- Use the flare nut fixed to the main unit. (This is to prevent the flare nut from cracking as a result of deterioration over time.)
- To prevent gas leakage, apply refrigeration oil only to the inner surface of the flare. (Use refrigeration oil for R410A.)
- Use a torque wrench when tightening the flare nuts to prevent damage to the flare nuts and gas leakage.
- Do not have oil adhere to the screw fixing part of resin parts. If oil adheres, it may weaken the strength of screwed part.

- Align the centers of both flares and tighten the flare nuts 3 or 4 turns by hand, then tighten them fully with a spanner and a torque wrench.

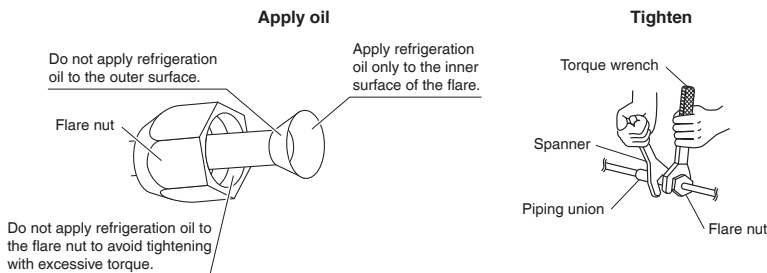

	Piping size	Flare nut tightening torque
Gas side	O.D. 3/8 inch (9.5mm)	24-1/8-29-1/2lbf • ft (32.7-39.9N • m)
	O.D. 1/2 inch (12.7mm)	36-1/2-44-1/2lbf • ft (49.5-60.3N • m)
	O.D. 5/8 inch (15.9mm)	45.6-55.6lbf • ft (61.8-75.4N • m)
Liquid side	O.D. 1/4 inch (6.4mm)	10-1/2-12-3/4lbf • ft (14.2-17.2N • m)

Refrigerant Piping Work

Cautions on piping handling

- Protect the open end of the pipe from dust and moisture.
- All pipe bends should be as gentle as possible. Use a pipe bender for bending.

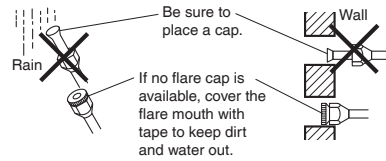

Selection of copper and heat insulation materials

When using commercial copper pipes and fittings, observe the following:

- Insulation material: Polyethylene foam
Heat transfer rate: 0.041 to 0.052W/mK (0.024 to 0.030Btu/ft²h°F (0.035 to 0.045kcal/mh°C))
Be sure to use insulation that is designed for use with HVAC Systems.
- ACR Copper pipe only.

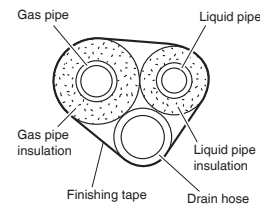

- Be sure to insulate both the gas and liquid piping and observe the insulation dimensions as below.

	Piping size	Minimum bend radius	Piping thickness	Thermal insulation size	Thermal insulation thickness
Gas side	O.D. 3/8 inch (9.5mm)	1-3/16 inch (30mm) or more	0.031 inch (0.8mm) (C1220T-O)	I.D. 15/32-19/32 inch (12-15mm)	13/32 inch (10mm) Min.
	O.D. 1/2 inch (12.7mm)	1-9/16 inch (40mm) or more		I.D. 9/16-5/8 inch (14-16mm)	
	O.D. 5/8 inch (15.9mm)	1-15/16 inch (50mm) or more	0.039 inch (1.0mm) (C1220T-O)	I.D. 5/8-13/16 inch (16-20mm)	
Liquid side	O.D. 1/4 inch (6.4mm)	1-3/16 inch (30mm) or more	0.031 inch (0.8mm) (C1220T-O)	I.D. 5/16-13/32 inch (8-10mm)	

- Use separate thermal insulation pipes for gas and liquid refrigerant pipes.
- Make absolutely sure to execute thermal insulation works on the pipe-connecting section, after checking for gas leakage, by thoroughly studying the following figures and using the included thermal insulating materials (D) fitting insulation and (E) fitting insulation. Fasten both ends with the (H) clamps.
- Make sure to bring the seam of (D) fitting insulation and (E) fitting insulation to the top.

Piping insulation procedure

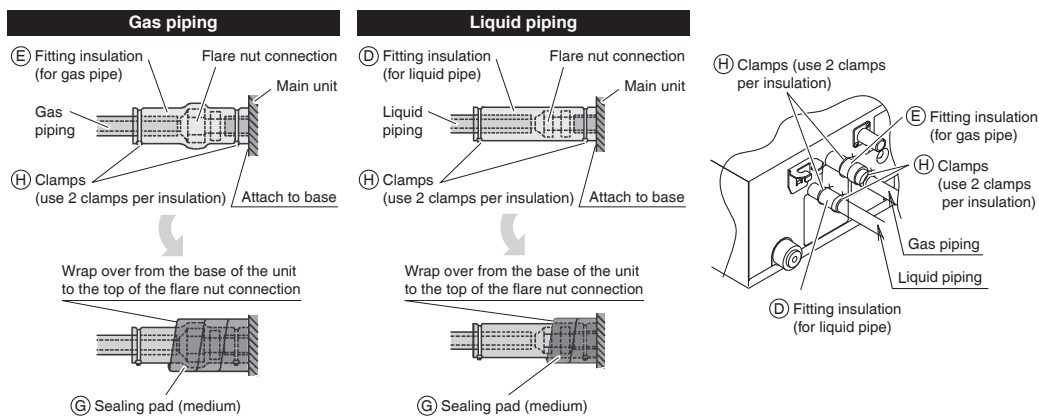

CAUTION

Be sure to insulate any field piping all the way to the piping connection inside the unit. Any exposed piping may cause condensation or burns if touched.

Field Settings

⚠ CAUTION

Before carrying out field setting, check the items mentioned in “2. Test items” (page 21).

- Check if all the installation and piping works for the air conditioner are completed.
- Check that the outside panel and piping cover of the indoor and outdoor units are closed.

After turning on the power supply, carry out field setting from the remote controller according to the installation state.

- The settings shown by in the following tables indicate those when shipped from the factory.
- Carry out setting at 3 places, “Mode No.,” “FIRST CODE No.” and “SECOND CODE No.”.
- The method of setting procedure and operation is shown in the installation manual attached to the remote controller.
- Ask the user to keep the manual attached to the remote controller together with the operation manual.
- Do not carry out settings other than those shown in the table.

NOTE

- Though setting of “Mode No.” is carried out as a group, if you intend to carry out individual setting by each indoor unit or confirmation after setting, carry out setting with the Mode No. shown in the parenthesis ().

1. Setting remote controller

When using wireless remote controllers

- When using the wireless remote controllers, wireless remote controller address setting is necessary. Refer to the installation manual attached to the wireless remote controller.

2. Settings for external static pressure

Make settings in either method (a) or method (b).

(a) Make settings with Air volume automatic adjustment function.

“Air volume automatic adjustment” function: The air volume is adjusted to the rated air volume automatically.

⚠ CAUTION

- Be sure to check that the external static pressure is within the specification range before making settings. The external static pressure will not be automatically adjusted and air volume insufficiency or water leakage may result if the external static pressure is outside the range. (Refer to the technical document for the setting range of external static pressure.)

- 1) Check that the electrical wiring and duct work have been completed.
(If the closing damper is set midway, be sure to check that the damper is opened. Furthermore, check that the air passage on the suction side is provided with an air filter (field supply)).
- 2) If air conditioner has more than one air outlet and air inlet, be sure to make adjustments so that the air volume ratio of each air outlet and the corresponding air inlet will conform to the designed air volume ratio.
In that case, set the operating mode to “Fan”. (In the case of changing the air volume, press the fan speed button on the remote controller and change the current selection to “High”, “Medium”, or “Low”.)
- 3) Make settings to adjust the air volume automatically.
After setting the operating mode to “Fan”, set the air conditioner to field setting mode with the operation of the air conditioner stopped. Select Mode No. [21] (11 in the case of batch settings), select FIRST CODE No. “7”, and set the SECOND CODE No. to “03”.
Return to the “Basic screen” (“Normal mode” if a wireless remote controller is used), and press the ON/OFF button. The operation lamp is lit, and the indoor unit will go into fan operation for air volume automatic adjustments (at which time, do not adjust the opening of the air outlet or inlet). The air volume adjustments will automatically terminate approximately 1 to 15 minutes after the indoor unit comes into operation, and the operation lamp will be OFF and the indoor unit will come to a stop.

Air volume adjustment

Setting content	Mode No.	FIRST CODE No.	SECOND CODE No.
OFF			01
Air volume adjustment completion	11 (21)	7	02
Air volume adjustment start			03

Field Settings

⚠ CAUTION

- If airflow pathway changes, such as duct and air outlet changes, are made after air volume adjustments, be sure to make “Air volume automatic adjustment” again.
- If airflow pathway changes, such as duct and air outlet changes, are made after “Trial Operation and Testing” (page 20) or air conditioner relocation, contact your dealer.

(b) Select external static pressure with the remote controller.

Check with Mode No. [21] per indoor unit that the SECOND CODE No. for the above “Air volume adjustment” is set to “01” (OFF). (The SECOND CODE No. is factory set to “01” (OFF).)
Change the SECOND CODE No. by referring to the table below according to the external static pressure of the duct to be connected.

External static pressure

For 07/09/12 class

Setting content	Mode No.	FIRST CODE NO.	SECOND CODE NO.
0.12 in. WG (30Pa)	13 (23)	6	03
0.16 in. WG (40Pa)			04
0.20 in. WG (50Pa)			05
0.24 in. WG (60Pa)			06
0.28 in. WG (70Pa)			07
0.32 in. WG (80Pa)			08
0.36 in. WG (90Pa)			09
0.40 in. WG (100Pa)			10
0.44 in. WG (110Pa)			11
0.48 in. WG (120Pa)			12
0.52 in. WG (130Pa)			13
0.56 in. WG (140Pa)			14
0.60 in. WG (150Pa)			15

For 15/18/24 class

Setting content	Mode No.	FIRST CODE NO.	SECOND CODE NO.
0.20 in. WG (50Pa)	13 (23)	6	05
0.24 in. WG (60Pa)			06
0.28 in. WG (70Pa)			07
0.32 in. WG (80Pa)			08
0.36 in. WG (90Pa)			09
0.40 in. WG (100Pa)			10
0.44 in. WG (110Pa)			11
0.48 in. WG (120Pa)			12
0.52 in. WG (130Pa)			13
0.56 in. WG (140Pa)			14
0.60 in. WG (150Pa)			15

3. Setting for options

- For settings for options, see the installation manual provided with the option.

4. Setting air filter sign

- Remote controllers are equipped with liquid crystal display air filter signs to display the time to clean air filters.
- Change the SECOND CODE NO. depending on the amount of dirt or dust in the room.

AIR FILTER CLEANING TIME INDICATOR lamp display interval

Setting content	Contamination	Mode No.	FIRST CODE NO.	SECOND CODE NO.
Approx. 2500 hrs	Contamination-light	10 (20)	0	01
Approx. 1250 hrs	Contamination-heavy			02

AIR FILTER CLEANING TIME INDICATOR lamp display

Setting content	Mode No.	FIRST CODE NO.	SECOND CODE NO.
Display ON	10 (20)	3	01
Display OFF*			02

* Use “Display OFF” setting when cleaning indication is not necessary such as the case of periodical cleaning being carried out.

5. When implementing group control

- When using as a pair unit, you may control up to 16 units with the remote controller.
- In this case, all the indoor units in the group will operate in accordance with the group control remote controller.
- Select a remote controller which matches as many of the functions (swing flap, etc.) in the group as possible.

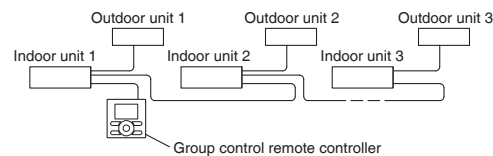

Wiring Method

- 1) Remove the electrical wiring box cover.
(Refer to 1) Remove the electrical wiring box cover in “9. Wiring” on page 12.)
- 2) Cross-wire the terminal block for remote controller (P1, P2) inside the electrical wiring box. (There is no polarity.)
(Refer to 3. Specification for field wire in “9. Wiring” on page 12)

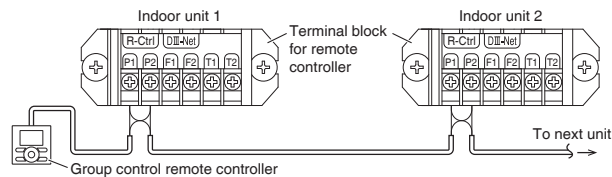

Trial Operation and Testing

After finishing the construction of refrigerant piping, drain piping, and electric wiring, conduct trial operation accordingly to protect the unit.

1. Trial operation and testing

⚠ CAUTION

After test operation is completed, check the items mentioned “Items to be checked at time of delivery” (page 22).
If the interior finish work is not completed when the test operation is finished, for protection of the air conditioner, ask the user not operate the air conditioner until the interior finish work is completed.
If the air conditioner is operated, the inside of the indoor units may be polluted by substances generated from the coating and adhesives used for the interior finish work and cause water splash and leakage.

Trial operation should be carried out in either COOL or HEAT operation.

1-1. Measure the supply voltage and make sure that it is within the specified range.

1-2. In COOL operation, select the lowest programmable temperature; in HEAT operation, select the highest programmable temperature.

1-3. Carry out the trial operation following the instructions in the operation manual to ensure that all functions and parts, such as the movement of the louvers, are working properly.

- To protect the air conditioner, restart operation is disabled for 3 minutes after the system has been turned off.

1-4. After trial operation is complete, set the temperature to a normal level (78°F to 82°F (26°C to 28°C) in COOL operation, 68°F to 75°F (20°C to 24°C) in HEAT operation).

- When operating the air conditioner in COOL operation in winter, or HEAT operation in summer, set it to the trial operation mode using the following method.

Refer to **For wired remote controller**.

Refer to **For wireless remote controller** (page 21).

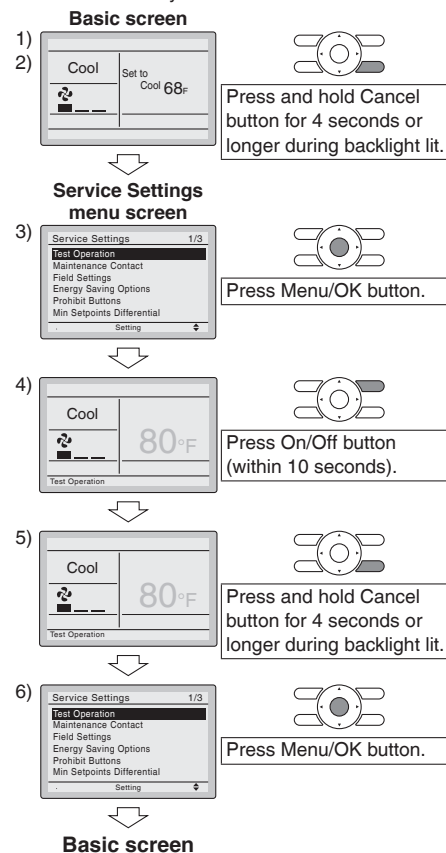

For wired remote controller

- Set to COOL or HEAT operation using the remote controller.
- Press and hold Cancel button for 4 seconds or longer. Service settings menu is displayed.
- Select **Test Operation** in the service settings menu, and press Menu/OK button. Basic screen returns and “Test Operation” is displayed at the bottom.
- Press On/Off button within 10 seconds, and the test operation starts.
Monitor the operation of the indoor unit for a minimum of 10 minutes. During test operation, the indoor unit will continue to cool/heat regardless of the temperature setpoint and room temperature.
 - In the case of above-mentioned procedures 3) and 4) in reverse order, test operation can start as well.
- Press and hold Cancel button for 4 seconds or longer in the basic screen. Service settings menu is displayed.
- Select **Test Operation** in the service settings menu, and press Menu/OK button. Basic screen returns and normal operation is conducted.
 - Test operation will stop automatically after 15-30 minutes. To stop the operation, press On/Off button.



Trial Operation and Testing

For wireless remote controller

- 1) Press  and select the COOL or HEAT operation.
- 2) Press  twice. "Test" is displayed.
- 3) Press  within 10 seconds, and the test operation starts.

Monitor the operation of the indoor unit for a minimum of 10 minutes.

During test operation, the indoor unit will continue to cool/heat regardless of the temperature setpoint and room temperature.

- In the case of above-mentioned procedures 1) and 2) in reverse order, test operation can start as well.
- Test operation will stop automatically after 15 - 30 minutes.

To stop the operation, press .

- Some of the functions cannot be used in the test operation mode.

Precautions

Refer to "3. How to diagnose for malfunction" (page 23) if the unit does not operate properly.

2. Test items



Test items	Symptom	Check
Indoor and outdoor units are installed securely.	Fall, vibration, noise	
No refrigerant gas leaks.	Incomplete cooling/heating function	
Refrigerant gas and liquid pipes and indoor drain hose extension are thermally insulated.	Water leakage	
Draining line is properly installed.	Water leakage	
The power supply voltage corresponds to that shown on the name plate.	No operation or burn damage	
System is properly grounded.	Electrical leakage	
Only specified wires are used for all wiring, and all wires are connected correctly.	No operation or burn damage	
Indoor or outdoor unit's air inlet or air outlet are unobstructed.	Incomplete cooling/heating function	
Refrigerant piping length and additional refrigerant charge are noted down.	The refrigerant charge in the system is not clear	
Pipes and wires are connected to the corresponding connection ports / terminal blocks for the connected unit.	No cooling/heating	
Stop valves are opened.	Incomplete cooling/heating function	
Indoor unit properly receives wireless remote control commands.	No operation	
The external static pressure is set correctly.	Incomplete cooling/heating function or water leakage	

Items to be checked at time of delivery

Also review the “Precautions” (page 3)

Test items	Check
The electrical wiring box cover and air filter are attached.	
I explained about operations while showing the operation manual to the user.	
Field setting has been carried out. (if necessary)	
It has been confirmed that the cool air discharges during the COOL operation and the warm air discharges during the HEAT operation. The indoor unit does not make unpleasant sounds of air discharge.	
I explained the set fan speed to the user (if the fan speed was set at thermostat OFF).	
I handed the operation manual over to the user.	
I have checked that there is no generation of abnormal noise (i.e., noise resulting from contamination or missing parts).	
The printed circuit board switch is not on the emergency (EMG.) side. The switch is factory set to the normal (NORM.) side.	
I have checked the operation of the optional accessory and made field settings as needed (if an optional accessory is in use).	
I have explained failure examples of “3.How to diagnose for malfunction” (page 23).	
I explained the power supply status (power supply ON/OFF) to the user.	

Points for explanation about operations

The items with  WARNING and  CAUTION marks in the operation manual are the items pertaining to possibilities for bodily injury and material damage in addition to the general usage of the product. Accordingly, it is necessary that you make a full explanation about the described contents and also ask your user to read the operation manual.

Note to the installer

Be sure to instruct user how to properly operate the unit (especially cleaning the filter, operating different functions, and adjusting the temperature) by having them carry out operations while looking at the manual.

 To the operator carrying out test operation _____

After test operation is completed, before delivering the air conditioner to the user, confirm that the electrical wiring box cover is closed.

In addition, explain the power supply status (power supply ON/OFF) to the user.

Trial Operation and Testing

3. How to diagnose for malfunction

- If the air conditioner does not operate normally after installing the air conditioner, a malfunction shown in the table below may happen.

Wired remote controller display	Description
No display	<ul style="list-style-type: none"> • Power outage, power voltage error or open-phase • Incorrect wiring (between indoor and outdoor units) • Indoor PC-board assembly failure • Remote controller wiring not connected • Remote controller failure • Open fuse or tripped circuit breaker (outdoor unit)
"Checking the connection. Please stand by:"*	<ul style="list-style-type: none"> • Indoor PC-board assembly failure • Wrong wiring (between indoor and outdoor units)

* "Checking the connection. Please stand by" will be displayed for up to 90 seconds following the application of power to the indoor unit. This is normal and does not indicate a malfunction.

- Diagnose with the display on the liquid crystal display remote controller.

With the wired remote controller

When the operation stops due to a malfunction, operation lamp blinks, and the malfunction code is indicated on the liquid crystal display. In such a case, diagnose the fault contents by referring to **Error History** in the service settings menu. In the case of group control, the unit No. is displayed so that the indoor unit with the trouble can be identified.

With the wireless remote controller

(Refer also to the operation manual attached to the wireless remote controller)

When the operation stops due to a malfunction the display on the indoor unit blinks. In such a case, diagnose the fault contents with the error code which can be found by following procedures.

- 1) Press the INSPECTION/TEST OPERATION button, "👁" is displayed and "0" blinks.
- 2) Press the TEMPERATURE SETTING button and find the unit No. which stopped due to trouble.

Number of beeps	3 short beeps.....	Perform all the following operations
	1 short beep	Perform (3) and (6)
	1 long beep.....	No trouble
- 3) Press the OPERATION MODE SELECTOR button and upper figure of the error code blinks.
- 4) Continue pressing the TEMPERATURE SETTING button until it makes 2 short beeps and find the upper code.
- 5) Press the OPERATION MODE SELECTOR button and lower figure of the error code blinks.
- 6) Continue pressing the TEMPERATURE SETTING button until it makes a long beep and find the lower code.
 - A long beep indicate the error code.

4. Malfunction code

- For places where the malfunction code is written in white, the "👁" indication is not displayed. Though the system continues operating, be sure to inspect the system and make repairs as necessary.
- Depending on the type of indoor or outdoor unit, the malfunction code may or may not be displayed.

Malfunction code	Descriptions and measures	Remarks
A1	Indoor Printed Circuit Board failure	
A3	Drain level abnormal	
A5	High pressure control or freeze-up protector	
A6	Indoor fan motor overload, over current, lock	
	Indoor Printed Circuit Board connection failure	
A8	Indoor unit power supply voltage abnormal	
AJ	Capacity setting failure	Capacity setting adapter or capacity data error, or disconnection of the capacity setting adapter, failure to connect the adapter, or the capacity is not set to the data-retention IC.

Malfunction code	Descriptions and measures	Remarks
C1	Transmission error between indoor Printed Circuit Board (Master) and indoor Printed Circuit Board (Slave)	
C4	Indoor heat exchanger liquid pipe temperature sensor malfunction	Abnormal stop is applied depending on the model or condition.
C5	Indoor heat exchanger condenser / evaporator temperature sensor malfunction	Abnormal stop is applied depending on the model or condition.
C9	Suction air thermistor malfunction	Abnormal stop is applied depending on the model or condition.
CJ	Remote controller air thermistor malfunction	Remote controller thermo does not function, but body thermo operation is enabled.
E0	Action of safety device (Outdoor unit)	
E1	Outdoor Printed Circuit Board failure (Outdoor unit)	
E3	High pressure switch (HPS) activated	Depending on the type of outdoor unit connected, the malfunction code may not be displayed.
E5	OL (compressor overload) started, high pressure switch (HPS) activated	Depending on the type of outdoor unit connected, the malfunction contents may be different.
E6	Compressor motor lock by over current (Outdoor unit)	
E7	Outdoor fan motor lock malfunction (Outdoor unit) Outdoor fan instant overcurrent malfunction (Outdoor unit)	
E8	Input overcurrent (Outdoor unit)	
EA	Cooling/heating switch malfunction (Outdoor unit)	
F3	Discharge piping temperature malfunction (Outdoor unit)	
F6	High pressure control (in cooling) (Outdoor unit)	
F8	Operation halt due to compressor internal temperature abnormality	
H0	Sensor fault for inverter (Outdoor unit)	
H6	Operation halt due to faulty position detection sensor	
H8	CT abnormality (Outdoor unit)	
H9	Outdoor air thermistor system malfunction (Outdoor unit)	Abnormal stop is applied depending on the model or condition.
J3	Discharge piping thermistor system malfunction (Outdoor unit)	Abnormal stop is applied depending on the model or condition.
J6	Outdoor heat exchanger distributor liquid piping thermistor malfunction (Outdoor unit)	Abnormal stop is applied depending on the model or condition.
L3	Reactor thermistor malfunction (Outdoor unit)	
L4	Overheated heat-radiating fin (Outdoor unit)	Inverter cooling failure.
L5	Instantaneous overcurrent (Outdoor unit)	The compressor engines and turbines may be experiencing a ground fault or short circuit.
P4	Heat-radiating fin thermistor malfunction (Outdoor unit)	Abnormal stop is applied depending on the model or condition.
U0	Suction piping temperature abnormal (Outdoor unit)	The refrigerant may be insufficient. Abnormal stop is applied depending on the model or condition.
U2	Power voltage malfunction (Outdoor unit)	The inverter open-phase or main circuit condenser may be malfunctioning. Abnormal stop is applied depending on the model or condition.
U4 UF	Transmission error (between indoor and outdoor units)	Wiring error between indoor and outdoor unit. Or Indoor and outdoor Printed Circuit Board failure.
U5	Transmission error (between indoor and remote controller units)	Transmission between indoor unit and remote controller is not performed properly.
U7	Transmission error of the inverter module	
UA	Field setting error	System setting error of the simultaneous on/off multi-split type.
UE	Transmission error (between indoor unit and centralized remote controller)	
UC	Remote controller address setting error	

1.6 FFQ

Contents

Safety Considerations	1	Refrigerant Piping Work	14
Before Installation	3	1. Flaring the pipe end.....	14
Accessories	3	2. Refrigerant piping	14
Choosing an Installation Site	4	Installation of the Decoration Panel	15
Indoor Unit Installation	6	Field Settings	16
1. Relation of ceiling opening to unit and suspension bolt position	6	1. Setting air outlet direction	16
2. Make the ceiling opening needed for installation where applicable (For existing ceilings).....	7	2. Setting for options.....	16
3. Installing the suspension bolts	7	3. Setting remote controller	16
4. Installing the indoor unit	7	4. Setting air filter sign	16
5. Drain piping work.....	8	5. When implementing group control.....	16
6. Wiring	11	6. 2 remote controllers (controlling 1 indoor unit by 2 remote controllers).....	17
		Trial Operation and Testing	17
		1. Trial operation and testing	17
		2. Test items	19
		3. How to diagnose for malfunction	20

The pictures in this document are for illustrative purposes only.

Safety Considerations

Refer also to the General Safety Considerations in the separate booklet.





Read the precautions in this manual carefully before operating the unit.

Read these **Safety Considerations for Installation** carefully before installing an air conditioner or heat pump. After completing the installation, make sure that the unit operates properly during the startup operation.

Instruct the user on how to operate and maintain the unit. Inform users that they should store this installation manual with the operation manual for future reference.

Always use a licensed installer or contractor to install this product. Improper installation can result in water or refrigerant leakage, electric shock, fire, or explosion.

Meanings of **DANGER**, **WARNING**, **CAUTION**, and **NOTE** Symbols:

-  **DANGER**
-  **WARNING**
-  **CAUTION**
-  **NOTE**

 **DANGER** _____

- Refrigerant gas is heavier than air and replaces oxygen. A massive leak can lead to oxygen depletion, especially in basements, and an asphyxiation hazard could occur leading to serious injury or death.
- Do not ground units to water pipes, gas pipes, telephone wires, or lightning rods as incomplete grounding can cause a severe shock hazard resulting in severe injury or death. Additionally, grounding to gas pipes could cause a gas leak and potential explosion causing severe injury or death.

- If refrigerant gas leaks during installation, ventilate the area immediately. Refrigerant gas may produce toxic gas if it comes into contact with fire. Exposure to this gas could cause severe injury or death.
- After completing the installation work, check that the refrigerant gas does not leak throughout the system.
- Do not install unit in an area where flammable materials are present due to risk of explosions that can cause serious injury or death.
- Safely dispose all packing and transportation materials in accordance with federal/state/local laws or ordinances. Packing materials such as nails and other metal or wood parts, including plastic packing materials used for transportation may cause injuries or death by suffocation.

 **WARNING** _____

- Only qualified personnel licensed or certified in their jurisdiction must carry out the installation work. Installation must be done in accordance with this installation manual. Improper installation may result in water leakage, electric shock, or fire.
- When installing the unit in a small room, take measures to keep the refrigerant concentration from exceeding allowable safety limits. Excessive refrigerant leaks, in the event of an accident in a closed ambient space, can lead to oxygen deficiency.
- Use only specified accessories and parts for installation work. Failure to use specified parts may result in water leakage, electric shock, fire, or the unit falling.
- Install the air conditioner or heat pump on a foundation strong enough that it can withstand the weight of the unit. A foundation of insufficient strength may result in the unit falling and causing injuries.
- Take into account strong winds, typhoons, or earthquakes when installing. Improper installation may result in the unit falling and causing accidents.
- Make sure that a separate power supply circuit is provided for this unit and that all electrical work is carried out by qualified personnel licensed or certified in their jurisdiction according to local, state, and national regulations. An insufficient power supply capacity or improper electrical construction may lead to electric shock or fire.
- Make sure that all wiring is secured, that specified wires are used, and that no external forces act on the terminal connections or wires. Improper connections or installation may result in fire.

- When wiring, position the wires so that the electrical wiring box cover can be securely fastened. Improper positioning of the electrical wiring box cover may result in electric shock, fire, or the terminals overheating.
- Before touching electrical parts, turn off the unit.
- The circuit must be protected with safety devices in accordance with local and national codes, i.e. a circuit breaker.
- Securely fasten the outdoor unit terminal cover (panel). If the terminal cover/panel is not installed properly, dust or water may enter the outdoor unit causing fire or electric shock.
- When installing or relocating the system, keep the refrigerant circuit free from substances other than the specified refrigerant (R410A) such as air. Any presence of air or other foreign substance in the refrigerant circuit can cause an abnormal pressure rise or rupture, resulting in equipment damage and even injury.
- Do not change the setting of the protection devices. If the pressure switch, thermal switch, or other protection device is shorted and operated forcibly, or parts other than those specified by Daikin are used, fire or explosion may occur.
- Do not use means to accelerate the defrosting process (if possible) or to clean, other than those recommended by the manufacturer.
- The appliance must be stored in a room without continuously operating ignition sources (for example: open flames, an operating gas appliance or an operating electric heater).
- Do not pierce or burn.
- Be aware that refrigerants may not contain an odor.
- Comply with national gas regulations.

CAUTION

- Do not touch the switch with wet fingers. Touching a switch with wet fingers can cause electric shock.
- Do not allow children to play on or around the unit to prevent injury.
- Wear adequate personal protective equipment (protective gloves, safety glasses,...) when installing, maintaining or servicing the system.
- The heat exchanger fins are sharp enough to cut. To avoid injury, wear gloves or cover the fins while working around them.
- Do not touch the refrigerant pipes during and immediately after operation as the refrigerant pipes may be hot or cold, depending on the condition of the refrigerant flowing through the refrigerant piping, compressor, and other refrigerant cycle parts. Your hands may suffer burns or frostbite if you touch the refrigerant pipes. To avoid injury, give the pipes time to return to normal temperature or, if you must touch them, be sure to wear proper gloves.
- Install drain piping to ensure proper drainage. Improper drain piping may result in water leakage and property damage.
- Insulate piping to prevent condensation.
- Be careful when transporting the product.
- Do not turn off the power immediately after stopping operation. Always wait for at least 5 minutes before turning off the power. Otherwise, water leakage may occur.
- Do not use a charging cylinder. Using a charging cylinder may cause the refrigerant to deteriorate.
- Refrigerant R410A in the system must be kept clean, dry, and tight.

- (a) Clean and Dry -- Foreign materials (including mineral oils such as SUNISO oil or moisture) should be prevented from getting into the system.

- (b) Tight -- R410A does not contain any chlorine, does not destroy the ozone layer, and does not reduce the earth's protection against harmful ultraviolet radiation. R410A can contribute to the greenhouse effect if it is released. Therefore take proper measures to check for the tightness of the refrigerant piping installation. Read the chapter *Refrigerant Piping Work* and follow the procedures.
- Since R410A is a blend, the required additional refrigerant must be charged in its liquid state. If the refrigerant is charged in a state of gas, its composition can change and the system will not work properly.
- The indoor unit is for R410A. See the catalog for outdoor models that can be connected. Normal operation is not possible when connected to non-compatible outdoor units.
- Remote controller (wireless kit) transmitting distance can be shorter than expected in rooms with electronic fluorescent lamps (inverter or rapid start types). Install the indoor unit far away from fluorescent lamps as much as possible.
- Indoor units are for indoor installation only. Outdoor units can be installed either outdoors or indoors.
- Do not install the air conditioner or heat pump in the following locations:
 - (a) Where a mineral oil mist or oil spray or vapor is produced, for example, in a kitchen. Plastic parts may deteriorate and fall off or result in water leakage.
 - (b) Where corrosive gas, such as sulfurous acid gas, is produced. Corroding copper pipes or soldered parts may result in refrigerant leakage.
 - (c) Near machinery emitting electromagnetic waves. Electromagnetic waves may disturb the operation of the control system and cause the unit to malfunction.
 - (d) Where flammable gas may leak, where there is carbon fiber, or ignitable dust suspension in the air, or where volatile flammables such as thinner or gasoline are handled. Operating the unit in such conditions can cause a fire.
- Take adequate measures to prevent the outdoor unit from being used as a shelter by small animals. Small animals making contact with electrical parts can cause malfunctions, smoke, or fire. Instruct the user to keep the area around the unit clean.
- Servicing shall be performed only as recommended by the manufacturer and licensed or certified in their jurisdiction.

NOTE

- The indoor unit should be positioned where the unit and inter-unit wires (outdoor to indoor) are at least 3.3ft (1m) away from any televisions or radios. (The unit may cause interference with the picture or sound.) Depending on the radio waves, a distance of 3.3ft (1m) may not be sufficient to eliminate the noise.
- Dismantling the unit, treatment of the refrigerant, oil and additional parts must be done in accordance with the relevant local, state, and national regulations.
- Only use tools for R410A, such as a gauge manifold, charge hose, gas leak detector, reverse flow check valve, refrigerant charge base, vacuum gauge, or refrigerant recovery equipment.
- If the conventional refrigerant and refrigerator oil are mixed in R410A, the refrigerant may deteriorate.
- This air conditioner or heat pump is an appliance that should not be accessible to the general public.
- As maximum allowable pressure is 604psi (4.17MPa), the wall thickness of field-installed pipes should be selected in accordance with the relevant local, state, and national regulations.

FTN005-U













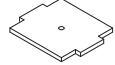

Before Installation

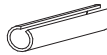
- Leave the unit inside its packaging until you reach the installation site. Where unpacking is unavoidable, use a sling of soft material or protective plates together with a rope when lifting, this to avoid damage or scratches to the unit.
When unpacking the unit or when moving the unit after unpacking, be sure to lift the unit by holding on to the hanger bracket without exerting any pressure on other parts, especially on refrigerant piping, drain piping and other resin parts.
- Refer to the installation manual of the outdoor unit for items not described in this manual.
- Caution concerning refrigerant series R410A:
The connectable outdoor units must be designed exclusively for R410A.

Precautions

- Do not install or operate the unit in places mentioned below.
 - Places with mineral oil, or filled with oil vapor or spray like in kitchens. (Plastic parts may deteriorate.)
 - Where corrosive gas like sulphurous gas exists. (Copper tubing and brazed spots may corrode.)
 - Where volatile flammable gas like thinner or gasoline is used.
 - Where machines generating electromagnetic waves exist. (Control system may malfunction.)
 - Where the air contains high levels of salt such as near the ocean and where voltage fluctuates a lot (e.g. in factories). Also inside vehicles or vessels.
- When selecting the installation site, use the supplied (E) template for installation.
- Do not install accessories on the casing directly. Drilling holes in the casing may damage electrical wires and consequently cause fire.
- Take off static electricity from the body when carrying out wiring and the electrical wiring box cover is removed.
The electric parts may be damaged.

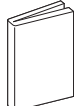
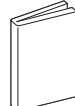
Accessories

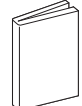
(A) Drain hose 	1	(B) Clamp metal 	1	(C) Washer for hanger bracket 	8	(D) Clamp 	7
(E) Template (cut out from upper part of packing) 	1	(F) Screws (M5) (for template) 	4	(G) Fitting insulation (for gas pipe) 	1	(H) Fitting insulation (for liquid pipe) 	1
(J) Sealing pad (large) 	1	(K) Sealing pad (medium A) 	1	(L) Sealing pad (medium B) 	1	(M) Sealing pad (small) 	1
(N) Washer for conduit 	1	(P) Operation manual 	1	(Q) Installation manual 	1	(R) Warranty 	1
(S) General safety considerations 	1						

Optional Accessories

- The optional decoration panel and remote controller are required for this indoor unit.

Table 1

Optional decoration panel		
Type A	BYFQ60B3W1	Color: White
Type B	BYFQ60C2W1W	Color: White
Type B	BYFQ60C2W1S	Color: Silver

- There are 2 types of remote controllers: wired and wireless. Select a remote controller from Table 2 according to customer request and install in an appropriate place.

Table 2

Remote controller type	Model name
Wired type	BRC1E73
Wireless type	BRC082A41W / BRC082A42W / BRC082A42S

- If you wish to use a remote controller that is not listed in Table 2, select a suitable remote controller after consulting catalogs and technical materials.

Choosing an Installation Site

Hold the unit by the 4 hanger brackets when opening the box and moving it, and do not exert pressure on to any other part, piping (refrigerant, drain, etc.), or plastic parts.

If the temperature or humidity inside the ceiling might rise above 86°F (30°C) or RH 80%, respectively, add extra insulation to the unit.

Use polyethylene foam as insulation and make sure it is at least 3/8 inch (10mm) thick and fits inside the ceiling opening.

Select the air flow directions best suited to the room and point of installation.

For air discharge in 3 directions, it is necessary to make field settings by means of the remote controller and to close the air outlet (s).

Refer to the installation manual of the blocking pad kit (sold separately) and to “Field Settings” on page 16.

- Before choosing the installation site, obtain user approval.
 - The indoor unit should be positioned in a place where:
 - both the air inlet and air outlet are unobstructed,
 - the unit is not exposed to direct sunlight,
 - the unit is away from the source of heat or steam,
 - there is no source of machine oil vapor (this may shorten the indoor unit service life),
 - cool/warm air is circulated throughout the room,
 - the unit is away from electronic ignition type fluorescent lamps (inverter or rapid start type) as they may affect the remote controller range,
 - no laundry equipment is nearby,
 - drainage can be performed without any problem,
 - the weight of the indoor unit can be adequately supported,
 - the wall and the ceiling's lower surface are not significantly tilted,
 - room can be left for installation and service work,
 - there is no risk of flammable gas leaking,
 - the required length of indoor-outdoor piping would not exceed the specified maximum length (see the installation manual that came with the outdoor unit for details).

Choosing an Installation Site

Installation Space Requirements

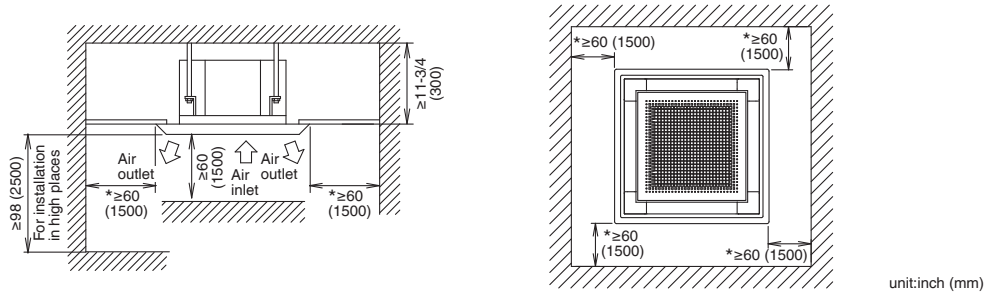

- Leave 8 inch (200mm) or more space where marked with the *, on sides where the air outlet is closed.

<Failure example>

If there is an obstacle in the airflow path or proper installation space is not provided, the indoor unit will cause air volume reduction and take in air blown out of the indoor unit, thus resulting in performance degradation or turning the thermostat OFF frequently.

Air flow direction

- The air direction shown is an example.
- Select the appropriate number of directions according to the shape of the room and the location of the unit. (Field settings have to be made using the remote controller and the outlet vents have to be shut off if 2 or 3 directions are selected. See the blocking pad kit (sold separately) installation manual for details.)

Air flow direction (Example)

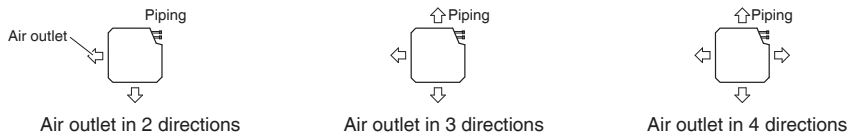

Use suspension bolts for installation. Check whether the ceiling is strong enough to support the weight of the unit or not. If there is a risk, reinforce the ceiling before installing the unit.

(Installation pitch is marked on the (E) template. Refer to it to check for points requiring reinforcing.)

Indoor Unit Installation

1. Relation of ceiling opening to unit and suspension bolt position

For decoration panel type A

Top view

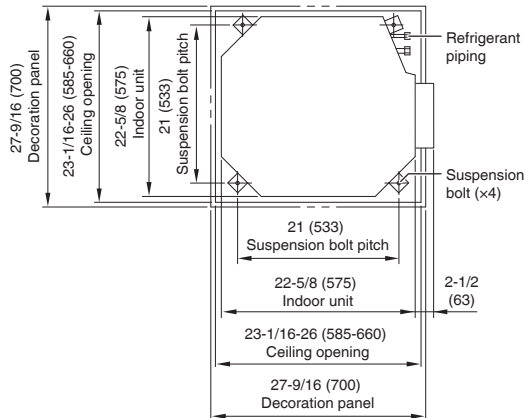

For decoration panel type B

Top view

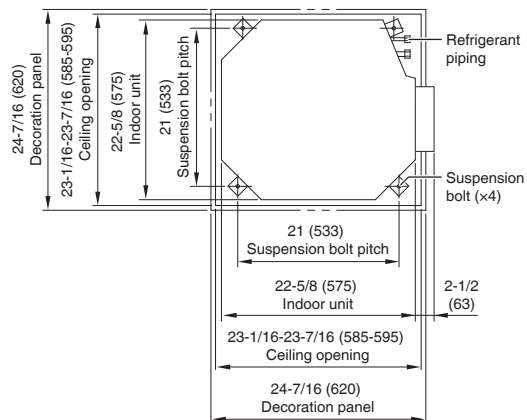

Side view

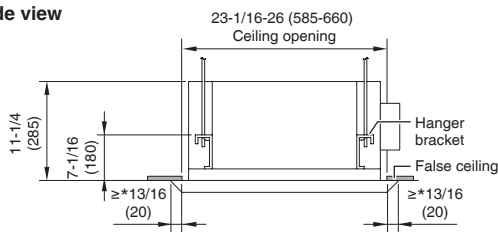

Side view

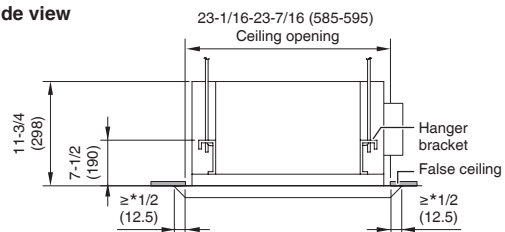

unit: inch (mm)

NOTE

- *If the panel does not extend over the ceiling by this amount, supplement with extra ceiling material or restore the ceiling.
- Install the inspection opening on the electrical wiring box side where maintenance and inspection of the electrical wiring box and drain pump are easy.

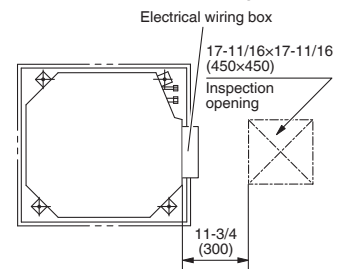

Indoor Unit Installation

2. Make the ceiling opening needed for installation where applicable (For existing ceilings)

- Refer to the (E) template for ceiling opening dimensions.
- Create the ceiling opening required for installation. From the side of the opening to the casing outlet, implement the refrigerant and drain piping and wiring for remote controller (unnecessary for wireless type) and wiring between units. Refer to each Drain piping work or Wiring section.
- After making an opening in the ceiling, it may be necessary to reinforce ceiling beams to keep the ceiling level and to prevent it from vibrating. Consult the builder for details.

3. Installing the suspension bolts

(Use either a M8-M10 size bolt or the equivalent)

Use a hole-in anchor for existing ceilings, and a sunken insert, sunken anchor or other field supplied parts for new ceilings to reinforce the ceiling to bear the weight of the unit. Adjust clearance (2-4 inch (50-100mm)) from the ceiling before proceeding further.

- All the above parts are field supplied.

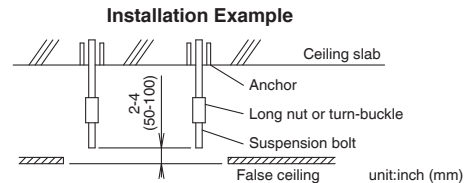

4. Installing the indoor unit

When installing optional accessories (except for the decoration panel), read also the installation manual of the optional accessories. Depending on the field conditions, it may be easier to install optional accessories before the indoor unit is installed. However, for existing ceilings, always install fresh air intake kit before installing the unit.

As for the parts to be used for installation work, be sure to use the provided accessories and specified parts designated by Daikin.

For new ceilings

- 1) Install the indoor unit temporarily.
 - Attach the hanger bracket to the suspension bolt. Be sure to fix it securely by using a nut and (C) washer from the upper and lower sides of the hanger bracket.

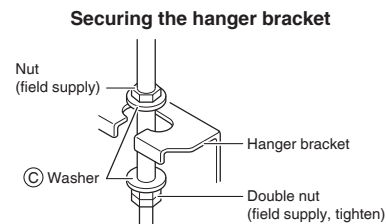

- 2) Refer to the (E) template for ceiling opening dimension. Consult the builder or carpenter for details.
 - The center of the ceiling opening is indicated on the (E) template. This indication also indicates the center of the unit.
 - The (E) template can be rotated by 90° to be able to indicate the correct dimensions on all 4 sides.
 - After cutting the template from the packaging, attach the (E) template to the unit with (F) screws (x4) as shown in figure.
 - Ceiling height is shown on the side of the (E) template. Adjust the height of the unit according to this indication.

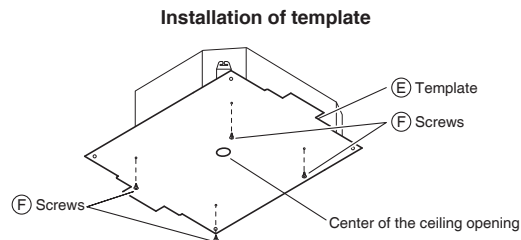

Ceiling work

- 3) Adjust the unit to the right position for installation.

(Refer to 1. Relation of ceiling opening to unit and suspension bolt position.)

⚠ CAUTION

If the unit is tilted against condensate flow, the float switch may malfunction and cause water to drip.

- 4) Check the unit is horizontally level.
 - The indoor unit is equipped with a built-in drain pump and float switch. Verify that it is level by using a water level or a water-filled vinyl tube.
- 5) Remove the (E) template.

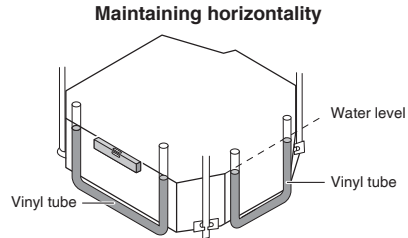

For existing ceilings

- 1) Install the indoor unit temporarily.
 - Attach the hanger bracket to the suspension bolt. Be sure to fix it securely by using a nut and (C) washer from the upper and lower sides of hanger bracket.

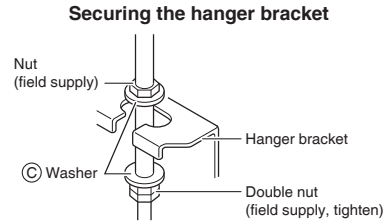

- 2) Adjust the height and position of the unit.
(Refer to 1. Relation of ceiling opening to unit and suspension bolt position.)
- 3) Perform steps 4) in **For new ceilings**.

5. Drain piping work

⚠ CAUTION

- Water pooling in the drainage piping can cause the drain to clog.
- **Do not connect the drain piping directly to sewage pipes that smell of ammonia. The ammonia in the sewage might enter the indoor unit through the drain pipes and corrode the heat exchanger.**
- **Keep in mind that the drain pipe becomes blocked if water collects on it.**

1. Install of drain piping

- Install the drain piping as shown in the figure and take measures against condensation. Improperly rigged piping could lead to leaks and eventually wet furniture and belongings.
- Keep piping as short as possible and slope it downwards at a gradient of at least 1/100 so that air may not remain trapped inside the pipe.
- Keep pipe size equal to or greater than that of the connecting pipe (vinyl pipe of nominal diameter 13/16 inch (20mm) and outer diameter 1 inch (26mm)).
- Push the supplied drain hose as far as possible over the drain socket.
- If the drain hose cannot be sufficiently set on a slope, refer to **“Precautions for drain raising piping”**.
- To keep the drain hose from sagging, space hanger bracket every 40-60 inch (1000-1500mm).

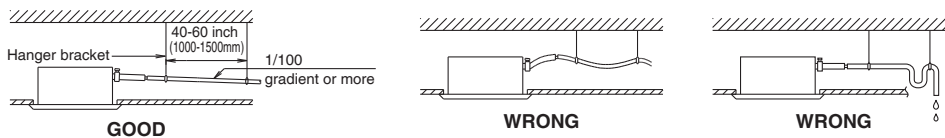

Indoor Unit Installation

- Tighten the (B) clamp metal as indicated in the illustration.
- After the testing of drain piping is finished, attach the drain (J) sealing pad (large) supplied with the unit over the uncovered part of the drain socket (= between drain hose and unit body).
- Wrap the supplied large sealing pad over the (B) clamp metal and (A) drain hose to insulate and fix it with clamps.
- Insulate the complete drain piping inside the building (field supply).
- If the drain hose cannot be sufficiently set on a slope, fit the hose with drain raising piping (field supply).

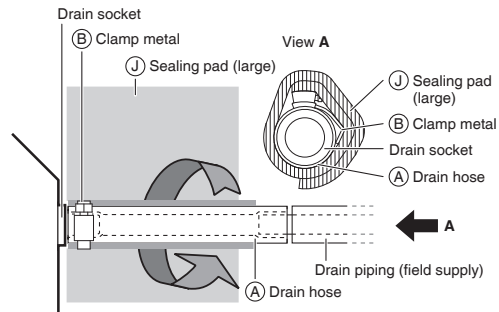

Precautions for drain raising piping

- Install the drain raising pipes at a height of less than H2.
- Install the drain raising pipes at a right angle to the indoor unit and no more than 11-3/4 inch (300mm) from the unit.

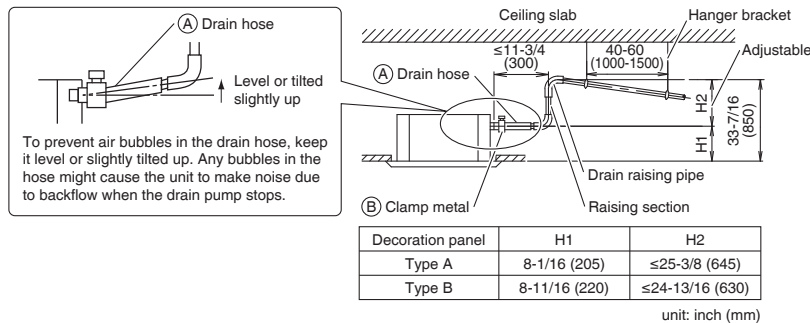

To prevent air bubbles in the drain hose, keep it level or slightly tilted up. Any bubbles in the hose might cause the unit to make noise due to backflow when the drain pump stops.

- To ensure no excessive pressure is applied to the included (A) drain hose, do not bend or twist the hose when installing as it could cause leakage.
- If converging multiple drain pipes, install according to the procedure shown below.

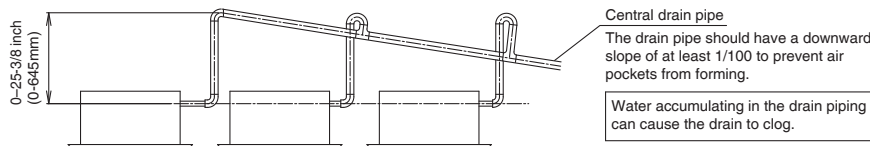

Select converging drain pipes with gauges is suitable for the operating capacity of the unit.

2. After piping work is finished, check if drainage flows smoothly

- Add approximately 1/4 gal of water slowly from the air outlet and check drainage flow.

Method of adding water

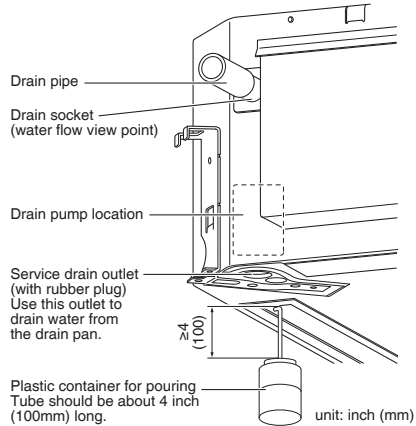

When electric wiring work is finished

- Check drainage flow during COOL operation, explained in “**Trial operation and testing**” on page 17.

When electric wiring work is not finished

⚠ CAUTION

Electrical wiring work should be done by a certified electrician.

- If someone who does not have the proper qualifications performs the work, perform the following actions after the trial operation is complete.
 - 1) Remove the electrical wiring box cover (2 screws). Connect the single phase power supply (SINGLE PHASE 60 Hz 208/230V) to connections No.1 and No.2 on the terminal block for power supply. Do not connect to No.3 of the terminal block for power supply or the drain pump will not operate. When carrying out wiring work around the electrical wiring box, make sure none of the connectors come undone. Be sure to attach the electrical wiring box cover before turning on the power.
 - 2) After confirming drainage, turn off the power supply and remove the power supply wiring.
 - 3) Attach the electrical wiring box cover as before.

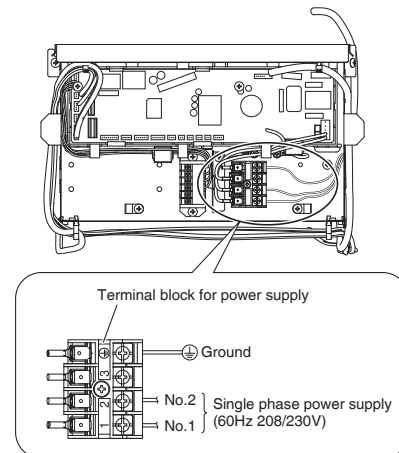
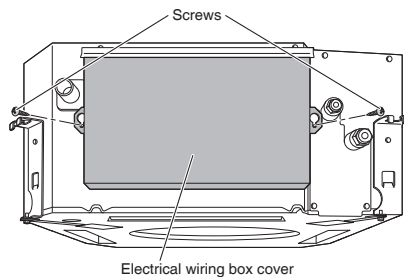

Indoor Unit Installation

6. Wiring

Refer also to the installation manual for the outdoor unit.



WARNING

- Do not use tapped wires, extension cords, or starburst connections, as they may cause overheating, electric shock, or fire.
- Do not use locally purchased electrical parts inside the product. (Do not branch the power for the drain pump, etc., from the terminal block.) Doing so may cause electric shock or fire.
- Do not connect the power wire to the indoor unit. Doing so may cause electric shock or fire.



CAUTION

Recommend stranded cable for interunit wiring. Local code always supersedes recommendation.

- For stranded wires, make sure to use the round crimp-style terminal for connection to the power supply terminal block. Place the round crimp-style terminals on the wires up to the covered part and secure in place.

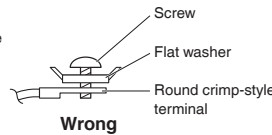
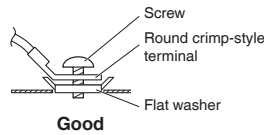
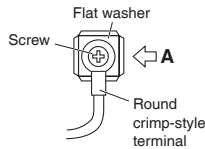
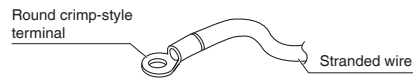

Arrow view A

- If solid core wire must be used, be sure to curl the end of the lead. Improper work may cause heat and fire.

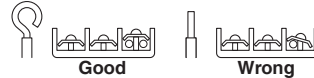

- When clamping wiring, use the included clamping material to prevent outside pressure being exerted on the wiring connections and clamp firmly. When doing the wiring, make sure the wiring is neat and does not cause the electrical wiring box cover to stick up, then close the cover firmly.
- Outside the unit, separate the low voltage wiring (remote controller wiring) and high voltage wiring (wiring between units, ground, and other power wiring) at least 2 in. so that they do not pass through the same place together. Proximity may cause electrical interference, malfunctions, and breakage.

Tightening torque for the terminal blocks

- Use the correct screwdriver for tightening the terminal screws. If the blade of screwdriver is too small, the head of the screw might be damaged, and the screw will not be properly tightened.
- If the terminal screws are tightened too hard, screws might be damaged.
- Refer to the table below for the tightening torque of the terminal screws.

unit: lbf • ft (N • m)

	Tightening torque
Terminal block for remote controller (6P)	0.58 - 0.72 (0.79 - 0.98)
Terminal block for power supply (4P)	0.87 - 1.06 (1.18 - 1.44)

- For electric wiring work, refer also to “**Wiring diagram label**” attached to the electrical wiring box cover.
- For remote controller wiring details, refer to the installation manual attached to the remote controller.
- A circuit breaker capable of shutting down power supply to the entire system must be installed.

- **Specifications for field wire**

The remote controller wiring should be procured locally.

Table 3

	Wire	Size	Length
Wiring between units	Recommend stranded and shielded. Local code supersedes recommendation.	AWG 14	–
Remote controller wiring	Sheathed (2 wire)	AWG 18 - 16	Max. 1640ft (500m)*
Wiring to ground terminal	Recommend stranded and shielded. Local code supersedes recommendation.	–	–

* This will be the total extended length in the system when doing group control.

CAUTION

- Arrange the wires and fix a cover firmly so that the cover does not float during wiring work.
- Do not clamp remote controller wiring together with wiring between units. Doing so may cause malfunction.
- Remote controller wiring and wiring between units should be located at least 2 inch (50mm) from other electric wires. Not following this guideline may result in malfunction due to electrical noise.

Indoor Unit Installation

Connection of wiring between units, ground wire and remote controller wiring

Wiring between units and ground wire

- 1) Remove the electrical wiring box cover (2 screws).

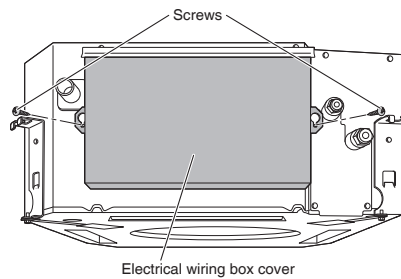

- 2) Insert the wires including the ground wire into the conduit, and secure the conduit to the hole in the electrical wiring box using a lock nut and the (N) washer for conduit, as shown in the illustration.

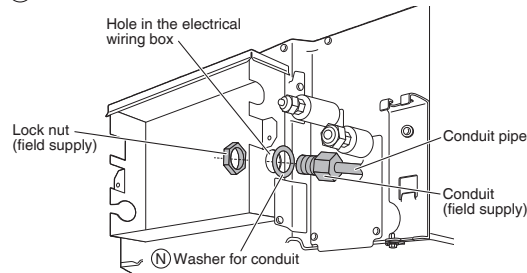

- 3) Connect the ground wire to the corresponding terminals.
 4) Match wire colors with terminal numbers on the terminal block for power supply of indoor and outdoor unit and firmly secure the wires in the corresponding terminals with screws.
 5) In doing this, pull the wires inside through the hole and fix the wires securely with the included (D) clamp.
 6) Give enough slack to the wires between the (D) clamp and terminal block for power supply.
 7) Pull the wires inside through the hole and connect them to the terminal block for remote controller (P1, P2) (no polarity). Securely fix the remote controller wiring with the included (D) clamp.
 8) Give enough slack to the wires between the (D) clamp and the terminal block for remote controller.
 9) Attach the electrical wiring box cover as before.
 10) After all wiring connections are done, fill in any gaps in the casing wiring holes with putty or (M) sealing pad (small) thus to prevent small animals or dirt from entering the unit from outside and causing short circuits in the electrical wiring box.

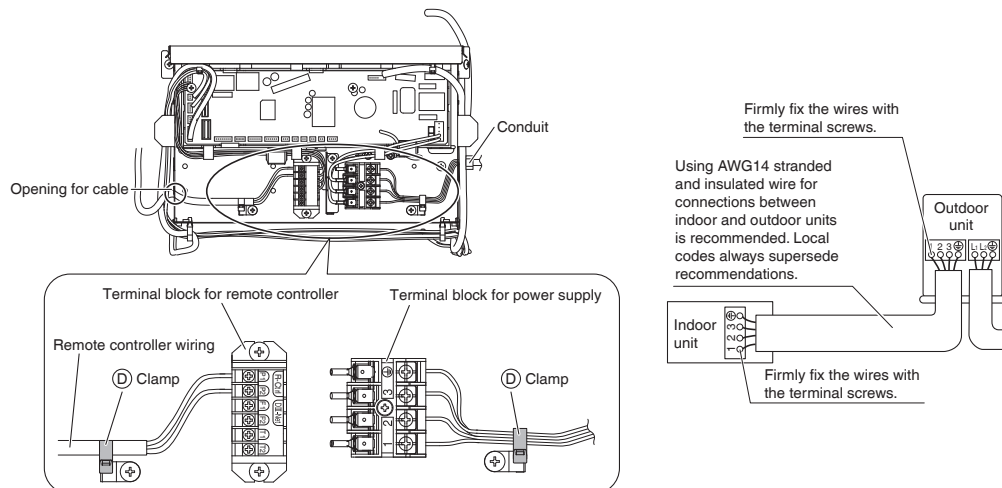

Refrigerant Piping Work

Refer also to the installation manual for the outdoor unit.

⚠ WARNING

- Do not apply mineral oil on flared part.
- Prevent mineral oil from getting into the system as this would reduce the service life of the units.
- Never use piping which has been used for previous installations. Only use parts which are delivered with the unit.
- Never install a dryer to this R410A unit in order to guarantee its service life.
- The drying material may dissolve and damage the system.
- Incomplete flaring may result in refrigerant gas leakage.

Execute thermal insulation work completely on both sides of the gas and the liquid piping. Otherwise, a water leakage can result sometimes.

Be sure to use insulation designed for use with HVAC systems.

Also, in cases where the temperature and humidity of the refrigerant piping sections might exceed 86°F (30°C) or RH80%, reinforce the refrigerant insulation. (13/16 inch (20mm) or thicker) Condensation may form on the surface of the insulating material.

Before refrigerant piping work, check which type of refrigerant is used. Proper operation is not possible if the types of refrigerant are not the same.

1. Flaring the pipe end

- 1) Cut the pipe end with a pipe cutter.
- 2) Remove burrs with the cut surface facing downward so that the filings do not enter the pipe.



- 3) Put the flare nut on the pipe.
- 4) Flare the pipe.
- 5) Check that the flaring has been done correctly.

Flaring

Set exactly at the position shown below.

	Conventional flare tool		
	Clutch-type	Clutch-type (Rigid-type)	Wing-nut type (Imperial-type)
A	0-0.020 inch (0-0.5mm)	0.039-0.059 inch (1.0-1.5mm)	0.059-0.079 inch (1.5-2.0mm)

Check

The flare's inner surface must be flaw-free.

The pipe end must be evenly flared in a perfect circle.

When flaring, do not over-tighten and crack.

Make sure that the flare nut is fitted.

2. Refrigerant piping

⚠ CAUTION

- Use the flare nut fixed to the main unit. (This is to prevent the flare nut from cracking as a result of deterioration over time.)
 - To prevent gas leakage, apply refrigeration oil only to the inner surface of the flare. (Use refrigeration oil for R410A.)
 - Use a torque wrench when tightening the flare nuts to prevent damage to the flare nuts and gas leakage.
- Align the centers of both flares and tighten the flare nuts 3 or 4 turns by hand, then tighten them fully with a spanner and a torque wrench.

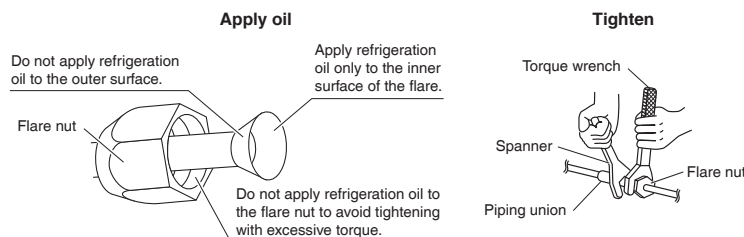

	Piping size	Flare nut tightening torque
Gas side	O.D. 3/8 inch (9.5mm)	24-1/8-29-1/2lbf • ft (32.7-39.9N • m)
	O.D. 1/2 inch (12.7mm)	36-1/2-44-1/2lbf • ft (49.5-60.3N • m)
Liquid side	O.D. 1/4 inch (6.4mm)	10-1/2-12-3/4lbf • ft (14.2-17.2N • m)

Cautions on piping handling

- Protect the open end of the pipe from dust and moisture.
- All pipe bends should be as gentle as possible. Use a pipe bender for bending.

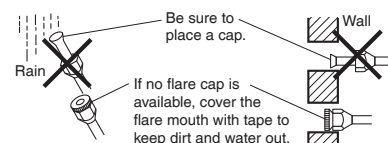

Refrigerant Piping Work

Selection of copper and heat insulation materials

When using commercial copper pipes and fittings, observe the following:

- Insulation material: Polyethylene foam
Heat transfer rate: 0.041 to 0.052W/mK (0.024 to 0.030Btu/ft²h°F (0.035 to 0.045kcal/mh°C))
Be sure to use insulation that is designed for use with HVAC Systems.
- ACR Copper pipe only.

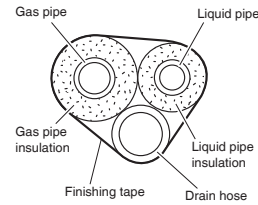

- Be sure to insulate both the gas and liquid piping and observe the insulation dimensions as below.

	Piping size	Minimum bend radius	Piping thickness	Thermal insulation size	Thermal insulation thickness
Gas side	O.D. 3/8 inch (9.5mm)	1-3/16 inch (30mm) or more	0.031 inch (0.8mm) (C1220T-O)	I.D. 15/32-19/32 inch (12-15mm)	13/32 inch (10mm) Min.
	O.D. 1/2 inch (12.7mm)	1-9/16 inch (40mm) or more		I.D. 9/16-5/8 inch (14-16mm)	
Liquid side	O.D. 1/4 inch (6.4mm)	1-3/16 inch (30mm) or more		I.D. 5/16-13/32 inch (8-10mm)	

- Use separate thermal insulation pipes for gas and liquid refrigerant pipes.
- Make absolutely sure to execute thermal insulation works on the pipe-connecting section, after checking for gas leakage, by thoroughly studying the following figures and using the included thermal insulating materials (G) fitting insulation and (H) fitting insulation. Fasten both ends with the (D) clamps.

Piping insulation procedure

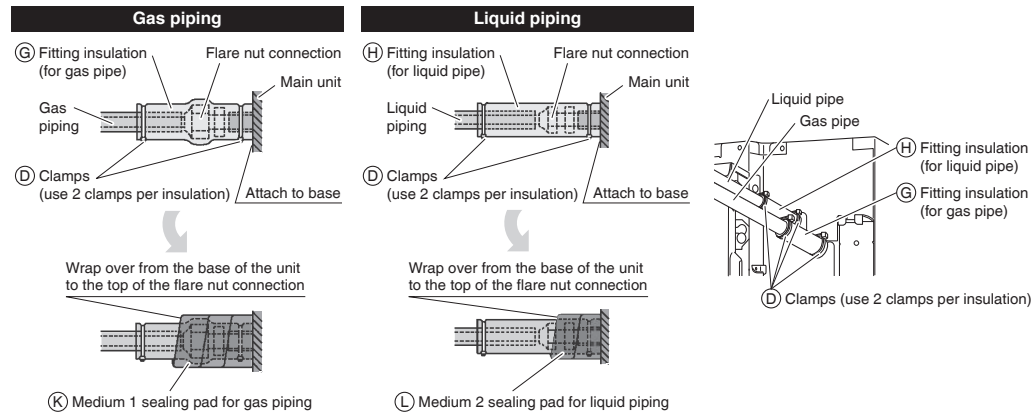

CAUTION

Be sure to insulate any field piping all the way to the piping connection inside the unit. Any exposed piping may cause condensation or burns if touched.

Installation of the Decoration Panel

With the wireless remote controller, field setting and trial operation cannot be performed without attaching the decoration panel.

Read "Trial Operation and Testing" before making a trial operation without attaching the decoration panel.

Refer to the installation manual attached to the decoration panel.

After installing the decoration panel, ensure that there is no space between the unit body and decoration panel.

Field Settings

⚠ CAUTION

When performing field setting or trial operation without attaching the decoration panel, do not touch the drain pump. This may cause electric shock.

- Make sure the electrical wiring box cover is closed on the indoor and outdoor units.
- Field settings must be made from the remote controller and in accordance with installation conditions.
- Setting can be made by changing the “Mode No.,” “FIRST CODE NO.” and “SECOND CODE NO.”.
- The “Field Settings” included with the remote control lists the order of the settings and method of operation.

Field Settings			
Unit No	Mode		
0	20		
0-01	1-01	2-02	3-01
4---	5---	6---	7---
8---	9---	10---	11---
12---	13---	14---	15---
Setting ⬅➡			

1. Setting air outlet direction

- For changing air outlet direction (2 or 3 directions), refer to the installation manual attached to the blocking pad kit (sold separately) or the service manual.
(SECOND CODE NO. is factory set to “01” for air outlet in 4 directions.)

2. Setting for options

- For settings for options, see the installation manual provided with the option.

3. Setting remote controller

When using wireless remote controllers

- When using the wireless remote controllers, wireless remote controller address setting is necessary. Refer to the installation manual attached to the wireless remote controller.

4. Setting air filter sign

- Remote controllers are equipped with liquid crystal display air filter signs to display the time to clean air filters.
- Change the SECOND CODE NO. depending on the amount of dirt or dust in the room.

AIR FILTER CLEANING TIME INDICATOR lamp display interval

Setting content	Contamination	Mode No.	FIRST CODE NO.	SECOND CODE NO.
Approx. 2500 hrs	Contamination-light	10 (20)	0	01
Approx. 1250 hrs	Contamination-heavy			02

AIR FILTER CLEANING TIME INDICATOR lamp display

Setting content	Mode No.	FIRST CODE NO.	SECOND CODE NO.
Display ON	10 (20)	3	01
Display OFF*			02

* Use “Display OFF” setting when cleaning indication is not necessary such as the case of periodical cleaning being carried out.

5. When implementing group control

- When using as a pair unit, you may control up to 16 units with the remote controller.
- In this case, all the indoor units in the group will operate in accordance with the group control remote controller.
- Select a remote controller which matches as many of the functions (swing flap, etc.) in the group as possible.

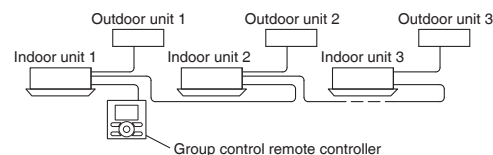

Wiring Method

- 1) Remove the electrical wiring box cover.
(Refer to Wiring between units and ground wire in “6. Wiring” on page 13.)
- 2) Cross-wire the terminal block for remote controller (P1, P2) inside the electrical wiring box. (There is no polarity.)
(Refer to Table 3 in “6. Wiring” on page 12)

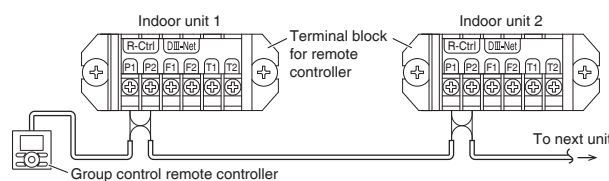

Field Settings

6. 2 remote controllers (controlling 1 indoor unit by 2 remote controllers)

- When using 2 remote controllers, one must be set to "MAIN" and the other to "SUB".

Wiring Method

- Remove the electrical wiring box cover.
(Refer to Wiring between units and ground wire in "6. Wiring" on page 13.)
- Add remote controller 2 to the terminal block for remote controller (P1, P2) in the electrical wiring box. (There is no polarity.)
(Refer to Table 3 in "6. Wiring" on page 12)

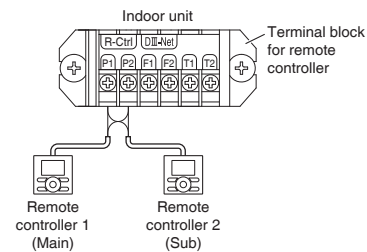

Trial Operation and Testing

⚠ CAUTION

When performing field settings or trial operation without attaching the decoration panel, do not touch the drain pump. This may cause electric shock.

- After finishing the construction of refrigerant piping, drain piping, and electric wiring, conduct trial operation accordingly to protect the unit.

1. Trial operation and testing

Make sure to install the decoration panel before carrying out trial operation if the wireless remote controller is used.

- Trial operation should be carried out in either COOL or HEAT operation.

1-1. Measure the supply voltage and make sure that it is within the specified range.

1-2. In COOL operation, select the lowest programmable temperature;

in HEAT operation, select the highest programmable temperature.

1-3. Carry out the trial operation following the instructions in the operation manual to ensure that all functions and parts, such as the movement of the louvers, are working properly.

- To protect the air conditioner, restart operation is disabled for 3 minutes after the system has been turned off.



1-4. After trial operation is complete, set the temperature to a normal level (78°F to 82°F (26°C to 28°C) in COOL operation, 68°F to 75°F (20°C to 24°C) in HEAT operation).

- When operating the air conditioner in COOL operation in winter, or HEAT operation in summer, set it to the trial operation mode using the following method.

Refer to **For wired remote controller** on page 18.

Refer to **For wireless remote controller**.

For wireless remote controller

- Press  and select the COOL or HEAT operation.
- Press  twice. "Test" is displayed.
- Press  within 10 seconds, and the test operation starts.

Monitor the operation of the indoor unit for a minimum of 10 minutes. During test operation, the indoor unit will continue to cool/heat regardless of the temperature setpoint and room temperature.

- In the case of above-mentioned procedures 1) and 2) in reverse order, test operation can start as well.

- Test operation will stop automatically after 15 - 30 minutes. To stop the operation, press .
- Some of the functions cannot be used in the test operation mode.

For wired remote controller

- 1) Set to COOL or HEAT operation using the remote controller.
- 2) Press and hold Cancel button for 4 seconds or longer. Service settings menu is displayed.
- 3) Select **Test Operation** in the service settings menu, and press Menu/OK button. Basic screen returns and “Test Operation” is displayed at the bottom.
- 4) Press On/Off button within 10 seconds, and the test operation starts.
Monitor the operation of the indoor unit for a minimum of 10 minutes. During test operation, the indoor unit will continue to cool/heat regardless of the temperature setpoint and room temperature.
 - In the case of above-mentioned procedures 3) and 4) in reverse order, test operation can start as well.
- 5) Press Menu/OK button in the basic screen. Main menu is displayed.
- 6) Select **Air Flow Direction** in the main menu and check that air flow direction is actuated according to the setting. For operation of air flow direction setting, see the operation manual.
- 7) After the operation of air flow direction is confirmed, press Menu/OK button. Basic screen returns.
- 8) Press and hold Cancel button for 4 seconds or longer in the basic screen. Service settings menu is displayed.
- 9) Select **Test Operation** in the service settings menu, and press Menu/OK button. Basic screen returns and normal operation is conducted.
 - Test operation will stop automatically after 15-30 minutes. To stop the operation, press On/Off button.
- 10) If the decoration panel has not been installed, turn off the power after the test operation.

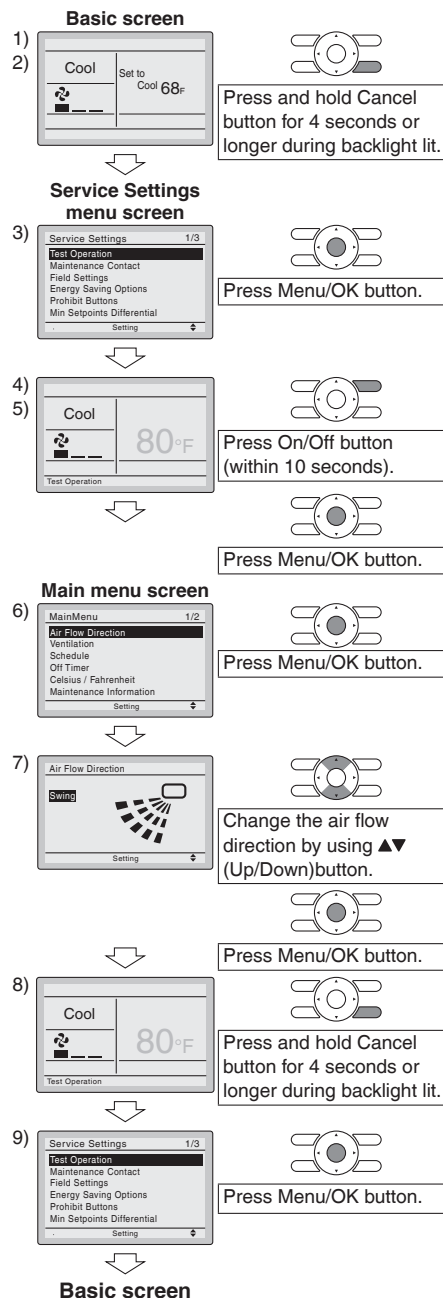

Precautions

Refer to “3. How to diagnose for malfunction” if the unit does not operate properly.

Trial Operation and Testing

2. Test items

Test items	Symptom	Check
Indoor and outdoor units are installed securely.	Fall, vibration, noise	
Is the outdoor unit fully installed?	No operation or burn damage	
No refrigerant gas leaks.	Incomplete cooling/heating function	
Refrigerant gas and liquid pipes and indoor drain hose extension are thermally insulated.	Water leakage	
Draining line is properly installed.	Water leakage	
Does the power supply voltage correspond to that shown on the name plate?	No operation or burn damage	
Only specified wires are used for all wiring, and all wires are connected correctly.	No operation or burn damage	
System is properly grounded.	Electrical leakage	
Is wiring size according to specifications?	No operation or burn damage	
Is something blocking the air outlet or inlet of either the indoor or outdoor units?	Incomplete cooling/heating function	
Are refrigerant piping length and additional refrigerant charge noted down?	The refrigerant charge in the system is not clear	
Pipes and wires are connected to the corresponding connection ports / terminal blocks for the connected unit.	No cooling/heating	
Stop valves are opened.	Incomplete cooling/heating function	
Check that the connector of the lead wires of the decoration panel is connected securely.	Louvers do not move	
Indoor unit properly receives wireless remote control commands.	No operation	

Items to be checked at time of delivery

Also review the "Precautions" on page 3

Test items	Check
Are the electrical wiring box cover, air filter, suction grille attached?	
Did you explain about operations while showing the operation manual to your customer?	
Did you hand the operation manual over to your customer?	

Points for explanation about operations

The items with ⚠ WARNING and ⚠ CAUTION marks in the operation manual are the items pertaining to possibilities for bodily injury and material damage in addition to the general usage of the product. Accordingly, it is necessary that you make a full explanation about the described contents and also ask your customers to read the operation manual.

Note to the installer

Be sure to instruct customers how to properly operate the unit (especially cleaning the filter, operating different functions, and adjusting the temperature) by having them carry out operations while looking at the manual.

3. How to diagnose for malfunction

- If the air conditioner does not operate normally after installing the air conditioner, a malfunction shown in the table below may happen.

Wired remote controller display	Description
No display	<ul style="list-style-type: none"> • Power outage, power voltage error or open-phase • Incorrect wiring (between indoor and outdoor units) • Indoor PC-board assembly failure • Remote controller wiring not connected • Remote controller failure • Open fuse or tripped circuit breaker (outdoor unit)
“Checking the connection. Please stand by.” *	<ul style="list-style-type: none"> • Indoor PC-board assembly failure • Wrong wiring (between indoor and outdoor units)

* “Checking the connection. Please stand by.” will be displayed for up to 90 seconds following the application of power to the indoor unit. This is normal and does not indicate a malfunction.

- Diagnose with the display on the liquid crystal display remote controller.

With the wired remote controller

When the operation stops due to a malfunction, operation lamp blinks, and the malfunction code is indicated on the liquid crystal display. In such a case, diagnose the fault contents by referring to **Error History** in the service settings menu. In the case of group control, the unit No. is displayed so that the indoor unit with the trouble can be identified.

With the wireless remote controller

(Refer also to the operation manual attached to the wireless remote controller)

When the operation stops due to a malfunction the display on the indoor unit blinks. In such a case, diagnose the fault contents with the error code which can be found by following procedures.

- 1) Press the INSPECTION/TEST OPERATION button, “” is displayed and “0” blinks.
- 2) Press the TEMPERATURE SETTING button and find the unit No. which stopped due to trouble.

Number of beeps	3 short beeps.....	Perform all the following operations
	1 short beep	Perform (3) and (6)
	1 long beep.....	No trouble
- 3) Press the OPERATION MODE SELECTOR button and upper figure of the error code blinks.
- 4) Continue pressing the TEMPERATURE SETTING button until it makes 2 short beeps and find the upper code.
- 5) Press the OPERATION MODE SELECTOR button and lower figure of the error code blinks.
- 6) Continue pressing the TEMPERATURE SETTING button until it makes a long beep and find the lower code.
 - A long beep indicate the error code.

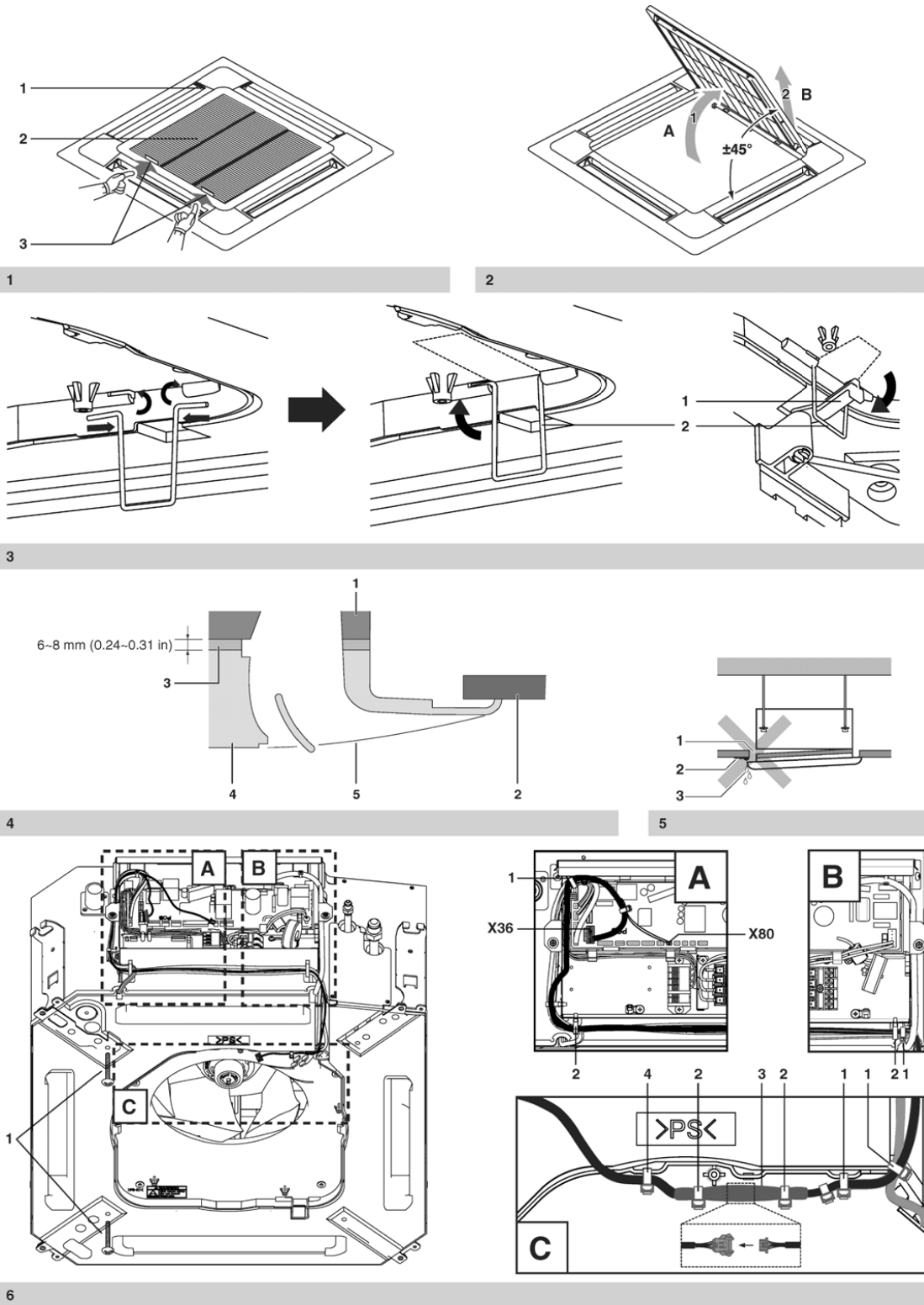

! The English text is the original instruction. Other languages are translations of the original instructions.

Read this manual attentively before installation. Do not throw it away. Keep it in your files for future reference.

Improper installation or attachment of equipment or accessories could result in electric shock, short-circuit, leaks, fire or other damage to the equipment. Be sure only to use accessories made by Daikin that are specifically designed for the use with the equipment and have them installed by a professional.

If unsure of installation procedures or use, always contact your dealer for advice and information.

Before installation

- Leave the unit inside its packaging until you reach the installation site.

! **Rotary fan**









Cut off the main power before opening the grille.

- Refer to the installation manual of the indoor unit for items not described in this manual.

NOTE **To the installer**

 Be sure to instruct the customer how to properly operate the system showing him or her the operation manual of the indoor unit.

Accessories

Installation manual		Wire harness	
Screws (4x)		Temporary latch	
Fibre glass tube		Tie wrap (7x)	

Preparation before installation

For this unit, you are able to select air flow directions. To discharge air in 2 or 3 directions, it is necessary to purchase the optional blocking pad kit for sealing air discharge outlets.

Handling of the decoration panel

- To prevent any damage to the decoration panel, take care of the following:
- Never place the decoration panel facing down.
 - Never let the decoration panel lean against a wall.
 - Never place the decoration panel on a sharp or projecting object.
 - Never touch or put pressure on the swing flap in order to prevent malfunction of the swing flap.

Preparing the decoration panel for installation

- 1 Remove the suction grille from the decoration panel.
 - 1 Decoration panel
 - 2 Suction grille
 - 3 Lever
 - Push the suction grille lever (3) inward and open the suction grille (2). (See figure 1)
 - Detach the suction grille from the decoration panel by lifting the suction grille up approximately 45 degrees (A) until the position is reached on which removal of the suction grille is possible (B). (See figure 2)

Installation of the decoration panel to the indoor unit

Refer to the installation manual of the indoor unit for details on installing the indoor unit.

Installation and wiring of the decoration panel.

! Make sure to turn off the power supply before wiring!

For installation and wiring of the decoration panel see figure 6.

- 1 Screws
- A**
- 1 Tie wrap
 - 2 Latch
- Socket X36
Socket X80
- B**
- 1 Tie wrap
 - 2 Latch
- C**
- 1 Tie wrap
 - 2 Tie wrap
 - 3 Fibre glass tube
 - 4 Tie wrap

- 1 Attach wire harness from panel accessory set to unit and to other wire harness by two tie wraps (1). (See figure 6-C)
- 2 Lead the wire harness through unit's groove and attach it by tie wrap (1) to the rest of wire harnesses. (See figure 6-B)
- 3 Open two latches (2) and insert the wire harness so it is in the same condition as other wire harnesses. (See figure 6-A and 6-B)
- 4 Insert wire harness into switch box using lower hole, insert two connectors into proper sockets (X36, X80) and secure the wire harness by tie wrap (1). (See figure 6-A)
- 5 Provisionally tighten the 2 supplied screws (1) approximately 5 mm (0.2 in) into the indoor unit as marked in figure. (See figure 6)

- 6 Attach latch (2) from panel accessory set to unit according to figure 3. Then turn this latch up. (See figure 3)
- 7 Slide the panel over the provisionally tightened screws matching the 2 attachment holes (□).
- 8 Turn decoration panel lever (1) 90 degrees and then turn temporary latch (2) down to secure panel in temporary position. (See figure 3)
- 9 Attach remaining screws and tighten all 4 screws until the thickness of the sealing material between the decoration panel and the indoor unit reduces to 6-8 mm. (See figure 4)

- 1 Indoor unit
- 2 Ceiling
- 3 Sealing material
- 4 Decoration panel
- 5 Air outlet

- 10 Pull the fibre glass tube (3) over decoration panel wire harness. Then connect both wire harnesses together and move the fibre glass tube over this connection. Secure the fiber glass tube by two tie wraps (2) according to figure 6-C. Then attach decoration panel wire harness to unit by tie wrap (4). (See figure 6-C)



Make sure that the swing flap motor lead wire is not caught between the indoor unit and the decoration panel and inbetween the electric component box lid.

Precautions

- Improper tightening of the screws - (See figure 5) - may cause air to leak into the unit and between the ceiling and the decoration panel (1), resulting in formation of contamination (2) and dew (3).
- If there is a gap remaining between the ceiling and the decoration panel after tightening the screws, re-adjust the indoor unit body height. The indoor unit must be kept leveled and the drain piping kept unaffected.

Installation of the suction grille

Install the suction grille by reversing the procedure shown in "Preparing the decoration panel for installation" on page 1.

- The suction grille may be installed in 4 directions by simply turning it 90 degrees.
- Change the direction when adjusting the direction of the suction grille of multiple units or to comply with the demands of the customer.

NOTE



Be careful not to get the swing flap motor lead wire get caught when installing the suction grille.

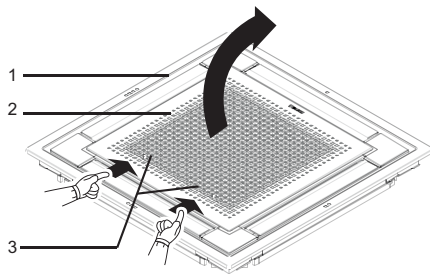

1

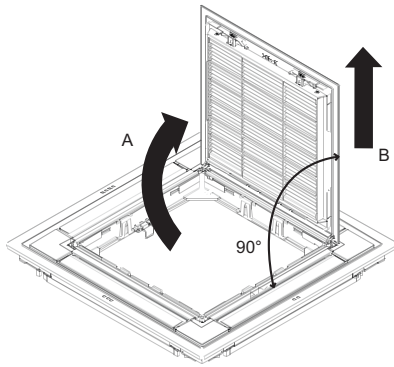

2

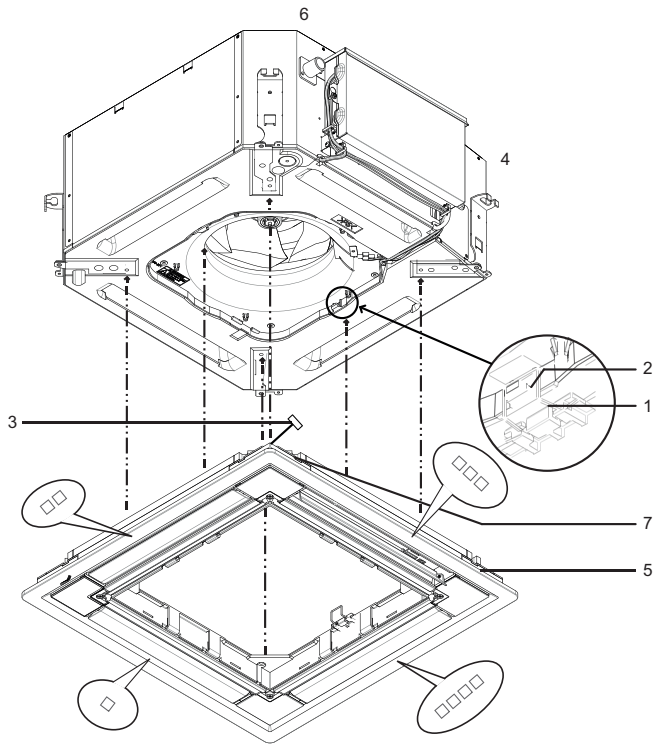

3

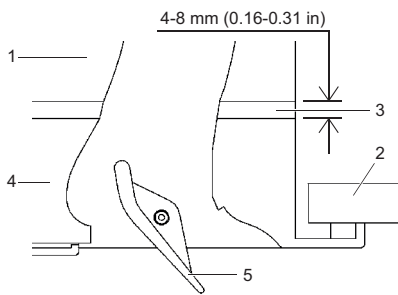

4

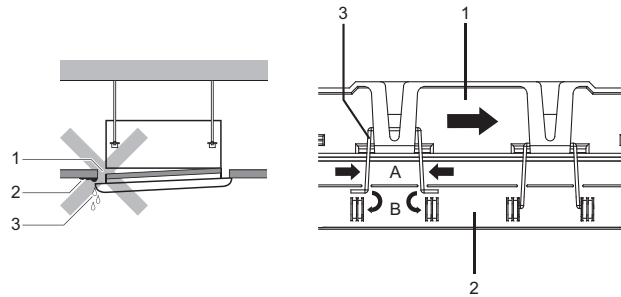

5

7

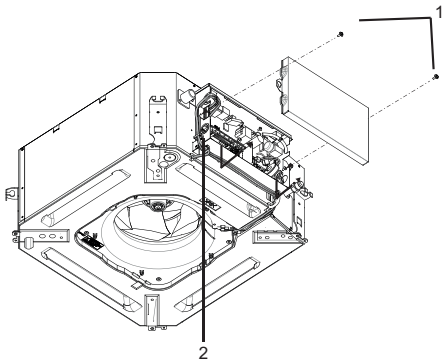

6

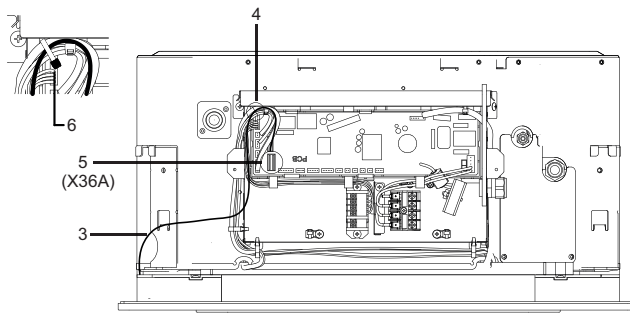



The English text is the original instruction. Other languages are translations of the original instructions.

Read this manual attentively before installation. Do not throw it away. Keep it in your files for future reference.

Improper installation or attachment of equipment or accessories could result in electric shock, short-circuit, leaks, fire or other damage to the equipment. Be sure only to use accessories made by Daikin that are specifically designed for the use with the equipment and have them installed by a professional.

If unsure of installation procedures or use, always contact your dealer for advice and information.

Before installation

- Leave the unit inside its packaging until you reach the installation site.



Rotary fan



Cut off the main power before opening the grille.

- Refer to the installation manual of the indoor unit for items not described in this manual.



NOTE To the installer

Be sure to instruct the customer how to properly operate the system showing him or her the operation manual of the indoor unit.

Accessories

Installation manual	
Screws (4x)	
Grille hinge (2x)	

Preparation before installation

For this unit, you are able to select air flow directions. To discharge air in 2 or 3 directions, it is necessary to purchase the optional blocking pad kit for sealing air discharge outlets.

Handling of the decoration panel

To prevent any damage to the decoration panel, take care of the following:

- Never place the decoration panel facing down.
- Never let the decoration panel lean against a wall.
- Never place the decoration panel on a sharp or projecting object.
- Never touch or put pressure on the swing flap in order to prevent malfunction of the swing flap.

Preparing the decoration panel for installation

- 1 Remove the suction grille from the decoration panel.

- 1 Decoration panel
- 2 Suction grille
- 3 Lever

- Remove the transporting tape from the decoration panel suction grille and flaps.
- Push the suction grille lever (3) inward and open the suction grille (2). (See figure 1)
- Detach the suction grille from the decoration panel by lifting the suction grille up approximately 90 degrees (A) until the position is reached on which removal of the suction grille is possible (B). (See figure 2)

Installation of the decoration panel to the indoor unit

Refer to the installation manual of the indoor unit for details on installing the indoor unit.

- 1 Install the decoration panel (See figure 3)

- 1 Temporary latch
- 2 Hook
- 3 Swing flap motor lead wire
- 4 Piping area
- 5 Piping side mark
- 6 Drain area
- 7 Drain side mark

- 1 Hold the decoration panel against the indoor unit by matching the piping side and drain side marks on the decoration panel with the position of the piping area and drain area of the indoor unit.
- 2 Turn 2 panel temporary latches up into the hooks of the indoor unit so the decoration panel is temporarily fixed to the indoor unit. (See figure 3)
- 3 Make sure that the swing flap motor lead wire isn't caught between the decoration panel and the indoor unit.
- 4 Attach 4 supplied screws and check whether the decoration panel is properly aligned with the indoor unit and ceiling.
- 5 Tighten all 4 screws until the thickness between of the sealing material between the decoration panel and the indoor unit reduces to 4-8 mm. (See figure 4)

- 1 Indoor unit
- 2 Ceiling
- 3 Sealing material
- 4 Decoration panel
- 5 Air outlet

Precautions

- Improper tightening of the screws - (See figure 5) - may cause air to leak into the unit and between the ceiling and the decoration panel (1), resulting in formation of contamination (2) and dew (3).
- If there is a gap remaining between the ceiling and the decoration panel after tightening the screws, re-adjust the indoor unit body height. The indoor unit must be kept leveled and the drain piping kept unaffected.

2 Wiring of the decoration panel (See figure 6)

Make sure to turn off the power supply before wiring!

- 1 Screws (2)
- 2 Switch box
- 3 Swing flap motor lead wire
- 4 Swing flap motor lead wire fixed by tie wrap to the rest of the wires (See detail in figure 6)
- 5 Connector of the indoor unit PCB (X36A)
- 6 Tie wrap

- 1 Remove the electric components box lid. Loosen 2 screws and slide the electric components box lid in the direction of the arrows.
- 2 Securely connect the connector of swing flap motor lead wire installed on the decoration panel. Attach the swing flap motor lead wire to the rest of the wires firmly by tie wrap (from indoor unit accessory set). (See figure 6)
- 3 Replace the electric components box lid reversing the procedure to remove it.



Make sure that the swing flap motor lead wire is not caught between the indoor unit and the decoration panel and inbetween the electric component box lid.

Installation of the suction grille to decoration panel

Install the suction grille (See figure 7)

- 1 Decoration panel
- 2 Suction grille
- 3 Suction grille hinge (attached to decoration panel)

- 1 Remove the transportation tape which is securing 2 suction grille hinges in place.
- 2 Attach the suction grille to hinges by pressing the hinge and inserting both ends of hinge to holes on the suction grille. (See figure 7)
- 3 Make sure that the suction grille is attached to the decoration panel properly by 2 hinges.
- 4 Close the suction grille by reversing the procedure shown in "Preparing the decoration panel for installation" on page 1.
 - The suction grille may be installed in 4 directions by simply turning it 90 degrees.
 - Change the direction when adjusting the direction of the suction grille of multiple units or to comply with the demands of the customer.

2. Outdoor Unit

2.1 2/3/4MXS, 2/3MXL, 2/3MXLH

Contents

Safety Considerations	1	5. Pressure test and evacuating system.....	10
Accessories	3	6. Refilling refrigerant	11
Precautions for Selecting a Location	3	7. Charging with refrigerant	11
Precautions on Installation	4	Wiring	12
Outdoor Unit Installation Diagram	4	Priority Room Setting	14
Installation Space Requirements	5	Night Quiet Mode setting	15
Selecting a Location for Installation of the Indoor Units	5	COOL/ HEAT mode lock [S15]	15
Connections (connection port)	6	When attaching the optional drain pan heater (excluding 2MXLH, 3MXLH models)	16
How to Use Reducers	7	Pump Down Operation	16
Outdoor Unit Installation	8	Trial Operation and Testing	17
1. Installing the outdoor unit	8	1. Wiring error check	17
2. Drain work	8	2. Trial operation and testing	18
3. Flaring the pipe end.....	8	3. Test items	18
4. Refrigerant piping.....	9		

The pictures in this document are for illustrative purposes only.

Safety Considerations

Refer also to the General Safety Considerations in the separate booklet.

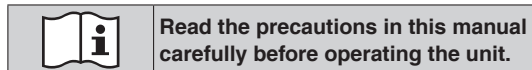

Read the precautions in this manual carefully before operating the unit.

Read these **Safety Considerations for Installation** carefully before installing an air conditioner or heat pump. After completing the installation, make sure that the unit operates properly during the startup operation.

Instruct the user on how to operate and maintain the unit.

Inform users that they should store this installation manual with the operation manual for future reference.

Always use a licensed installer or contractor to install this product. Improper installation can result in water or refrigerant leakage, electric shock, fire, or explosion.

Meanings of **DANGER**, **WARNING**, **CAUTION**, and **NOTE**

Symbols:

- DANGER** Indicates an imminently hazardous situation which, if not avoided, will result in death or serious injury.
- WARNING** Indicates a potentially hazardous situation which, if not avoided, could result in death or serious injury.
- CAUTION** Indicates a potentially hazardous situation which, if not avoided, may result in minor or moderate injury. It may also be used to alert against unsafe practices.
- NOTE** Indicates situations that may result in equipment or property damage accidents only.

DANGER

- Refrigerant gas is heavier than air and replaces oxygen. A massive leak can lead to oxygen depletion, especially in basements, and an asphyxiation hazard could occur leading to serious injury or death.
- Do not ground units to water pipes, gas pipes, telephone wires, or lightning rods as incomplete grounding can cause a severe shock hazard resulting in severe injury or death. Additionally, grounding to gas pipes could cause a gas leak and potential explosion causing severe injury or death.

- If refrigerant gas leaks during installation, ventilate the area immediately. Refrigerant gas may produce toxic gas if it comes into contact with fire. Exposure to this gas could cause severe injury or death.
- After completing the installation work, check that the refrigerant gas does not leak throughout the system.
- Do not install unit in an area where flammable materials are present due to risk of explosions that can cause serious injury or death.
- Safely dispose all packing and transportation materials in accordance with federal/state/local laws or ordinances. Packing materials such as nails and other metal or wood parts, including plastic packing materials used for transportation may cause injury or death by suffocation.

WARNING

- Only qualified personnel licensed or certified in their jurisdiction must carry out the installation work. Installation must be done in accordance with this installation manual. Improper installation may result in water leakage, electric shock, or fire.
- When installing the unit in a small room, take measures to keep the refrigerant concentration from exceeding allowable safety limits. Excessive refrigerant leaks, in the event of an accident in a closed ambient space, can lead to oxygen deficiency.
- Use only specified accessories and parts for installation work. Failure to use specified parts may result in water leakage, electric shock, fire, or the unit falling.
- Install the air conditioner or heat pump on a foundation strong enough that it can withstand the weight of the unit. A foundation of insufficient strength may result in the unit falling and causing injuries.
- Take into account strong winds, typhoons, or earthquakes when installing. Improper installation may result in the unit falling and causing accidents.
- Make sure that a separate power supply circuit is provided for this unit and that all electrical work is carried out by qualified personnel licensed or certified in their jurisdiction according to local, state, and national regulations. An insufficient power supply capacity or improper electrical construction may lead to electric shock or fire.

- Make sure that all wiring is secured, that specified wires are used, and that no external forces act on the terminal connections or wires. Improper connections or installation may result in fire.
- When wiring, position the wires so that the service lid can be securely fastened. Improper positioning of the service lid may result in electric shock, fire, or the terminals overheating.
- Before touching electrical parts, turn off the unit.
- The circuit must be protected with safety devices in accordance with local and national codes, i.e. a circuit breaker.
- Securely fasten the outdoor unit service lid. If the service lid is not installed properly, dust or water may enter the outdoor unit causing fire or electric shock.
- When installing or relocating the system, keep the refrigerant circuit free from substances other than the specified refrigerant (R410A) such as air. Any presence of air or other foreign substance in the refrigerant circuit can cause an abnormal pressure rise or rupture, which may result in equipment damage and even injury.
- Do not change the setting of the protection devices. If the pressure switch, thermal switch, or other protection device is shorted and operated forcibly, or parts other than those specified by Daikin are used, fire or explosion may occur.
- Do not use means to accelerate the defrosting process (if possible) or to clean, other than those recommended by the manufacturer.
- The appliance must be stored in a room without continuously operating ignition sources (for example: open flames, an operating gas appliance or an operating electric heater).
- Do not pierce or burn.
- Be aware that refrigerants may not contain an odor.
- Comply with national gas regulations.

CAUTION

- Do not touch the switch with wet fingers. Touching a switch with wet fingers can cause electric shock.
- Do not allow children to play on or around the unit to prevent injury.
- Wear adequate personal protective equipment (protective gloves, safety glasses,...) when installing, maintaining or servicing the system.
- The heat exchanger fins are sharp enough to cut. To avoid injury, wear gloves or cover the fins while working around them.
- Do not touch the refrigerant pipes during and immediately after operation as the refrigerant pipes may be hot or cold, depending on the condition of the refrigerant flowing through the refrigerant piping, compressor, and other refrigerant cycle parts. Your hands may suffer burns or frostbite if you touch the refrigerant pipes. To avoid injury, give the pipes time to return to normal temperature or, if you must touch them, be sure to wear proper gloves.
- Install drain piping to ensure proper drainage. Improper drain piping may result in water leakage and property damage.
- Insulate piping to prevent condensation.
- Be careful when transporting the product.
- Do not turn off the power immediately after stopping operation. Always wait for at least 5 minutes before turning off the power. Otherwise, water leakage may occur.
- Do not use a charging cylinder. Using a charging cylinder may cause the refrigerant to deteriorate.
- Refrigerant R410A in the system must be kept clean, dry, and tight.
 - (a) Clean and Dry -- Foreign materials (including mineral oils such as SUNISO oil or moisture) should be prevented from getting into the system.



- (b) Tight -- R410A does not contain any chlorine, does not destroy the ozone layer, and does not reduce the earth's protection against harmful ultraviolet radiation. R410A can contribute to the greenhouse effect if it is released. Therefore take proper measures to check for the tightness of the refrigerant piping installation. Read the chapter *Refrigerant Piping* and follow the procedures.
- Since R410A is a blend, the required additional refrigerant must be charged in its liquid state. If the refrigerant is charged in a state of gas, its composition can change and the system will not work properly.
 - The outdoor unit is for R410A. See the catalog for indoor models that can be connected. Normal operation is not possible when connected to non-compatible indoor units.
 - Remote controller (wireless kit) transmitting distance can be shorter than expected in rooms with electronic fluorescent lamps (inverter or rapid start types). Install the indoor unit far away from fluorescent lamps as much as possible.
 - Indoor units are for indoor installation only. Outdoor units can be installed either outdoors or indoors.
 - Do not install the air conditioner or heat pump in the following locations:
 - (a) Where a mineral oil mist or oil spray or vapor is produced, for example, in a kitchen. Plastic parts may deteriorate and fall off or result in water leakage.
 - (b) Where corrosive gas, such as sulfurous acid gas, is produced. Corroding copper pipes or soldered parts may result in refrigerant leakage.
 - (c) Near machinery emitting electromagnetic waves. Electromagnetic waves may disturb the operation of the control system and cause the unit to malfunction.
 - (d) Where flammable gas may leak, where there is carbon fiber, or ignitable dust suspension in the air, or where volatile flammables such as thinner or gasoline are handled. Operating the unit in such conditions can cause a fire.
 - Take adequate measures to prevent the outdoor unit from being used as a shelter by small animals. Small animals making contact with electrical parts can cause malfunctions, smoke, or fire. Instruct the user to keep the area around the unit clean.
 - Servicing shall be performed only as recommended by the manufacturer and licensed or certified in their jurisdiction.

NOTE

- The outdoor unit should be positioned where the unit and power supply wires (breaker panel to outdoor unit) are at least 10ft (3m) away from any televisions or radios. (The unit may cause interference with the picture or sound.) Depending on the radio waves, a distance of 10ft (3m) may not be sufficient to eliminate the noise.
- Dismantling the unit, treatment of the refrigerant, oil and additional parts must be done in accordance with the relevant local, state, and national regulations.
- Only use tools for R410A, such as a gauge manifold, charge hose, gas leak detector, reverse flow check valve, refrigerant charge base, vacuum gauge, or refrigerant recovery equipment.
- If the conventional refrigerant and refrigerator oil are mixed in R410A, the refrigerant may deteriorate.
- This air conditioner or heat pump is an appliance that should not be accessible to the general public.
- As maximum allowable pressure is 604psi (4.17MPa), the wall thickness of field-installed pipes should be selected in accordance with the relevant local, state, and national regulations.

RN006-U

Accessories

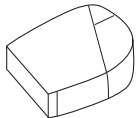
<p>Ⓐ Installation manual</p>	<p>1</p>	<p>Ⓑ Drain socket</p>  <p>This is at the bottom of the packaging.</p>	<p>1</p>	<p>Ⓒ Drain cap (1)</p> 	<p>6</p>
<p>Ⓓ Drain cap (2)</p> 	<p>3</p>	<p>Ⓔ Reducer assy</p> 	<p>1</p>	<p>Ⓕ Warranty</p>	<p>1</p>
				<p>Ⓖ General safety consideration</p>	<p>1</p>

Precautions for Selecting a Location

- 1) Choose a place solid enough to bear the weight and vibration of the unit, where the operating sound will not be amplified.
- 2) Choose a location where the air discharged from the unit or the operating sound will not cause a nuisance to the neighbors of the user.
- 3) Avoid locations, such as near bedrooms, where the operating sound may cause disturbance.
- 4) There must be sufficient space to carry the unit into and out of the site.
- 5) There must be sufficient space for air passage and no obstructions around the air inlet and the air outlet.
- 6) The site must not be prone to flammable gas leaks in the surrounding area.
- 7) In coastal areas or other places with salty atmosphere or one containing sulfate gas, corrosion may shorten the life of the air conditioner.
- 8) Since water will flow from the drain of the outdoor unit, do not place anything under the unit which must be kept away from moisture.
- 9) A location where flammable gas does not leak. Position at least 6-5/8ft (2m) from propane gas cylinders.

NOTE

Cannot be installed suspended from a ceiling or stacked.

⚠ CAUTION

When operating the air conditioner in a low outdoor ambient temperature, be sure to follow the instructions described below.

- To prevent exposure to wind, install the outdoor unit with its suction side facing the wall.
- Never install the outdoor unit at a site where the suction side may be exposed directly to wind.
- To prevent exposure to wind, it is recommended to install a baffle plate on the air discharge side of the outdoor unit.
- In heavy snow areas, select an installation site where the snow will not affect the unit.
- If there is a likelihood of snow accumulating on the outdoor unit, attach a snow protection hood.
- In high humidity areas or heavy snow areas, it is recommended to attach a drain pan heater to prevent ice build-up from the bottom frame.

- Construct a large canopy.
- Construct a pedestal.



Install the unit high enough off the ground to prevent burying in snow.

Precautions on Installation

- Check the strength and level of the installation surface so that the unit does not cause any operating vibrations or noise after installation.
- Fix the unit in place securely using foundation bolts, as in the figure. (Prepare 4 sets of 5/16 inch (M8) or 3/8 inch (M10) foundation bolts, nuts and washers; all sold separately.)
- It is best to screw in the foundation bolts until their ends are 3/4 inch (20mm) from the foundation surface.

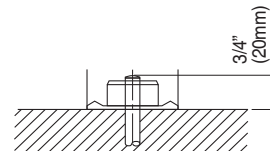

Outdoor Unit Installation Diagram

⚠ CAUTION

- Do not connect the embedded branch piping and the outdoor unit when only carrying out piping work without connecting the indoor unit in order to add another indoor unit later.
Make sure no dirt or moisture gets into either side of the embedded branch piping.
Refer to "4. Refrigerant piping" on page 9 for details.
- It is not possible to have only 1 indoor unit connected. **Be sure to connect at least 2 indoor units.**

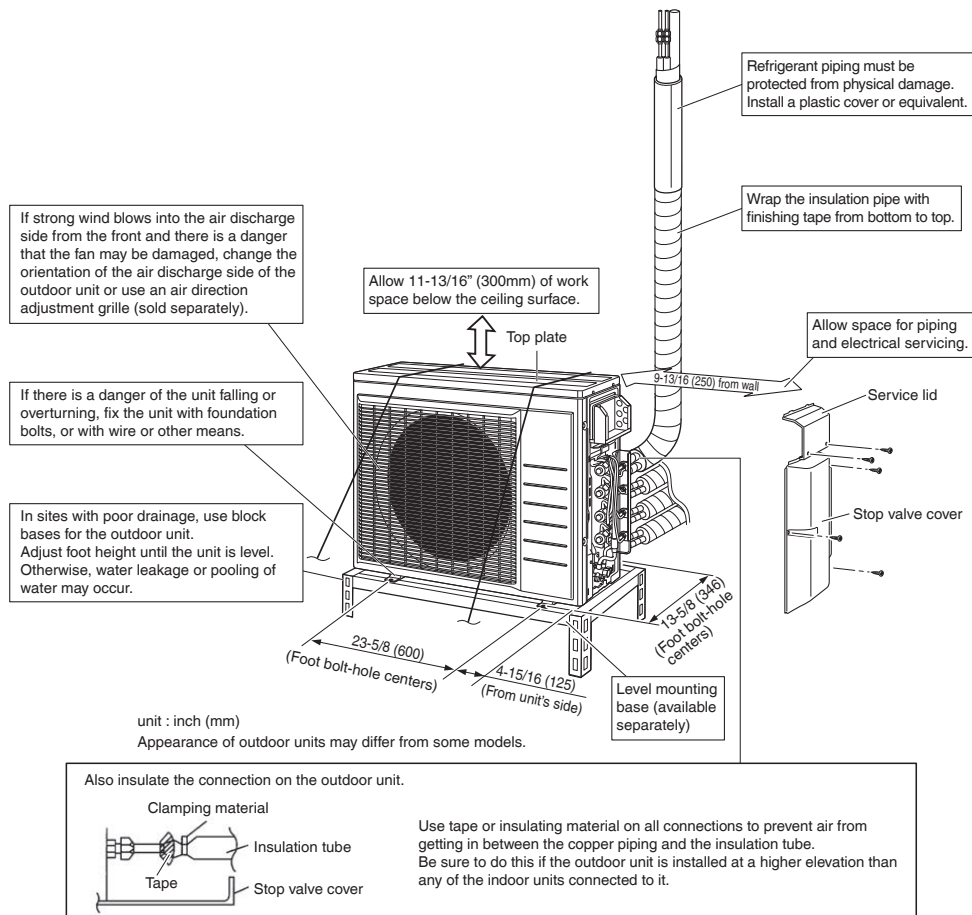

Installation Space Requirements

- Position the unit on a horizontal surface. Any tilt in the unit should be 3° or less to the horizontal.
- Where a wall or other obstacle is in the path of outdoor unit's intake or exhaust airflow, follow the installation space requirements below.
- For any of the below installation patterns, the wall height on the outlet side should be 47-1/4 inch (1200mm) or less.
- Secure as much installation space around the unit as the location allows, as more space will result in more efficient operation.

Wall facing one side

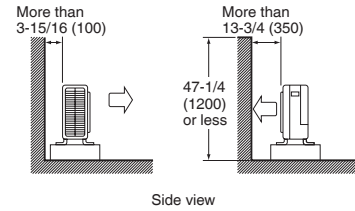

Walls facing two sides

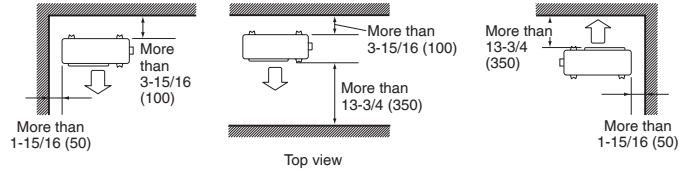

Walls facing three sides

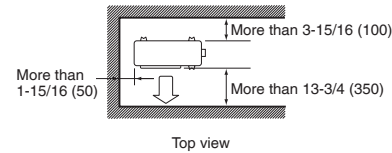

When installed as in the figure on the left, it is recommended to either change the orientation of the outdoor unit outlet side or use the air direction adjustment grille (sold separately).

unit: inch (mm)

Selecting a Location for Installation of the Indoor Units

- The maximum allowable length of refrigerant piping, and the maximum allowable height difference between the outdoor and indoor units, are listed below.
- Refrigerant piping must be kept to a minimum.
The suggested shortest pipe length per room is 10ft (3m), in order to avoid noise from the outdoor unit and vibration.
(Mechanical noise and vibration may occur depending on how the unit is installed and the environment in which it is used.)

Outdoor unit capacity class	2MXS*, 2MXL*	3MXS*, 4MXS*, 3MXL*
Piping to each indoor unit	82ft (25m) max. 10ft (3m) min.	
Total length of piping between all units	164ft (50m) max.	230ft (70m) max.

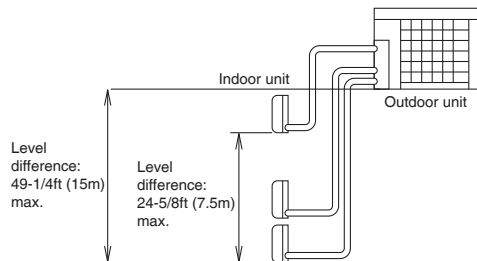

If the outdoor unit is positioned higher than the indoor units.

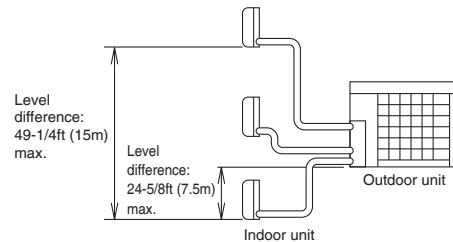

If the outdoor unit is positioned lower than one or more indoor units.

Connections (connection port)

Install the indoor unit according to the table below, which shows the relationship between the class of indoor unit and the corresponding port.

The total indoor unit class that can be connected to this unit:

2MXS*, 2MXL* – Up to 24000 Btu

3MXS*, 3MXL* – Up to 39000 Btu

4MXS* – Up to 48000 Btu

The line set piping size is determined by the size of the indoor unit fittings.

Reducers are used at the outdoor unit to accommodate the correct gas line pipe size.

Port	2MXS*, 2MXL*	3MXS*, 3MXL*	4MXS*
A	07, 09, 12	07, 09, 12	07, 09, 12
B	# [○] 07, # [○] 09, # [○] 12, 15	# [○] 07, # [○] 09, # [○] 12, 15, 18	# [○] 07, # [○] 09, # [○] 12, 15, 18
C	————	# [○] 07, # [○] 09, # [○] 12, 15, 18	# [○] 07, # [○] 09, # [○] 12, 15, 18
D	————	————	[△] 07, [△] 09, [△] 12, [□] 15, [□] 18, 24

○ : Use a reducer to connect pipes.

□ : Use No. 1 and 3 reducers

: Use No. 2 and 4 reducers

△ : Use No. 5 and 6 reducers

Refer to **"How to Use Reducers"** on page 7 for information on reducer numbers and their shapes.

How to Use Reducers

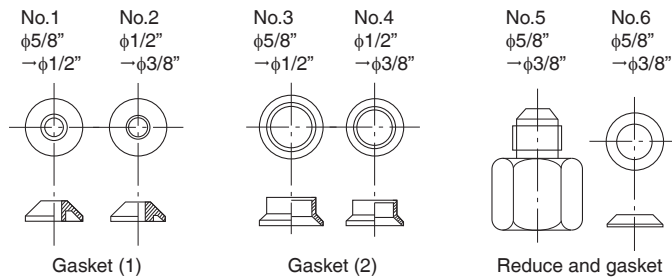

• Use the reducers supplied with the unit as described below.

(1) Connecting a pipe of $\phi 1/2$ inch (12.7mm) to a gas pipe connection port for $\phi 5/8$ inch (15.9mm) :

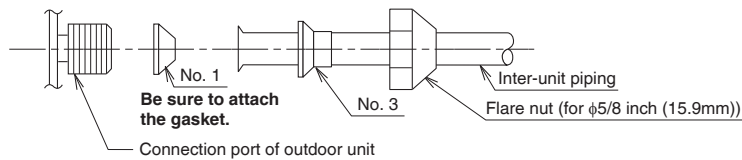

(2) Connecting a pipe of $\phi 3/8$ inch (9.5mm) to a gas pipe connection port for $\phi 1/2$ inch (12.7mm) :

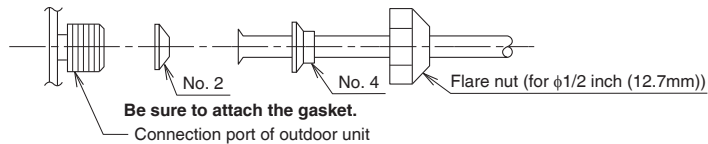

(3) Connecting a pipe of $\phi 3/8$ inch (9.5mm) to a gas pipe connection port for $\phi 5/8$ inch (15.9mm) :

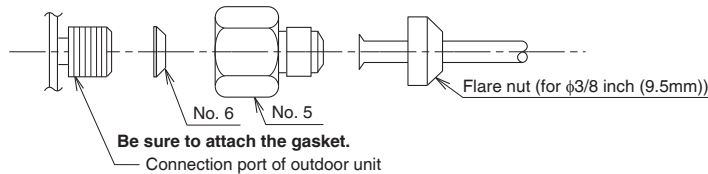

- When using the reducer packing shown above, be careful not to overtighten the nut, or the smaller pipe may become damaged. (Apply about 2/3 to 3/3 the normal torque.)
- Apply a coat of refrigeration oil to the threaded connection port of the outdoor unit where the flare nut comes in.
- Use an appropriate wrench to avoid damaging the connection thread by overtightening the flare nut.

Flare nut tightening torque	
$\phi 3/8$ inch (9.5mm)	24-1/8 – 29-1/2lbf • ft (32.7-39.9N • m)
$\phi 1/2$ inch (12.7mm)	36-1/2 – 44-1/2lbf • ft (49.5-60.3N • m)
$\phi 5/8$ inch (15.9mm)	45-5/8 – 55-5/8lbf • ft (61.8-75.4N • m)

Outdoor Unit Installation

1. Installing the outdoor unit

- When installing the outdoor unit, refer to "Precautions for Selecting a Location" on page 3 and the "Outdoor Unit Installation Diagram" on page 4.
- If drain work is necessary, follow the procedures below.

2. Drain work

⚠ CAUTION

In cold areas, do not use a drain socket, drain caps (1,2) and a drain hose with the outdoor unit. (Drain water may freeze, impairing heating performance.)

- If the drain port is covered by a mounting base or floor surface, place additional foot bases of at least 1-1/4 inch (30mm) in height under the outdoor unit's feet.
- Attach ① drain cap (1) and ② drain cap (2).
 - Attach ③ drain socket.
 - When attaching ③ drain socket to the bottom frame, make sure to connect the drain hose to the drain socket first.

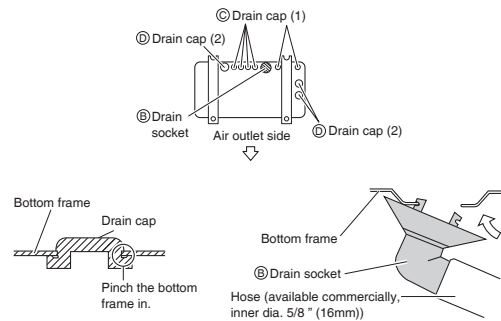

3. Flaring the pipe end

⚠ WARNING

- Do not apply mineral oil to the flare.
- Prevent mineral oil from getting into the system as this would reduce the service life of the units.
- Never use piping which has been used for previous installations. Only use parts which are delivered with this unit.
- Never install a dryer to this R410A unit in order to guarantee its service life.
- The drying material may dissolve and damage the system.
- Improper flaring may result in refrigerant gas leakage.

⚠ CAUTION

Do not reuse joints which have been used once already.

- Cut the pipe end with a pipe cutter.
- Remove burrs with the cut surface facing downward, so that the filings do not enter the pipe.
- Put the flare nut on the pipe.
- Flare the pipe.
- Check that the flaring has been done correctly.

Cut exactly at right angles.

Remove burrs.

Check

The flare's inner surface must be flaw-free.

The pipe end must be evenly flared in a perfect circle.

When flaring, do not over-tighten and crack.

Make sure that the flare nut is fitted.

Flaring

Set exactly at the position shown below.

A	Flare tool for R410A		
	Clutch-type	Clutch-type (Rigid-type)	Conventional flare tool Wing-nut type (Imperial-type)
	0-0.020 inch (0-0.5mm)	0.039-0.059 inch (1.0-1.5mm)	0.059-0.079 inch (1.5-2.0mm)

Outdoor Unit Installation

4. Refrigerant piping

⚠ CAUTION

- Use the flare nut fixed to the main unit. (This is to prevent the flare nut from cracking as a result of deterioration over time.)
- To prevent gas leakage, apply refrigeration oil only to the inner surface of the flare. (Use refrigeration oil for R410A.)
- Use a torque wrench when tightening the flare nuts to prevent damage to the flare nuts and gas leakage.

- Align the centers of both flares and tighten the flare nuts 3 or 4 turns by hand, then tighten them fully with a spanner and a torque wrench.

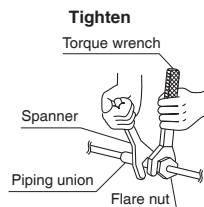
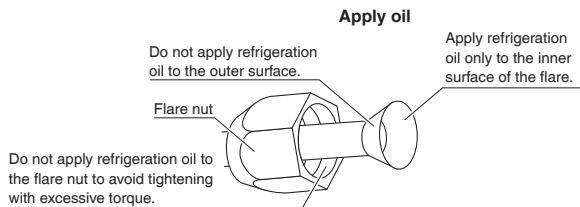

Tightening torque

Piping connection

Flare nut			
Gas side		Liquid side	
3/8 inch (9.5mm)	1/2 inch (12.7mm)	5/8 inch (15.9mm)	1/4 inch (6.4mm)
24-1/8 – 29-1/2 lbf • ft (32.7-39.9N • m)	36-1/2 – 44-1/2 lbf • ft (49.5-60.3N • m)	45-5/8 – 55-5/8 lbf • ft (61.8-75.4N • m)	10-1/2 – 12-3/4 lbf • ft (14.2-17.2N • m)

Valve cap

Width across flats	
3/4 inch (19mm)	7/8 inch (22mm)
12-5/8 – 15-3/8 lbf • ft (17.0-20.9N • m)	16 – 20-1/4 lbf • ft (21.6-27.4N • m)

Service port cap

8 – 10-7/8 lbf • ft (10.7-14.7N • m)

Cautions on pipe handling

- Protect the open end of the pipe from dust and moisture.
- All pipe bends should be as gentle as possible. Use a pipe bender for bending.

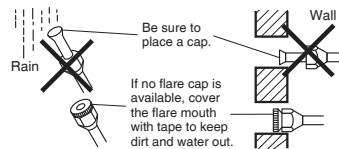

Selection of copper and heat insulation materials

When using commercial copper pipes and fittings, observe the following:

- Insulation material: Polyethylene foam
Heat transfer rate: 0.041 to 0.052W/mK (0.024 to 0.030Btu/ft•°F) (0.035 to 0.045kcal/mh•°C)
Be sure to use insulation that is designed for use with HVAC Systems.
- ACR Copper only.
- Be sure to insulate both the gas and liquid piping and observe the insulation dimensions as below.

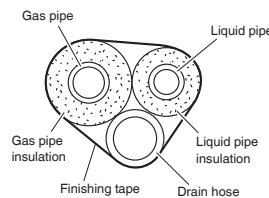

	Piping size	Minimum bend radius	Piping thickness	Thermal insulation size	Thermal insulation thickness
Gas side	O.D. 3/8 inch (9.5mm)	1-3/16 inch (30mm) or more	0.031 inch (0.8mm) (C1220T-O)	I.D. 15/32-19/32 inch (12-15mm)	13/32 inch (10mm) Min.
	O.D. 1/2 inch (12.7mm)	1-9/16 inch (40mm) or more		I.D. 9/16-5/8 inch (14-16mm)	
	O.D. 5/8 inch (15.9mm)	1-15/16 inch (50mm) or more	0.039 inch (1.0mm) (C1220T-O)	I.D. 5/8-13/16 inch (16-20mm)	
Liquid side	O.D. 1/4 inch (6.4mm)	1-3/16 inch (30mm) or more	0.031 inch (0.8mm) (C1220T-O)	I.D. 5/16-13/32 inch (8-10mm)	

- Use separate thermal insulation pipes for gas and liquid refrigerant pipes.
- Using finishing tape, bundle and wrap the indoor unit piping and drain hose together so that the drain hose is below the other piping.

5. Pressure test and evacuating system

⚠ WARNING

- Make sure that air or any matter other than refrigerant (R410A) does not get into the refrigeration cycle.
- If refrigerant gas leaks should occur, ventilate the room as soon and as much as possible.
- R410A, as well as other refrigerants, should always be recovered and never be released directly into the environment.
- Use a vacuum pump for R410A exclusively. Using the same vacuum pump for different refrigerants may damage the vacuum pump or the unit.

⚠ CAUTION

It is highly recommended that you do not open/close the stop valves when the outdoor temperature is below -5°F (-21°C) as this may result in refrigerant leakage.

- When piping work is complete, it is necessary to perform a pressure test and evacuate system with a vacuum pump.
- If using additional refrigerant, purge the air from the refrigerant pipes and indoor unit using a vacuum pump, then charge additional refrigerant.
- Use a hexagonal wrench (3/16 inch (4mm)) to operate the stop valve.
- All refrigerant pipe joints should be tightened with a torque wrench to the specified tightening torque.

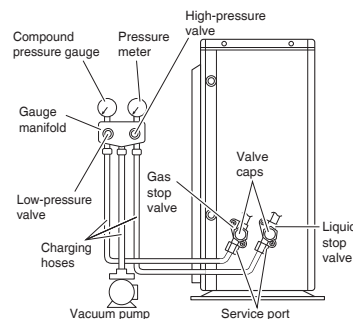

- 1) Pressurize the liquid pipe and gas pipe from the service ports of each stop valve to 604psi (4.17MPa) (do not pressurize more than 604psi (4.17MPa)) for 1 hour minimum, 24 hours recommended. If there is a pressure drop, check for leaks, make repairs and perform the pressure test again.
- 2) Connect the gauge manifold's charging hoses to the service ports of each stop valve.
- 3) Fully open the low-pressure valve (Lo) and the high-pressure valve (Hi) on the gauge manifold.
- 4) Evacuate system using vacuum pump to below 500 microns for 1 hour minimum.
- 5) Close the low-pressure valve (Lo) and the high-pressure valve (Hi) on the gauge manifold and stop vacuum pump. (Maintain this condition for 4-5 minutes to make sure that the compound pressure gauge pointer does not swing back.)*1
- 6) Remove the valve caps from the liquid stop valve and gas stop valve.
- 7) To open the liquid stop valve, turn the rod of the valve 90° counter-clockwise using a hexagonal wrench. Close it after 5 seconds, and check for gas leakage. Using soapy water, check for gas leakage from the indoor unit's flare and outdoor unit's flare and valve rods. After the check is complete, wipe all soapy water off.
- 8) Disconnect the charging hoses from the service ports, then fully open the liquid and gas stop valves. (Do not attempt to turn the valve rods further than they can go.)
- 9) Tighten the valve caps and service port caps for the liquid and gas stop valves with a torque wrench to the specified torques. Refer to "4. Refrigerant piping" on page 9 for details.

*1 If the compound pressure gauge pointer swings back, the refrigerant may have water content or there may be a loose pipe joint. Check all pipe joints and retighten nuts as needed, then repeat steps 3) through 5).

Outdoor Unit Installation

6. Refilling refrigerant

Check the type of refrigerant to be used on the machine nameplate.

Precautions when adding R410A

Fill from the liquid pipe in liquid form.

R410A is a mixed refrigerant, so adding it in gas form may cause the refrigerant composition to change, preventing normal operation.

- 1) Before filling, check whether the cylinder has a siphon attached or not. (It should have something like “liquid filling siphon attached” displayed on it.)

Filling a cylinder with an attached siphon

Stand the cylinder upright when filling.



(There is a siphon pipe inside, so the cylinder need not be upside-down to fill with liquid.)

Filling other cylinders

Turn the cylinder upside-down when filling.



- Be sure to use the R410A tools to ensure pressure and to prevent foreign objects from entering.

7. Charging with refrigerant

⚠ CAUTION

Even though the stop valve is fully closed, the refrigerant may slowly leak out; do not leave the flare nut removed for a long period of time.

- If the total length of piping for all rooms exceeds the figure listed below, additionally charge with 0.21oz/ft (20g/m) of refrigerant (R410A) for each additional piping length. Be sure to add the proper amount of additional refrigerant. Failure to do so may result in reduced performance.

Outdoor unit capacity class	2MXS*, 2MXL*	3MXS*, 4MXS*, 3MXL*
Total length of piping for all rooms	98-3/8ft (30m)	131-1/4ft (40m)

Wiring

⚠ WARNING

- Do not ground units to water pipes, gas pipes, telephone wires, or lightning rods as incomplete grounding can cause a severe shock hazard resulting in severe injury or death. Additionally, grounding to gas pipes could cause a gas leak and potential explosion causing severe injury or death.
- Do not use tapped wires, extension cords, or starburst connections, as they may cause overheating, electric shock, or fire.
- Do not use locally purchased electrical parts inside the product. (Do not branch the power for the drain pump, etc., from the terminal block.) Doing so may cause electric shock or fire.
- The circuit must be protected with safety devices in accordance with local and national codes, i.e. a circuit breaker.
- Use an all-pole disconnection type circuit breaker with at least 1/8 inch (3mm) between the contact point gaps.
- When carrying out wiring, take care not to pull at the conduit.
- Do not connect the power wire to the indoor unit. Doing so may cause electric shock or fire.
- Do not turn on the circuit breaker until all work is completed.

⚠ CAUTION

Precautions to be taken for power supply wiring

Recommend stranded cable for interunit wiring. Local code always supersedes recommendation.

- For stranded wires, make sure to use the round crimp-style terminal for connection to the power supply terminal block. Place the round crimp-style terminals on the wires up to the covered part and secure in place.

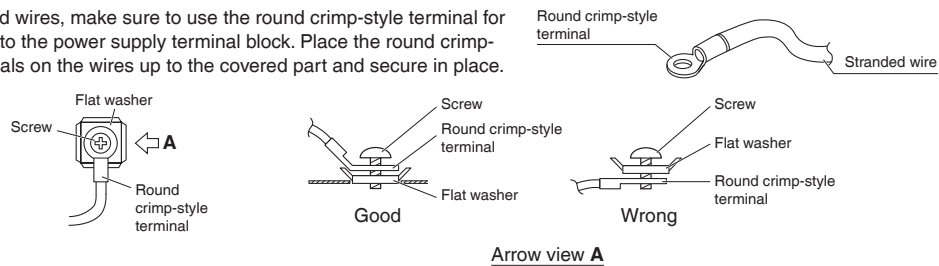

- If solid core wire must be used, be sure to curl the end of the lead. Improper work may cause heat and fire.

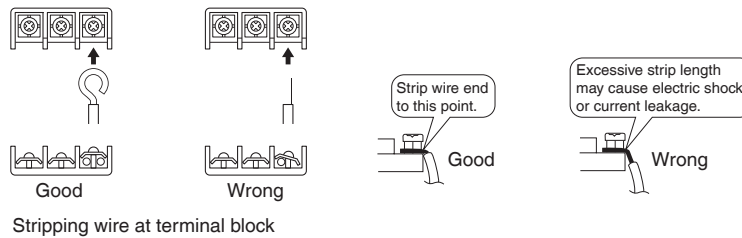

Wiring

[Method of Mounting Conduit]

• When connecting indoor units for 3 rooms or more, open knockout holes without deforming the conduit mounting plate.

- 1) Dismount the service lid by removing the 2 screws.
- 2) Slide the protection plate up and remove it.
- 3) Pass wires through the conduit and secure them with a lock nut.

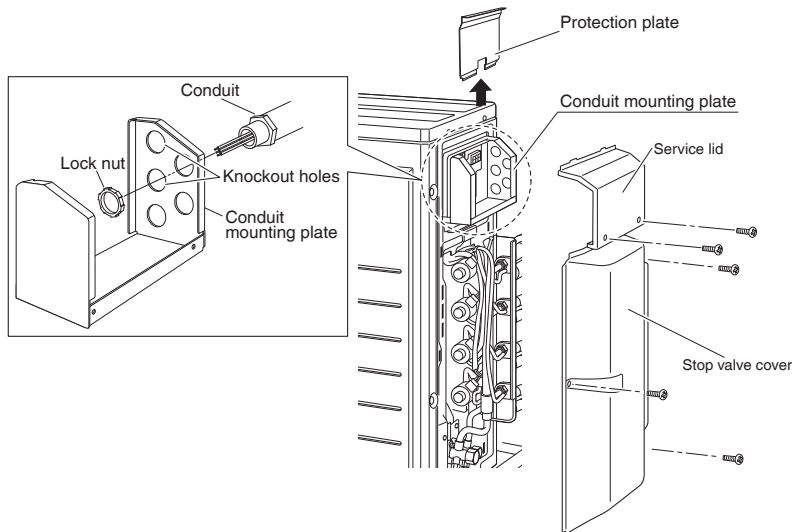

[Wiring procedure]

- 1) Strip the insulation from the wire (3/4inch (20mm)).
- 2) Connect the inter-unit wires between the indoor and outdoor units **so that the terminal numbers match**. Tighten the terminal screws securely. It is recommended that a slot-head screwdriver be used to tighten the screws.
- 3) **Be sure to match the symbols for wiring and piping.**
- 4) Pull the wire lightly to make sure that it does not disconnect.
- 5) Pass the wiring through the cutout on the bottom of the protection plate and attach the protection plate.
- 6) After completing the work, reattach the service lid to its original position.

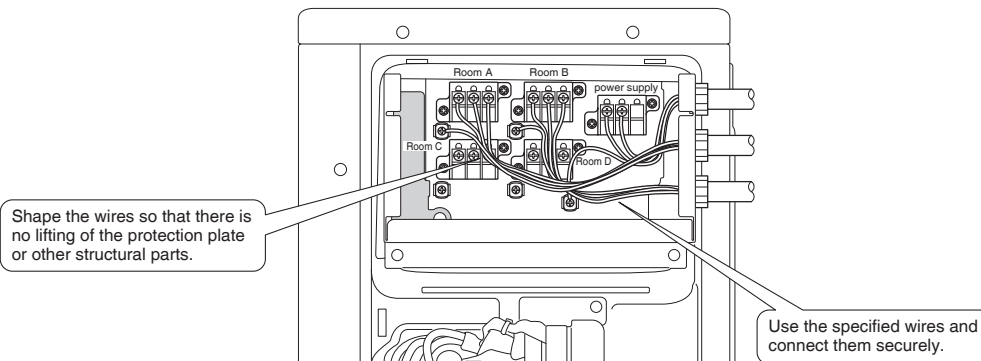
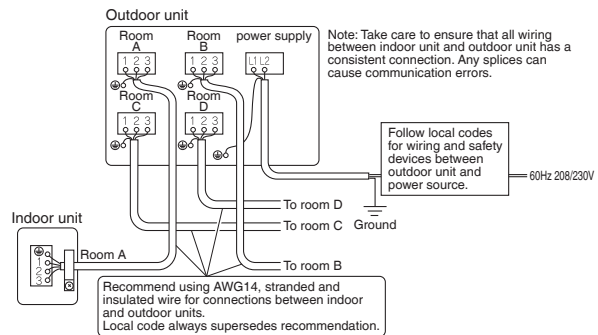

Ground

This air conditioner must be grounded. For grounding, follow all local, and state electrical codes.

Priority Room Setting

- To use priority room setting, initial settings must be made when the unit is installed. Explain the priority room setting, as described below, to the user, and confirm whether or not the user wants to use priority room setting. Setting it in the guest and living rooms is convenient.

About the priority room setting function

The indoor unit for which priority room setting is applied takes priority in the following cases.

1) Operation mode priority

The operation mode of the indoor unit which is set for priority room setting takes priority. If the set indoor unit is operating, all other indoor units do not operate and enter standby mode, according to the operation mode of the set indoor unit.

2) Priority during powerful operation

If the indoor unit which is set for priority room setting is operating at powerful, the capabilities of other indoor units will be somewhat reduced. Power supply gives priority to the indoor unit which is set for priority room setting.

3) Quiet operation priority

Setting the indoor unit to quiet operation will make the outdoor unit run quietly.

Setting procedure

Slide the priority room setting switch (SW4) to the on side for the switch that corresponds to the piping connected to the indoor unit to be set.

(In the figure below, it is room A.)

Once the settings are complete, switch the power on.

Be sure to set only one room

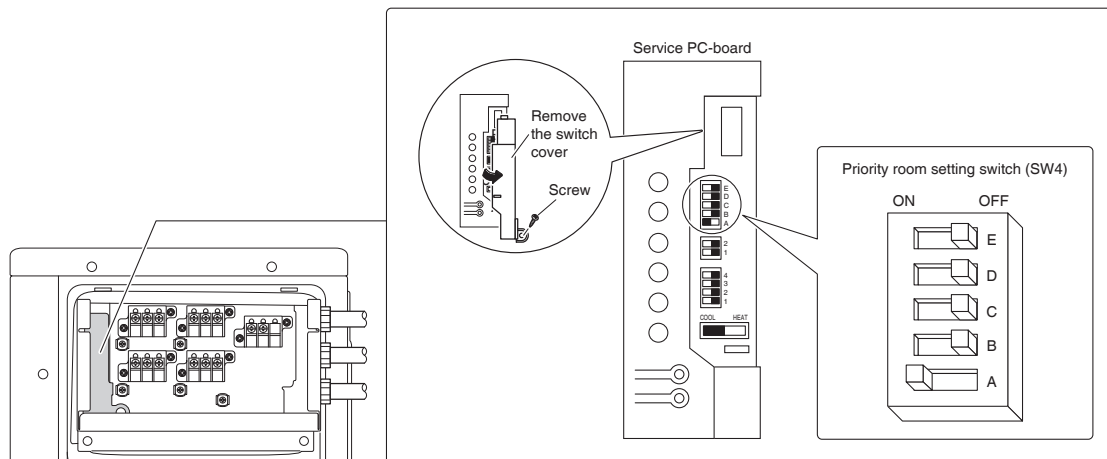

Night Quiet Mode setting

- If night quiet mode is to be used, initial settings must be made when the unit is installed. Explain night quiet mode, as described below, to the user, and confirm whether or not the user wants to use night quiet mode.

About night quiet mode

The night quiet mode function reduces operating noise of the outdoor unit at nighttime. This function is useful if the user is worried about the effects of the operating noise on the neighbors.

However, cooling capacity will be reduced when operating in night quiet mode.

Setting procedure

Turn the night quiet mode switch (SW6-1) to on.

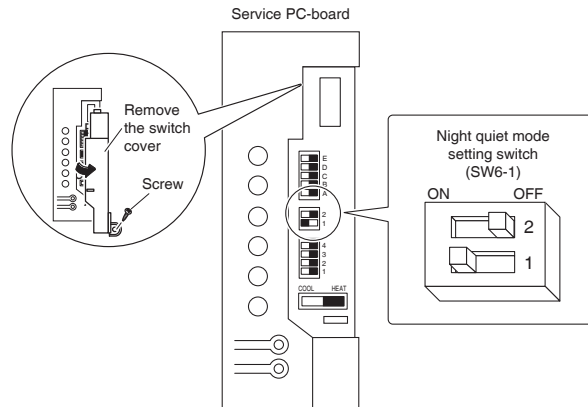

COOL/ HEAT mode lock [S15]

- Use the S15 connector to set the unit to only cool or heat.
 Setting to only heat (H) : short-circuit pins 1 and 3 of the connector [S15]
 Setting to only cool (C) : short-circuit pins 3 and 5 of the connector [S15]
 The following specifications apply to the connector housing and pins.

JST products Housing: VHR-5N

Pin: SVH-21T-P1.1

Note that forced operation is also possible in COOL/HEAT mode.

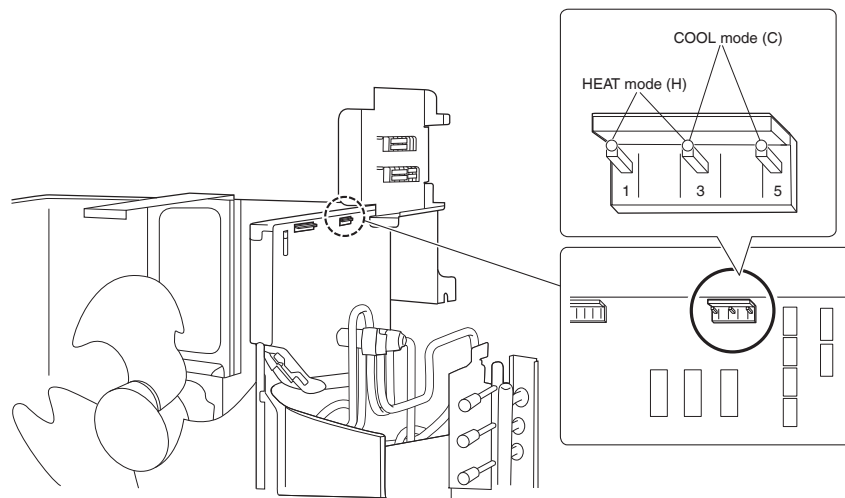

When attaching the optional drain pan heater (excluding 2MXLH, 3MXLH models)

⚠ WARNING

Do not remove the switch cover unless the power has been turned off. (Risk of electric shock)

- 1) Attach the drain pan heater in accordance with the installation manual included with the drain pan heater.
- 2) Using a tool such as nippers, cut the jumper (J_DP) on the service PC-board.

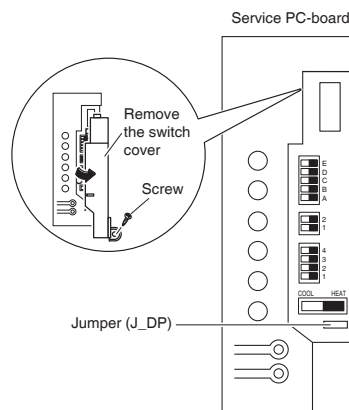

Pump Down Operation

In order to protect the environment, be sure to pump down when relocating or disposing of the unit.

- 1) Remove the valve caps from liquid stop valve and gas stop valve.
- 2) Begin forced cooling operation.
- 3) After 3 to 5 minutes, close the liquid stop valve with a hexagonal wrench.
- 4) After 3 to 4 minutes, close the gas stop valve and stop forced cooling operation.
- 5) Attach the valve caps once procedures are complete.

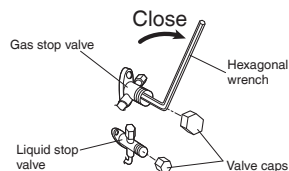

Forced cooling operation

⚠ WARNING

Do not remove the switch cover unless the power has been turned off. (Risk of electric shock)

- 1) Turn off the power.
- 2) Remove the service lid (2 screws).
- 3) Remove the service PC-board switch cover (1 screw).
- 4) Switch SW5 and SW6 to off.
- 5) Turn the operation mode switch (SW2) to COOL.
- 6) Screw the service PC-board switch cover back on (1 screw).
- 7) Turn on the power.
- 8) Push the forced operation switch (SW1) above the service PC-board cover. (The operation will start.)
 - Forced cooling operation will stop automatically after about 11 to 15 minutes. To stop the operation, push the forced operation switch (SW1).

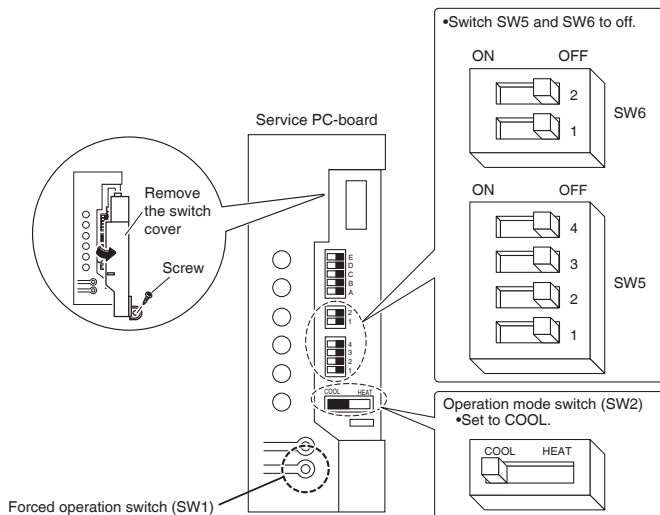

16

Trial Operation and Testing

- Before starting the trial operation, measure the voltage at the primary side of the circuit breaker.
- Check that all liquid and gas stop valves are fully open.
- Check that piping and wiring all match. The wiring error check can be conveniently used for underground wiring and other wiring that cannot be directly checked. However, if the outside air temperature is **41°F (5°C) or less**, the wiring error check function will not operate.
- When trial operation is conducted directly after the circuit breaker is turned on, in some cases no air will be output for about 15 minutes in order to protect the air conditioner.

1. Wiring error check

This product is capable of automatic correction of wiring errors.

Press the wiring error check switch on the outdoor unit service PC-board. However, the wiring error check switch will not function for 3 minutes after the safety breaker is turned on. About 15-20 minutes after the switch is pressed, the errors in the connection wiring will be corrected.

The service monitor LEDs indicate whether or not correction is possible, as shown in the table below. For details on how to read the LED display, refer to the collective indications label on the reverse side of the top plate or the service manual.

If self-correction is not possible, check the indoor unit wiring and piping in the usual manner.

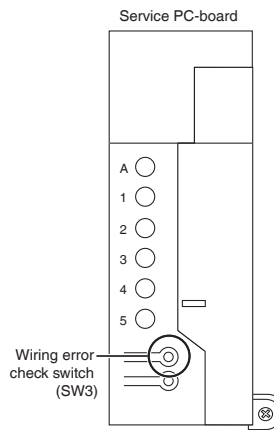

LED	1	2	3	4	Message
Status	All Flashing				Automatic correction impossible
	Flashing One after another				Automatic correction completed
	☀ (One or more of LEDs 1 to 4 are ON)				Abnormal stop [Note. 3]

Wiring correct example

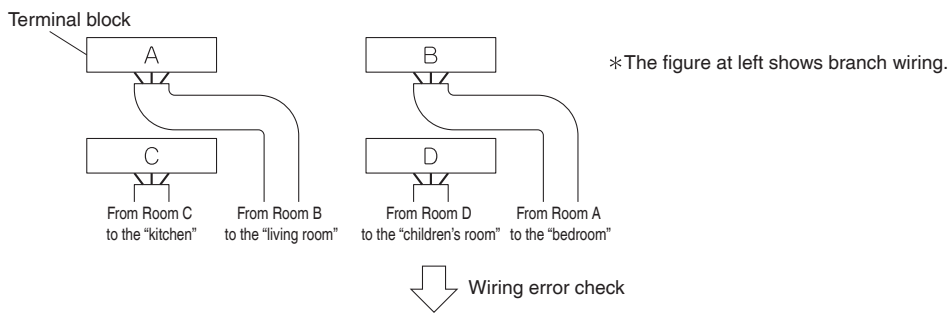

LED lighting sequence after a wiring correction.

Order of LED flashing: 2 → 1 → 3 → 4

NOTE

- 1) For two rooms, LED 3,4 and 5 are not displayed, and for three rooms, LED 4 and 5 are not displayed, and for four rooms, LED 5 is not displayed.
- 2) After wiring error check operation is completed, LED indication will continue until ordinary operation starts. This is normal.
- 3) Follow the product diagnosis procedures. (Details of product error diagnosis are listed on the reverse side of the top plate.)

2. Trial operation and testing

- During the trial operation, first check the operation of each unit individually. After this, check the simultaneous operation of all indoor units. Check both COOL and HEAT operations.

2-1. Measure the supply voltage and make sure that it is within the specified range.

2-2. In COOL operation, select the lowest programmable temperature; in HEAT operation, select the highest programmable temperature.

- When operating the air conditioner in COOL operation in winter, or HEAT operation in summer, activate trial operation mode by following the instructions in the installation manual for the indoor unit.

2-3. Carry out the trial operation following the instructions in the operation manual to ensure that all functions and parts, such as the movement of the flap, are working properly.

- To protect the air conditioner, restart operation is disabled for 3 minutes after the system has been turned off.
- When trial operation is conducted in HEAT operation directly after the circuit breaker is turned on, in some cases no air will be output for about 3 to 20 minutes in order to protect the air conditioner.
- During COOL operation, frost may form on the gas stop valve or other parts. This is normal.

2-4. After running the unit for about 20 minutes, measure the temperatures at the indoor unit inlet and outlet.

- If the measurements are above the values shown in the table below, then they are normal.

	COOL operation	HEAT operation
Temperature difference between inlet and outlet	About 14°F (8°C)	About 36°F (20°C)

(When running in one room)

2-5. After trial operation is complete, set the temperature to a normal level (78°F to 82°F (26°C to 28°C) in COOL operation, 68°F to 75°F (20°C to 24°C) in HEAT operation).

- The air conditioner draws a small amount of power in its standby mode. If the system is not to be used for some time after installation, shut off the circuit breaker to eliminate unnecessary power consumption.
- If the circuit breaker trips to shut off the power to the air conditioner, the system will restore the original operation mode when the circuit breaker is opened again.

3. Test items

Test item	Symptom	Check
Indoor and outdoor units are installed securely.	Fall, vibration, noise	
No refrigerant gas leaks.	Incomplete cooling/heating function	
Refrigerant gas and liquid pipes and indoor drain hose extension are thermally insulated.	Water leakage	
Draining line is properly installed.	Water leakage	
System is properly grounded.	Electrical leakage	
Only specified wires are used for all wiring, and all wires are connected correctly.	No operation or burn damage	
Indoor or outdoor unit's air inlet or air outlet are unobstructed.	Incomplete cooling/heating function	
Stop valves are opened.	Incomplete cooling/heating function	
Pipes and wires are connected to the corresponding terminal blocks/connection ports for the connected unit.	Incomplete cooling/heating function	
The priority room setting is set for only 1 room.	The priority room setting will not function.	
Indoor unit properly receives remote control commands.	No operation	

2.2 5MXS, 4MXL, 4MXLH

Contents

Safety Considerations	1	3. Flaring the pipe end.....	8
Accessories	3	4. Refrigerant piping	9
Precautions for Selecting a Location	3	5. Pressure test and evacuating system.....	10
Precautions on Installation	4	6. Refilling refrigerant	11
Outdoor Unit Installation Diagram	4	7. Charging with refrigerant	11
Outdoor Unit Installation Diagram	4	Wiring	12
Installation Space Requirements	5	Priority Room Setting	14
Selecting a Location for Installation of the Indoor Units	5	Night Quiet Mode setting	15
Connections (connection port)	6	COOL/HEAT mode lock [S15]	15
How to Use Reducers	7	Pump Down Operation	16
Outdoor Unit Installation	8	Trial Operation and Testing	17
1. Installing the outdoor unit	8	1. Wiring error check	17
2. Drain work	8	2. Trial operation and testing	18
		3. Test items	18

The pictures in this document are for illustrative purposes only.

Safety Considerations

Refer also to the General Safety Considerations in the separate booklet.







Read the precautions in this manual carefully before operating the unit.

Read these **Safety Considerations for Installation** carefully before installing an air conditioner or heat pump. After completing the installation, make sure that the unit operates properly during the startup operation.

Instruct the user on how to operate and maintain the unit. Inform users that they should store this installation manual with the operation manual for future reference.

Always use a licensed installer or contractor to install this product. Improper installation can result in water or refrigerant leakage, electric shock, fire, or explosion.

Meanings of **DANGER**, **WARNING**, **CAUTION**, and **NOTE** Symbols:

-  **DANGER**
-  **WARNING**
-  **CAUTION**
-  **NOTE**

-  **DANGER**
- Refrigerant gas is heavier than air and replaces oxygen. A massive leak can lead to oxygen depletion, especially in basements, and an asphyxiation hazard could occur leading to serious injury or death.
- Do not ground units to water pipes, gas pipes, telephone wires, or lightning rods as incomplete grounding can cause a severe shock hazard resulting in severe injury or death. Additionally, grounding to gas pipes could cause a gas leak and potential explosion causing severe injury or death.

- If refrigerant gas leaks during installation, ventilate the area immediately. Refrigerant gas may produce toxic gas if it comes into contact with fire. Exposure to this gas could cause severe injury or death.
- After completing the installation work, check that the refrigerant gas does not leak throughout the system.
- Do not install unit in an area where flammable materials are present due to risk of explosions that can cause serious injury or death.
- Safely dispose all packing and transportation materials in accordance with federal/state/local laws or ordinances. Packing materials such as nails and other metal or wood parts, including plastic packing materials used for transportation may cause injury or death by suffocation.

WARNING

- Only qualified personnel licensed or certified in their jurisdiction must carry out the installation work. Installation must be done in accordance with this installation manual. Improper installation may result in water leakage, electric shock, or fire.
- When installing the unit in a small room, take measures to keep the refrigerant concentration from exceeding allowable safety limits. Excessive refrigerant leaks, in the event of an accident in a closed ambient space, can lead to oxygen deficiency.
- Use only specified accessories and parts for installation work. Failure to use specified parts may result in water leakage, electric shock, fire, or the unit falling.
- Install the air conditioner or heat pump on a foundation strong enough that it can withstand the weight of the unit. A foundation of insufficient strength may result in the unit falling and causing injuries.
- Take into account strong winds, typhoons, or earthquakes when installing. Improper installation may result in the unit falling and causing accidents.
- Make sure that a separate power supply circuit is provided for this unit and that all electrical work is carried out by qualified personnel licensed or certified in their jurisdiction according to local, state, and national regulations. An insufficient power supply capacity or improper electrical construction may lead to electric shock or fire.

- Make sure that all wiring is secured, that specified wires are used, and that no external forces act on the terminal connections or wires. Improper connections or installation may result in fire.
 - When wiring, position the wires so that the shield cover can be securely fastened. Improper positioning of the shield cover may result in electric shock, fire, or the terminals overheating.
 - Before touching electrical parts, turn off the unit.
 - The circuit must be protected with safety devices in accordance with local and national codes, i.e. a circuit breaker.
 - Securely fasten the outdoor unit shield cover. If the shield cover is not installed properly, dust or water may enter the outdoor unit causing fire or electric shock.
 - When installing or relocating the system, keep the refrigerant circuit free from substances other than the specified refrigerant (R410A) such as air. Any presence of air or other foreign substance in the refrigerant circuit can cause an abnormal pressure rise or rupture, which may result in equipment damage and even injury.
 - Do not change the setting of the protection devices. If the pressure switch, thermal switch, or other protection device is shorted and operated forcibly, or parts other than those specified by Daikin are used, fire or explosion may occur.
 - Do not use means to accelerate the defrosting process (if possible) or to clean, other than those recommended by the manufacturer.
 - The appliance must be stored in a room without continuously operating ignition sources (for example: open flames, an operating gas appliance or an operating electric heater).
 - Do not pierce or burn.
 - Be aware that refrigerants may not contain an odor.
 - Comply with national gas regulations.
- (b) Tight -- R410A does not contain any chlorine, does not destroy the ozone layer, and does not reduce the earth's protection against harmful ultraviolet radiation. R410A can contribute to the greenhouse effect if it is released. Therefore take proper measures to check for the tightness of the refrigerant piping installation. Read the chapter *Refrigerant Piping* and follow the procedures.
- Since R410A is a blend, the required additional refrigerant must be charged in its liquid state. If the refrigerant is charged in a state of gas, its composition can change and the system will not work properly.
 - The outdoor unit is for R410A. See the catalog for indoor models that can be connected. Normal operation is not possible when connected to non-compatible indoor units.
 - Remote controller (wireless kit) transmitting distance can be shorter than expected in rooms with electronic fluorescent lamps (inverter or rapid start types). Install the indoor unit far away from fluorescent lamps as much as possible.
 - Indoor units are for indoor installation only. Outdoor units can be installed either outdoors or indoors.
 - Do not install the air conditioner or heat pump in the following locations:
 - (a) Where a mineral oil mist or oil spray or vapor is produced, for example, in a kitchen. Plastic parts may deteriorate and fall off or result in water leakage.
 - (b) Where corrosive gas, such as sulfurous acid gas, is produced. Corroding copper pipes or soldered parts may result in refrigerant leakage.
 - (c) Near machinery emitting electromagnetic waves. Electromagnetic waves may disturb the operation of the control system and cause the unit to malfunction.
 - (d) Where flammable gas may leak, where there is carbon fiber, or ignitable dust suspension in the air, or where volatile flammables such as thinner or gasoline are handled. Operating the unit in such conditions can cause a fire.
 - Take adequate measures to prevent the outdoor unit from being used as a shelter by small animals. Small animals making contact with electrical parts can cause malfunctions, smoke, or fire. Instruct the user to keep the area around the unit clean.
 - Servicing shall be performed only as recommended by the manufacturer and licensed or certified in their jurisdiction.

CAUTION

- Do not touch the switch with wet fingers. Touching a switch with wet fingers can cause electric shock.
- Do not allow children to play on or around the unit to prevent injury.
- Wear adequate personal protective equipment (protective gloves, safety glasses,...) when installing, maintaining or servicing the system.
- The heat exchanger fins are sharp enough to cut. To avoid injury, wear gloves or cover the fins while working around them.
- Do not touch the refrigerant pipes during and immediately after operation as the refrigerant pipes may be hot or cold, depending on the condition of the refrigerant flowing through the refrigerant piping, compressor, and other refrigerant cycle parts. Your hands may suffer burns or frostbite if you touch the refrigerant pipes. To avoid injury, give the pipes time to return to normal temperature or, if you must touch them, be sure to wear proper gloves.
- Install drain piping to ensure proper drainage. Improper drain piping may result in water leakage and property damage.
- Insulate piping to prevent condensation.
- Be careful when transporting the product.
- Do not turn off the power immediately after stopping operation. Always wait for at least 5 minutes before turning off the power. Otherwise, water leakage may occur.
- Do not use a charging cylinder. Using a charging cylinder may cause the refrigerant to deteriorate.
- Refrigerant R410A in the system must be kept clean, dry, and tight.
 - (a) Clean and Dry -- Foreign materials (including mineral oils such as SUNISO oil or moisture) should be prevented from getting into the system.



NOTE

- The outdoor unit should be positioned where the unit and power supply wires (breaker panel to outdoor unit) are at least 10ft (3m) away from any televisions or radios. (The unit may cause interference with the picture or sound.) Depending on the radio waves, a distance of 10ft (3m) may not be sufficient to eliminate the noise.
- Dismantling the unit, treatment of the refrigerant, oil and additional parts must be done in accordance with the relevant local, state, and national regulations.
- Only use tools for R410A, such as a gauge manifold, charge hose, gas leak detector, reverse flow check valve, refrigerant charge base, vacuum gauge, or refrigerant recovery equipment.
- If the conventional refrigerant and refrigerant oil are mixed in R410A, the refrigerant may deteriorate.
- This air conditioner or heat pump is an appliance that should not be accessible to the general public.
- As maximum allowable pressure is 604psi (4.17MPa), the wall thickness of field-installed pipes should be selected in accordance with the relevant local, state, and national regulations.

RN006-U

2

Accessories

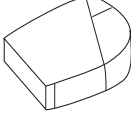
<p>Ⓐ Installation manual</p>	<p>1</p>	<p>Ⓑ Drain socket</p> 	<p>Ⓒ Drain socket cap</p> 	<p>1</p>
<p>Ⓓ Drain plug</p> 	<p>9</p>	<p>Ⓔ Reducer assy</p> 	<p>Ⓕ Warranty</p>	<p>1</p>
			<p>Ⓖ General safety consideration</p>	<p>1</p>

Precautions for Selecting a Location

- 1) Choose a place solid enough to bear the weight and vibration of the unit, where the operating sound will not be amplified.
- 2) Choose a location where the air discharged from the unit or the operating sound will not cause a nuisance to the neighbors of the user.
- 3) Avoid locations, such as near bedrooms, where the operating sound may cause disturbance.
- 4) There must be sufficient space to carry the unit into and out of the site.
- 5) There must be sufficient space for air passage and no obstructions around the air inlet and the air outlet.
- 6) The site must not be prone to flammable gas leaks in the surrounding area.
- 7) In coastal areas or other places with a salty atmosphere or one containing sulfate gas, corrosion may shorten the life of the air conditioner.
- 8) Since water will flow from the drain of the outdoor unit, do not place anything under the unit which must be kept away from moisture.
- 9) A location where flammable gas does not leak. Position at least 6-5/8ft (2m) from propane gas cylinders.

NOTE

Cannot be installed suspended from a ceiling or stacked.

⚠ CAUTION

When operating the air conditioner in a low outdoor ambient temperature, be sure to follow the instructions described below.

- To prevent exposure to wind, install the outdoor unit with its suction side facing the wall.
- Never install the outdoor unit at a site where the suction side may be exposed directly to wind.
- To prevent exposure to wind, it is recommended to install a baffle plate on the air discharge side of the outdoor unit.
- In heavy snow areas, select an installation site where the snow will not affect the unit.
- If there is a likelihood of snow accumulating on the outdoor unit, attach a snow protection hood.
- In high humidity areas or heavy snow areas, it is recommended to attach a drain pan heater to prevent ice build-up from the bottom frame.

- Construct a large canopy.
- Construct a pedestal.



Install the unit high enough off the ground to prevent burying in snow.

Precautions on Installation

- Check the strength and level of the installation surface so that the unit does not cause any operating vibrations or noise after installation.
- Fix the unit in place securely using foundation bolts, as in the figure. (Prepare 4 sets of 1/2 inch (M12) foundation bolts, nuts and washers; all sold separately.)
- It is best to screw in the foundation bolts until their ends are 3/4 inch (20mm) from the foundation surface.

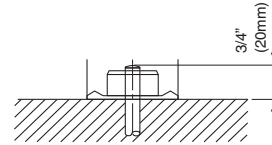

Outdoor Unit Installation Diagram

⚠ CAUTION

- Do not connect the embedded branch piping and the outdoor unit when only carrying out piping work without connecting the indoor unit in order to add another indoor unit later.
Make sure no dirt or moisture gets into either side of the embedded branch piping.
Refer to "4. Refrigerant piping" on page 9 for details.
- It is not possible to have only 1 indoor unit connected. **Be sure to connect at least 2 indoor units.**

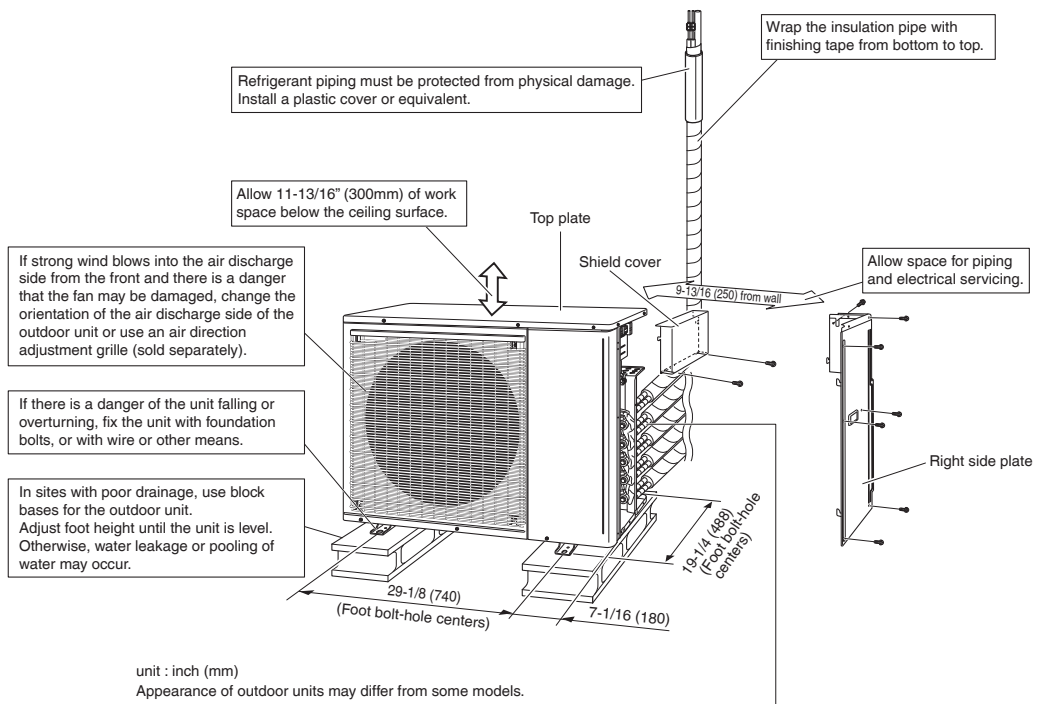

Also insulate the connection on the outdoor unit.

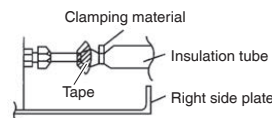

Use tape or insulating material on all connections to prevent air from getting in between the copper piping and the insulation tube. Be sure to do this if the outdoor unit is installed at a higher elevation than any of the indoor units connected to it.

Installation Space Requirements

- Position the unit on a horizontal surface. Any tilt in the unit should be 3° or less to the horizontal.
- Where a wall or other obstacle is in the path of outdoor unit's intake or exhaust airflow, follow the installation space requirements below.
- For any of the below installation patterns, the wall height on the outlet side should be 47-1/4 inch (1200mm) or less.
- Secure as much installation space around the unit as the location allows, as more space will result in more efficient operation.

Wall facing one side

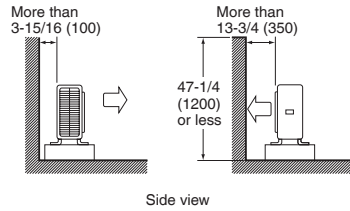

Walls facing two sides

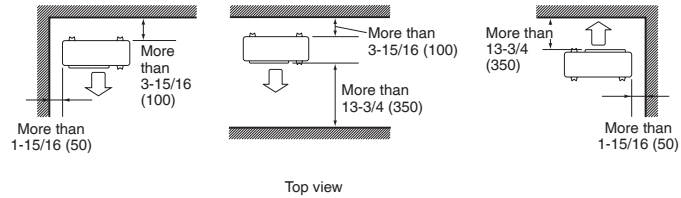

Walls facing three sides

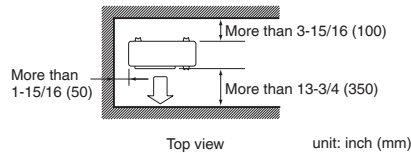

When installed as in the figure on the left, it is recommended to either change the orientation of the outdoor unit outlet side or use the air direction adjustment grille (sold separately).

Selecting a Location for Installation of the Indoor Units

- The maximum allowable length of refrigerant piping, and the maximum allowable height difference between the outdoor and indoor units, are listed below.
- Refrigerant piping must be kept to a minimum.
The suggested shortest pipe length per room is 10ft (3m), in order to avoid noise from the outdoor unit and vibration. (Mechanical noise and vibration may occur depending on how the unit is installed and the environment in which it is used.)

Outdoor unit capacity class	4MXL*	5MXS*
Piping to each indoor unit	98ft (30m) max. 10ft (3m) min.	
Total length of piping between all units	230ft (70m) max.	262ft (80m) max.

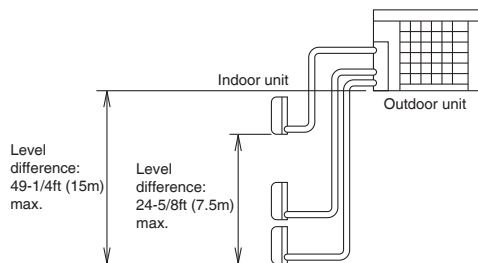

If the outdoor unit is positioned higher than the indoor units.

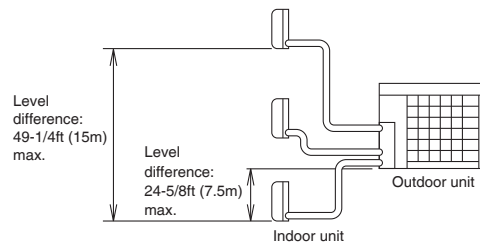

If the outdoor unit is positioned lower than one or more indoor units.

Connections (connection port)

Install the indoor unit according to the table below, which shows the relationship between the class of indoor unit and the corresponding port.

The total indoor unit class that can be connected to this unit:

4MXL* – Up to 48000 Btu

5MXS* – Up to 58000 Btu

The line set piping size is determined by the size of the indoor unit fittings.

Reducers are used at the outdoor unit to accommodate the correct gas line pipe size.

Port	4MXL*	5MXS*
A	07, 09, 12	07, 09, 12
B	# [○] 07, # [○] 09, # [○] 12, 15, 18	# [○] 07, # [○] 09, # [○] 12, 15, 18
C	# [○] 07, # [○] 09, # [○] 12, 15, 18	# [○] 07, # [○] 09, # [○] 12, 15, 18
D	△ [□] 07, △ [□] 09, △ [□] 12, □ [□] 15, □ [□] 18, 24	△ [□] 07, △ [□] 09, △ [□] 12, □ [□] 15, □ [□] 18, 24
E	—	△ [□] 07, △ [□] 09, △ [□] 12, □ [□] 15, □ [□] 18, 24

○ : Use a reducer to connect pipes.

□ : Use No. 1 and 3 reducers

: Use No. 2 and 4 reducers

△ : Use No. 5 and 6 reducers

Refer to "How to Use Reducers" on page 7 for information on reducer numbers and their shapes.

How to Use Reducers

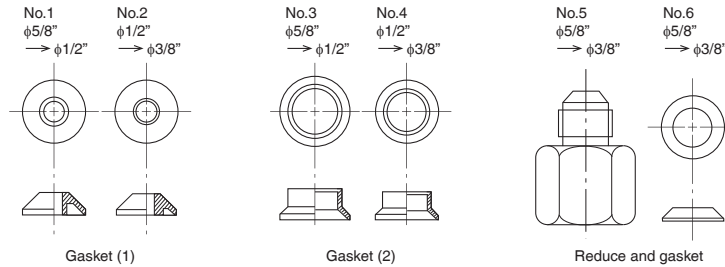

- Use the reducers supplied with the unit as described below.

(1) Connecting a pipe of $\phi 1/2$ inch (12.7mm) to a gas pipe connection port for $\phi 5/8$ inch (15.9mm) :

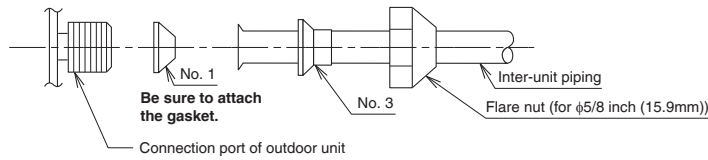

(2) Connecting a pipe of $\phi 3/8$ inch (9.5mm) to a gas pipe connection port for $\phi 1/2$ inch (12.7mm) :

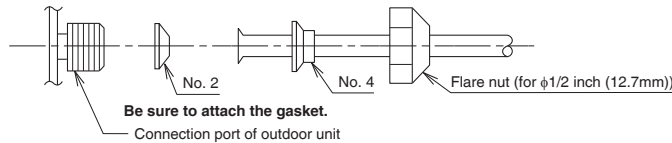

(3) Connecting a pipe of $\phi 3/8$ inch (9.5mm) to a gas pipe connection port for $\phi 5/8$ inch (15.9mm) :

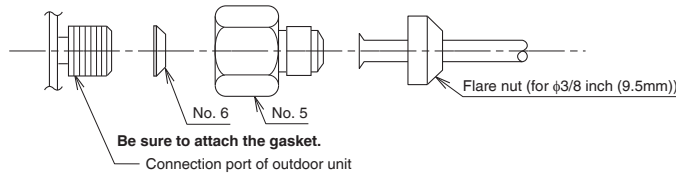

- When using the reducer packing shown above, be careful not to overtighten the nut, or the smaller pipe may become damaged. (Apply about 2/3 to 3/3 the normal torque.)
- Apply a coat of refrigeration oil to the threaded connection port of the outdoor unit where the flare nut comes in.
- Use an appropriate wrench to avoid damaging the connection thread by overtightening the flare nut.

Piping size	Flare nut tightening torque
O.D. $\phi 3/8$ inch (9.5mm)	24-1/8 – 29-1/2 lbf • ft (32.7-39.9N • m)
O.D. $\phi 1/2$ inch (12.7mm)	36-1/2 – 44-1/2 lbf • ft (49.5-60.3N • m)
O.D. $\phi 5/8$ inch (15.9mm)	45-5/8 – 55-5/8 lbf • ft (61.8-75.4N • m)

Outdoor Unit Installation

1. Installing the outdoor unit

- When installing the outdoor unit, refer to “Precautions for Selecting a Location” on page 3 and the “Outdoor Unit Installation Diagram” on page 4.
- If drain work is necessary, follow the procedures below.

2. Drain work

⚠ CAUTION

- In cold areas, do not use a drain socket, drain plugs and a drain hose with the outdoor unit. (Drain water may freeze, impairing heating performance.)

- If the drain port is covered by a mounting base or floor surface, place additional foot bases of at least 3-15/16 inch (100mm) in height under the outdoor unit's feet.
- 1) Insert the ① drain plug into the bottom frame until it is flush with the bottom frame around the entire circumference, as shown in area A.

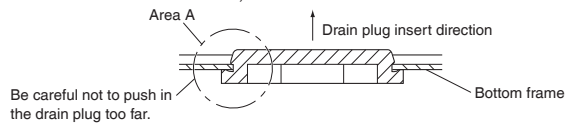

- 2) Insert ② drain socket cap onto ③ drain socket beyond the projection around ③ drain socket.
- 3) Insert ④ drain socket into the matching drain hole. After insertion, turn it about 40° clockwise.

NOTE

Check that ② drain socket cap is correctly engaged with the projection of ③ drain socket. Otherwise, water leakage may result.

- 4) Connect the drain hose (field supplied; internal diameter of 1 inch (25mm)) to ④ drain socket. (Ensure there are no bends in the hose if it is too long or hangs down.)
- 5) Make sure the ① drain plugs and the ④ drain socket of the outdoor unit are securely inserted and there is no leakage.

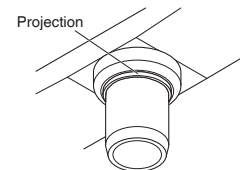
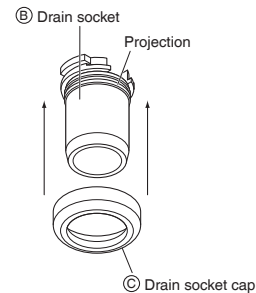
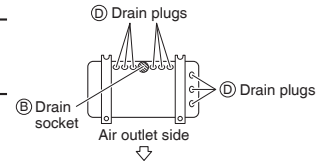

3. Flaring the pipe end

⚠ WARNING

- Do not apply mineral oil to the flare.
- Prevent mineral oil from getting into the system as this would reduce the service life of the units.
- Never use piping which has been used for previous installations. Only use parts which are delivered with the unit.
- Never install a dryer to this R410A unit in order to guarantee its service life.
- The drying material may dissolve and damage the system.
- Improper flaring may result in refrigerant gas leakage.

⚠ CAUTION

Do not reuse joints which have been used once already.

- 1) Cut the pipe end with a pipe cutter.
- 2) Remove burrs with the cut surface facing downward so that the filings do not enter the pipe.
- 3) Put the flare nut on the pipe.
- 4) Flare the pipe.
- 5) Check that the flaring has been done correctly.

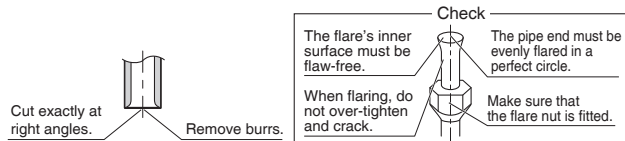

Set exactly at the position shown below.		Flaring		
		Flare tool for R410A		Conventional flare tool
		Clutch-type	Clutch-type (Rigid-type)	Wing-nut type (Imperial-type)
A	0-0.020 inch (0-0.5mm)	0.039-0.059 inch (1.0-1.5mm)	0.059-0.079 inch (1.5-2.0mm)	

Outdoor Unit Installation

4. Refrigerant piping

⚠ CAUTION

- Use the flare nut fixed to the main unit. (This is to prevent the flare nut from cracking as a result of deterioration over time.)
- To prevent gas leakage, apply refrigeration oil only to the inner surface of the flare. (Use refrigeration oil for R410A.)
- Use a torque wrench when tightening the flare nuts to prevent damage to the flare nuts and gas leakage.

- Align the centers of both flares and tighten the flare nuts 3 or 4 turns by hand, then tighten them fully with a spanner and a torque wrench.

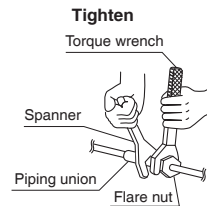
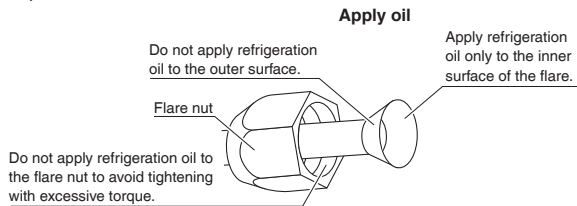

Tightening torque

Piping connection

Flare nut			
Gas side		Liquid side	
3/8 inch (9.5mm)	1/2 inch (12.7mm)	5/8 inch (15.9mm)	1/4 inch (6.4mm)
24-1/8 – 29-1/2lbf • ft (32.7-39.9N • m)	36-1/2 – 44-1/2lbf • ft (49.5-60.3N • m)	45-5/8 – 55-5/8lbf • ft (61.8-75.4N • m)	10-1/2 – 12-3/4lbf • ft (14.2-17.2N • m)

Valve cap

Width across flats	
3/4 inch (19mm)	7/8 inch (22mm)
12-5/8 – 15-3/8lbf • ft (17.0-21.0N • m)	16-1/4 – 19-7/8lbf • ft (22.0-27.0N • m)

Service port cap

8 – 10-7/8lbf • ft (10.7-14.7N • m)
--

Cautions on pipe handling

- Protect the open end of the pipe from dust and moisture.
- All pipe bends should be as gentle as possible. Use a pipe bender for bending.

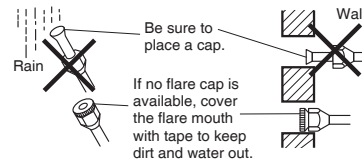

Selection of copper and heat insulation materials

When using commercial copper pipes and fittings, observe the following:

- Insulation material: Polyethylene foam
Heat transfer rate: 0.041 to 0.052W/mK (0.024 to 0.030Btu/fth°F)
(0.035 to 0.045kcal/mh°C)
Be sure to use insulation that is designed for use with HVAC Systems.
- ACR Copper only.
- Be sure to insulate both the gas and liquid piping and observe the insulation dimensions as below.

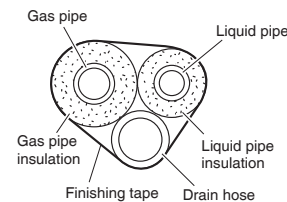

	Piping size	Minimum bend radius	Piping thickness	Thermal insulation size	Thermal insulation thickness
Gas side	O.D. 3/8 inch (9.5mm)	1-3/16 inch (30mm) or more	0.031 inch (0.8mm) (C1220T-O)	I.D. 15/32-19/32 inch (12-15mm)	13/32 inch (10mm) Min.
	O.D. 1/2 inch (12.7mm)	1-9/16 inch (40mm) or more		I.D. 9/16-5/8 inch (14-16mm)	
	O.D. 5/8 inch (15.9mm)	1-15/16 inch (50mm) or more		I.D. 5/8-13/16 inch (16-20mm)	
Liquid side	O.D. 1/4 inch (6.4mm)	1-3/16 inch (30mm) or more	0.031 inch (0.8mm) (C1220T-O)	I.D. 5/16-13/32 inch (8-10mm)	

- Use separate thermal insulation pipes for gas and liquid refrigerant pipes.
- Using finishing tape, bundle and wrap the indoor unit piping and drain hose together so that the drain hose is below the other piping.

5. Pressure test and evacuating system

⚠ WARNING

- Make sure that air or any matter other than refrigerant (R410A) does not get into the refrigeration cycle.
- If refrigerant gas leaks should occur, ventilate the room as soon and as much as possible.
- R410A, as well as other refrigerants, should always be recovered and never be released directly into the environment.
- Use a vacuum pump for R410A exclusively. Using the same vacuum pump for different refrigerants may damage the vacuum pump or the unit.

⚠ CAUTION

It is highly recommended that you do not open/close the stop valves when the outdoor temperature is below -5°F (-21°C) as this may result in refrigerant leakage.

- When piping work is complete, it is necessary to perform a pressure test and evacuate system with a vacuum pump.
- If using additional refrigerant, purge the air from the refrigerant pipes and indoor unit using a vacuum pump, then charge additional refrigerant.
- Use a hexagonal wrench (3/16 inch (4mm)) to operate the stop valve rods.
- All refrigerant pipe joints should be tightened with a torque wrench to the specified tightening torque.

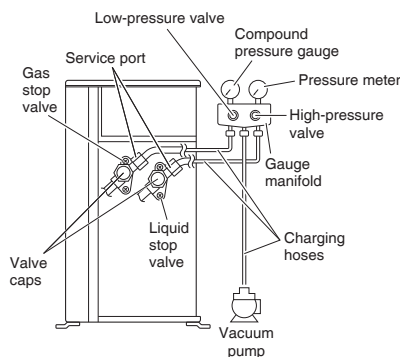

- 1) Pressurize the liquid pipe and gas pipe from the service ports of each stop valve to 604psi (4.17MPa) (do not pressurize more than 604psi (4.17MPa)) for 1 hour minimum, 24 hours recommended. If there is a pressure drop, check for leaks, make repairs and perform the pressure test again.
- 2) Connect the gauge manifold's charging hoses to the service ports of each stop valve.
- 3) Fully open the low-pressure valve (Lo) and the high-pressure valve (Hi) on the gauge manifold.
- 4) Evacuate system using vacuum pump to below 500 microns for 1 hour minimum.
- 5) Close the low-pressure valve (Lo) and the high-pressure valve (Hi) on the gauge manifold and stop vacuum pump. (Maintain this condition for 4-5 minutes to make sure that the compound pressure gauge pointer does not swing back.)*1
- 6) Remove the valve caps from the liquid stop valve and gas stop valve.
- 7) To open the liquid stop valve, turn the rod of the valve 90° counter-clockwise using a hexagonal wrench. Close it after 5 seconds, and check for gas leakage. Using soapy water, check for gas leakage from the indoor unit's flare and outdoor unit's flare and valve rods. After the check is complete, wipe all soapy water off.
- 8) Disconnect the charging hoses from the service ports, then fully open the liquid and gas stop valves. (Do not attempt to turn the valve rods further than they can go.)
- 9) Tighten the valve caps and service port caps for the liquid and gas stop valves with a torque wrench to the specified torques. Refer to "4. Refrigerant piping" on page 9 for details.

*1 If the compound pressure gauge pointer swings back, the refrigerant may have water content or there may be a loose pipe joint. Check all pipe joints and retighten nuts as needed, then repeat steps 3) through 5).

Outdoor Unit Installation

6. Refilling refrigerant

Check the type of refrigerant to be used on the machine nameplate.

Precautions when adding R410A

Fill from the liquid pipe in liquid form.

R410A is a mixed refrigerant, so adding it in gas form may cause the refrigerant composition to change, preventing normal operation.

- 1) Before filling, check whether the cylinder has a siphon attached or not. (It should have something like “liquid filling siphon attached” displayed on it.)

Filling a cylinder with an attached siphon



Stand the cylinder upright when filling.

(There is a siphon pipe inside, so the cylinder need not be upside-down to fill with liquid.)

Filling other cylinders



Turn the cylinder upside-down when filling.

- Be sure to use the R410A tools to ensure pressure and to prevent foreign objects from entering.

7. Charging with refrigerant

⚠ CAUTION

Even though the stop valve is fully closed, the refrigerant may slowly leak out; do not leave the flare nut removed for a long period of time.

- If the total length of piping for all rooms exceeds the figure listed below, additionally charge with 0.21oz/ft (20g/m) of refrigerant (R410A) for each additional piping length. Be sure to add the proper amount of additional refrigerant. Failure to do so may result in reduced performance.

Outdoor unit capacity class	5MXS*, 4MXL*
Total length of piping for all rooms	131-1/4ft (40m)

Wiring

⚠ WARNING

- Do not ground units to water pipes, gas pipes, telephone wires, or lightning rods as incomplete grounding can cause a severe shock hazard resulting in severe injury or death. Additionally, grounding to gas pipes could cause a gas leak and potential explosion causing severe injury or death.
- Do not use tapped wires, extension cords, or starburst connections, as they may cause overheating, electric shock, or fire.
- Do not use locally purchased electrical parts inside the product. (Do not branch the power for the drain pump, etc., from the terminal block.) Doing so may cause electric shock or fire.
- The circuit must be protected with safety devices in accordance with local and national codes, i.e. a circuit breaker.
- Use an all-pole disconnection type circuit breaker with at least 1/8 inch (3mm) between the contact point gaps.
- When carrying out wiring, take care not to pull at the conduit.
- Do not connect the power wire to the indoor unit. Doing so may cause electric shock or fire.
- Do not turn on the circuit breaker until all work is completed.

⚠ CAUTION

Precautions to be taken for power supply wiring

Recommend stranded cable for interunit wiring. Local code always supersedes recommendation.

- For stranded wires, make sure to use the round crimp-style terminal for connection to the power supply terminal block. Place the round crimp-style terminals on the wires up to the covered part and secure in place.

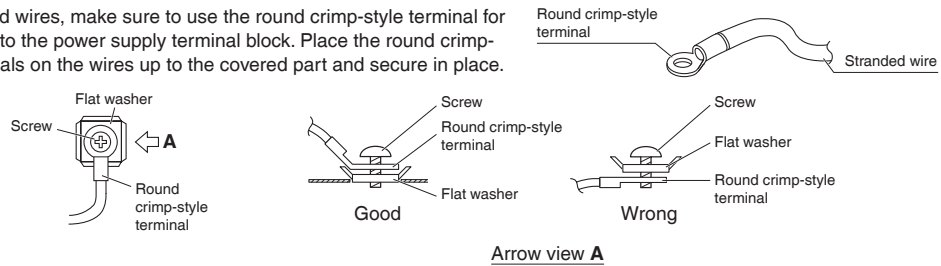

- If solid core wire must be used, be sure to curl the end of the lead. Improper work may cause heat and fire.

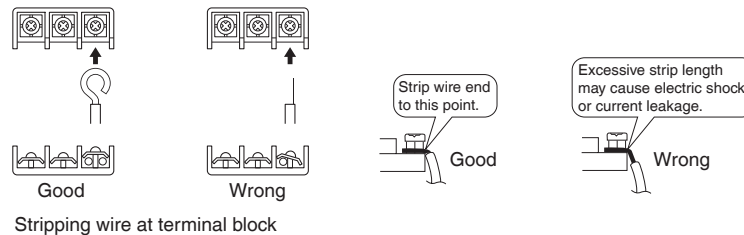

Wiring

[Method of Mounting Conduit]

• When connecting indoor units for 3 rooms or more, open knockout holes without deforming the conduit mounting plate.

- 1) Remove the right side plate (7 screws).
- 2) Remove the shield cover (2 screws).
- 3) Pass wires through the conduit and secure them with a lock nut.

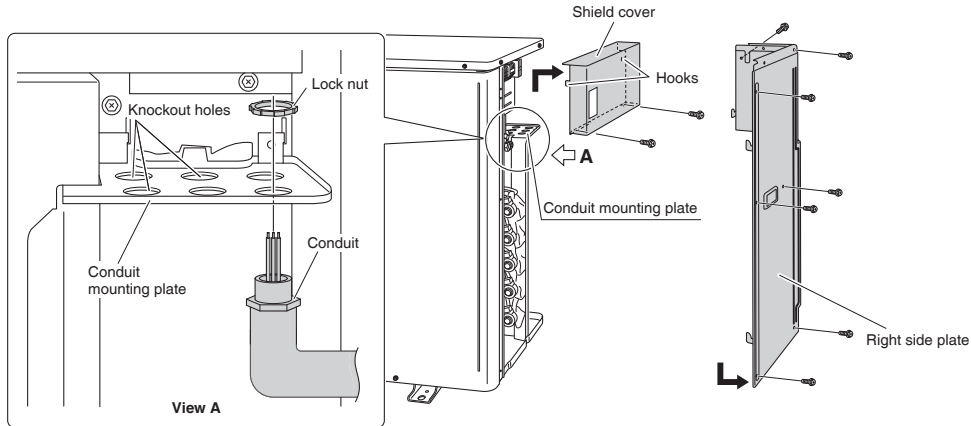

[Wiring procedure]

- 1) Strip the insulation from the wire (3/4 inch (20mm)).
- 2) Connect the inter-unit wires between the indoor and outdoor units **so that the terminal numbers match**. Tighten the terminal screws securely. It is recommended that a slot-head screwdriver be used to tighten the screws.
- 3) **Be sure to match the symbols for wiring and piping.**
- 4) Pull the wire lightly to make sure that it does not disconnect.
- 5) After completing the work, reattach the shield cover and right side plate to their original positions.
 - Attach so that the shield cover hooks (2 locations) are securely engaged.

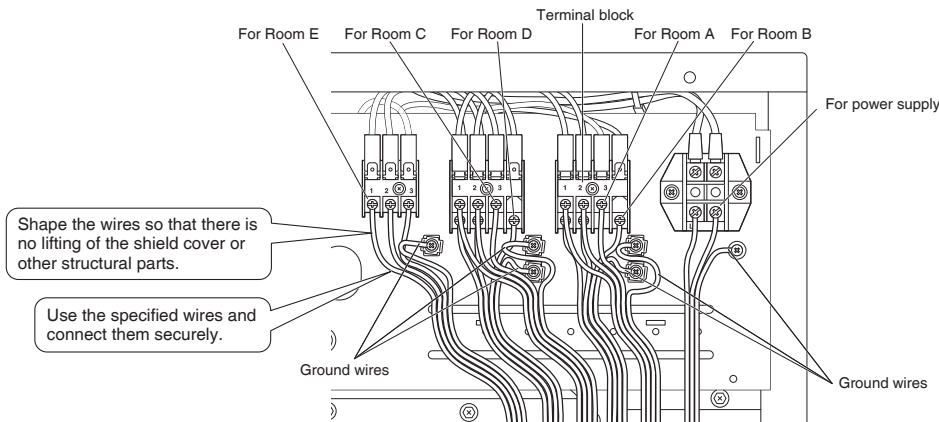
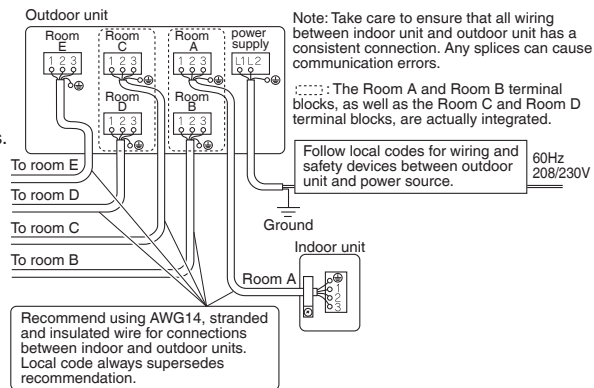

Ground

This air conditioner must be grounded. For grounding, follow all local, and state electrical codes.

Priority Room Setting

- To use priority room setting, initial settings must be made when the unit is installed. Explain the priority room setting, as described below, to the user, and confirm whether or not the user wants to use priority room setting. Setting it in the guest and living rooms is convenient.

About the priority room setting function

The indoor unit for which priority room setting is applied takes priority in the following cases.

1) Operation mode priority

The operation mode of the indoor unit which is set for priority room setting takes priority. If the set indoor unit is operating, all other indoor units do not operate and enter standby mode, according to the operation mode of the set indoor unit.

2) Priority during powerful operation

If the indoor unit which is set for priority room setting is operating at powerful, the capabilities of other indoor units will be somewhat reduced. Power supply gives priority to the indoor unit which is set for priority room setting.

3) Quiet operation priority

Setting the indoor unit to quiet operation will make the outdoor unit run quietly.

Setting procedure

Slide the priority room setting switch (SW4) to the on side for the switch that corresponds to the piping connected to the indoor unit to be set.

(In the figure below, it is room A.)

Once the settings are complete, switch the power on.

Be sure to set only one room

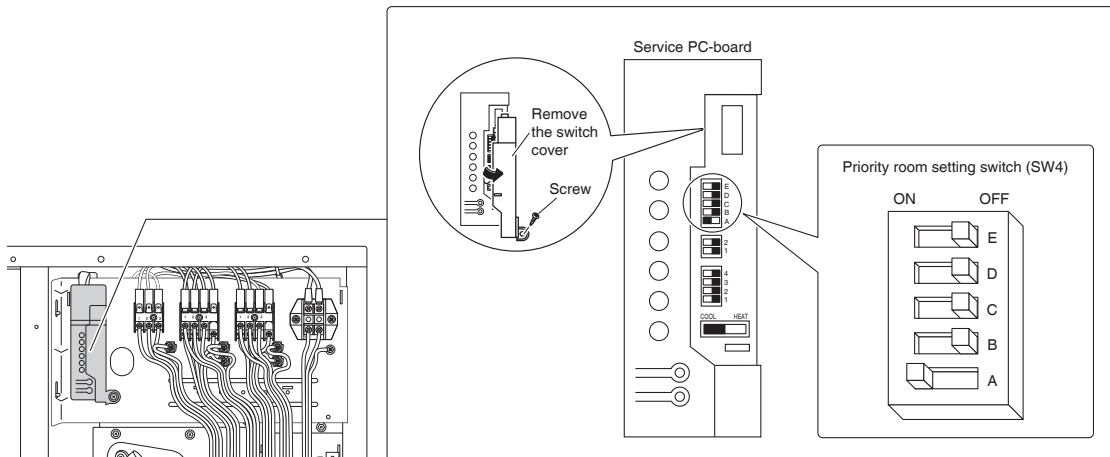

Night Quiet Mode setting

- If night quiet mode is to be used, initial settings must be made when the unit is installed. Explain night quiet mode, as described below, to the user, and confirm whether or not the user wants to use night quiet mode.

About night quiet mode

The night quiet mode function reduces operating noise of the outdoor unit at nighttime. This function is useful if the user is worried about the effects of the operating noise on the neighbors.

However, cooling capacity will be reduced when operating in night quiet mode.

Setting procedure

Turn the night quiet mode switch (SW6-1) to on.

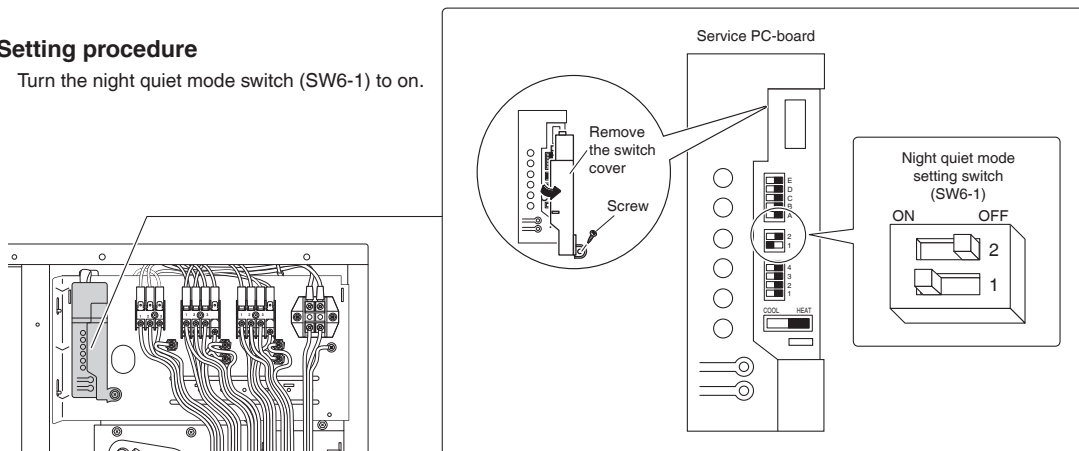

COOL/HEAT mode lock [S15]

- 1) Remove the top plate (10 screws).
- 2) Remove the right side plate (6 screws).
- 3) Remove the front plate (1 screw).
 - The front plate is heavy, so take care.
- 4) Remove the shield plate (2 screws).
- 5) Use the S15 connector to set the unit to only cool or heat.

Setting to only heat (H) : short-circuit pins 1 and 3 of the connector [S15]

Setting to only cool (C) : short-circuit pins 3 and 5 of the connector [S15]

The following specifications apply to the connector housing and pins.

JST products Housing: VHR-5N
Pin: SVH-21T-P1.1

Note that forced operation is also possible in COOL/HEAT mode.

- 6) Reattach the shield plate, front plate, right side plate and top plate to their original positions.
 - Attach so that the shield plate hooks (2 locations) are securely engaged.

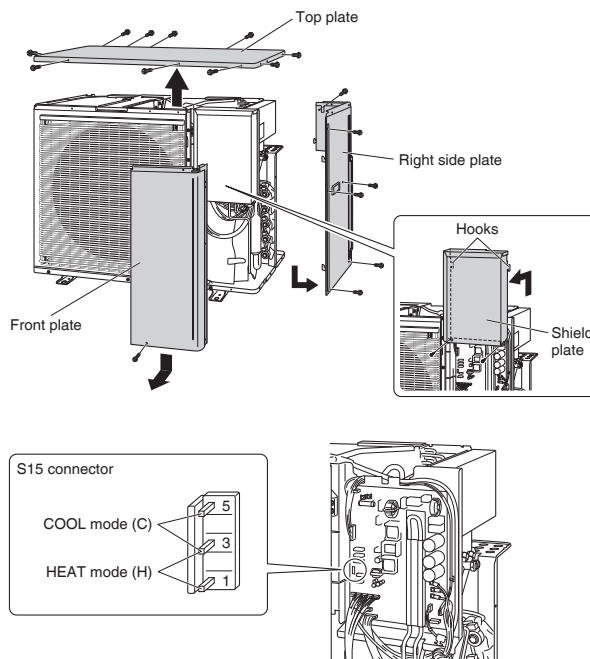

Pump Down Operation

In order to protect the environment, be sure to pump down when relocating or disposing of the unit.

- 1) Remove the valve caps from liquid stop valve and gas stop valve.
- 2) Begin forced cooling operation.
- 3) After 1 to 2 minutes, close the liquid stop valve with a hexagonal wrench.
- 4) After 3 to 4 minutes, close the gas stop valve and stop forced cooling operation.
- 5) Attach the valve caps once procedures are complete.

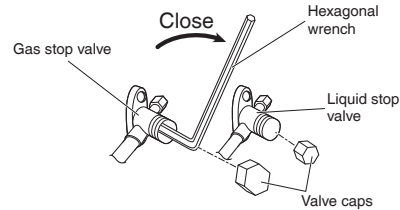

Forced cooling operation

⚠ WARNING

Do not remove the switch cover unless the power has been turned off. (Risk of electric shock)

- 1) Turn off the power.
- 2) Remove the right side plate (6 screws) and the shield cover (2 screws).
- 3) Remove the service PC-board switch cover (1 screw).
- 4) Switch SW5 and SW6 to off.
- 5) Turn the operation mode switch (SW2) to COOL.
- 6) Screw the service PC-board switch cover back on (1 screw).
- 7) Attach the shield cover (2 screws) and the right side plate (6 screws).
- 8) Turn on the power.
- 9) Push the forced operation switch (SW1) above the service PC-board cover. (The operation will start.)
 - Forced cooling operation will stop automatically after about 8 minutes.
 - To stop the operation, push the forced operation switch (SW1) again.

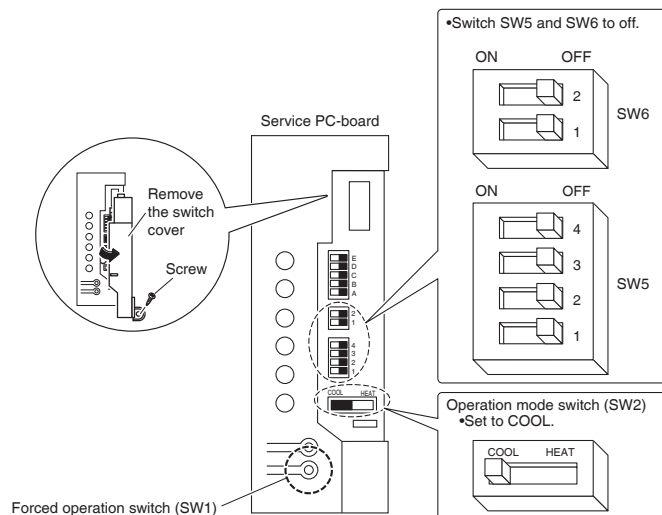

Trial Operation and Testing

- Before starting the trial operation, measure the voltage at the primary side of the circuit breaker.
- Check that all liquid and gas stop valves are fully open.
- Check that piping and wiring all match. The wiring error check can be conveniently used for underground wiring and other wiring that cannot be directly checked. However, if the outside air temperature is **41°F (5°C) or less**, the wiring error check function will not operate.
- When trial operation is conducted directly after the circuit breaker is turned on, in some cases no air will be output for about 15 minutes in order to protect the air conditioner.

1. Wiring error check

This product is capable of automatic correction of wiring errors.

Press the wiring error check switch on the outdoor unit service PC-board. However, the wiring error check switch will not function for 3 minutes after the safety breaker is turned on. About 15-25 minutes after the switch is pressed, the errors in the connection wiring will be corrected.

The service monitor LEDs indicate whether or not correction is possible, as shown in the table below. For details on how to read the LED display, refer to the collective indications label on the reverse side of the right side plate or the service manual.

If self-correction is not possible, check the indoor unit wiring and piping in the usual manner.

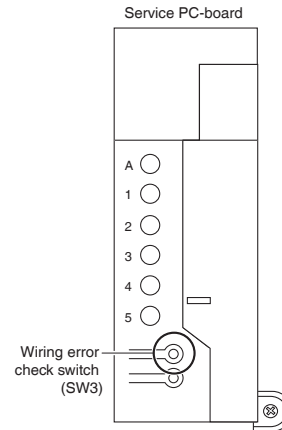

LED	1	2	3	4	5	Message
Status	All Flashing					Automatic correction impossible
	Flashing One after another					Automatic correction completed
	☀ (One or more of LEDs 1 to 5 are ON)					Abnormal stop [Note. 3]

Wiring error example

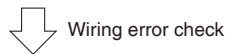
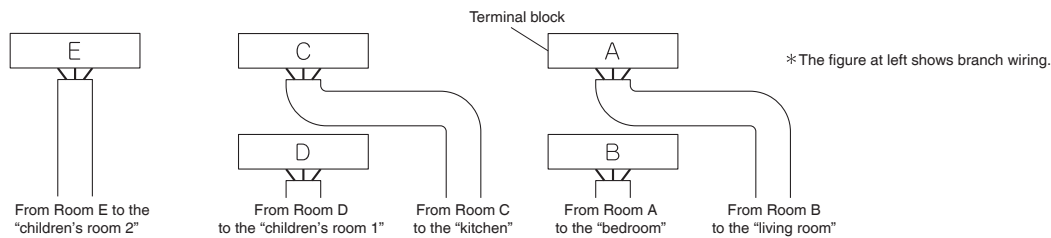

LED lighting sequence after a wiring correction.

Order of LED flashing: 2 → 1 → 3 → 4 → 5

NOTE

- 1) For two rooms, LED 3, 4 and 5 are not displayed, and for three rooms, LED 4 and 5 is not displayed, and for four rooms, LED 5 is not displayed.
- 2) After wiring error check operation is completed, LED indication will continue until ordinary operation starts. This is normal.
- 3) Follow the product diagnosis procedures. (Details of product error diagnosis are listed on the reverse side of the right side plate.)

2. Trial operation and testing

- During the trial operation, first check the operation of each unit individually. After this, check the simultaneous operation of all indoor units. Check both COOL and HEAT operations.

2-1. Measure the supply voltage and make sure that it is within the specified range.

2-2. In COOL operation, select the lowest programmable temperature; in HEAT operation, select the highest programmable temperature.

- When operating the air conditioner in COOL operation in winter, or HEAT operation in summer, activate trial operation mode by following the instructions in the installation manual for the indoor unit.

2-3. Carry out the trial operation following the instructions in the operation manual to ensure that all functions and parts, such as the movement of the flap, are working properly.

- To protect the air conditioner, restart operation is disabled for 3 minutes after the system has been turned off.
- When trial operation is conducted in HEAT operation directly after the circuit breaker is turned on, in some cases no air will be output for about 3 to 20 minutes in order to protect the air conditioner.
- During COOL operation, frost may form on the gas stop valve or other parts. This is normal.

2-4. After running the unit for about 20 minutes, measure the temperatures at the indoor unit inlet and outlet.

- If the measurements are above the values shown in the table below, then they are normal.

	COOL operation	HEAT operation
Temperature difference between inlet and outlet	About 14°F (8°C)	About 36°F (20°C)

(When running in one room)

2-5. After trial operation is complete, set the temperature to a normal level (78°F to 82°F (26°C to 28°C) in COOL operation, 68°F to 75°F (20°C to 24°C) in HEAT operation).

- The air conditioner draws a small amount of power in its standby mode. If the system is not to be used for some time after installation, shut off the circuit breaker to eliminate unnecessary power consumption.

3. Test items

Test item	Symptom	Check
Indoor and outdoor units are installed securely.	Fall, vibration, noise	
No refrigerant gas leaks.	Incomplete cooling/heating function	
Refrigerant gas and liquid pipes and indoor drain hose extension are thermally insulated.	Water leakage	
Draining line is properly installed.	Water leakage	
System is properly grounded.	Electrical leakage	
Only specified wires are used for all wiring, and all wires are connected correctly.	No operation or burn damage	
Indoor or outdoor unit's air inlet or air outlet are unobstructed.	Incomplete cooling/heating function	
Stop valves are opened.	Incomplete cooling/heating function	
Pipes and wires are connected to the corresponding terminal blocks/connection ports for the connected unit.	Incomplete cooling/heating function	
The priority room setting is set for only 1 room.	The priority room setting will not function.	
Indoor unit properly receives remote control commands.	No operation	

3. Remote Controller (Required Option for CDMQ, FDMQ, FFQ)

3.1 BRC1E73

1. Safety Considerations

The original instructions are written in English. All other languages are translations of the original instructions.

All phases of the field-installation, including, but not limited to, electrical, piping, safety, etc. must be in accordance with manufacturer's instructions and must comply with national, state, provincial and local codes.



Read these **SAFETY CONSIDERATIONS** carefully before installing the remote controller.

After completing the installation, ensure that the remote controller operates properly during the startup operation.

Train the customer to operate and maintain the remote controller. Inform customers that they should store this Installation Manual with the Operation Manual for future reference.

Always use a licensed installer or contractor to install this product. Improper installation can result in electrical shock, fire, or explosion.

Meanings of **WARNING**, **CAUTION**, and **NOTE** Symbols.

 WARNING	Indicates a potentially hazardous situation which, if not avoided, could result in death or serious injury.
 CAUTION	Indicates a potentially hazardous situation which, if not avoided, may result in minor or moderate injury. It may also be used to alert against unsafe practices.
 NOTE	Indicates situations that may result in equipment or property-damage accidents only.

 WARNING
Only qualified personnel must carry out the installation work.
Consult your Daikin dealer regarding relocation and reinstallation of the remote controller. Improper installation work may result in electric shocks or fire.
Electrical work must be performed in accordance with relevant local and national regulations and with instructions in this installation manual. Improper installation may cause electrical shocks or fire.
Use only specified accessories and parts for installation work. Failure to use specified parts may result in electric shocks, fire, or the unit falling.
Do not disassemble, reconstruct, or repair. Electric shock or fire may occur.
Make sure that all wiring is secured, that specified wires are used, and that no external forces act on the terminal connections or wires. Improper connections or installation may result in fire.
Before touching electrical parts, confirm the power-off to the unit.

⚠ CAUTION

Keep water out of the remote controller.

To avoid electric shock due to entry of water or insects, fill the wiring through-hole with putty.

Do not wash the remote controller with water as it may result in electrical shocks or fire.

Do not touch the remote controller buttons with wet fingers.

Touching the buttons with wet fingers can cause an electric shock.

Do not install the remote controller in the following locations:

- (a) Where a mineral oil mist or oil spray or vapor is produced, for example, in a kitchen.
Plastic parts may deteriorate.
- (b) Where corrosive gas, such as sulfurous acid gas, is produced.
- (c) Near machinery emitting electromagnetic waves.
Electromagnetic waves may disturb the operation of the control system and cause the unit to malfunction.
- (d) Where flammable gas may leak, where there is carbon fiber or ignitable dust suspensions in the air, or where volatile flammables such as thinner or gasoline are handled.
Operating the unit in such conditions can cause a fire.
- (e) High temperature area or direct flame.
Overheating and/or fire can occur.
- (f) Moist area, where there is exposure to water. If water enters the inside of the remote controller, it may cause electric shock and electrical components may fail.

⚠ NOTE







Install the control wires for the indoor and the remote controller at least 3.5 feet (1 meter) away from televisions or radios to prevent image interference or noise. Depending on the radio waves, a distance of 3.5 feet (1 meter) may not be sufficient to eliminate the noise.

When remote controller's temperature sensor is used, select the installation location as per the following:

- A place where average temperature in the room can be detected.
- A place where it is not exposed to direct sunlight.
- A place where it is far away from any heat source.
- A place where it is not affected directly by outside air.

2. Accessories

The following accessories are included.

Drywall screw	Drywall anchor	Wire tie	Operation manual	Installation manual	Wiring retainer
					
(2 pcs.)	(2 pcs.)	(1 pc.)	(1 pc.)	(1 pc.)	(1 pc.)

3. Remote Controller Installation Procedure

3-1 Determine where to install the remote controller.

Make sure to follow the **Safety Considerations** when determining the location.

3-2 If the control wire for the remote controller is to be routed from the rear, consider the location of the access hole in the lower case for making a hole in the wall.

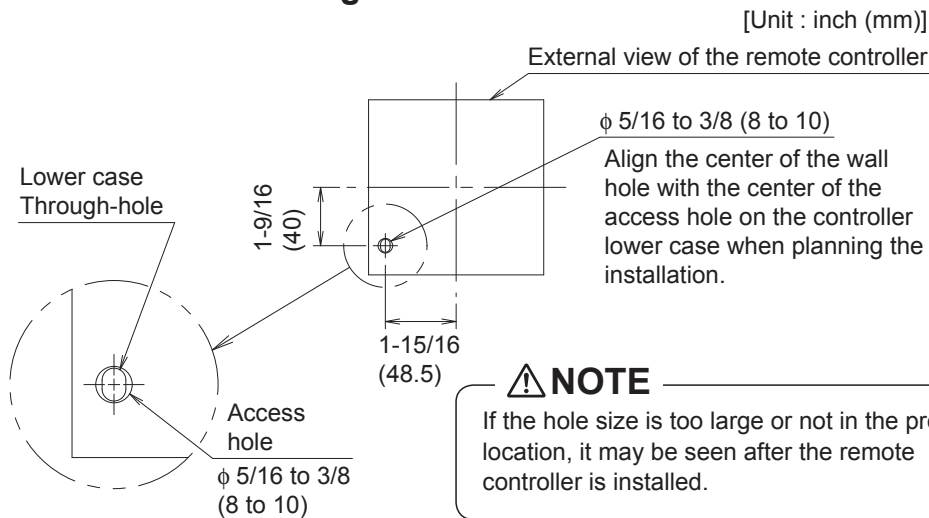

3-3 Remove upper case.

Insert a screwdriver in the recess of lower case to remove the upper case (2 points).

Remote controller printed-circuit board is installed on the upper case. Be careful not to damage the printed-circuit board with the screwdriver.

Be careful not to let dust or moisture touch the printed-circuit board.

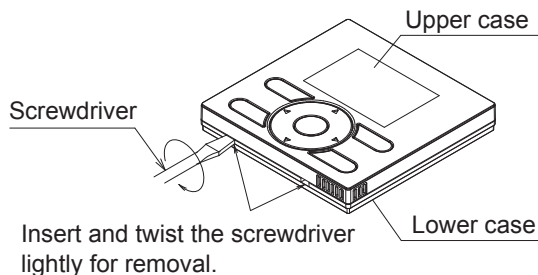

3-4 Determine the location where the wiring will enter the remote controller (back, left side, top left, top center).

3-4-1 Back outlet

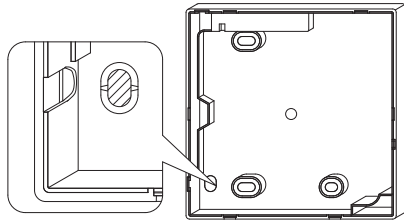

Cut off resin area (notched area).

3-4-2 Left outlet

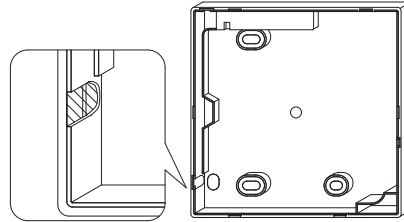

Cut the plastic at the notched area and remove any remaining burrs.

3-4-3 Top left outlet

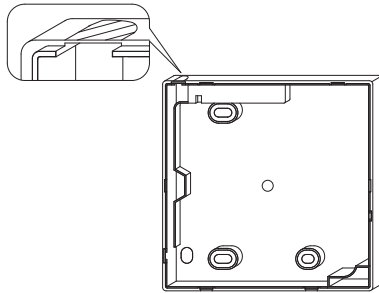

Cut the plastic at the notched area and remove any remaining burrs.

3-4-4 Top center outlet

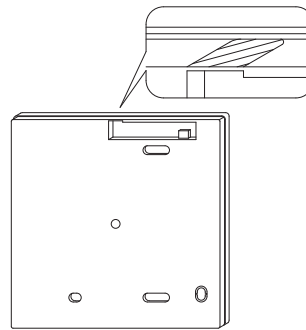

Cut the plastic at the notched area and remove any remaining burrs.

3-5 Install wiring.

⚠ NOTE

1. Switch box and control wiring are field supplied.
2. Do not touch the remote controller printed-circuit board.

Wiring Specifications

Wiring Type	Non-shielded, 2-conductor, stranded copper wire
Wiring Size	AWG-18
Wiring Length	Maximum 1640 feet (500 m)

Prepare the wiring for connection to the remote controller following these instructions:

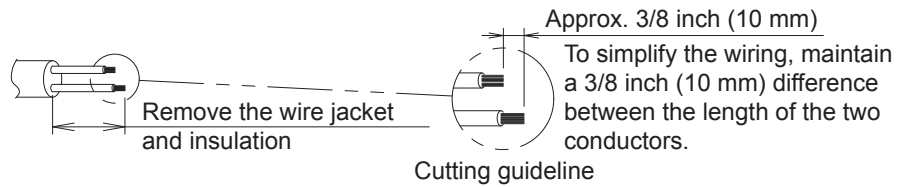

Length of jacket to be removed:

- Approx. 6 inch (150 mm) for top left outlet
- Approx. 8 inch (200 mm) for top center outlet

Connect the terminals (P/P1, N/P2) of the remote controller to the terminals (P1, P2) of the indoor unit. (P1 and P2 are not polarity sensitive.)

3-5-1 Back outlet

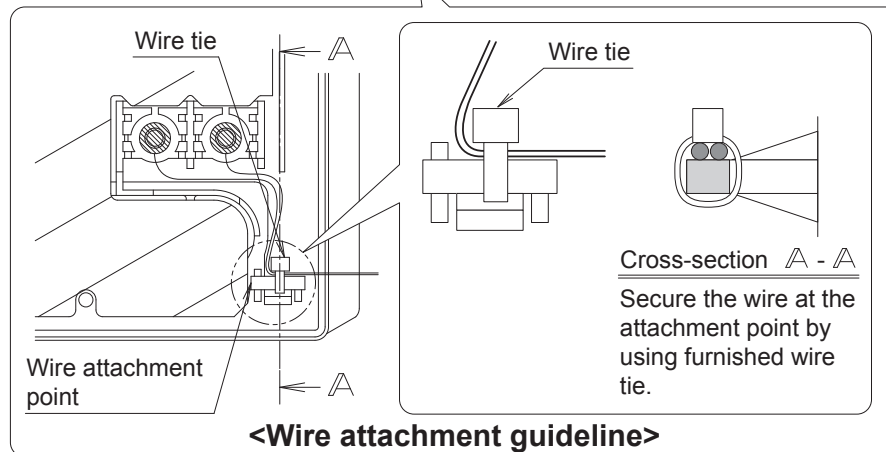
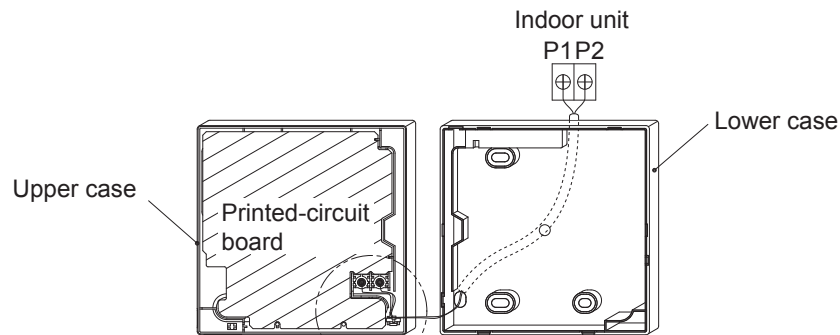

3-5-2 Left outlet

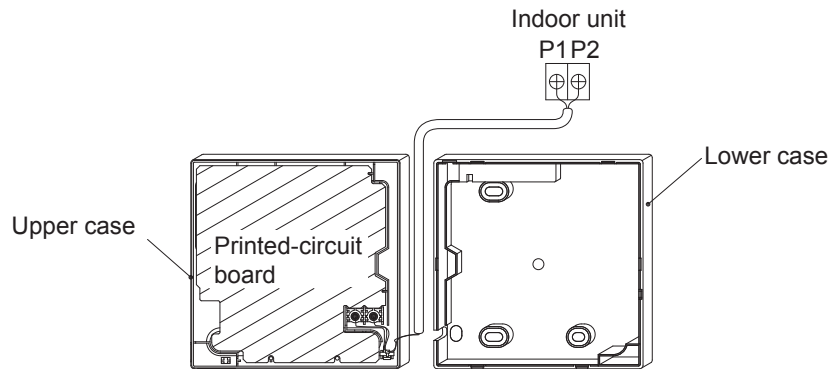

3-5-3 Top left outlet

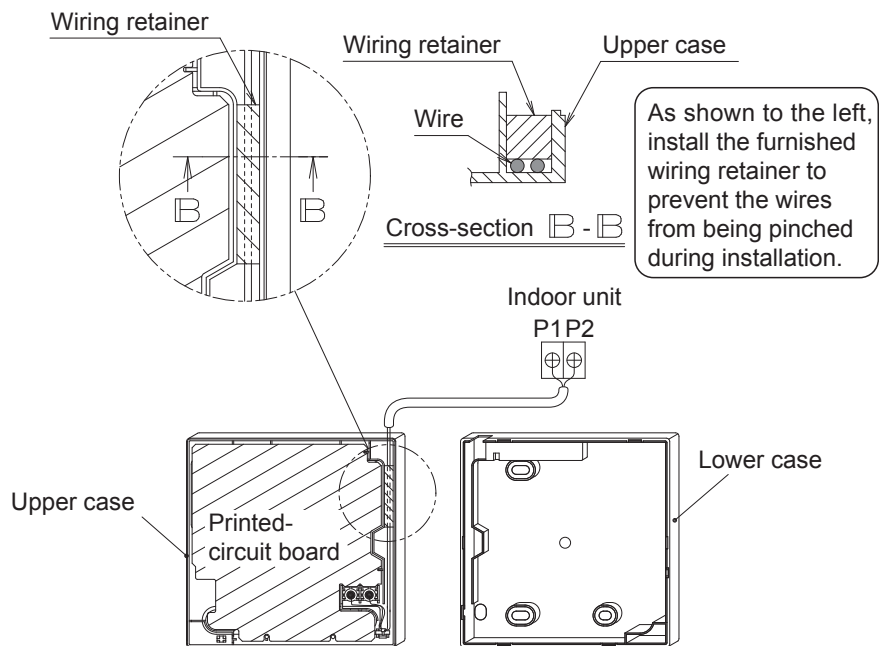

3-5-4 Top center outlet

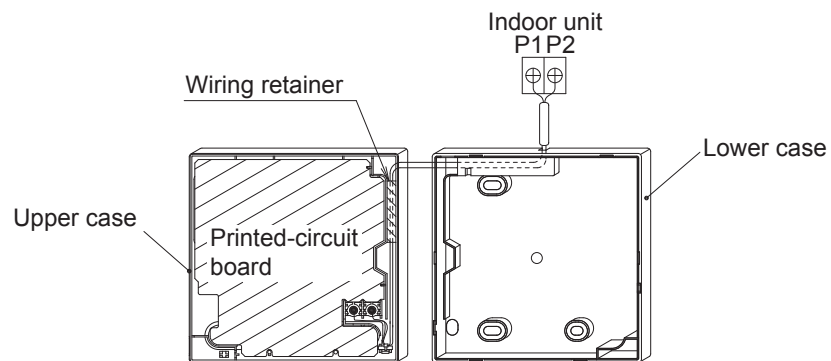

NOTE

- To prevent electrical noise and possible communication errors, avoid installing the remote controller wiring parallel to or in the vicinity of line voltage circuits.

3-6 Installation procedure for the lower case.

When wiring the remote controller through the top center or rear access points, attachment of the wire to the lower case is required before it is wall mounted. Closely follow the wiring procedures.

3-6-1 Wall installation

Secure by using furnished drywall anchors and screws (2 pcs.).

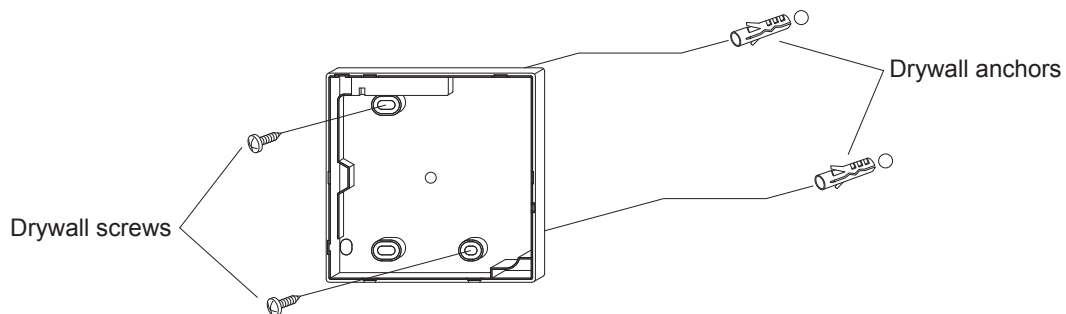

3-6-2 Switch box installation

Secure by using field supplied machine screws (2 pcs.).

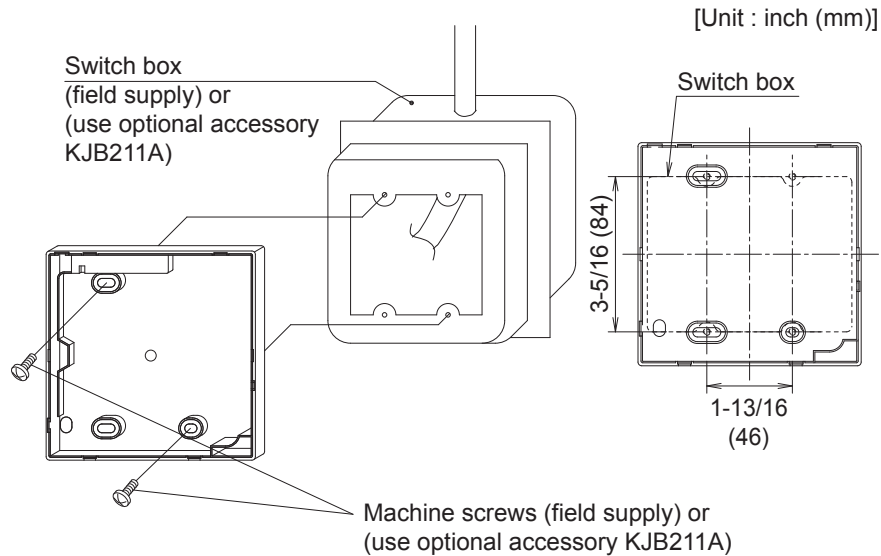

NOTE

- Install the control on a flat surface only.
- To prevent deformation of the lower case, avoid over-tightening the installation screws.

3-7 Install the upper case.

- Align the upper case with tabs of the lower case (6 points), insert and install the upper case.
- Install the wiring with care to prevent pinching.
- Peel off the protective membrane which overlays the upper case.

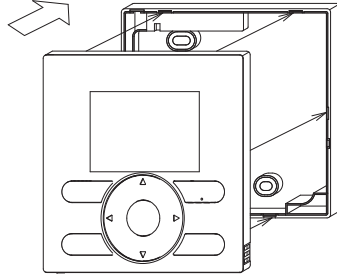

4. Functions and Menu Items of Remote Controller Buttons

4-1 Functions and menu items

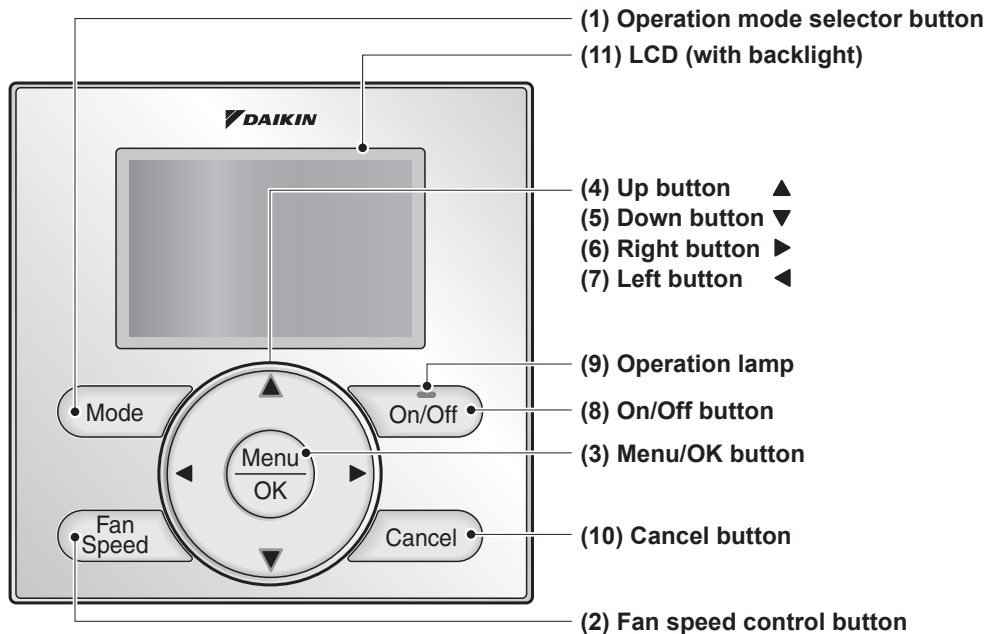

(1) Operation mode selector button

Used to change the mode.

(2) Fan speed control button

Used to change the fan control.

(3) Menu/OK button

- Used to access the main menu.
(For details of the main menu, see the operation manual.)
- Used to enter the item selected.

Main Menu

*Airflow Direction
 *Individual Airflow Direction
 *Ventilation
 Schedule
 Off Timer
 Celsius / Fahrenheit
 Filter Auto Clean
 Maintenance Information
 Configuration
 Current Settings
 Clock & Calendar
 Daylight Saving Time
 Language

*Depending on connected model

(4) Up button ▲

- Used to raise the setpoint temperature.
- The previous menu items will be highlighted.
(The highlighted items will be scrolled continuously when the button is pressed continuously.)
- Used to change the selected item.

(5) Down button ▼

- Used to lower the setpoint temperature.
- Items below the currently selected item will be highlighted.
(The highlighted items will be scrolled continuously when the button is pressed continuously.)
- Used to change the selected item.

(6) Right button ►

- Used to highlight items to the right of the currently selected item.
- Display contents are changed to next screen per page.

(7) Left button ◀

- Used to highlight items to the left of the currently selected item.
- Display contents are changed to previous screen per page.

(8) On/Off button

Press once to operate, and press once again to stop.

(9) Operation lamp

Green lamp lights up during operation. The lamp will flash if a malfunction occurs.

(10) Cancel button

- Used to return to the previous screen.
- Press and hold this button for 4 seconds or longer to display service settings menu.

(11) LCD (with backlight)

The backlight will illuminate for approximately 30 seconds by pressing any operation button.

Service Settings menu

- Test Operation
- Maintenance Contact
- Field Settings
- *Energy Saving Options
- Prohibit Function
- Min Setpoints Differential
- *Outdoor unit AirNet Address
- Error History
- *Indoor Unit Status
- *Outdoor Unit Status
- Forced Fan ON
- Switch Main Sub Controller
- Filter Indicator
- *Brush/Filter Ind.
- *Disable Filter Auto Clean

*Depending on connected model

⚠ NOTE

- Operate the button while the backlight is illuminated.
- When one indoor unit is controlled by two remote controllers (main / sub) only the first controller to be accessed by the user will illuminate it's backlight.

4-2 Button menu display descriptions

<Service settings menu screen>

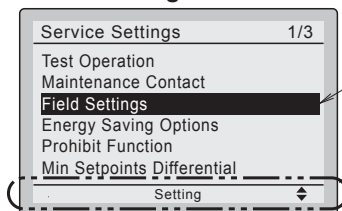

Highlighted display (selected items)

In the highlighted display (selected items) setting screen, button operation descriptions are displayed.

5. Power-on

- Check for completion of indoor/outdoor unit wiring.
- Ensure that covers have been replaced on electrical component boxes for both indoor and outdoor units prior to restoring power.

5-1 The following message is displayed after power-on.
Checking the connection.
Please stand by.

When the above message is displayed, the backlight will not be ON.

In the case that 1 indoor unit is controlled by 2 remote controllers:

Make sure to set the sub remote controller when the above message is displayed. Hold **Mode** button for 4 seconds or longer to set.

When the display is changed from "Main RC" to "Sub RC" the setting is completed.

5-2 Basic screen is displayed.

NOTE

If sub remote controller is not set at power-on in the case of one indoor unit controlled by two remote controllers, **Error Code: U5** is displayed in the connection checking screen.

Select the sub remote controller by pressing **Mode** button of either one of the remote controllers for 4 seconds or longer.

If the basic screen is not displayed in 2 minutes after the "Sub RC" is displayed, shut off the power supply and check the wiring.

NOTE

When selecting a different language, refer to **Chapter 12. Language.**
 (See page 22.)

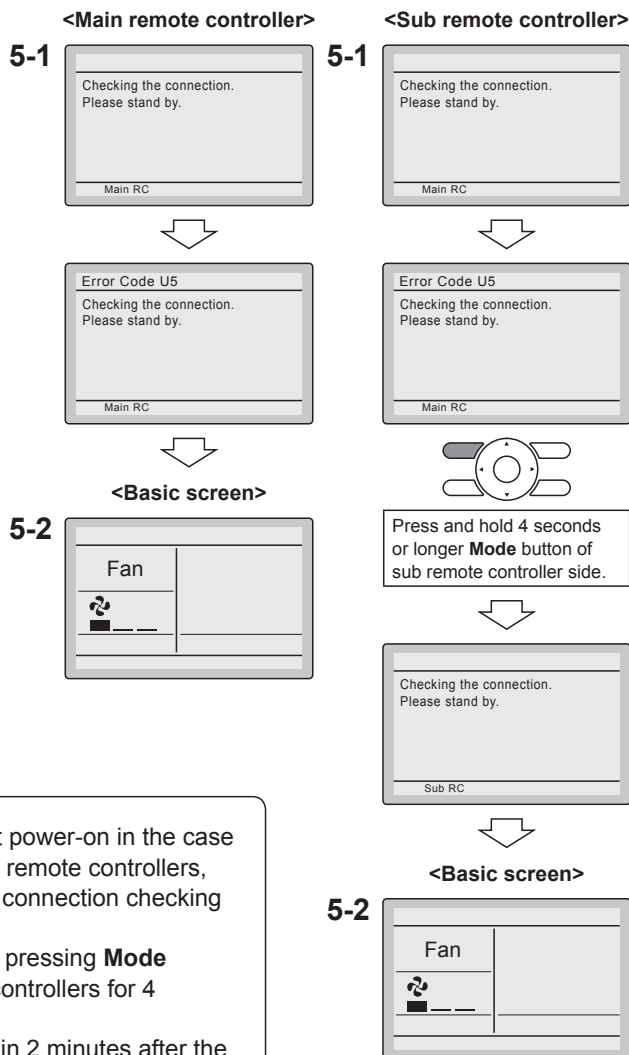

6. Field Settings

6-1 Press and hold **Cancel** button for 4 seconds or longer.
Service settings menu is displayed.

6-2 Select **Field Settings** in the Service Settings menu, and press **Menu/OK** button.
Field settings screen is displayed.

6-3 Highlight the mode, and select desired "Mode No." by using **▲▼** (Up/Down) button.

6-4 In the case of setting per indoor unit during group control (When Mode No. such as **20**, **21**, **22**, **23**, **25** are selected), highlight the unit No. and select "Indoor unit No." to be set by using **▲▼** (Up/Down) button. (In the case of group setting, this operation is not needed.)

In the case of individual setting per indoor unit, current settings are displayed. And, SECOND CODE NO. " - " means no function.

6-5 Highlight SECOND CODE NO. of the FIRST CODE NO. to be changed, and select desired "SECOND CODE NO." by using **▲▼** (Up/Down) button. Multiple identical mode number settings are available.

In the case of setting for all indoor units in the remote control group, available SECOND CODE NO. is displayed as " * " which means it can be changed. When SECOND CODE NO. is displayed as " - ", there is no function.

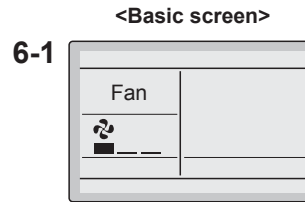

6-1



Press and hold **Cancel** button for 4 seconds or longer during backlight lit.



<Service settings menu screen>

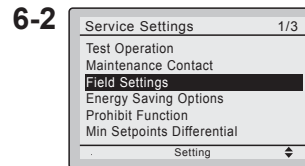

Press **Menu/OK** button.



<Service settings screen>

In the case of individual setting per indoor unit

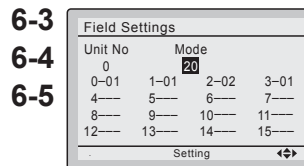

In the case of group total setting

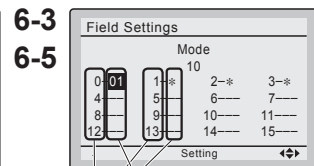

SECOND CODE NO.
FIRST CODE (SW) NO.



Press **Menu/OK** button.

6-6 Press **Menu/OK** button. Setting confirmation screen is displayed.

6-7 Select **Yes** and press **Menu/OK** button. Setting details are determined and field settings screen returns.

6-8 In the case of multiple setting changes, repeat “**6-3**” to “**6-7**”.

6-9 After all setting changes are completed, press **Cancel** button twice.

6-10 Backlight goes out, and **[Checking the connection. Please stand by.]** is displayed for initialization. After the initialization, the basic screen returns.

↓
<Setting confirmation screen>

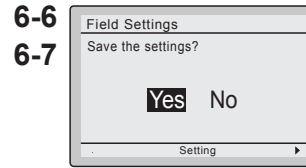

Press **Menu/OK** button.



Setting confirmation

NOTE

- Installation of optional accessories on the indoor unit may require changes to field settings. See the manual of the optional accessory.
- For field setting details related to the indoor unit, see installation manual shipped with the indoor unit.

Mode No. (Note 1)	First Code No.	Description	Second Code No. (Note 2) (Items in bold are factory default settings)													
			01	02	03	04	05	06	07	08	09	10	11	12	13	
10 (20)	2	Priority of thermistor sensors for space temperature control	The return air thermistor is primary and the remote controller thermistor is secondary.	The remote controller thermistor is not utilized. Only the return air thermistor will be utilized.	Only the remote controller thermistor will be utilized.	—	—	—	—	—	—	—	—	—	—	
	5	Room temperature value reported to multizone controllers	Return air thermistor	Thermistor designated by 10-2 above (Note 3)	—	—	—	—	—	—	—	—	—	—	—	—
12 (22)	2	Thermo-on/off deadband (Note 4)	2F (1C)	1F (0.5C)	—	—	—	—	—	—	—	—	—	—	—	—
	1	Thermistor sensor for auto changeover and setback control by the remote controller	Utilize the return air thermistor	Utilize the remote controller thermistor	—	—	—	—	—	—	—	—	—	—	—	—
	3	Access permission level setting	Level 2	Level 3	—	—	—	—	—	—	—	—	—	—	—	—
	10	Remote controller thermostat offset (Main RC, Auto mode) (Note 5)	-5.4F (-3.0C)	-4.5F (-2.5C)	-3.6F (-2.0C)	-2.7F (-1.5C)	-1.8F (-1.0C)	-0.9F (-0.5C)	±0.0F (±0.0C)	0.9F (0.5C)	1.8F (1.0C)	2.7F (1.5C)	3.6F (2.0C)	4.5F (2.5C)	5.4F (3.0C)	5.4F (3.0C)
	11	Remote controller thermostat offset (Sub RC, Auto mode) (Note 5)	-5.4F (-3.0C)	-4.5F (-2.5C)	-3.6F (-2.0C)	-2.7F (-1.5C)	-1.8F (-1.0C)	-0.9F (-0.5C)	±0.0F (±0.0C)	0.9F (0.5C)	1.8F (1.0C)	2.7F (1.5C)	3.6F (2.0C)	4.5F (2.5C)	5.4F (3.0C)	5.4F (3.0C)
1c	12	Remote controller thermostat offset (Main RC, Cool mode) (Note 5)	-5.4F (-3.0C)	-4.5F (-2.5C)	-3.6F (-2.0C)	-2.7F (-1.5C)	-1.8F (-1.0C)	-0.9F (-0.5C)	±0.0F (±0.0C)	0.9F (0.5C)	1.8F (1.0C)	2.7F (1.5C)	3.6F (2.0C)	4.5F (2.5C)	5.4F (3.0C)	5.4F (3.0C)
	13	Remote controller thermostat offset (Main RC, Heat mode) (Note 5)	-5.4F (-3.0C)	-4.5F (-2.5C)	-3.6F (-2.0C)	-2.7F (-1.5C)	-1.8F (-1.0C)	-0.9F (-0.5C)	±0.0F (±0.0C)	0.9F (0.5C)	1.8F (1.0C)	2.7F (1.5C)	3.6F (2.0C)	4.5F (2.5C)	5.4F (3.0C)	5.4F (3.0C)
	14	Remote controller thermostat offset (Sub RC, Cool mode) (Note 5)	-5.4F (-3.0C)	-4.5F (-2.5C)	-3.6F (-2.0C)	-2.7F (-1.5C)	-1.8F (-1.0C)	-0.9F (-0.5C)	±0.0F (±0.0C)	0.9F (0.5C)	1.8F (1.0C)	2.7F (1.5C)	3.6F (2.0C)	4.5F (2.5C)	5.4F (3.0C)	5.4F (3.0C)
	15	Remote controller thermostat offset (Sub RC, Heat mode) (Note 5)	-5.4F (-3.0C)	-4.5F (-2.5C)	-3.6F (-2.0C)	-2.7F (-1.5C)	-1.8F (-1.0C)	-0.9F (-0.5C)	±0.0F (±0.0C)	0.9F (0.5C)	1.8F (1.0C)	2.7F (1.5C)	3.6F (2.0C)	4.5F (2.5C)	5.4F (3.0C)	5.4F (3.0C)
1e	2	Setback availability	N/A	Heat only	Cool only	Cool/Heat	—	—	—	—	—	—	—	—	—	—

- Notes)
1. Field settings are normally applied to the entire remote control group, however if individual indoor units in the remote control group require specific settings or for confirmation that settings have been established, utilize the mode number in parenthesis.
 2. Any features not supported by the connected indoor unit will not be displayed.
 3. When mode 10-2-01 is selected, only the return air temperature value is reported to the multizone controller.
 4. The actual default deadband value will depend upon the indoor unit model.
 5. If different offset values are set for cooling and heating modes, the following issues may occur in auto operation mode:
 - The indoor unit may switch more frequently between cooling/heating modes
 - The indoor unit may switch less frequently between cooling/heating modes
 - Setback on/off may happen more frequently
 - Setback on/off may happen less frequently
 To avoid these issues, set the offset values for auto mode.

7. Test Operation

Also see installation manuals furnished with the indoor unit and the outdoor unit.

- Verify that the wiring of the indoor unit and the outdoor unit is completed.
- Ensure that covers have been replaced on electrical component boxes for both indoor and outdoor units prior to restoring power.
- After refrigerant piping, drain piping and electric wiring are completed, clean inside of the indoor unit and decorative panel.
- Perform the test operation according to following procedure.
- To protect the compressor, apply power to the outdoor unit at least 6 hours prior to test operation.
- Set the remote controller display mode to standard or detailed display mode. Refer to Operation Manual for the setting method.

Notes for backlight

- The backlight will be ON for 30 seconds by pressing any button.
- The initial push of the button will only turn on the backlight. While the backlight is turned on, the buttons assigned functionality will be available.

7-1 Set the operation mode to cooling by using the remote controller.

7-2 Press and hold **Cancel** button for 4 seconds or longer. Service settings menu is displayed.

7-3 Select **Test Operation** in the service settings menu, and press **Menu/OK** button. Basic screen returns and message "Test Operation" is displayed at the bottom.

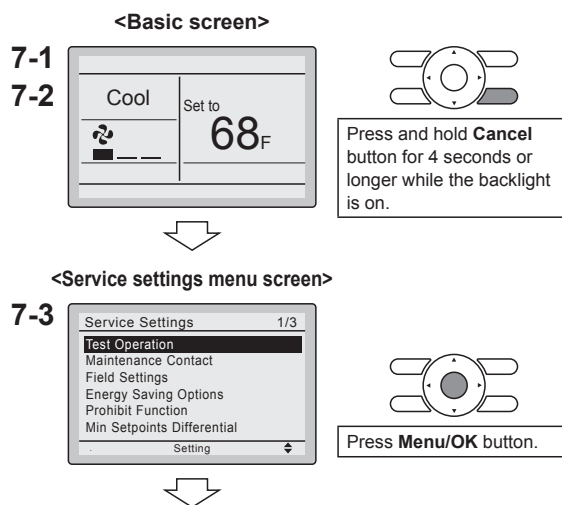

7-4 Press **On/Off** button within 10 seconds, and the test operation starts. Monitor the operation of the indoor unit for a minimum of 10 minutes. During test operation, the indoor unit will continue to cool regardless of the temperature setpoint and room temperature.

* Note) In the case of above-mentioned procedures **7-3** and **7-4** in reverse order, test operation can start as well.

7-5 Press **Menu/OK** button in the basic screen. Main menu is displayed.

7-6 In the case of a model having airflow direction function, select **Airflow Direction** in the main menu and check that airflow direction is actuated according to the setting. For operation of airflow direction setting, see the operation manual.

7-7 After the operation of airflow direction is confirmed, press **Menu/OK** button. Basic screen returns.

7-8 Press and hold **Cancel** button for 4 seconds or longer in the basic screen. Service settings menu is displayed.

7-9 Select **Test Operation** in the service settings menu, and press **Menu/OK** button. Basic screen returns and normal operation is conducted.
* Note) The test operation will automatically finish in 30 minutes.

7-10 Check the functions according to the operation manual.

7-11 When the decorative panel is not installed, shut off the power supply after the test operation finishes.

- If construction activities are planned within the space following the test operation procedure, recommend to the customer that the indoor unit is not operated to prevent contamination from paints, drywall dust and other airborne materials.

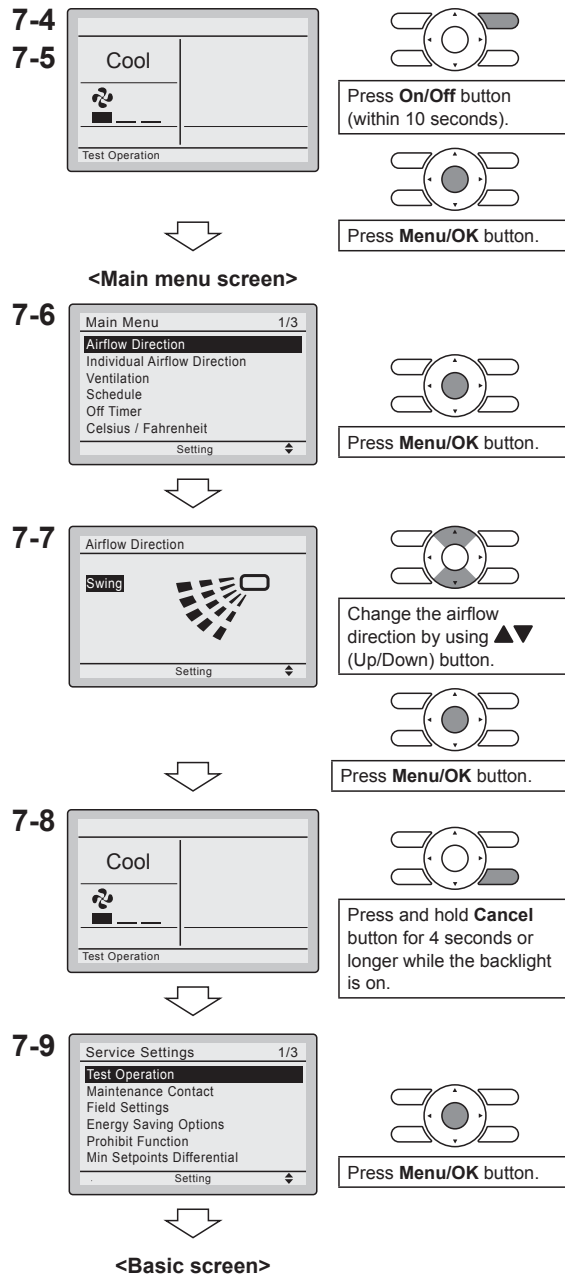

⚠ NOTE

- If operation is not possible due to a malfunction, refer to following **Failure diagnosis method**.
- After the test operation finishes, check whether the error code history is displayed on the maintenance information screen of the main menu according to the following procedure.

7-12 Press **Menu/OK** button in the basic screen. Main menu screen is displayed.

7-13 Select **Maintenance Information** in the main menu, and press **Menu/OK** button.

7-14 Maintenance information screen is displayed. Check whether the error code history is displayed on the screen.

* If no error code history is displayed following this procedure the system has normally completed the test operation mode.

7-15 If the error code history is displayed, conduct the failure diagnosis referring to <Error code list> in the installation manual of the indoor unit. After the failure diagnosis finishes, press and hold **On/Off** button for 4 seconds or longer in the maintenance information screen to erase the error code history.

<Basic screen>

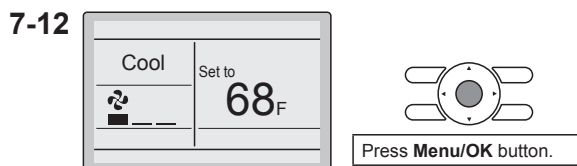

<Main menu screen>

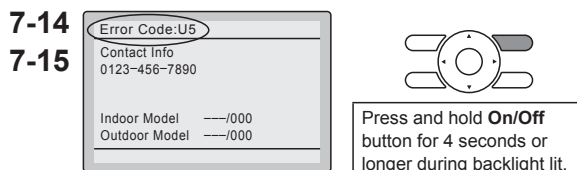
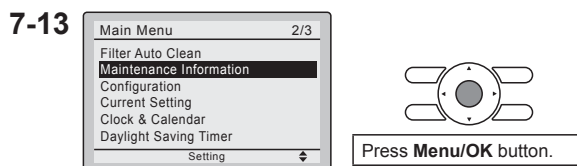

Failure diagnosis method

- Whenever the remote controller display is blank or displays [**Checking the connection. Please stand by.**], troubleshoot the system with the items in the Description column of the following table.
- If an error occurs, **CODE** is displayed on the LCD as shown to the right. Conduct the failure analysis referring to <Error code list> in the installation manual of the indoor unit. When the unit No. which detected the error during group control is confirmed, refer to **Chapter 8: Procedure for Checking Error History**.

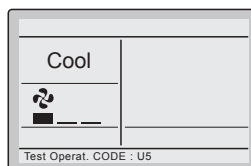

Remote controller display	Description
No display	<ul style="list-style-type: none"> • Power outage, power voltage error or open-phase • Incorrect wiring (between indoor and outdoor units) • Indoor printed-circuit board assembly failure • Remote controller wiring not connected • Remote controller failure • Open fuse or tripped circuit breaker (outdoor unit)
Checking the connection. Please stand by. *	<ul style="list-style-type: none"> • Indoor printed-circuit board assembly failure • Wrong wiring (between indoor and outdoor units)

* [Checking the connection. Please stand by.] will be displayed for up to 90 seconds following the application of power to the indoor unit. This is normal and does not indicate a malfunction.

8. Procedure for Checking Error History

8-1 Press and hold **Cancel** button for 4 seconds or longer in the basic screen. Service settings menu is displayed.

8-2 Select **Error History** in the service settings menu, and press **Menu/OK** button. The error history menu screen is displayed.

8-3 Select **RC Error History** in the error history menu, and press **Menu/OK** button.
Error codes and unit No. can be confirmed in the RC error history screen.

8-4 In the error history, the 10 most recent items are displayed in order of occurrence.

8-5 Press **Cancel** button in the RC error history screen 3 times.
The basic screen returns.

8-1 <Basic screen>



<Service settings menu screen>

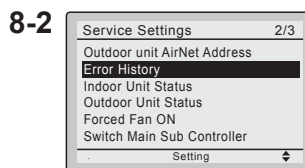

Press **Menu/OK** button.

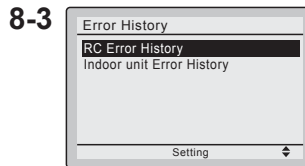

Press **Menu/OK** button.

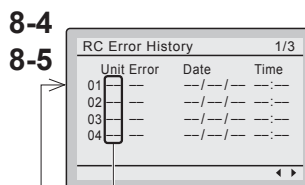

Unit No.

Latest record

9. Adding Maintenance Contact Information

- Registration of the maintenance contact.

- 9-1** Press and hold **Cancel** button for 4 seconds or longer in the basic screen.
Service settings menu is displayed.
- 9-2** Select **Maintenance Contact** in the service settings menu, and press **Menu/OK** button. Maintenance contact menu screen is displayed.
- 9-3** Select **Maintenance Contact**, and press **Menu/OK** button.
- 9-4** Enter the telephone number.
Scroll through the numbers by using **▲▼** (Up/Down) buttons. Start from the left side. Blank digits should remain as “-”.
- 9-5** Press **Menu/OK** button.
Setting confirmation screen is displayed.
- 9-6** Select **Yes** and press **Menu/OK** button.
Setting details are saved and service settings menu screen returns.
- 9-7** Press **Cancel** button once.
The basic screen returns.

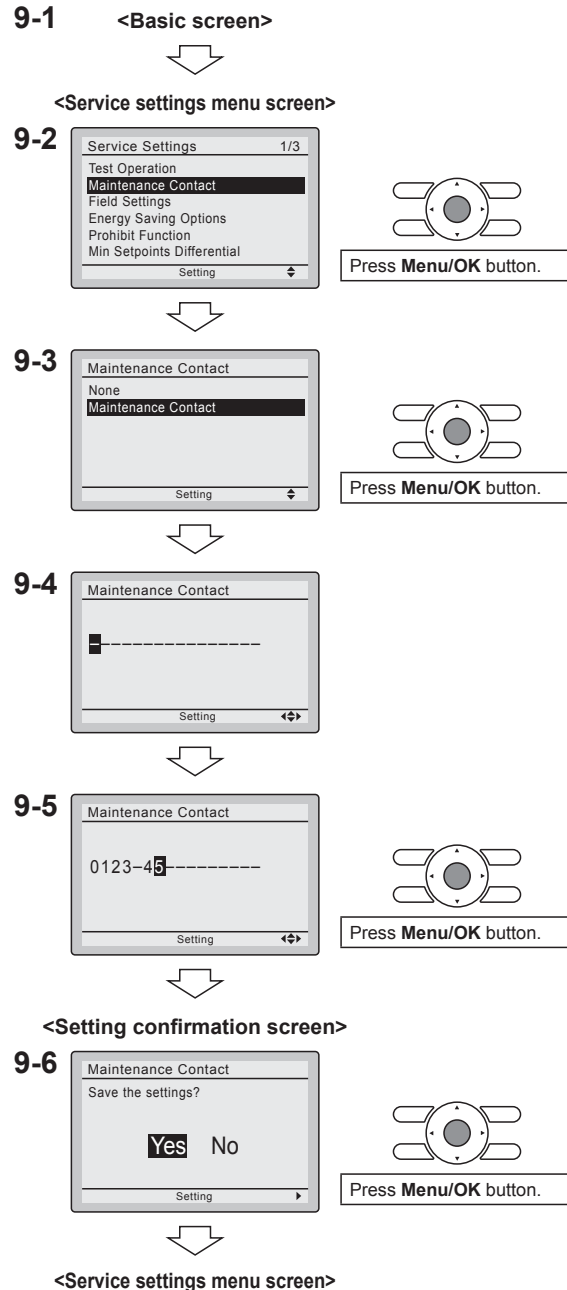

10. Confirming Registered Details

- 10-1** Press **Menu/OK** button in the basic screen.
Main menu is displayed.
Select **Maintenance Information** in the main menu, and press **Menu/OK** button.

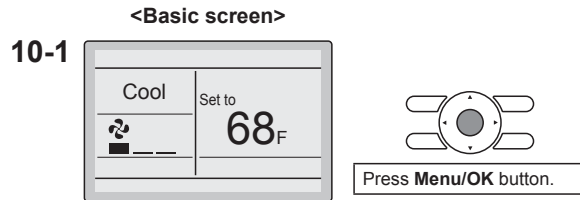

- 10-2** Press **Cancel** button twice.
The basic screen returns.

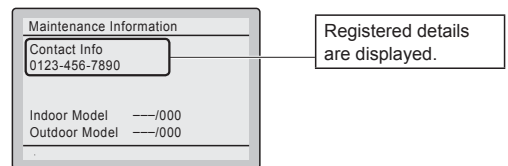
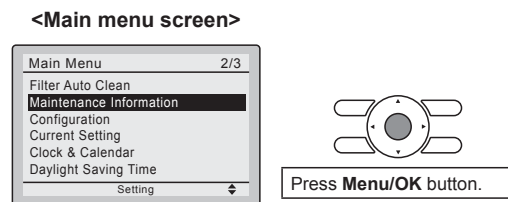

11. Clock & Calendar

- 11-1** Press **Menu/OK** button in the basic screen.
Main menu is displayed.
Select **Clock & Calendar** in the main menu, press **Menu/OK** button.

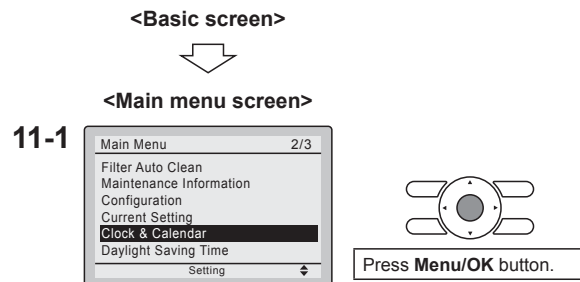

- 11-2** Press **▲▼** buttons to select **Date & Time** on the clock & calendar screen.
* The date & time screen will appear when **Menu/OK** button is pressed.

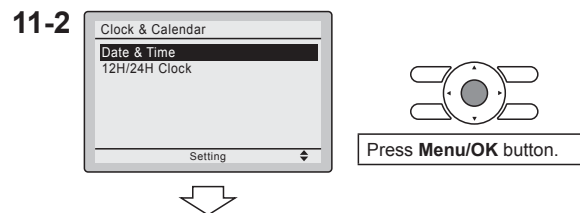

- 11-3** Select **year, month, day** and **time** by using ◀▶ (Left/Right) button and set by using ▲▼ (Up/Down) button in the date & time screen. Press and hold the button for continuous change of the numeric value.
* Day of the week is set automatically.

- 11-4** Press **Menu/OK** button.
Setting confirmation screen is displayed.

- 11-5** Select **Yes** and press **Menu/OK** button.
Setting details are saved and basic screen returns.

* If power outage exceeds 48 hours, reset is needed.

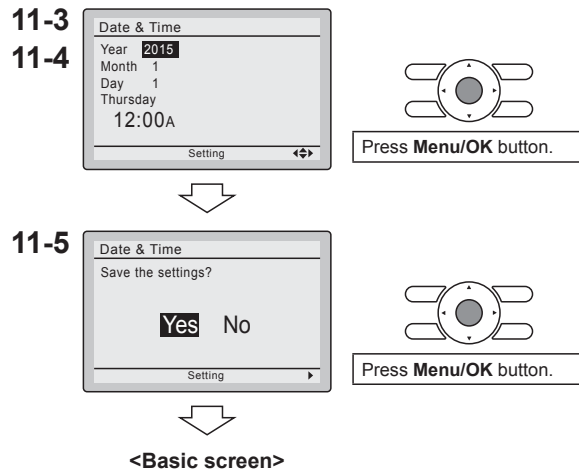

12. Language

- 12-1** Press **Menu/OK** button in the basic screen.
Main menu is displayed.
Select **Language** in the main menu, press **Menu/OK** button.

- 12-2** Press ▲▼ (Up/Down) buttons to select **Language** on the language screen.
English/Français/Español
Press **Menu/OK** button.

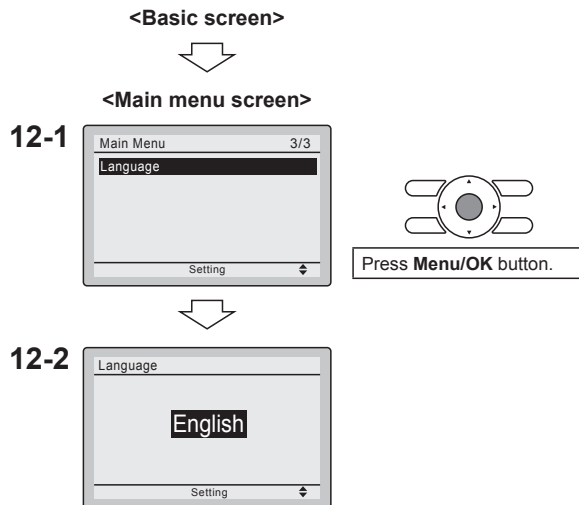

3.2 BRC082A43 for CDMQ, FDMQ

CONTENTS



- 1. SAFETY CONSIDERATIONS 2
- 2. BEFORE INSTALLATION 2
- 3. REMOTE CONTROLLER INSTALLATION 2
- 4. RECEIVER INSTALLATION 3
- 5. FIELD SETTING 6
- 6. TEST OPERATION 6

1. SAFETY CONSIDERATIONS

Please read these "SAFETY CONSIDERATIONS" carefully before installing air conditioning equipment and be sure to install it correctly. After completing the installation, make sure that the unit operates properly during the start-up operation. Please instruct the customer on how to operate the unit and keep it maintained.

Also, inform customers that they should store this installation manual along with the operation manual for future reference. This air conditioner comes under the term "appliances not accessible to the general public".

Meaning of warning, caution and note symbols.

-  **WARNING** Indication a potentially hazardous situation which, if not avoided, could result in death or serious injury.
-  **CAUTION** Indication a potentially hazardous situation which, if not avoided, may result in minor or moderate injury. It may also be used to alert against unsafe practices.
-  **NOTE** Indication situation that may result in equipment or property-damage-only accidents.

- WARNING**
- **Perform installation work in accordance with this installation manual.**
Improper installation may result in electric shocks or fire.
 - **Be sure to use only the specified accessories and parts for installation work.**
Failure to use the specified parts may result in, electric shocks, fire or the unit falling.
 - **Before touching electrical parts, turn off the unit.**
 - **Do not touch the switch with wet fingers.**
Touching a switch with wet fingers can cause electric shock.



- CAUTION**
- **Refer also to the installation manuals attached to the indoor unit and the decoration panel.**
 - **Confirm that the following conditions are satisfied prior to installation.**
Ensure that nothing interrupts the operation of the wireless remote controller. (Ensure that there is neither a source of light nor fluorescent lamp near the receiver. Also, ensure that the receiver is not exposed of direct sunlight.)
Ensure that the operation display lamp and other indicators are easy to see.



- **The installation position of this receiver is one corner of the decoration panel. Therefore, confirm that its position is set so that the signal from the wireless remote controller can be easily transmitted and its display can be easily seen.**
- **If both this kit and fresh air intake kit are installed, only one duct chamber shall be used. Refer to the installation manual of the fresh air intake kit (optional hand book).**

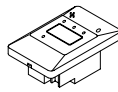

2. BEFORE INSTALLATION

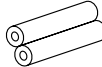

2-1 ACCESSORIES

Check if the following accessories are included with the unit.

Name	(1) Receiver	(2) Wireless remote controller	(3) Remote controller holder
Quantity	1 pc.	1 pc.	1 pc.
Shape			

Name	(4) Dry cell battery LR03 (AM4)	(5) Unit No. label	(6) Screw for installing remote controller holder
Quantity	2 pcs.	1 pc.	2 pcs.
Shape			 M3.5

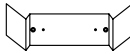
Name	(7) Mounting screw (Black)	(8) Mounting screw	(9) Paper pattern printing
Quantity	2 pcs.	2 pcs.	1 pc.
Shape	 M4	 M5	 3-15/16x1-15/16 (in.)

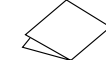
Name	(10) Winged bar	(11) Operation manual	(12) Installation manual
Quantity	1 pc.	1 pc.	1 pc.
Shape			

2-2 NOTE TO THE INSTALLER

Be sure to instruct the customer how to properly operate the system showing him/her the attached operation manual.

3. REMOTE CONTROLLER INSTALLATION

<Installing wireless remote controller>

- Do not throw the remote controller or impose large shocks. Also, do not store where it may be exposed to moisture or direct sunlight.

- When operating, point the transmitting part of the remote controller in the direction of the receiver.
- The direct transmitting distance of the remote controller is approximately 23 ft..
- The signal cannot be transmitted if something such as curtains blocks the receiver and the remote controller.

Installing to a wall or a pillar

1. Fix the remote controller holder (3) with the screws (6).

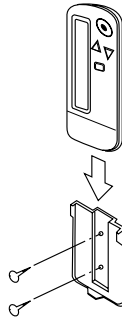

2. Slide the remote controller (2) into the remote controller holder (3) from the top.

How to put the dry cell batteries

1. Remove the back cover of the remote controller (2) to the direction pointed by the arrow mark.
2. Put the dry cell batteries. Use two LR03<AM4> dry cell batteries (4). Put the dry cell batteries (4) correctly to fit their (+) and (-).
3. Close the back cover as before.

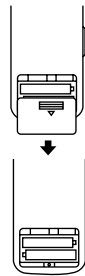

4. RECEIVER INSTALLATION

CAUTION

- Do not install more than 3 receivers in the vicinity of one another.
- With 4 or more units, there is always the possibility of malfunction.

4-1. Preparations before installation

Remove the upper part of the receiver (1).

- Insert the screwdriver (-) here and gently work off the upper part of the receiver (1).

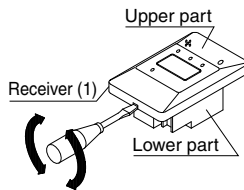

4-2. Determination of address and MAIN/SUB remote controller

If setting multiple wireless remote controllers to operate in 1 room, perform address setting for the receiver and the wireless remote controller. If setting multiple wired remote controllers in 1 room, change the MAIN/SUB switch of the receiver.

4-3. Setting procedure

- Setting the receiver
Set the wireless address switch (SS2) on the PC-board according to the table below.

Unit No.	No.1	No.2	No.3
Wireless address switch (SS2)	1 2 3	1 2 3	1 2 3

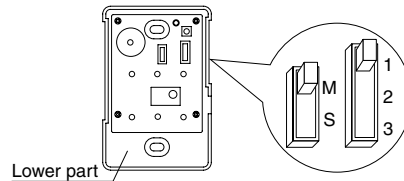
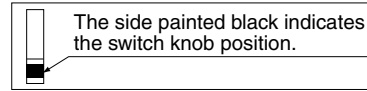

CAUTION

Change the setting so that the internal electronic equipments are not damaged with a pen etc.

When using both a wired and a wireless remote controller for 1 indoor unit, the wired controller should be set to MAIN. Therefore, set the MAIN/SUB switch (SS1) of the receiver to SUB.

	MAIN	SUB
MAIN/SUB switch (SS1)	M S	M S

4-4. Receiver installation

WARNING

Be sure to turn off the power before installation.

CAUTION

<Precautions on transmission wiring>

1. When wiring, run the wiring away the power supply wiring in order to avoid receiving electric noise (external noise).
2. When wiring, refer to the wiring diagram of indoor unit (attached to indoor unit) as well.

WIRING SPECIFICATION

Wiring type	Sheathed wire (2 wire)
Size	AWG18-16
Wiring length	Max 650 ft. (See Note)

NOTE

Keep wires to less than 650 ft. total when using 2 remote controllers (wired or wireless) and when not.

4-5. Attaching the receiver (for ceiling installation)

1. Prepare the ceiling for the receiver.
 - Open a hole in the ceiling for the receiver. (Use paper pattern printing (9)).

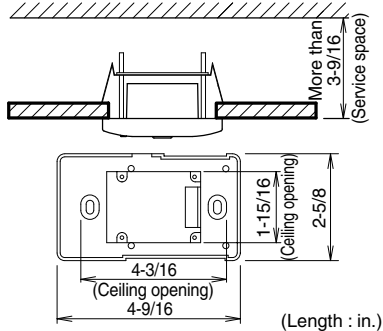

2. Wire the indoor unit and fix the lower part.
 - Install the winged bar (10) to the lower part and fit the part with the screws (8). Then, wire (field supplied) accordingly. (Connect the P1 and P2 terminals on the rear of the lower part to the P1 and P2 terminals on the indoor unit. The P1 and P2 terminals have no polarity.)

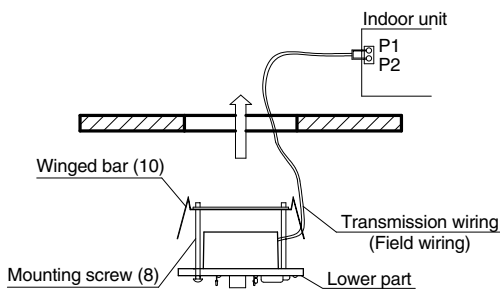

- Insert the lower part into the opening in the ceiling, first by pressing the wings inward to fit the hole and then by pushing from the screws (8) until it sits flat on the ceiling.

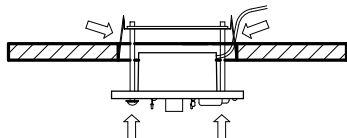

- Tighten the screws (8) until the lower part is fixed in place.

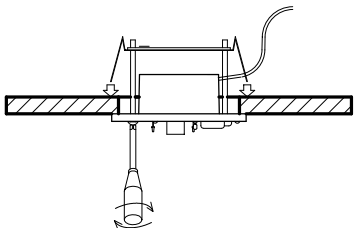

(Tighten both screws (8) evenly. Overtightening may deform the case and possibly make it harder to install the upper part.)

- Attach the upper part of receiver (1).

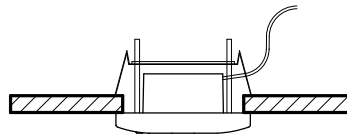

(Install the upper part on the lower part being careful parts are facing in the correct direction. After installation, turn on the power, and test emergency run button.)

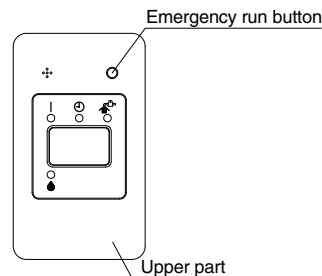

4-6 Attaching the receiver (for wall mounting)

1. Wire the indoor unit.

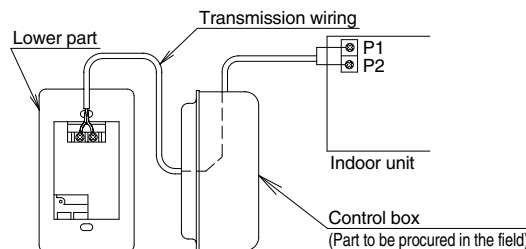

(Connect the P1 and P2 terminals on the rear of the lower part to the P1 and P2 terminals on the indoor unit. Neither of the terminals is polarized, so it is not important if connections are crossed.)

2. Fix the lower part.

- Install the lower part on the control box (field supplied part). (Select as flat a place as possible to install the lower part. Also, be aware of the fact that overtightening the screws (7) may deform the case and possibly make it harder to install the upper part.)

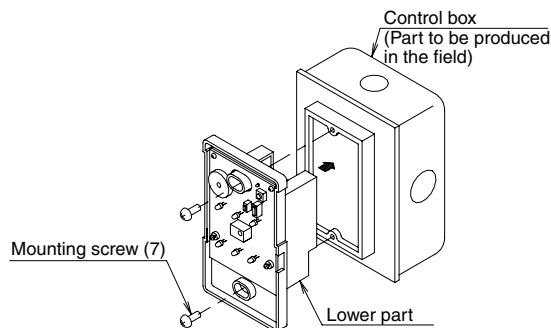

- Attach the upper part of remote controller.
(Install the upper part on the lower part being careful parts are facing in the correct direction. After installation, turn on the power, and test emergency run button.)

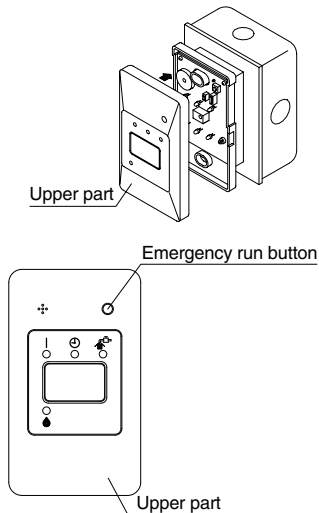

NOTE

- The control box and wiring are not included.
- Do not directly touch the PC-board with your hand.

4-7. Setting the address of wireless remote controller (It is factory set to "1".)

<Setting from the remote controller>

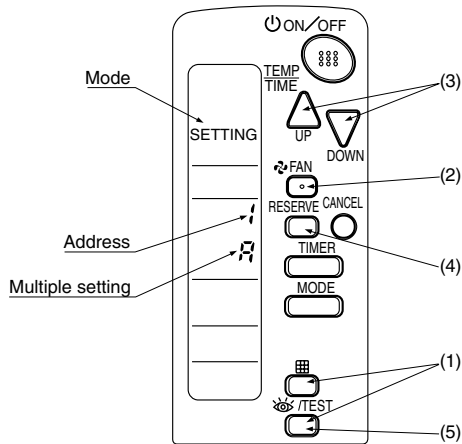

- Hold down the " [Grid] " button and the " [TEST] " button for at least 4 seconds to get the FIELD SET MODE. (Indicated in the display area in the figure at top.)
- Press the " [FAN] " button and select a multiple setting (A/b). Each time the button is pressed the display switches between "A" and "b".

- Press the " [UP] " button and " [DOWN] " button to set the address.

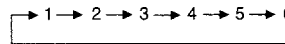

Address can be set from 1 to 6, but set it from 1 to 3 and to same address as the receiver. (The receiver does not work with address from 4 to 6.)

- Press the " [RESERVE] " button to enter the setting.
- Push the " [TEST] " button to quit the FIELD SET MODE and return to the normal display.

<Multiple settings A/b>

When the indoor unit is being operating by outside control (central remote controller, etc.), it sometimes does not respond to ON/OFF and temperature setting commands from this remote controller. Check what setting the customer wants and make the multiple setting as shown below.

Remote controller		Indoor unit	
Multiple setting	Remote controller display	To control other air conditions and units	For other than on left
A: Standard	All items displayed.	Commands other than ON/OFF and temperature setting accepted. (1 LONG BEEP or 3 SHORT BEEPS emitted)	
b: Multi System	Operations remain displayed shortly after execution	All commands accepted. (2 SHORT BEEPS)	

4-8. Stick the Unit No. label on the receiver and the back of the wireless remote controller.

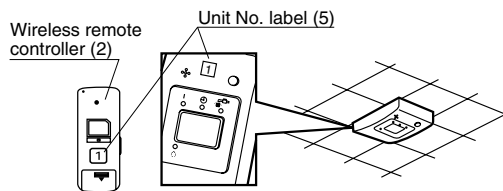

CAUTION

Set the Unit No. of the receiver and the wireless remote controller to be equal. If the settings differ, the signal from the remote controller cannot be transmitted.

5. FIELD SETTING

If optional accessories are mounted on the indoor unit, the indoor unit setting may have to be changed. Refer to the instruction manual (optional hand book) for each optional accessory.

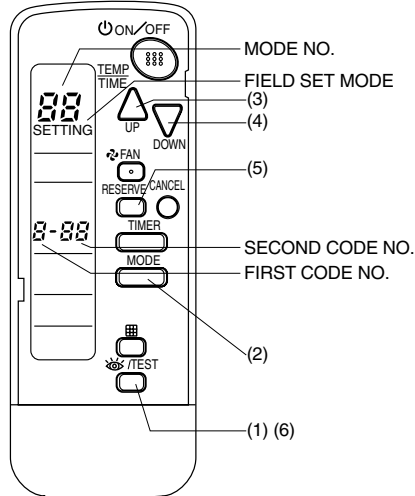

Procedure

- (1) When in the normal mode, press the “/TEST” button for at least 4 seconds, and the FIELD SET MODE is entered.
- (2) Select the desired MODE NO. with the “/MODE” button.
- (3) Push the “/UP” button and select the FIRST CODE NO..
- (4) Push the “/DOWN” button and select the SECOND CODE NO..
- (5) Push the “/RESERVE” button and the present settings are set.
- (6) Push the “/TEST” button to quit the FIELD SET MODE and return to the normal display.

(Example) If the time to clean air filter is set to “Filter Contamination-Heavy”, set Mode No. to “10”, FIRST CODE NO. to “0”, and SECOND CODE NO. to “02”.

MODE NO.	FIRST CODE NO.	DESCRIPTION OF SETTING	
10	0	Filter Contamination-Heavy/Light (Setting for spacing time of display time to clean air filter) (Setting for when filter contamination is heavy, and spacing time of display time to clean air filter is to be halved)	Long-life type
			Standard type
	3	Spacing time of display time to clean air filter count (Setting for when the filter sign is not to be displayed)	
12 (VRV system)	1	ON/OFF input from outside (Set to enable starting/stopping from remote.)	
	2	Thermostat differential changeover (Set when using remote controller thermostat sensor.)	

MODE NO.	FIRST CODE NO.	SECOND CODE NO.		
		01	02	03
10	0	Light Approx. 2,500 hours	Heavy Approx. 1,250 hours Approx. 100 hours	—
		Approx. 200 hours		
	3	Display	Do not display	—
12 (VRV system)	1	Forced OFF input	ON/OFF	—
	2	2°F	1°F	—

NOTE
 The SECOND CODE NO. is factory set to "01".
 Do not use any settings not listed in the table.
 For group control with a wireless remote controller, initial settings for all the indoor units of the group are equal. (For group control, refer to the installation manual attached to the indoor unit for group control.)

6. TEST OPERATION

- Perform test operation according to the instructions in the installation manual attached to the indoor unit.
- After refrigerant piping, drain piping, and electric wiring, operate according to the table to protect the unit.

CAUTION

1. Refer to a malfunction code in the installation manual attached to the outdoor unit if it does not operate.
2. Refer to the installation manual attached to the outdoor unit for individual operation system types.
 Some of our product types should have the power supply turned ON 6 hours before starting operation in order to electrify crank case heater.
 Refer to the installation manual attached to the outdoor unit.

Order	Operation
(1)	Open gas side stop valve.
(2)	Open liquid side stop valve.
(3)	Set to cooling with the remote controller and push “/ON/OFF” button to start operation.
(4)	Push“ /TEST” button twice and operate in TEST OPERATION MODE for 3 minutes.
(5)	Push“ /TEST” button and operate normally.
(6)	Confirm its function according to the operation manual.

3.3 BRC082A41W, BRC982A42W(S) for FFQ

	1	1	2	3	4	5	6	7
BRC082A41W	1		1	1	1	2	1	2
BRC082A42W		1	1	1	1	2	1	2
BRC082A42S		1	1	1	1	2	1	2

	8	9	10	11	12	13
BRC082A41W	1	1	4	4	1	
BRC082A42W	1	1	3	4	1	1
BRC082A42S	1	1	3	4	1	1

Figure 1

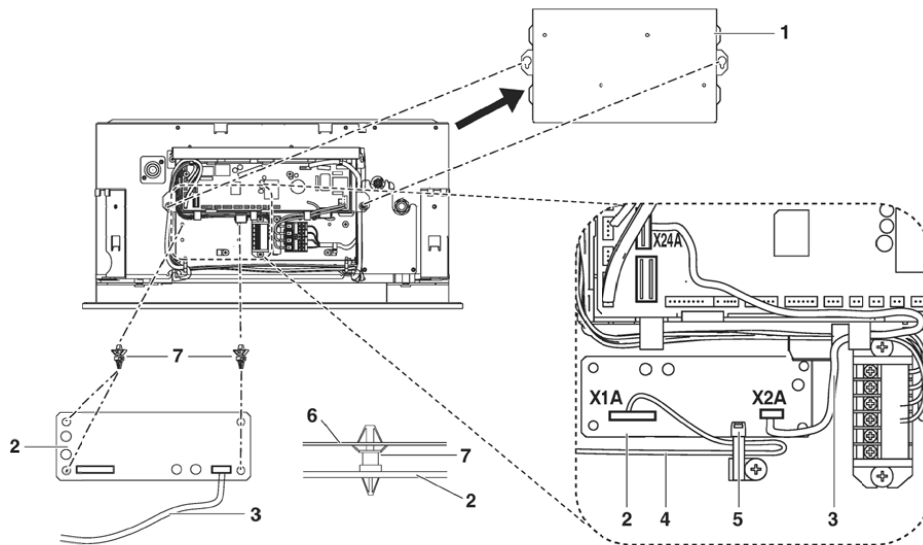

Figure 2

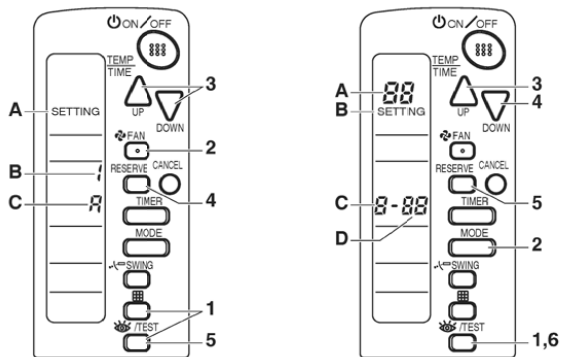

Figure 3

Figure 4

Contents

Safety considerations	1
Before installation	1
Accessories.....	1
Note to the installer.....	1
Remote controller installation	2
Installing the wireless remote controller.....	2
Determination of address and MAIN/SUB remote controller.....	2
Setting procedure.....	2
Installation of the transmitter board.....	3
Installation of the decoration panel	3
Installation of the receiver in case of BRC082A41W	4
Installation of the receiver in case of BRC082A42W/S	4
Field setting	5



READ THIS MANUAL ATTENTIVELY BEFORE STARTING UP THE UNIT. DO NOT THROW IT AWAY. KEEP IT IN YOUR FILES FOR FUTURE REFERENCE.
 IMPROPER INSTALLATION OR ATTACHMENT OF EQUIPMENT OR ACCESSORIES COULD RESULT IN ELECTRIC SHOCK, SHORTCIRCUIT, LEAKS, FIRE OR OTHER DAMAGE TO THE EQUIPMENT. BE SURE ONLY TO USE ACCESSORIES MADE BY DAIKIN WHICH ARE SPECIFICALLY DESIGNED FOR USE WITH THE EQUIPMENT AND HAVE THEM INSTALLED BY A PROFESSIONAL.
 IF UNSURE OF INSTALLATION PROCEDURES OR USE, ALWAYS CONTACT YOUR DAIKIN DEALER FOR ADVICE AND INFORMATION.

The English text is the original instruction. Other languages are translations of the original instructions.

Safety considerations

Please read this "Safety considerations" carefully before installing air conditioning equipment and be sure to install it correctly. After completing the installation, make sure at start up operation that the unit operates properly. Please instruct the customer how to operate the unit and how to perform maintenance.

Meaning of caution symbols



Failure to observe these instructions properly may result in property damage or personal injury.

Information classified as **NOTE** contains instructions to ensure proper use of the equipment.



- Refer also to the installation manual supplied with the indoor unit and the installation manual supplied with the decoration panel.
- There is only 1 possible installation position of this kit into the decoration panel. It is therefore recommended that installation orientation of the decoration panel is confirmed prior to installation of this kit.
- Ensure that nothing interrupts operation of the wireless remote controller.
- Ensure that the signal from the remote controller can easily be transmitted.
- Ensure that the operation display lamp and other indicator lamps can easily be seen.
- Ensure that there is neither a source of light nor a fluorescent lamp near the receiver.
- Ensure that the receiver is not exposed to direct sunlight.

Before installation

Accessories

See figure 1. Check if the following accessories are included with your kit.

- 1 Receiver
- 2 Transmitter board
- 3 Wireless remote controller
- 4 Remote controller holder
- 5 Alkaline battery of type AAA.LR03
- 6 Unit number label
- 7 Screw for installing remote controller holder
- 8 Installation manual
- 9 Operation manual
- 10 Clamp
- 11 Plastic spacer
- 12 Plastic band
- 13 Sealing

Note to the installer

Be sure to instruct the customer how to properly operate the system showing him/her the supplied operation manual.

Remote controller installation

Installing the wireless remote controller

- Do not throw the remote controller or subject it to powerful shocks and do not store the remote controller where it may be exposed to moisture or direct sunlight.
- When operating, point the transmitting part of the remote controller in the direction of the receiver.
- The direct transmitting distance of the remote controller is approximately 23ft (7m).
- The signal cannot be transmitted if something such as curtains blocks the receiver and the remote controller.

Installing to a wall or a pillar

- 1 Turn on all the fluorescent lamps in the room, if any, and find a location where the remote controller signals are properly received by the indoor unit (within 23ft (7m)).

- 2 Fix the remote controller holder with the supplied screws.

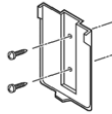

- 3 Mount the remote controller on to the hook of the remote controller holder and then push it toward the wall.

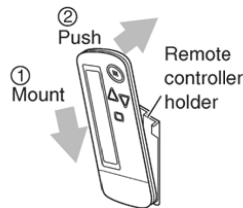

How to insert the batteries

- 1 Slide the back cover to take it off.

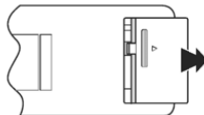

- 2 Insert 2 dry batteries AAA. LR03 (alkaline).

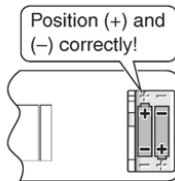

- 3 Replace the back cover.

Determination of address and MAIN/SUB remote controller

- If setting multiple wireless remote controllers to operate in one room, perform address setting for the receiver and the wireless remote controller.
- If using both a wired remote controller and a wireless remote controller with one indoor unit, change the MAIN/SUB switch of the transmitter board.

Setting procedure

Setting the transmitter board

Set the wireless address switch (SS2) on the transmitter board according to the table below.

	Unit No.		
	1	2	3
Wireless address switch (SS2)			

When using both a wired and a wireless remote controller for 1 indoor unit, the wired controller should be set to MAIN. Therefore, set the MAIN/SUB switch (SS1) of the transmitter board to SUB.

	MAIN	SUB
MAIN/SUB switch (SS1)		

Setting the address of the wireless remote controller

(See figure 3)

- A Field Set mode
- B Address (is factory set to "1")
- C Display setting

Setting from the remote controller

- 1 Hold down the button and the /TEST button for at least 4 seconds to enter the Field Set mode. (Indicated in the display area in the figure.)
- 2 Press the FAN button and select an appropriate display setting (A/B). Each time the button is pressed the display switches between "A" and "B". Refer to "Display setting A/B" on page 3 for full comprehension of this feature.
- 3 Press the button and button to set the address.



Address can be set from 1 to 6, but set it to 1-3 and to same address as the receiver. (The receiver does not work with address 4-6.)

- 4 Press the RESERVE button to confirm the setting.
- 5 Press the /TEST button to quit the Field Set mode and to return to normal display again.

Display setting *⌘*/*Ⓜ*

The wireless remote controller has 2 possible display settings. The standard setting *⌘* permanently indicates all operational items whereas the multi system display setting *Ⓜ* indicates operations for a limited period of time after execution of settings only.

In case the target indoor unit is simultaneously being controlled;

- by another unit in group control,
- by a wired remote controller,
- by a centralized remote controller.

the indoor unit sometimes does not respond to ON/OFF and temperature setting commands from the wireless remote controller.

In order not to confuse the customer with possible discrepancies between the wireless remote controller display and the actual operation state of the indoor unit, it is recommended to set the display on the wireless remote controller to *Ⓜ* in such a control configuration.

Check what setting the customer prefers and adjust the display setting accordingly.

Display setting	Remote controller display	Result of the display setting in case the target indoor unit is simultaneously being controlled by more than 1 device
<i>⌘</i> : standard	All operational items are permanently displayed.	In the operation mode changeover, temperature setting or the like are carried out from the wireless remote controller, the indoor unit rejects the instruction. (Signal receiving sound, 1 long beep or 3 short beeps) As a result, a display discrepancy between the operation state of the indoor unit and the indication on the wireless remote controller display occurs.
<i>Ⓜ</i> : multi system	Operations only remain displayed for a short time after execution of the commands.	Since the indications on the wireless remote controller are turned off, a discrepancy such as described above no longer occurs.

Affix the unit number label

Affix corresponding unit number labels onto both air outlet of the decoration panel and onto back of the wireless remote controller.

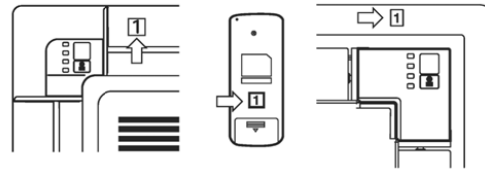

NOTE Set the Unit No. of the receiver and the wireless remote controller to be equal. If the settings differ, the signal from the remote controller cannot be transmitted.

Installation of the transmitter board

(See figure 2)

- 1 Electrical wiring box cover
- 2 Transmitter board
- 3 Shorter wire harness
- 4 Longer wire harness
- 5 Clamp
- 6 Electrical wiring box
- 7 Plastic spacer

- 1 Cut off the power supply.
- 2 Remove the electrical wiring box cover as described in the installation manual supplied with the indoor unit.
- 3 Attach four plastic spacers (7) to the transmitter board (2) and install it in the electrical wiring box (6).
- 4 Connect the shorter wire harness from the X2A connector on transmitter board (2) to X24A connector on the printed circuit board in the electrical wiring box of indoor unit. Lay down the shorter wire harness as shown in the figure 2.
- 5 When the receiver is installed bring the longer wire harness to the electrical wiring box of indoor unit and connect it to X1A connector on the transmitter board.
- 6 Clamp the wire harness by the clamp (5) as shown in the figure 2.

Installation of the decoration panel

Install the decoration panel as described in the installation manual supplied with the decoration panel.

NOTE Make sure that the wire harness (longer one) from the transmitter board is not caught between the indoor unit and the decoration panel, and between the ceiling and the decoration panel.
The installation process of the receiver depends on used decoration panel.

Installation of the receiver in case of BRC082A41W

- 1 Remove the suction grille as described in the installation manual supplied with the decoration panel.
- 2 Detach the brand name plate part of the decoration panel piece, before attaching the decoration panel. This part is not needed hereafter.
- 3 Remove the electrical wiring box cover as described in the installation manual supplied with the indoor unit. (Be sure to turn off power, before removing the electrical wiring box cover.)

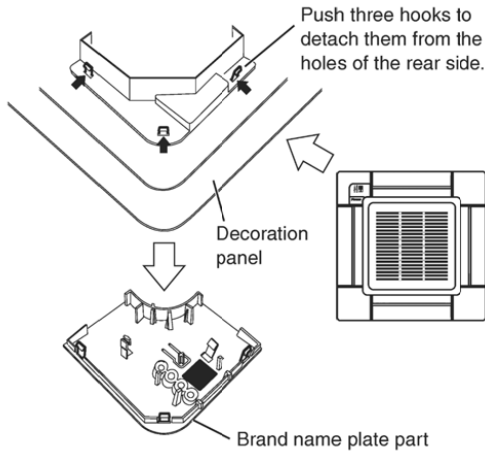

- 4 Pass the wire harness from the receiver through the wiring hole of the decoration panel. Then attach the receiver to the decoration panel. Lead the wire harness to the electrical wiring box on the indoor unit and connect it to X1A connector on the transmitter board.

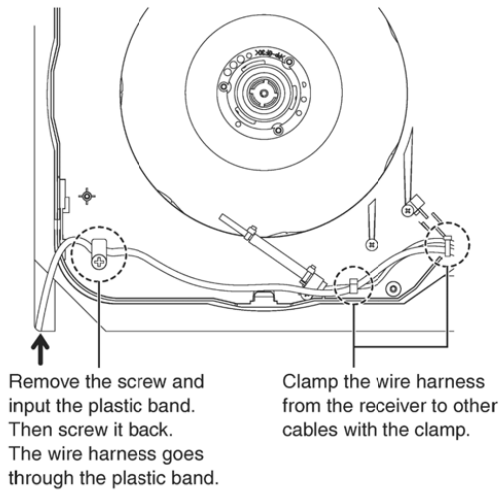
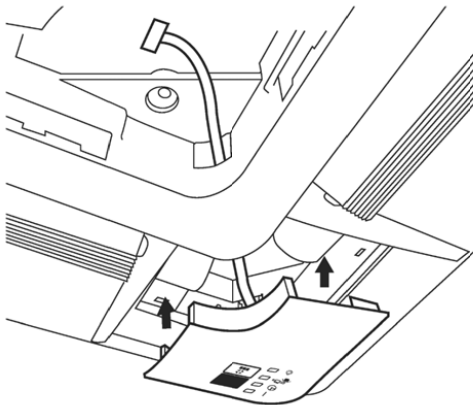

Installation of the receiver in case of BRC082A42W/S

- 1 Remove the suction grille as described in the installation manual supplied with the decoration panel.
- 2 The receiver (1) should be installed in the corner that is surrounded by 2 square marks on one side and 1 square mark on the other, as shown in the illustration. Then remove the plastic corner cover.

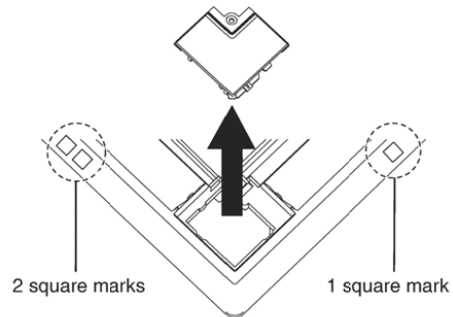

- 3 Break off the plastic cover from back side of the panel.

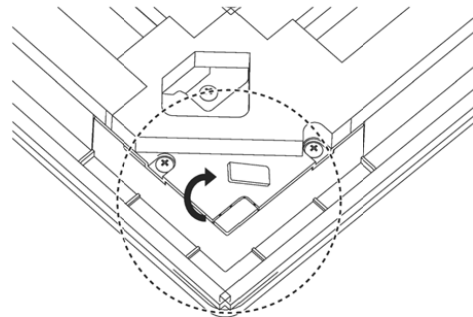

- 4 Pass the wire harness through the hole and insert the cover into its position and screw it.

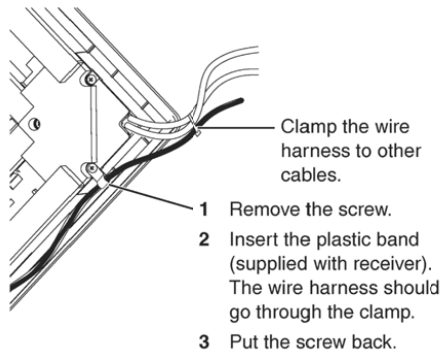
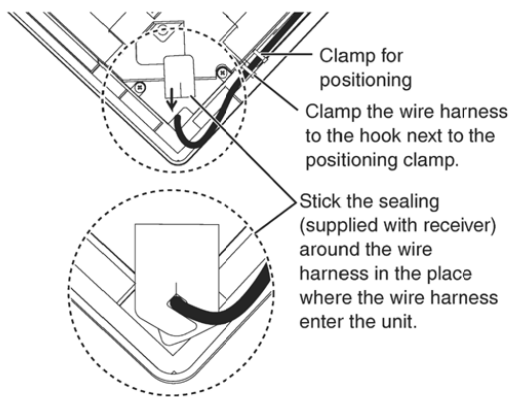
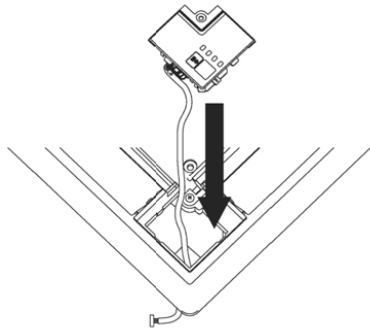





Field setting

If optional accessories are mounted on the indoor unit, the indoor unit setting may have to be changed. Refer to the instruction manual (option handbook) for each optional accessory.

(See figure 4)

- A Mode No.
- B Field Set mode
- C First code No.
- D Second code No.

Procedure

- 1 When in normal mode, hold down the /TEST button for at least 4 seconds to enter the Field Set mode.
- 2 Select the desired Mode No. with the MODE button.
- 3 Press the  button and select the First code No.
- 4 Press the  button and select the Second code No.
- 5 Press the RESERVE button to confirm the settings.
- 6 Press the /TEST button to quit the Field Set mode and to return to normal display again.

Example

If the time to clean air filter is set to "Filter Contamination-Heavy", set Mode No. to "13", First code No. to "02", and Second code No. to "02".

Mode No.	First code No.	Description of setting		Second code No.				
				01		02		03
13	01	Sets operation time until AIR FILTER CLEANING TIME INDICATOR lamp lights up. (When dirt and dust levels are high, change the setting to "Filter Contamination-Heavy".)	Long-life filter	Light	±2,500 hrs.	Heavy	±1,250 hrs.	—
	03	Changes AIR FILTER CLEANING TIME INDICATOR lamp on/off settings.		On		Off		—
13	01	Setting air outlet velocity. This setting is to be changed in function of ceiling height (H).		≤8-7/8ft (≤2.7m)	8-7/8<H≤9-13/16ft (2.7<H≤3.0m)	9-13/16<H≤11-1/2ft (3.0<H≤3.5m)		
	02	Selection of air flow direction. This setting is to be changed when blocking pad optional kit is used.		4-way flow	3-way flow	2-way flow		
	04	Airflow direction range setting. This setting is to be changed when range of swing flap movement needs to be changed.		Upper	Medium	Lower		

NOTE

Factory settings of the Second code No. are marked in grey backgrounds.

Do not use any settings not listed in the table.

For group control with a wireless remote controller, initial settings for all the indoor units of the group are equal.

(For group control, refer to the installation manual supplied with the indoor unit for group control.)

Part 3 Operation Manual

1. Operation Manual List.....	252
2. Operation Manual	254
2.1 CTXS, FTXS	254
2.2 FTXR	293
2.3 FVXS	330
2.4 CDMQ, FDMQ	366
2.5 FFQ.....	376
2.6 BRC1E73.....	388
2.7 BRC082A43 for CDMQ, FDMQ	438
2.8 BRC082A41W, BRC982A42W(S) for FFQ.....	446

1. Operation Manual List

Wall Mounted and Floor Standing

Type	Model	Operation Manual	Reference Page	Wireless R/C	Wired R/C
Wall Mounted	CTXS07WVJU9	3P674686-1	254 ★	ARC452A21	(BRC944B2) (Option)
	FTXS09WVJU9				
	FTXS12WVJU9				
	FTXS15WVJU9	3P674686-2			
	FTXS18WVJU9				
	FTXS24WVJU9				
	FTXR09WVJUW9	3P674694-1	293	ARC466A36	
	FTXR09WVJUS9				
	FTXR12WVJUW9				
	FTXR12WVJUS9				
	FTXR18WVJUW9				
	FTXR18WVJUS9				
Floor Standing	FVXS09WVJU9	3P674699-1	330	ARC466A21	—
	FVXS12WVJU9				
	FVXS15WVJU9				
	FVXS18WVJU9				

★ Illustration is for FTXS15WVJU9 as representative.

Duct Concealed and Ceiling Cassette

Type	Model	Operation Manual for Body Unit	Reference Page	Wireless R/C	Reference Page	Wired R/C	Reference Page
Duct Concealed	CDMQ07WVJU9	3P674692-1	366	BRC082A43	438	BRC1E73	388
	FDMQ09WVJU9						
	FDMQ12WVJU9						
	FDMQ15WVJU9						
	FDMQ18WVJU9						
	FDMQ24WVJU9						
Ceiling Cassette	FFQ09W2VJU9	3P674698-1	376	BRC082A41W BRC082A42W(S)	446		
	FFQ12W2VJU9						
	FFQ15W2VJU9						
	FFQ18W2VJU9						

2. Operation Manual

2.1 CTXS, FTXS

Safety Considerations

Refer also to the General Safety Considerations in the separate booklet.



Read the precautions in this manual carefully before operating the unit.

Read these **Safety Considerations for Operations** carefully before operating an air conditioner or heat pump.

Make sure that the unit operates properly during the startup operation. Instruct the user on how to operate and maintain the unit.

Inform users that they should store this operation manual with the installation manual for future reference.

Meanings of **DANGER**, **WARNING**, **CAUTION**, and **NOTE**

Symbols:

⚠ DANGER Indicates an imminently hazardous situation which, if not avoided, will result in death or serious injury.

⚠ WARNING Indicates a potentially hazardous situation which, if not avoided, could result in death or serious injury.

⚠ CAUTION Indicates a potentially hazardous situation which, if not avoided, may result in minor or moderate injury. It may also be used to alert against unsafe practices.

⚠ NOTE Indicates situations that may result in equipment or property damage accidents only.

— ⚠ DANGER —

- Do not install the unit in an area where flammable materials are present due to risk of explosion resulting in serious injury or death.
- Any abnormalities in the operation of the air conditioner or heat pump, such as smoke or fire, could result in severe injury or death. Turn off the power and contact your dealer immediately.
- Refrigerant gas may produce toxic gas if it comes into contact with fire, such as from a fan heater, stove, or cooking device. Exposure to this gas could cause severe injury or death.
- For refrigerant leakage, consult your dealer. Refrigerant gas is heavier than air and replaces oxygen. A massive leak could lead to oxygen depletion, especially in basements, and an asphyxiation hazard could occur leading to serious injury or death.
- If equipment utilizing a burner is used in the same room as the air conditioner or heat pump, there is the danger of oxygen deficiency which could lead to an asphyxiation hazard resulting in serious injury or death. Be sure to ventilate the room sufficiently to avoid this hazard.
- Safely dispose of the packing materials. Packing materials, such as nails and other metal or wooden parts, may cause stabs or other injuries.
- Tear apart and throw away plastic packaging bags so that children will not play with them. Children playing with plastic bags face the danger of death by suffocation.

— ⚠ WARNING —

- Contact your dealer for repair and maintenance. Improper repair and maintenance may result in water leakage, electric shock, and fire. Only use accessories made by Daikin that are specifically designed for use with the equipment and have them installed by a professional.
- Contact your dealer to move and reinstall the air conditioner or heat pump. Incomplete installation may result in water leakage, electric shock, and fire.
- Never let the indoor unit or the remote controller get wet. Water can cause an electric shock or a fire.
- Never use flammable spray such as hair spray, lacquer, or paint near the unit. Flammable spray may cause a fire.
- When a fuse blows out, never replace it with one of incorrect ampere ratings or different wires. Always replace any blown fuse with a fuse of the same specification.
- Never remove the fan guard of the unit. A fan rotating at high speed without the fan guard is very dangerous.
- Never inspect or service the unit by yourself. Contact a qualified service person to perform this work.
- Turn off all electrical power before doing any maintenance to avoid the risk of serious electric shock; never sprinkle or spill water or liquids on the unit.
- Do not touch the switch with wet fingers. Touching a switch with wet fingers can cause electric shock.
- Do not allow children to play on or around the unit to prevent injury.
- The heat exchanger fins are sharp enough to cut. To avoid injury wear gloves or cover the fins while working around them.
- Do not put a finger or other objects into the air inlet or air outlet. The fan is rotating at high speed and will cause injury.
- Check the unit foundation for damage on a continuous basis, especially if it has been in use for a long time. If left in a damaged condition the unit may fall and cause injury.
- Placing a flower vase or other containers with water or other liquids on the unit could cause a shock or fire if a spill occurs.
- Do not touch the air outlet or horizontal blades while the swing flap is in operation because fingers could get caught and injured.
- Never touch the internal parts of the controller. Do not remove the front panel because some parts inside are dangerous to touch. To check and adjust internal parts, contact your dealer.
- Do not use means to accelerate the defrosting process or to clean, other than those recommended by the manufacturer.
- The appliance must be stored in a room without continuously operating ignition sources (for example: open flames, an operating gas appliance or an operating electric heater).
- Do not pierce or burn.
- Be aware that refrigerants may not contain an odor.

⚠ CAUTION

- Do not use the air conditioner or heat pump for any other purposes other than comfort cooling or heating. Do not use the unit for cooling precision instruments, food, plants, animals or works of art.
- Do not place items under the indoor unit as they may be damaged by condensates that may form if the humidity is above 80% or if the drain outlet gets blocked.
- Before cleaning, stop the operation of the unit by turning the power off or by pulling the supply cord out from its receptacle. Otherwise, an electric shock and injury may result.
- Do not wash the air conditioner or heat pump with excessive water. An electric shock or fire may result.
- Avoid placing the controller in a spot which may be splashed with water. Water entering the controller may cause an electric shock or damage the internal electronic parts.
- Do not operate the air conditioner or heat pump when using a room-fumigation type of insecticide. Failure to observe this could cause the chemicals to be deposited in the unit and can endanger the health of those who are hypersensitive to chemicals.
- Do not turn off the power immediately after stopping operation. Always wait for at least 5 minutes before turning off the power. Otherwise, water leakage may occur.
- The appliance is not intended for use by young children or infirm persons without supervision.
- The remote controller should be kept away from children so they cannot play with it.
- Consult with the installation contractor for cleaning.
- Incorrect cleaning of the inside of the air conditioner or heat pump could make the plastics parts break and cause water leakage or electric shock.
- Do not touch the air inlet or aluminum fin of the air conditioner or heat pump as they can cut and cause injury.
- Do not place objects in direct proximity of the outdoor unit. Do not let leaves and other debris accumulate around the unit. Leaves are a hotbed for small animals which can enter the unit. Once inside the unit, animals can cause the unit to malfunction, and cause smoke or fire when they make contact with electrical parts.
- Do not wipe the controller operation panel with benzine, thinner, chemical dust cloth, etc. The panel may get discolored or the coating can peel off. If it is heavily dirty, soak a cloth in water-diluted neutral detergent, squeeze it well and wipe the panel clean. Then wipe it with another dry cloth.
- Dismantling of the unit, disposal of the refrigerant, oil, and additional parts, should be done in accordance with the relevant local, state, and national regulations.
- Operate the air conditioner or heat pump in a sufficiently ventilated area and not surrounded by obstacles. Do not use the air conditioner or heat pump in the following places.
 - a. Places with a mist of mineral oil, such as cutting oil.
 - b. Locations such as coastal areas where there is a lot of salt in the air.
 - c. Locations such as hot springs where there is a lot of sulfur in the air.
 - d. Locations such as factories where the power voltage varies a lot.
 - e. In cars, boats, and other vehicles.
 - f. Locations such as kitchens where oil may splatter or where there is steam in the air.
 - g. Locations where equipment produces electromagnetic waves.
 - h. Places with an acid or alkaline mist.
 - i. Places where fallen leaves can accumulate or where weeds can grow.
- Take snow protection measures. Contact your dealer for the details of snow protection measures, such as the use of a snow protection hood.
- Do not attempt to do electrical work or grounding work unless you are licensed to do so. Consult with your dealer for electrical work and grounding work.
- Pay attention to operating sound. Be sure to use the following places:
 - a. Places that can sufficiently withstand the weight of the air conditioner or heat pump yet can suppress the operating sound and vibration.
 - b. Places where warm air from the air outlet of the outdoor unit or the operating sound of the outdoor unit does not annoy neighbors.
- Make sure that there are no obstacles close to the outdoor unit. Obstacles close to the outdoor unit may drop the performance of the outdoor unit or increase the operating sound of the outdoor unit.
- Consult your dealer if the air conditioner or heat pump in operation generates unusual noise.
- Make sure that the drainpipe is installed properly to drain water. If no water is discharged from the drainpipe while the air conditioner or heat pump is in the cooling mode, the drainpipe may be clogged with dust or dirt and water leakage from the indoor unit may occur. Stop operating the air conditioner or heat pump and contact your dealer.
- Do not spray the air conditioner unit with any deodorizers, etc. It may cause the unit to malfunction.

⚠ NOTE

- Never press the button of the remote controller with a hard, pointed object. The remote controller may be damaged.
- Never pull or twist the electric wire of the remote controller. It may cause the unit to malfunction.
- Do not place appliances that produce open flames in places that are exposed to the airflow of the unit or under the indoor unit. It may cause incomplete combustion or deformation of the unit due to the heat.
- Do not expose the controller to direct sunlight. The LCD display can become discolored and may fail to display the data.

FTP002M-U

Names of Parts

Indoor Unit

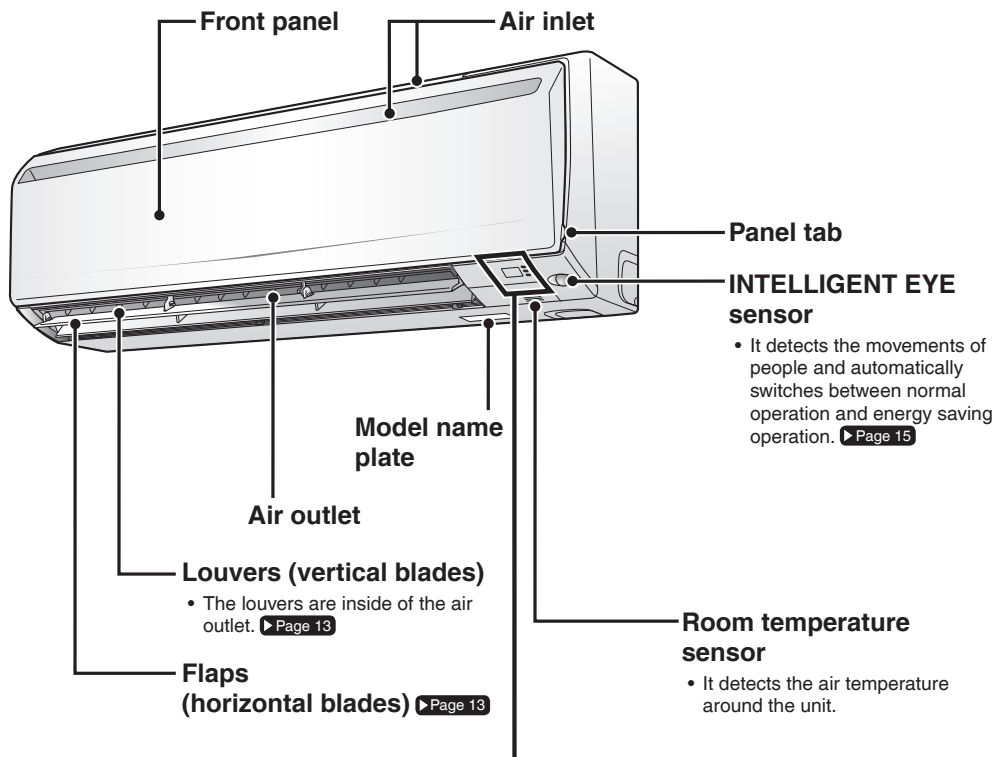

Display

Signal receiver

- It receives signals from the remote controller.
- When the unit receives a signal, you will hear a beep sound.

Case	Sound type
Operation start	beep-beep
Setting changed	beep
Operation stop	long beep

OPERATION lamp (green)

TIMER lamp (orange) ▶ Page 20,21

INTELLIGENT EYE lamp (green) ▶ Page 15,16

ON/OFF

Indoor unit ON/OFF switch

- Press this switch once to start operation. Press once again to stop it.
- The operation mode refer to the following table.

Mode	Temperature setting	Airflow rate
AUTO	77°F (25°C)	AUTO

- This switch is useful when the remote controller is missing.

■ Open the front panel

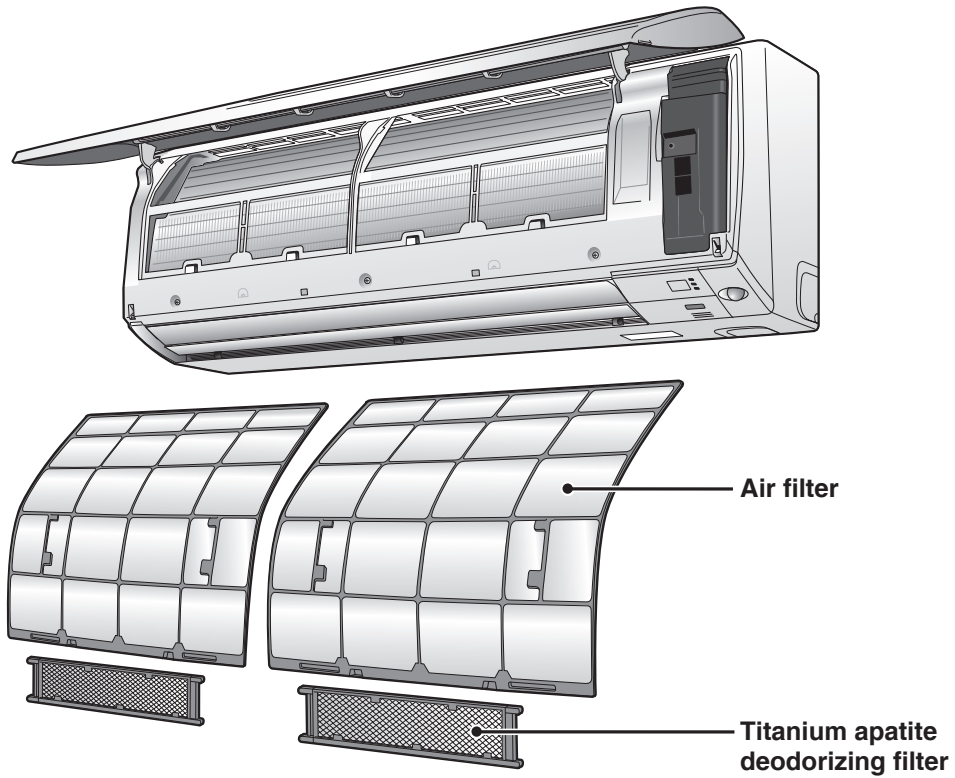

Outdoor Unit

• Appearance of the outdoor unit may differ from some models.

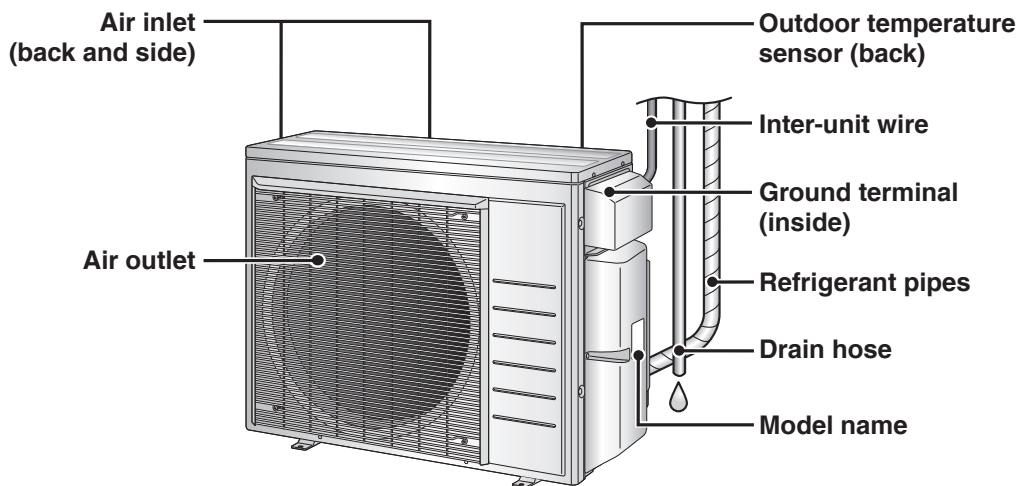

Names of Parts

Remote Controller

Signal transmitter

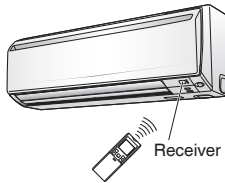

- To use the remote controller, aim the transmitter at the indoor unit. If there is anything to block signals between the unit and the remote controller, such as a curtain, the unit will not operate.
- Do not drop the remote controller. Do not get it wet.
- The maximum distance for communication is approximately 23ft (7m).

FAN setting button

- Selects the airflow rate setting. [▶ Page 14](#)

POWERFUL button

- POWERFUL operation. [▶ Page 17](#)

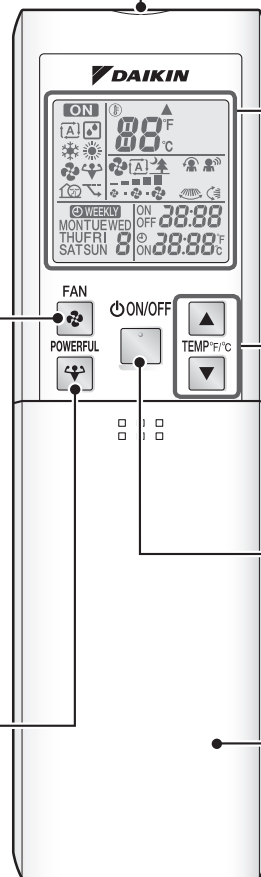

Display (LCD)

- Displays the current settings. (In this illustration, each section is shown with all its displays on for the purpose of explanation.)

TEMPERATURE adjustment buttons

- Changes the temperature setting. [▶ Page 12](#)

ON/OFF button

- Press this button once to start operation. Press once again to stop it. [▶ Page 11](#)

Front cover

- Open the front cover. [▶ Page 8](#)

<ARC452A21>

■ Open the front cover

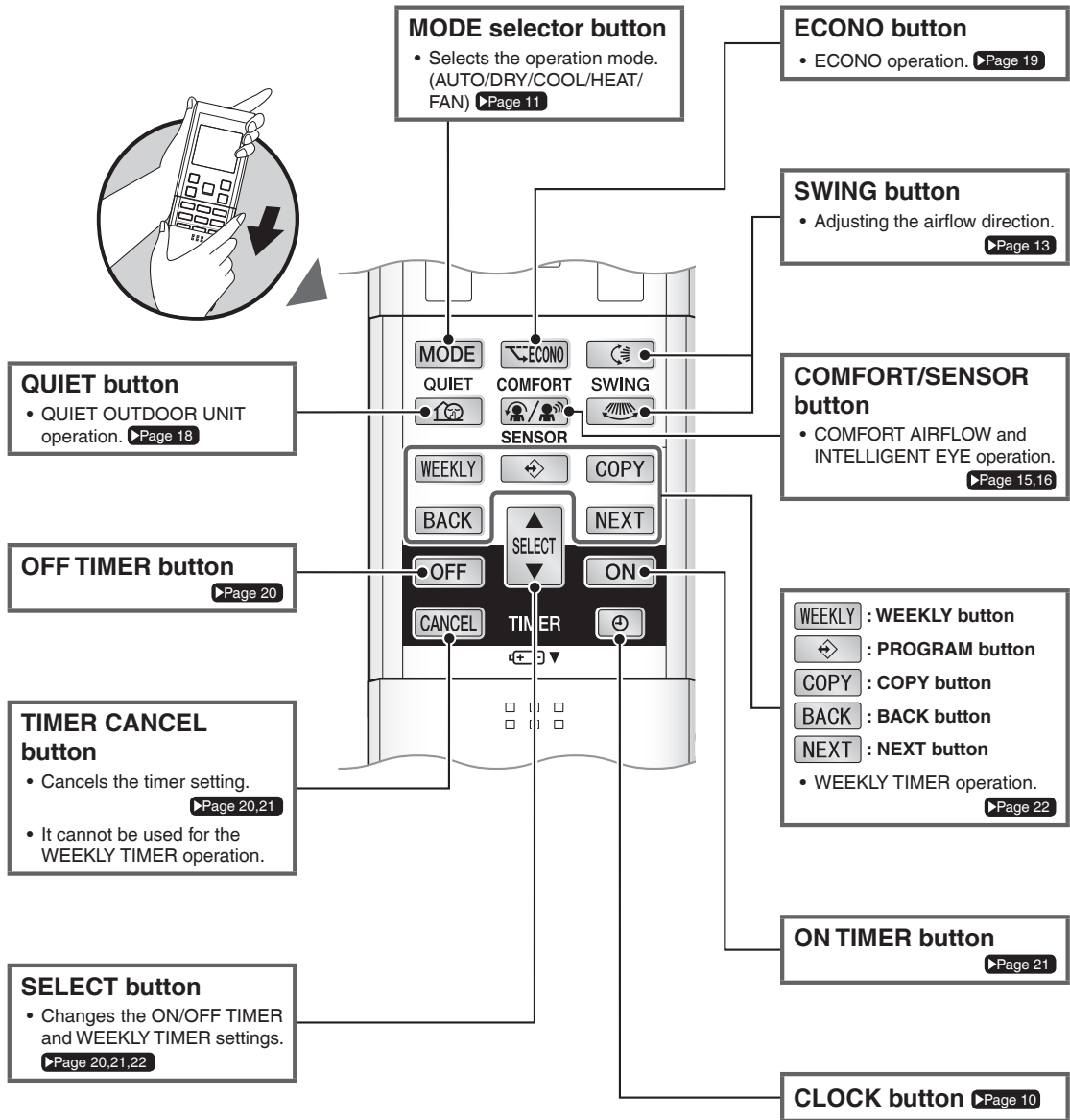

Preparation Before Operation

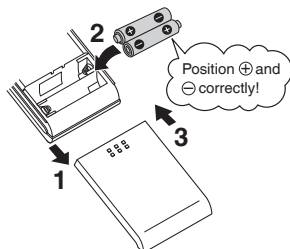

■ To set the batteries

1. Slide the front cover to take it off.
2. Set two dry batteries AAA.LR03 (alkaline).
3. Set the front cover as before.

■ To fix the remote controller holder to a wall

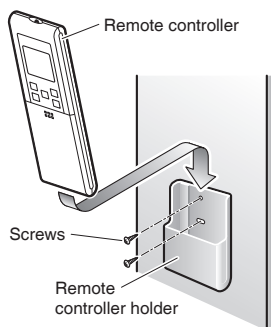

1. Choose a place from where the signals reach the unit.
2. Fix the holder to a wall, a pillar, etc. with the screws supplied with the holder.
3. Place the remote controller in the remote controller holder.

■ Celsius/Fahrenheit display switch

- The Celsius or Fahrenheit display is selectable with the following buttons.

Press  and  simultaneously for 5 seconds.

- The temperature will be displayed in Fahrenheit if it is presently displayed in Celsius, and vice versa.

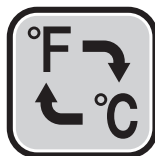

NOTE

■ Notes on batteries

- When replacing the batteries, use batteries of the same type, and replace both batteries at the same time.
- When the system is not used for a long time, take the batteries out.
- The batteries will last for approximately 1 year. If the remote controller display begins to fade and the degradation of reception performance occurs within a year, however, replace both batteries with new, size AAA.LR03 (alkaline).
- The attached batteries are provided for the initial use of the system.
The usable period of the batteries may be short depending on the manufactured date of the air conditioner.

■ Notes on remote controller

- Never expose the remote controller to direct sunlight.
- Dust on the signal transmitter or receiver will reduce the sensitivity. Wipe off dust with a soft cloth.
- Signal communication may be disabled if an electronic-starter-type fluorescent lamp (such as inverter-type lamps) is in the room. Consult the shop if that is the case.
- If the remote controller signals happen to operate another appliance, move that appliance somewhere else, or consult your dealer.

■ Celsius/Fahrenheit display change function of remote controller

- The set temperature may increase when the display is changed to Celsius from Fahrenheit, because a fraction of 0.5°C is rounded up.
- Example: A set temperature of 65°F (equivalent to 18.5°C) will be converted into 19°C.
When the display is changed to Fahrenheit again, the set temperature will be converted into 66°F (equivalent to 19°C) instead of the original set temperature (65°F) but a set temperature of 66°F (equivalent to 19°C) will be converted into 19°C with no temperature change.
- A reception sound will go off for the transmission of set temperature to the indoor unit at the time of setting the Celsius/Fahrenheit display change function.

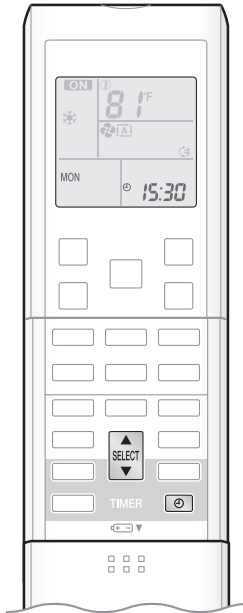

■ Turn the circuit breaker on

- After the power is turned on, the flaps of the indoor unit open and close once to set the reference position.

■ To set the clock

1. Press .





“0:00” is displayed.
“MON” and “” blink.



2. Press  to set the current day of the week.

3. Press .



“” blinks.

4. Press  to set the clock to the present time.

- Holding down  or  rapidly increases or decreases the time display.

5. Press .

- Point the remote controller at the indoor unit when pressing the buttons.



“.” blinks.



AUTO · DRY · COOL · HEAT · FAN Operation

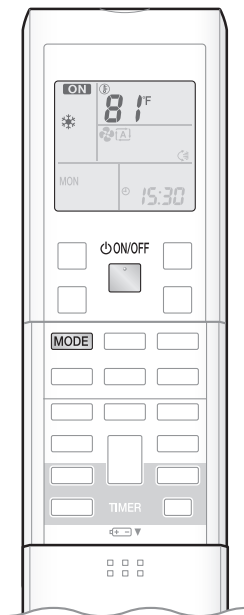

The air conditioner operates with the operation mode of your choice. From the next time on, the air conditioner will operate with the same operation mode.

■ To start operation

1. Press **MODE** and select an operation mode.

- Each pressing of the button advances the mode setting in sequence.

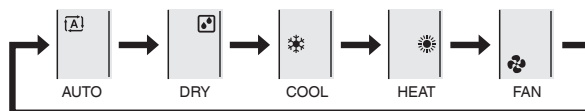

2. Press .

- “**ON**” is displayed on the LCD.
- The OPERATION lamp lights green.



Display

■ To stop operation

Press again.



- “**ON**” is no longer displayed on the LCD.
- The OPERATION lamp goes off.

NOTE

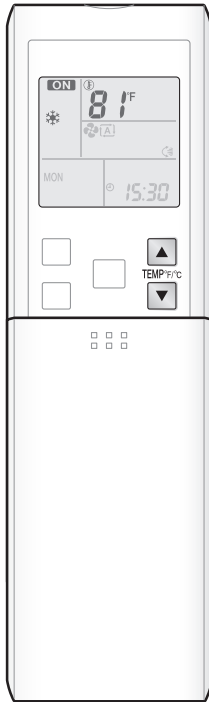
MODE	Notes on each operation mode
HEAT	<ul style="list-style-type: none"> • Since this air conditioner heats the room by taking heat from outdoor air to indoors, the heating capacity becomes smaller in lower outdoor temperatures. If the heating effect is insufficient, it is recommended to use another heating appliance in combination with the air conditioner. • The heat pump system heats the room by circulating hot air around all parts of the room. After the start of HEAT operation, it takes some time before the room gets warmer. • In HEAT operation, frost may occur on the outdoor unit and lower the heating capacity. In that case, the system switches into defrosting operation to take away the frost. • During defrosting operation, hot air does not flow out of indoor unit.
COOL	<ul style="list-style-type: none"> • This air conditioner cools the room by releasing the heat in the room outside. Therefore, the cooling performance of the air conditioner may be degraded if the outdoor temperature is high.
DRY	<ul style="list-style-type: none"> • The computer chip works to rid the room of humidity while maintaining the temperature as much as possible. It automatically controls temperature and airflow rate, so manual adjustment of these functions is unavailable.
AUTO	<ul style="list-style-type: none"> • In AUTO operation, the system selects an appropriate operation mode (COOL or HEAT) based on the room and outside temperatures and starts the operation. • The system automatically reselects setting at a regular interval to bring the room temperature to user-setting level.
FAN	<ul style="list-style-type: none"> • This mode is valid for fan only.



■ To change the temperature setting

Press  or  .

- The displayed items on the LCD will change whenever either one of the buttons is pressed.

COOL operation	HEAT operation	AUTO operation	DRY or FAN operation
64-90°F (18-32°C)	50-86°F (10-30°C)	64-86°F (18-30°C)	The temperature setting cannot be changed.
Press ▲ to raise the temperature and press ▼ to lower the temperature.			

Tips for saving energy

Keeping the temperature setting at a moderate level helps save energy.

- Recommended temperature setting
 - For cooling: 78-82°F (26-28°C)
 - For heating: 68-75°F (20-24°C)

Cover windows with a blind or a curtain.

- Blocking sunlight and air from outdoors increases the cooling (heating) effect.

Keep the air filters clean.

- Clogged air filters cause inefficient operation and waste energy. Clean them once in about every 2 weeks. ▶ Page 32

If you are not going to use the air conditioner for a long period, for example in spring or autumn, turn off the circuit breaker.

- The air conditioner always consumes a small amount of electricity even while it is not operating.





Adjusting the Airflow Direction and Rate

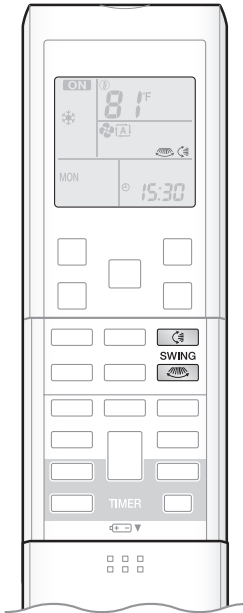

You can adjust the airflow direction to increase your comfort.

■ To start auto swing

Upper and lower airflow direction

Press .

- “” is displayed on the LCD.
- The flaps (horizontal blades) will begin to swing.

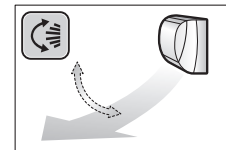

Right and left airflow direction

Press .

- “” is displayed on the LCD.
- The louvers (vertical blades) will begin to swing.

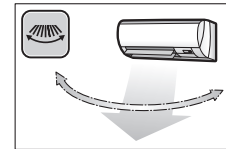

The 3-D airflow direction

Press and .

- “” and “” are displayed on the LCD.
 - The flaps and louvers move in turn.
 - To cancel 3-D airflow, press either or again.
- The flaps or louvers will stop moving.

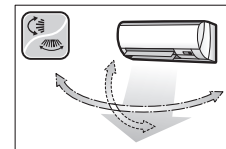

■ To set the flaps or louvers at the desired position

- This function is effective while flaps or louvers are in auto swing mode.

Press and when the flaps or louvers reach the desired position.

- In the 3-D airflow, the flaps and louvers move in turn.
- “” or “” disappears from the LCD.

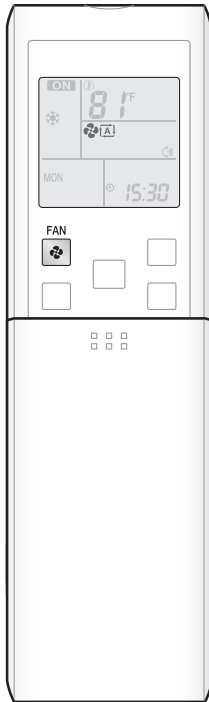

■ To adjust the airflow rate setting

Press .

- Each pressing of  advances the airflow rate setting in sequence.

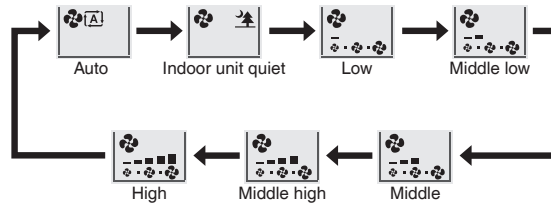

- When the airflow is set to “”, indoor unit quiet operation will start and the noise from the unit will become quieter.
- In indoor unit quiet operation, the airflow rate is set to a weak level.
- In DRY operation, the airflow rate setting cannot be changed.

NOTE

■ Notes on the angles of the flaps

- The flaps swinging range depends on the operation. (See the figure.)

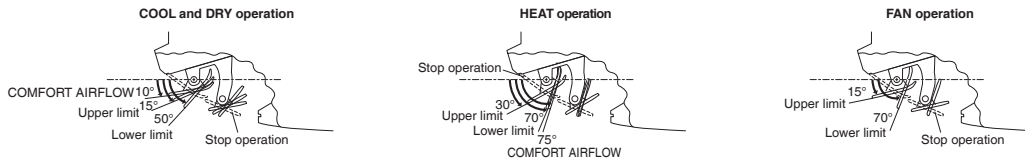

■ Note on 3-D airflow

- Using 3-D airflow circulates cold air, which tends to be collected at the bottom of the room, and hot air, which tends to collect near the ceiling, throughout the room, preventing areas of cold and hot developing.

■ Note on airflow rate setting

- At smaller airflow rates, the cooling (heating) effect is also smaller.

⚠ CAUTION

- Always use a remote controller to adjust the angles of the flaps and louvers.
 - If you attempt to move the flaps and louvers forcibly by hand when they are swinging, the mechanism may be damaged.
 - Inside the air outlet, a fan is rotating at a high speed.



COMFORT AIRFLOW / INTELLIGENT EYE Operation

COMFORT AIRFLOW operation

The flow of air will be in the upward direction while in COOL operation and in the downward direction while in HEAT operation, which will provide a comfortable airflow that will not come in direct contact with people.

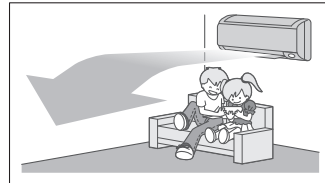

COOL operation

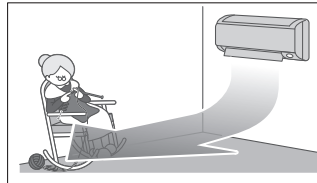

HEAT operation

INTELLIGENT EYE operation

“INTELLIGENT EYE” is the infrared sensor which detects the human movement.

If no one is in the room for more than 20 minutes, the operation automatically changes to energy saving operation.

[Example]

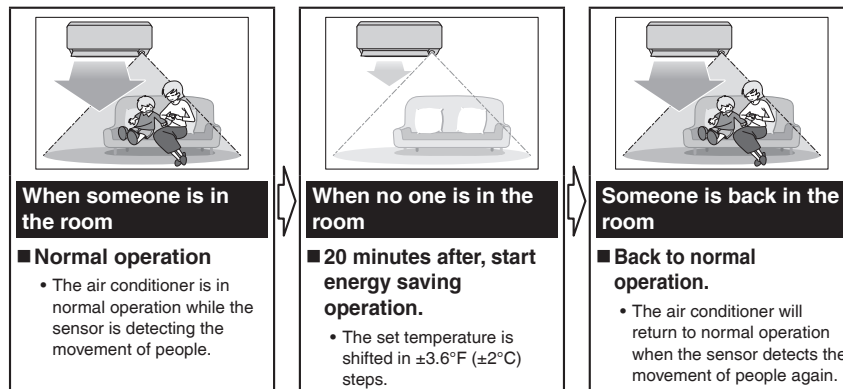

INTELLIGENT EYE operation is useful for energy saving

Energy saving operation

- If no presence is detected in the room for 20 minutes, the energy saving operation will start, and the INTELLIGENT EYE lamp goes off. If human movement is detected again, the INTELLIGENT EYE lamp lights up and energy saving operation terminates.
- This operation changes the temperature -3.6°F (-2°C) in HEAT / $+3.6^{\circ}\text{F}$ ($+2^{\circ}\text{C}$) in COOL / $+3.6^{\circ}\text{F}$ ($+2^{\circ}\text{C}$) in DRY operation from set temperature. When the room temperature exceeds 86°F (30°C), the operation changes the temperature $+1.8^{\circ}\text{F}$ ($+1^{\circ}\text{C}$) in COOL / $+1.8^{\circ}\text{F}$ ($+1^{\circ}\text{C}$) in DRY operation from set temperature.
- This operation decreases the airflow rate slightly in FAN mode only.

Combination COMFORT AIRFLOW and INTELLIGENT EYE operation

The air conditioner can go into operation with the COMFORT AIRFLOW and INTELLIGENT EYE functions combined.

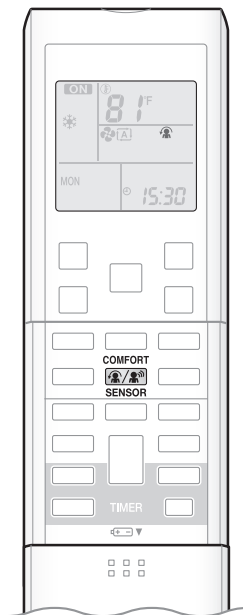



■ To start operation

Press  and select the desired mode.

- Each time the  is pressed a different setting option is displayed on the LCD.
- When INTELLIGENT EYE is selected, the INTELLIGENT EYE lamp lights green.



Display

- By selecting " " from the following icons, the air conditioner will be in COMFORT AIRFLOW operation combined with INTELLIGENT EYE operation.



- When the flaps (horizontal blades) are swinging, selecting any of the modes above will cause the flaps (horizontal blades) to stop.

■ To cancel operation

Press  and select "blank" on the LCD.

- If the INTELLIGENT EYE operation was being used, the INTELLIGENT EYE lamp goes off.

NOTE

■ Notes on COMFORT AIRFLOW operation

- The position of the flaps will change, preventing air from blowing directly on the occupants of the room.
- POWERFUL operation and COMFORT AIRFLOW operation cannot be used at the same time. Priority is given to the function of whichever button is pressed last.
- The airflow rate will be set to AUTO. If the upper and lower airflow direction is selected, the COMFORT AIRFLOW function will be canceled.

■ Notes on INTELLIGENT EYE operation

- Application range is as follows.

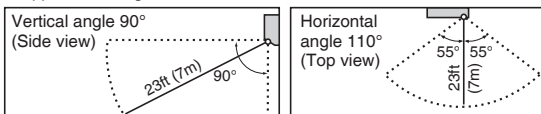

- Sensor may not detect moving objects further than 23ft (7m) away. (Check the application range)
- Sensor detection sensitivity changes according to indoor unit location, the speed of passersby, temperature range, etc.
- The sensor also mistakenly detects pets, sunlight, fluttering curtains and light reflected off of mirrors as passersby.
- INTELLIGENT EYE operation will not go on during POWERFUL operation.
- NIGHT SET mode [▶Page 20](#) will not go on during use of INTELLIGENT EYE operation.

■ Notes on combination of COMFORT AIRFLOW operation and INTELLIGENT EYE operation

- The airflow rate will be set to AUTO. If the upper and lower airflow direction is selected, the COMFORT AIRFLOW operation will be canceled. Priority is given to the function of whichever button is pressed last.

⚠ CAUTION

- Do not place large objects near the sensor.
Also keep heating units or humidifiers outside the sensor's detection area. This sensor can detect undesirable objects.
- Do not hit or violently push the INTELLIGENT EYE sensor. This can lead to damage and malfunction.



POWERFUL Operation

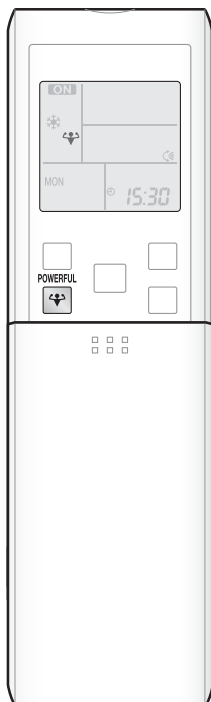

POWERFUL operation quickly maximizes the cooling (heating) effect in any operation mode. In this mode, the air conditioner operates at maximum capacity.

■ To start POWERFUL operation

Press  during operation.

- “” is displayed on the LCD.
- POWERFUL operation ends in 20 minutes. Then the system automatically operates again with the previous settings which were used before POWERFUL operation.

■ To cancel POWERFUL operation

Press  again.

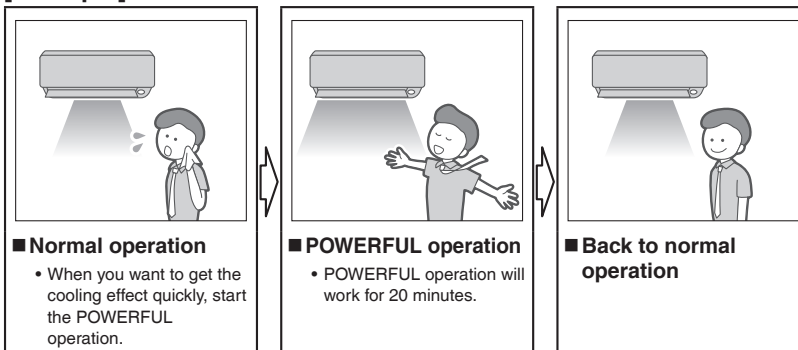

- “” is no longer displayed on the LCD.

[Example]



NOTE

■ Notes on POWERFUL operation

- When using POWERFUL operation, there are some functions which are not available.
- POWERFUL operation cannot be used together with ECONO, COMFORT AIRFLOW or QUIET OUTDOOR UNIT operation. Priority is given to the function of whichever button is pressed last.
- POWERFUL operation can only be set when the unit is running. Pressing  causes the settings to be canceled, and “” is no longer displayed on the LCD.
- POWERFUL operation will not increase the capacity of the air conditioner if the air conditioner is already in operation with its maximum capacity demonstrated.
- **In COOL, HEAT and AUTO operation**
To maximize the cooling (heating) effect, the capacity of outdoor unit increases and the airflow rate becomes fixed at the maximum setting. The temperature and airflow settings cannot be changed.
- **In DRY operation**
The temperature setting is lowered by 4.5°F (2.5°C) and the airflow rate is slightly increased.
- **In FAN operation**
The airflow rate is fixed to the maximum setting.



QUIET OUTDOOR UNIT Operation

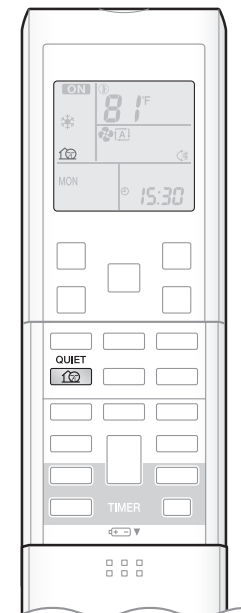

QUIET OUTDOOR UNIT operation lowers the noise level of the outdoor unit by changing the frequency and fan speed on the outdoor unit. This function is convenient during the night.

■ To start QUIET OUTDOOR UNIT operation

Press .

- “” is displayed on the LCD.

■ To cancel QUIET OUTDOOR UNIT operation

Press  again.

- “” is no longer displayed on the LCD.

[Example] Using the QUIET OUTDOOR UNIT operation during the night.

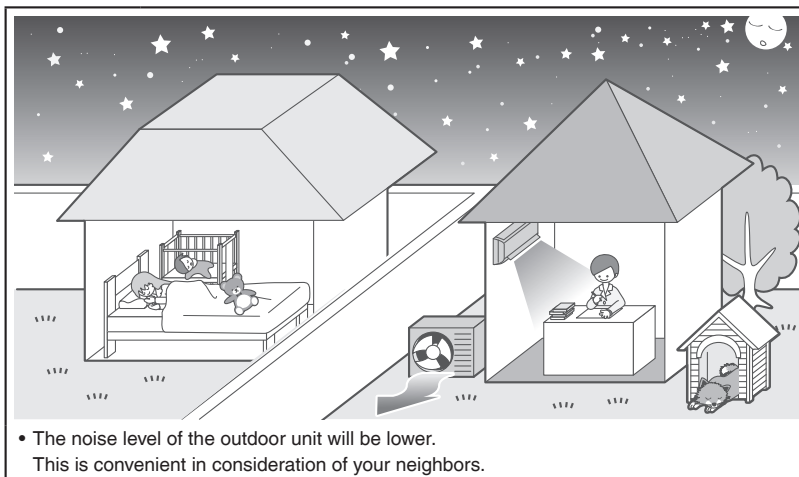

NOTE

■ Notes on QUIET OUTDOOR UNIT operation

- If using a multi system, the QUIET OUTDOOR UNIT operation will work only when this function is set on all operated indoor units. However, if using priority room setting, refer to “Note for multi system”. ▶Page 28
- This function is available in COOL, HEAT, and AUTO operation.
This is not available in FAN and DRY operation.
- POWERFUL operation and QUIET OUTDOOR UNIT operation cannot be used at the same time.
Priority is given to the function of whichever button is pressed last.
- Even the operation is stopped using the remote controller or the indoor unit ON/OFF switch when using QUIET OUTDOOR UNIT operation, “” will remain on the remote controller display.
- QUIET OUTDOOR UNIT operation will drop neither the frequency nor fan speed if they have been already dropped low enough.



ECONO Operation

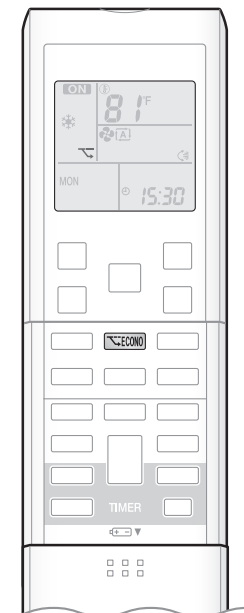

ECONO operation is a function which enables efficient operation by limiting the maximum power consumption value. This function is useful for cases in which attention should be paid to ensure a circuit breaker will not trip when the product runs alongside other appliances.

To start ECONO operation

Press  during operation.

- "ECONO" is displayed on the LCD.

To cancel ECONO operation

Press  again.

- "ECONO" is no longer displayed on the LCD.

[Example]

Normal operation



- In case the air conditioner and other appliances which require high power consumption are used at same time, a circuit breaker may trip if the air conditioner operate with its maximum capacity.

ECONO operation



- The maximum power consumption of the air conditioner is limited by using ECONO operation. The circuit breaker is unlikely to trip even if the air conditioner and other appliances are used at same time.

Running current and power consumption

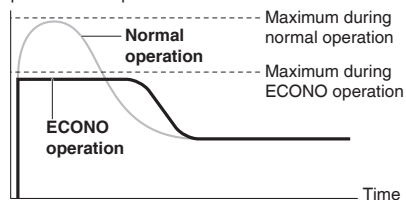

From start up until set temperature is reached

- This diagram is a representation for illustrative purposes only. The maximum running current and power consumption of the air conditioner in ECONO operation vary with the connecting outdoor unit.

NOTE

Notes on ECONO operation

- ECONO operation can only be set when the unit is running. Pressing  causes the settings to be canceled, and "ECONO" is no longer displayed on the LCD.
- ECONO operation functions in AUTO, COOL, DRY, and HEAT operation.
- POWERFUL and ECONO operation cannot be used at the same time. Priority is given to the function of whichever button is pressed last.
- If the level of power consumption is already low, ECONO operation will not drop the power consumption.



OFF TIMER Operation

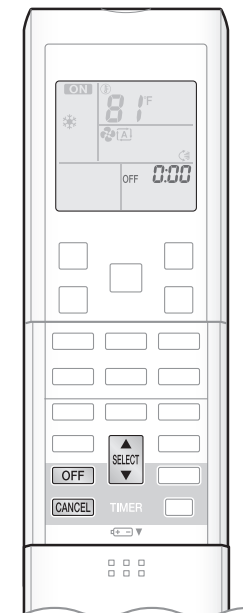

Timer functions are useful for automatically switching the air conditioner on or off at night or in the morning. You can also use OFF TIMER and ON TIMER in combination.

■ To use OFF TIMER operation

- Check that the clock is correct.
If not, set the clock to the present time. ▶Page 10

1. Press **OFF**.



"0:00" is displayed on the LCD.
"OFF" blinks.

- "⊕" is no longer displayed on the LCD.

2. Press **SELECT** until the time setting reaches the point you like.

- Each pressing of either button increases or decreases the time setting by 10 minutes. Holding down either button changes the time setting rapidly.

3. Press **OFF** again.

- "OFF" and setting time are displayed on the LCD.
- The TIMER lamp lights orange.



Display

■ To cancel OFF TIMER operation

Press **CANCEL**.

- "OFF" and setting time are no longer displayed on the LCD.
- "⊕" and day of the week are displayed on the LCD.
- The TIMER lamp goes off.

NOTE

■ Notes on TIMER operation

- When TIMER is set, the present time is not displayed.
- Once you set ON/OFF TIMER, the time setting is kept in the memory. The memory is canceled when remote controller batteries are replaced.
- When using the ON/OFF TIMER to start/stop operation, the actual operation start/stop time may differ from the time set. (Maximum of about 10 minutes)

■ NIGHT SET mode

- When the OFF TIMER is set, the air conditioner automatically adjusts the temperature setting (0.9°F (0.5°C) up in COOL, 3.6°F (2.0°C) down in HEAT) to prevent excessive cooling (heating) for your pleasant sleep.

ON 6:00 ON TIMER Operation

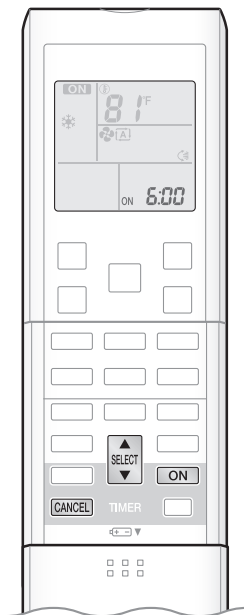

■ To use ON TIMER operation

- Check that the clock is correct.
If not, set the clock to the present time. ▶Page 10

1. Press **ON**.

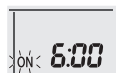

- "6:00" is displayed on the LCD.
- "ON" blinks.

- "⊕" and day of the week are no longer displayed on the LCD.

2. Press **SELECT** until the time setting reaches the point you like.

- Each pressing of either button increases or decreases the time setting by 10 minutes. Holding down either button changes the setting rapidly.

3. Press **ON** again.

- "ON" and setting time are displayed on the LCD.
- The TIMER lamp lights orange.



Display

■ To cancel ON TIMER operation

Press **CANCEL**.

- "ON" and setting time are no longer displayed on the LCD.
- "⊕" and day of the week are displayed on the LCD.
- The TIMER lamp goes off.

■ To combine ON TIMER and OFF TIMER

- A sample setting for combining the 2 timers is shown below.

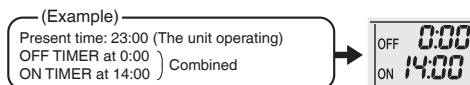

NOTE

- In the following cases, set the timer again.
 - After a circuit breaker has turned off.
 - After a power failure.
 - After replacing batteries in the remote controller.



WEEKLY TIMER Operation

Up to 4 timer settings can be saved for each day of the week. It is convenient if the WEEKLY TIMER is set according to the family's lifestyle.

■ Using in these cases of WEEKLY TIMER

Example: The same timer settings are made for the week from Monday through Friday while different timer settings are made for the weekend.

<p>[Monday]</p>	<p>Make timer settings up to programs 1-4. ▶Page 23</p> <p>Program 1 Program 2 Program 3 Program 4</p> <p>ON OFF ON OFF</p> <p>77°F (25°C) 81°F (27°C)</p> <p>6:00 8:30 17:30 22:00</p>
<p>[Tuesday] to [Friday]</p>	<p>Use the copy mode to make settings for Tuesday to Friday, because these settings are the same as those for Monday. ▶Page 25</p> <p>Program 1 Program 2 Program 3 Program 4</p> <p>ON OFF ON OFF</p> <p>77°F (25°C) 81°F (27°C)</p> <p>6:00 8:30 17:30 22:00</p>
<p>[Saturday]</p>	<p>No timer settings</p>
<p>[Sunday]</p>	<p>Make timer settings up to programs 1-4. ▶Page 23</p> <p>Program 1 Program 2 Program 3 Program 4</p> <p>ON OFF OFF ON</p> <p>77°F (25°C) 81°F (27°C) 81°F (27°C)</p> <p>8:00 10:00 19:00 21:00</p>

- Up to 4 reservations per day and 28 reservations per week can be set in the WEEKLY TIMER. The effective use of the copy mode ensures ease of making reservations.
- The use of ON-ON-ON-ON settings, for example, makes it possible to schedule operating mode and set temperature changes. Furthermore, by using OFF-OFF-OFF-OFF settings, only the turn off time of each day can be set. This will turn off the air conditioner automatically if the user forgets to turn it off.



WEEKLY TIMER Operation

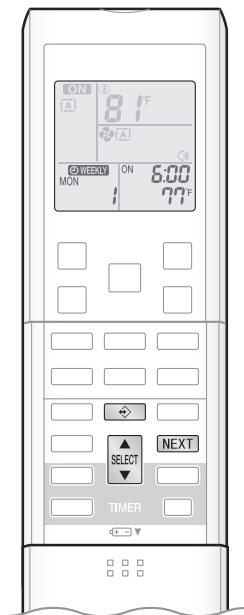

■ To use WEEKLY TIMER operation

Setting mode

- Make sure the day of the week and time are set. If not, set the day of the week and time. ▶Page 10

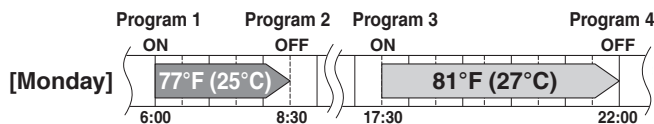

Setting Displays

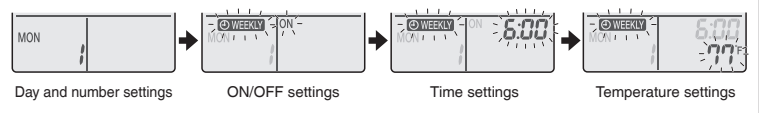

1. Press .

- The day of the week and the reservation number of the current day will be displayed.
- 1 to 4 settings can be made per day.

2. Press to select the desired day of the week and reservation number.

- Pressing changes the reservation number and the day of the week.

3. Press .

- The day of the week and reservation number will be set.
- “ WEEKLY” and “ON” blink.

4. Press to select the desired mode.

- Pressing changes “ON” or “OFF” setting in sequence.



- In case the reservation has already been set, selecting “blank” deletes the reservation.
- Go to **STEP 9** if “blank” is selected.

5. Press .

- The ON/OFF TIMER mode will be set.
- “ WEEKLY” and the time blink.

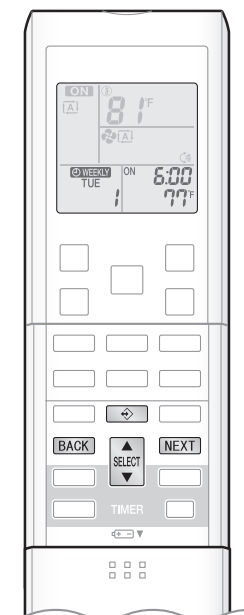

6. Press to select the desired time.

- The time can be set between 0:00 and 23:50 in 10 minute intervals.
- To return to the ON/OFF TIMER mode setting, press **BACK**.
- Go to **STEP 9** when setting the OFF TIMER.

7. Press .

- The time will be set.
- “ WEEKLY” and the temperature blink.

8. Press to select the desired temperature.

- The temperature can be set between 50°F (10°C) and 90°F (32°C).
Cooling: The unit operates at 64°F (18°C) even if it is set at 50°F (10°C) to 63°F (17°C).
Heating: The unit operates at 86°F (30°C) even if it is set at 87°F (31°C) to 90°F (32°C).
- To return to the time setting, press **BACK**.
- The set temperature is only displayed when the mode setting is on.

9. Press .

- The temperature will be set and go to the next reservation setting.
- To continue further settings, repeat the procedure from **STEP 4**.

10. Press to complete the setting.

- Be sure to direct the remote controller toward the indoor unit and check for a receiving tone and flashing the OPERATION lamp.
- “ WEEKLY” is displayed on the LCD and WEEKLY TIMER operation is activated.
- The TIMER lamp lights orange.







Display

- A reservation made once can be easily copied and the same settings used for another day of the week. Refer to **Copy mode** . 

NOTE

■ Notes on WEEKLY TIMER operation

- Do not forget to set the clock on the remote controller first. 
- The day of the week, ON/OFF TIMER mode, time and set temperature (only for ON TIMER mode) can be set with WEEKLY TIMER. Other settings for ON TIMER are based on the settings just before the operation.
- Both WEEKLY TIMER and ON/OFF TIMER operation cannot be used at the same time. The ON/OFF TIMER operation has priority if it is set while WEEKLY TIMER is still active. The WEEKLY TIMER will go into standby state, and “ WEEKLY” will be no longer displayed on the LCD. When ON/OFF TIMER is up, the WEEKLY TIMER will automatically become active.
- Only the time and set temperature with the WEEKLY TIMER are sent with the . Set the WEEKLY TIMER only after setting the operation mode, the airflow rate and the airflow direction ahead of time.
- Shutting the circuit breaker off, power failure, and other similar events will render operation of the indoor unit's internal clock inaccurate. Reset the clock. 
- The **BACK** can be used only for the time and temperature settings. It cannot be used to go back to the reservation number.



WEEKLY TIMER Operation

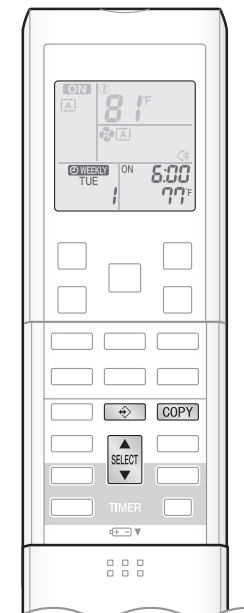

Copy mode

- A reservation made once can be copied to another day of the week. The whole reservation of the selected day of the week will be copied.

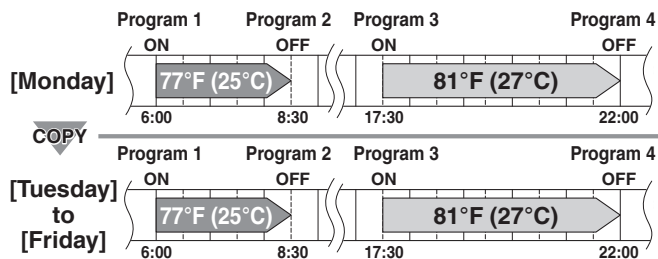

Setting Displays

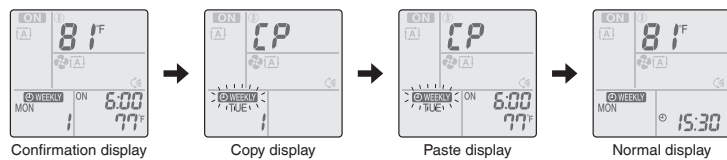

- Press .
- Press to confirm the day of the week to be copied.
- Press **COPY**.
 - The whole reservation of the selected day of the week will be copied.
- Press to select the destination day of the week.
- Press **COPY**.
 - The reservation will be copied to the selected day of the week. The whole reservation of the selected day of the week will be copied.
 - To continue copying the settings to other days of the week, repeat **STEP 4** and **STEP 5**.
- Press to complete the setting.
 - " WEEKLY" is displayed on the LCD and WEEKLY TIMER operation is activated.

NOTE

■ Note on COPY MODE

- The entire reservation of the source day of the week is copied in the copy mode.
- In the case of making a reservation change for any day of the week individually after copying the content of weekly reservations, press

and change the settings in the steps of **Setting mode**. ▶ [Page 23](#)

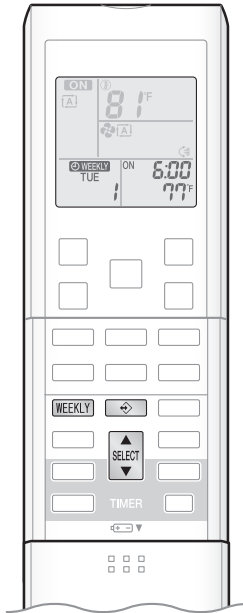

■ Confirming a reservation

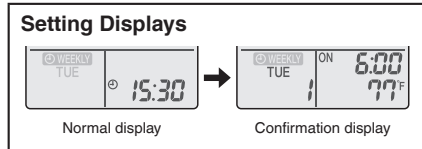

- The reservation can be confirmed.



1. Press .

- The day of the week and the reservation number of current day will be displayed.

2. Press **SELECT** to select the day of the week and the reservation number to be confirmed.

- Pressing  **SELECT**  displays the reservation details.
- To change the confirmed reserved settings, select the reservation number and press **NEXT**.

The mode is switched to setting mode. Go to **Setting mode STEP 4**.  **Page 23**

3. Press to exit confirming mode.

- “ WEEKLY” is displayed on the LCD and WEEKLY TIMER operation is activated.
- The TIMER lamp lights orange.



Display

■ To deactivate WEEKLY TIMER operation

Press **WEEKLY** while “ WEEKLY” is displayed on the LCD.

- “ WEEKLY” will be no longer displayed on the LCD.
- The TIMER lamp goes off.
- To reactivate the WEEKLY TIMER operation, press **WEEKLY** again.
- If a reservation deactivated with **WEEKLY** is activated once again, the last reservation mode will be used.



WEEKLY TIMER Operation

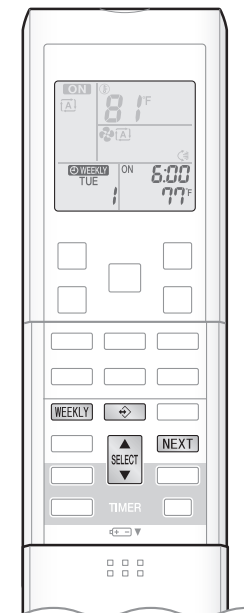

■ To delete reservations

The individual reservation

1. Press .
 - The day of the week and the reservation number will be displayed.
2. Press **SELECT** to select the day of the week and the reservation number to be deleted.
3. Press **NEXT**.
 - "WEEKLY" and "ON" or "OFF" blink.
4. Press **SELECT** and select "blank".

• Pressing **SELECT** changes ON/OFF TIMER mode.

• The reservation will be no setting with selecting "blank".



5. Press **NEXT**.
 - The selected reservation will be deleted.
6. Press .
 - If there are still other reservations, WEEKLY TIMER operation will be activated.

The reservations for each day of the week

- This function can be used for deleting reservations for each day of the week.
- It can be used while confirming or setting reservations.

1. Press .
 - The day of the week and the reservation number will be displayed.
2. Press **SELECT** to select the day of the week to be deleted.
3. Hold **WEEKLY** for 5 seconds.
 - The reservation of the selected day of the week will be deleted.
4. Press .
 - If there are still other reservations, WEEKLY TIMER operation will be activated.

All reservations

Hold **WEEKLY** for 5 seconds while normal display.

- Be sure to direct the remote controller toward the indoor unit and check for a receiving tone.
- This operation is not effective on the setting display of WEEKLY TIMER.
- All reservations will be deleted.

Note for Multi System

Multi system has one outdoor unit connected to multiple indoor units.

■ Selecting the operation mode

With the priority room setting present but inactive or not present.

When more than one indoor unit is operating, priority is given to the first unit that was turned on.

In this case, set the units that are turned on later to the same operation mode as the first unit.

Otherwise, they will enter the standby state, and the OPERATION lamp will flash: this does not indicate malfunction.

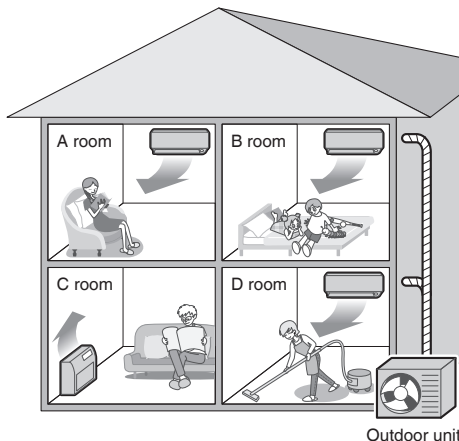

NOTE

■ Notes on operation mode for multi system

- COOL, DRY and FAN operation may be used at the same time.
- AUTO operation automatically selects COOL operation or HEAT operation based on the room temperature. Therefore, AUTO operation is available when selecting the same operation mode as that of the room with the first unit to be turned on.

⚠ CAUTION

- Normally, the operation mode in the room where the unit is first run is given priority, but the following situations are exceptions, so please keep this in mind.

If the operation mode of the first room is **FAN operation**, then using **HEAT operation** in any room after this will give priority to **HEAT operation**. In this situation, the air conditioner running in FAN operation will go on standby, and the OPERATION lamp will flash.

With the priority room setting active.

Refer to "Priority room setting" on the next page.

■ NIGHT QUIET mode (Available only for COOL operation)

NIGHT QUIET mode requires initial programming during installation. Please consult your retailer or dealer for assistance. NIGHT QUIET mode reduces the operation noise of the outdoor unit during the nighttime hours to prevent annoyance to neighbors.

- The NIGHT QUIET mode is activated when the temperature drops 10.8°F (6°C) or more below the highest temperature recorded that day. Therefore, when the temperature difference is less than 7.2°F (4°C), this function will not be activated.
- NIGHT QUIET mode reduces slightly the cooling efficiency of the unit.

■ QUIET OUTDOOR UNIT operation

Refer to "QUIET OUTDOOR UNIT operation". ▶Page 18

With the priority room setting present but inactive or not present.

When using the QUIET OUTDOOR UNIT operation feature with the Multi system, set all indoor units to QUIET OUTDOOR UNIT operation using their remote controllers.

When clearing QUIET OUTDOOR UNIT operation, clear one of the operating indoor units using their remote controller.

However QUIET OUTDOOR UNIT operation display remains on the remote controller for other rooms.

We recommend you release all rooms using their remote controllers.

With the priority room setting active.

Refer to "Priority room setting" on the next page.

Note for Multi System

■ COOL / HEAT mode lock

The COOL / HEAT mode lock requires initial programming during installation. Please consult your authorized dealer for assistance. The COOL / HEAT mode lock sets the unit forcibly to either COOL or HEAT operation. This function is convenient when you wish to set all indoor units connected to the multi system to the same operation mode.

■ Priority room setting

The priority room setting requires initial programming during installation. Please consult your authorized dealer for assistance. The room designated as the priority room takes priority in the following situations.

Operation mode priority

- As the operation mode of the priority room takes precedence, the user can select a different operation mode from other rooms.

[Example]

- Room A is the priority room in the examples.
When COOL operation is selected in room A while operating the following modes in room B, C and D:

Operation mode in room B, C and D	Status of room B, C and D when the unit in room A is in COOL operation
COOL or DRY or FAN	Current operation mode maintained
HEAT	The unit enters standby mode. Operation resumes when the room A unit stops operating.
AUTO	If the unit is set to COOL operation, it continues. If the unit is set to HEAT operation, it enters standby mode. Operation resumes when the room A unit stops operating.

Priority when POWERFUL operation is used

[Example]

- Room A is the priority room in the examples.
The indoor units in rooms A, B, C and D are all operating. If the unit in room A enters POWERFUL operation, operation capacity will be concentrated in room A. In such a case, the cooling (heating) efficiency of the units in room B, C and D may be slightly reduced.

Priority when using QUIET OUTDOOR UNIT operation

[Example]

- Room A is the priority room in the examples.
Just by setting the unit in room A to QUIET operation, the air conditioner starts QUIET OUTDOOR UNIT operation. You don't have to set all the operated indoor units to QUIET operation.

Care and Cleaning

■ Quick reference

How to open / close the front panel

- Hold the front panel by the panel tabs on the both sides and open it.
- Press the front panel at both sides and the center to close it.

Cleaning parts

Front panel

- Wipe it with a soft damp cloth.

If dirty

Refer to ▶ Page 31

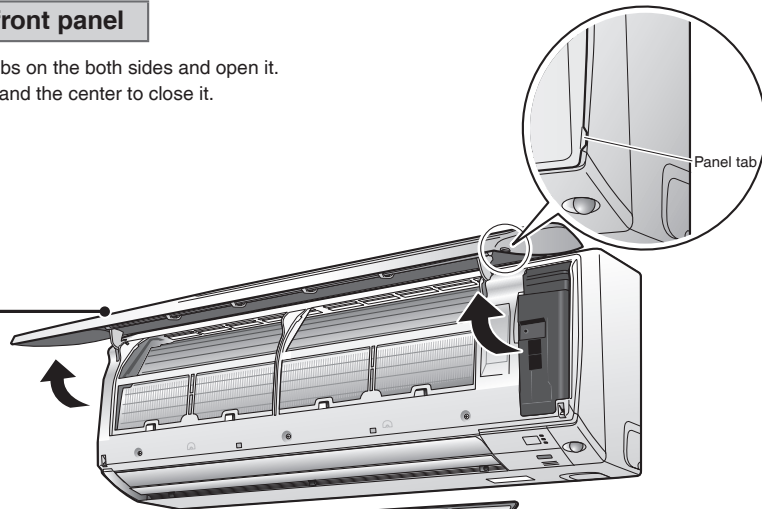

Air filter

- Vacuum dust or wash the filter.

Once every 2 weeks

Refer to ▶ Page 32

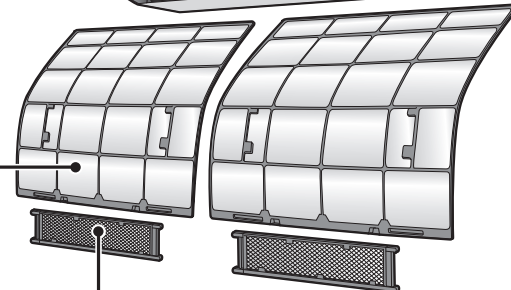

Titanium apatite deodorizing filter

- Vacuum dust or replace the filter.

[Cleaning]
Once every 6 months
Refer to ▶ Page 33

[Replacement]
Once every 3 years
Refer to ▶ Page 33

Indoor unit, Outdoor unit and Remote controller

- Wipe them with a soft cloth.

If dirty

Notes on cleaning

■ For cleaning, do not use the materials as follows.

- Hot water above 104°F (40°C).
- Benzine, gasoline, thinner, other volatile oils.
- Polishing compound.
- Rough materials such as a scrubbing brush.
- Sprays such as deodorizers.



⚠ CAUTION

- Before cleaning, be sure to stop the operation and turn the circuit breaker off.
- Do not touch the aluminum fins of the indoor unit. If you touch those parts, this may cause an injury.

Care and Cleaning

■ Front panel

1. Remove the front panel.

- Open the front panel.
- Slide the front panel to either the left or right and pull it toward you. This will disconnect the front panel shaft on one side.

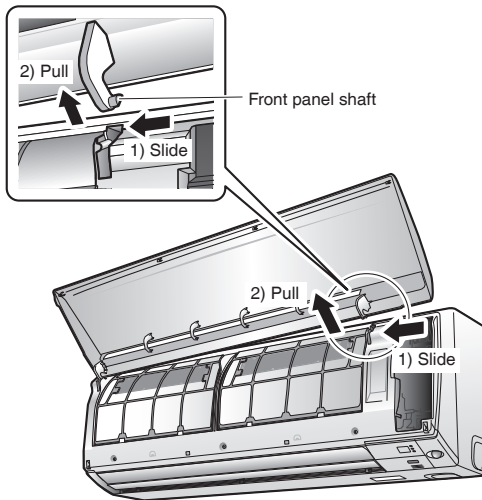

- Disconnect the front panel shaft on the other side in the same manner.

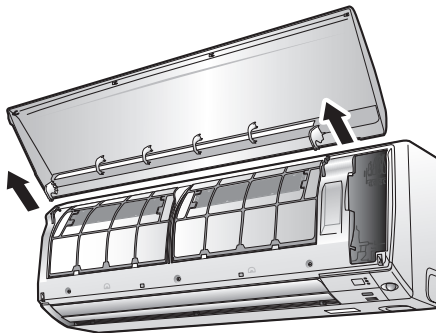

2. Clean the front panel.

- Wipe it with a soft damp cloth.
- Only neutral detergent may be used.
- In case of washing the panel with water, wipe it with a dry soft cloth, and let it dry in the shade after washing.

3. Attach the front panel.

- Align the front panel shaft on the left and right of the front panel with the slots, then push them all the way in.

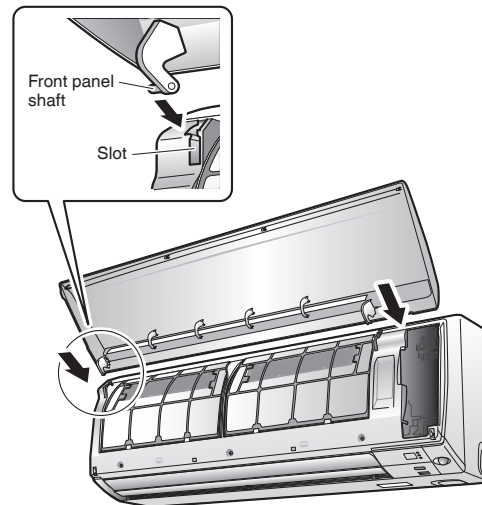

- Close the front panel slowly. (Press the panel at both sides and the central area.)

⚠ CAUTION

- When removing or attaching the front panel, stand on a solid, stable base and take care not to fall.
- When removing or attaching the front panel, support the panel securely with hand to prevent it from falling.
- After cleaning, make sure that the front panel is securely fixed.

■ Air filter

1. Pull out the air filters.

- Open the front panel.
- Push the filter tab at the center of each air filter slightly upward, then pull it down.

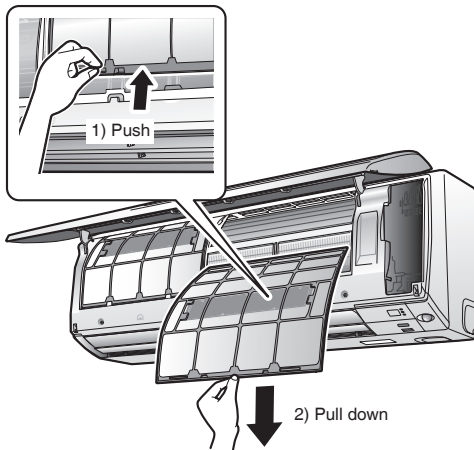

2. Wash the air filters with water or clean them with vacuum cleaner.

- It is recommended to clean the air filters every 2 weeks.

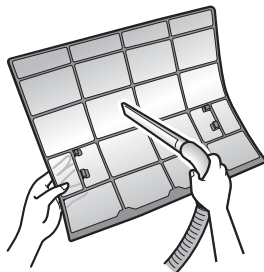

If the dust does not come off easily

- Wash the air filters with neutral detergent thinned with lukewarm water, then let them dry in the shade.
- Be sure to remove the titanium apatite deodorizing filter. Refer to "Titanium apatite deodorizing filter" on the next page.

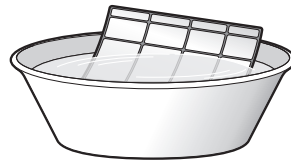

3. Set the filters as they were and close the front panel.

- Press the front panel at both sides and the central area.

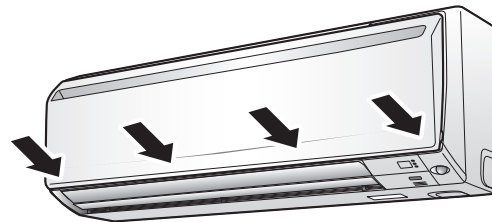

⚠ CAUTION

- Do not touch the aluminum fins by bare hand at the time of dismantling or mounting the filter.

Care and Cleaning

■ Titanium apatite deodorizing filter

1. Take off the titanium apatite deodorizing filter.

- Open the front panel and pull out the air filters.
- Hold the recessed parts of the frame and unhook the 4 claws.

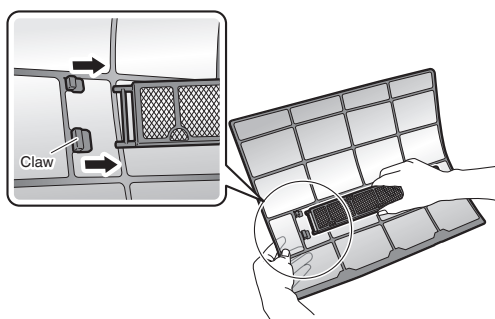

2. Clean or replace the titanium apatite deodorizing filter.

[Maintenance]

2-1 Vacuum dust, and soak in lukewarm water or water for about 10 to 15 minutes if dirt is heavy.

- Do not remove the filter from frame when washing with water.



2-2 After washing, shake off remaining water and dry in the shade.

- Since the material is made out of polyester, do not wring out the filter when removing water from it.

[Replacement]

Remove the tabs on the filter frame and replace with a new filter.

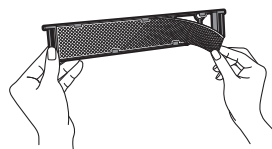

- Do not throw away the filter frame. Reuse the filter frame when replacing the titanium apatite deodorizing filter.
- Dispose of the old filter as non-flammable waste.

3. Set the filters as they were and close the front panel.

- Press the front panel at both sides and the central area.

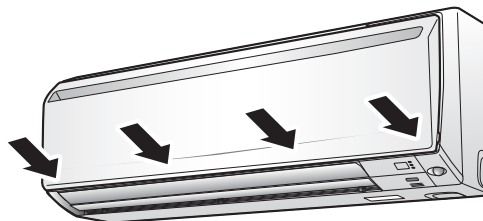

NOTE

- Operation with dirty filters:
 - cannot deodorize the air,
 - cannot clean the air,
 - results in poor heating or cooling,
 - may cause odor.
- Dispose of old filters as non-flammable waste.
- To order a titanium apatite deodorizing filter, contact the dealer where you bought the air conditioner.

Item	Titanium apatite deodorizing filter (without frame) 1 set
Part No.	KAF970A46

■ Check the units

- Check that the base, stand and other fittings of the outdoor unit are not decayed or corroded.
 - Check that nothing blocks the air inlets and the outlets of the indoor unit and the outdoor unit.
 - Check that the drain comes smoothly out of the drain hose during COOL or DRY operation.
 - If no drain water is seen, water may be leaking from the indoor unit. Stop operation and consult your dealer if this is the case.
-

■ Before a long idle period

1. Operate the FAN only for several hours on a nice day to dry out the inside.

- Press **MODE** and select "🌀" operation.
- Press **ON/OFF** and start the operation.

2. After operation stops, turn off the circuit breaker for the room air conditioner.

3. Clean the air filters and set them again.

4. Take out batteries from the remote controller.

- When a multi outdoor unit is connected, make sure the HEAT operation is not being used in other rooms before you use the FAN operation. ▶Page 28

■ We recommend periodical maintenance

- In certain operating conditions, the inside of the air conditioner may get foul after several seasons of use, resulting in poor performance. It is recommended to have periodical maintenance by a qualified contractor in addition to regular cleaning by the user.
- For qualified contractor maintenance, please contact the dealer where you bought the air conditioner.

FAQ

Indoor unit

The flaps do not start swinging immediately.

- The air conditioner is adjusting the position of the flaps. The flaps will start moving soon.

The air conditioner stops generating airflow during HEAT operation.

- Once the set temperature is reached, the airflow rate is reduced and operation stopped in order to avoid generating a cool airflow. Operation will resume automatically when the indoor temperature falls.

HEAT operation stops suddenly and a flowing sound is heard.

- The outdoor unit is defrosting. HEAT operation starts after the frost on the outdoor unit has been removed. This can take about 4 to 12 minutes.

Operation does not start soon.

- **When the unit is turned on again soon after being turned off.**
- **When the mode was reselected.**
 - This is to protect the air conditioner. You should wait for about 3 minutes.

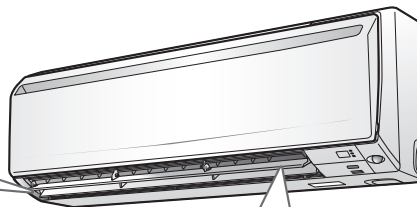

Different sounds are heard.

- **A sound like flowing water**
 - This sound is generated because the refrigerant in the air conditioner is flowing.
 - This is a pumping sound of the water in the air conditioner and can be heard when the water is pumped out from the air conditioner during COOL or DRY operation.
 - The refrigerant flows in the air conditioner even if the air conditioner is not working when the indoor units in other rooms are in operation.
- **Blowing sound**
 - This sound is generated when the flow of the refrigerant in the air conditioner is switched over.
- **Ticking sound**
 - This sound is generated when the cabinet and frame of the air conditioner slightly expand or shrink as a result of temperature changes.
- **Whistling sound**
 - This sound is generated when refrigerant flows during defrosting operation.
- **Clicking sound during operation or idle time**
 - This sound is generated when the refrigerant control valves or the electrical parts operate.
- **Clopping sound**
 - This sound is heard from the inside of the air conditioner when the exhaust fan is activated while the room doors are closed. Open the window or turn off the exhaust fan.

Outdoor unit

Operating sound is loud.

- When frost forms on the heat exchanger of the outdoor unit, the operating sound level increases slightly.

The outdoor unit emits water or steam.

- **In HEAT operation**
 - The frost on the outdoor unit melts into water or steam when the air conditioner is in defrosting operation.
- **In COOL or DRY operation**
 - Moisture in the air condenses into water on the cool surface of the outdoor unit piping and drips.

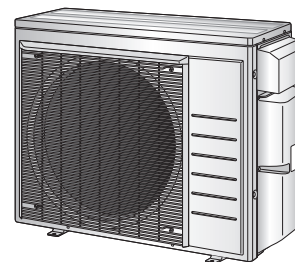

Troubleshooting

Before making an inquiry or a request for repair, please check the following.
If the problem persists, consult your dealer.



Not a problem

This case is not a problem.



Check

Please check again before requesting repairs.

The air conditioner does not operate

Case	Description / what to check
OPERATION lamp is off.	<ul style="list-style-type: none"> Has the circuit breaker been tripped or the fuse blown? Is there a power failure? Are batteries set in the remote controller? Is the timer setting correct?
OPERATION lamp is blinking.	<ul style="list-style-type: none"> Check the error code and consult your dealer. ▶ Page 39

The air conditioner suddenly stops operating

Case	Description / what to check
OPERATION lamp is on.	<ul style="list-style-type: none"> To protect the system, the air conditioner may stop operating after sudden large voltage fluctuations. It automatically resumes operation in about 3 minutes.
OPERATION lamp is blinking.	<ul style="list-style-type: none"> Is there anything blocking the air inlet or air outlet of the indoor unit or outdoor unit? Stop operation and after turning off the circuit breaker, remove the obstruction. Then restart operation with the remote controller. If the OPERATION lamp is still blinking, check the error code and consult your dealer. ▶ Page 39 Are operation modes all the same for indoor units connected to outdoor units in the multi system? If not, set all indoor units to the same operation mode and confirm that the lamps blink. When the operation mode is in "AUTO", set all indoor unit operation modes to "COOL" or "HEAT" for a moment and check again that the lamps are normal. If the lamps stop blinking after the above steps, there is no malfunction. ▶ Page 28

The air conditioner does not stop operating

Case	Description / what to check
The air conditioner continues operating even after operation is stopped.	<ul style="list-style-type: none"> <ul style="list-style-type: none"> Immediately after the air conditioner is stopped <ul style="list-style-type: none"> The outdoor unit fan continues rotating for about another 1 minute to protect the system. While the air conditioner is not in operation <ul style="list-style-type: none"> When the outdoor temperature is high, the outdoor unit fan may start rotating to protect the system.

The room does not cool down / warm up

Case	Description / what to check
Air does not come out.	<ul style="list-style-type: none"> <ul style="list-style-type: none"> In HEAT operation <ul style="list-style-type: none"> The air conditioner is warming up. Wait for about 1 to 4 minutes. During defrosting operation, hot air does not flow out of the indoor unit. When the air conditioner operates immediately after the circuit breaker is turned on <ul style="list-style-type: none"> The air conditioner is preparing to operate. Wait for about 3 to 20 minutes.
Air does not come out / Air comes out.	<ul style="list-style-type: none"> Is the airflow rate setting appropriate? <ul style="list-style-type: none"> Is the airflow rate setting low, such as "Indoor unit quiet" or "Airflow rate 1"? Increase the airflow rate setting. Is the set temperature appropriate? Is the adjustment of the airflow direction appropriate?
Air comes out.	<ul style="list-style-type: none"> Is there any furniture directly under or beside the indoor unit? Is the air conditioner in ECONO operation? ▶ Page 19 Are the air filters dirty? Is there anything blocking the air inlet or air outlet of the indoor unit or outdoor unit? Is a window or door open? Is an exhaust fan turning?

Water or mist comes out

Case	Description / what to check
Mist comes out of the indoor unit.	<ul style="list-style-type: none"> This happens when the air in the room is cooled into mist by the cold airflow during COOL or other operation. This is because the air in the room is cooled by the heat exchanger and becomes mist during defrosting operation.
Water is leaking from the indoor unit.	<ul style="list-style-type: none"> If the drain hose is crushed or clogged, water from the indoor unit may be unable to drain and start leaking. Stop operation of the unit immediately and contact your dealer.

Troubleshooting

Remote controller

Case	Description / what to check
The unit does not receive signals from the remote controller or has a limited operating range.	<ul style="list-style-type: none"> ✓ The batteries may be exhausted. Replace both batteries with new dry batteries AAA.LR03 (alkaline). For details, refer to "Preparation Before Operation". ▶ Page 9 Signal communication may be disabled if an electronic-starter-type fluorescent lamp (such as inverter-type lamps) is in the room. Consult your dealer if that is the case. The remote controller may not function correctly if the transmitter is exposed to direct sunlight. Is there a device in the room that redirects remote controller signals? Some appliances such as TV speakers are equipped with these devices. If there is such a device in the room, the signals it emits may interfere with signals from the remote controller, preventing reception. Infrared rays from smartphones and game consoles may interfere with signals from the remote controller, preventing reception.
LCD is faint, is not working, or the display is erratic.	<ul style="list-style-type: none"> ✓ The batteries may be exhausted. Replace both batteries with new dry batteries AAA.LR03 (alkaline). For details, refer to "Preparation Before Operation". ▶ Page 9
Other electric devices start operating.	<ul style="list-style-type: none"> ✓ If the remote controller activates other electric devices, move them away or consult your dealer.

Air has an odor

Case	Description / what to check
The air conditioner gives off an odor.	<ul style="list-style-type: none"> ✓ The room odor absorbed in the unit is discharged with the airflow. We recommend you to have the indoor unit cleaned. Please consult your dealer.
	<ul style="list-style-type: none"> ✓ The indoor unit is blowing out room odor it has absorbed (the smell of walls or carpeting, furniture, clothes, and so on). If the air conditioner has been used for a long time, there is a chance that a dirty heat exchanger or fan are emitting an odor. We recommend you to have the indoor unit cleaned. Please consult the dealer where you bought the air conditioner. Do not spray the air conditioner unit with any deodorizers.

Others

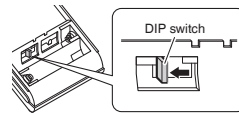
Case	Description / what to check
The air conditioner suddenly starts behaving strangely during operation.	<ul style="list-style-type: none"> ? The air conditioner may malfunction due to lightning or radio. If the air conditioner malfunctions, turn off the power with the circuit breaker and restart the operation with the remote controller.
HEAT operation cannot be selected, even though the unit is heat pump model.	<ul style="list-style-type: none"> ? Slide the DIP switch to the left as shown in the illustration so that the HEAT operation can be selected with the "MODE" button. 
The ON/OFF TIMER does not operate according to the settings.	<ul style="list-style-type: none"> ✓ Check if the ON/OFF TIMER and the WEEKLY TIMER are set to the same time. Change or deactivate the settings in the WEEKLY TIMER. ▶ Page 22

Notes on the operating conditions

- If operation continues under any conditions other than those listed in the table,
 - A safety device may activate to stop the operation. (With a multi connection in COOL operation, the safety device may work to stop the operation of the outdoor unit only.)
 - Dew may form on the indoor unit and drip from it when COOL or DRY operation is selected.
- *1 Installing a drain pan heater (sold separately) will further extend the heating operation range to -13°F (-25.0°C). Please consult your dealer.

Mode	Operating conditions
COOL / DRY	Outdoor temperature: [MXS, MXL, MXLH models] : 14 - 115°F (-10 - 46°C)
	Indoor temperature : 64 - 90°F (18 - 32°C)
	Indoor humidity : 80% max.
HEAT	Outdoor temperature: [MXS models] : 5 - 75°F (-15 - 24°C)
	[MXL models] : 5*1 - 75°F (-15*1 - 24°C)
	[MXLH models] : -13 - 75°F (-25 - 24°C)
	*1 -13°F (-25°C) If a drain pan heater (sold separately) is installed.
	Indoor temperature : 50 - 86°F (10 - 30°C)

■ Call your dealer immediately

WARNING

When an abnormality (such as a burning smell) occurs, stop operation and turn off the circuit breaker.

- Continued operation in an abnormal condition may result in problems, electric shock or fire.
- Consult the dealer where you bought the air conditioner.

Do not attempt to repair or modify the air conditioner by yourself.

- Incorrect work may result in electric shock or fire.
- Consult the dealer where you bought the air conditioner.

If one of the following symptoms takes place, call your dealer immediately.

- The power cord is abnormally hot or damaged.
- An abnormal sound is heard during operation.
- The circuit breaker cuts off the operation frequently.
- A switch or a button often fails to work properly.
- There is a burning smell.
- Water leaks from the indoor unit.

Turn off the circuit breaker and call your dealer.



■ After a power failure

- The air conditioner automatically resumes operation in about 3 minutes. Please wait for a while.

■ Lightning

- If there is a risk lightning could strike in the neighborhood, stop operation and turn off the circuit breaker to protect the system.

■ Disposal requirements

- Dismantling of the unit, handling of the refrigerant, oil and other parts, should be done in accordance with the relevant local and national regulations.

Troubleshooting

The OPERATION lamp blinks

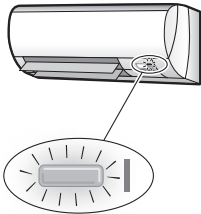

■ Check the interval time between blinks of the OPERATION lamp.

If connecting to multiple indoor units [Blink interval of about 2 to 3 seconds]

Check the operation mode of any indoor units connected in other rooms. Because this is a multi system air conditioner, it has one outdoor unit connected to multiple indoor units in different rooms. If the operation mode is different from the operation mode of the indoor unit in another room, the OPERATION lamp may blink and operation may not be performed, or operation may stop while in progress. COOL, DRY and HEAT operation may not be used at the same time.

[Blink interval of about 0.5 seconds]

This is a notification of an abnormality. Check the error code following the procedure below, and respond according to the instructions in the table.

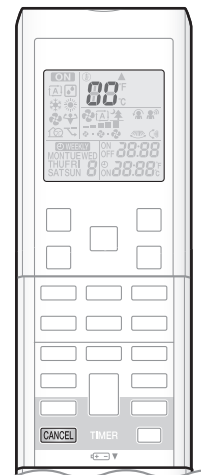

■ Fault diagnosis by remote controller

1. When **CANCEL** is held down for about 5 seconds, “00” blinks in the temperature display section.
2. While pointing the remote controller at the indoor unit, press **CANCEL** repeatedly.
 - A beep indicates a non-corresponding error code
 - A long beep indicates a corresponding error code
3. When a long beep is produced, check the error code and respond according to the instructions in the table.
 - To cancel the code display, hold down **CANCEL** for about 5 seconds (the code display also clears if no button is pressed for a while).

CODE	Cause	Description / what to check
E7	The fan of the outdoor unit is stopped. • Is there any foreign matter inside the outdoor unit?	After turning off the circuit breaker, remove the foreign matter, then turn the power on again and operate.
L3, L4, L5	The temperature inside the outdoor unit has become too high, so operation has stopped. • Is there anything blocking the air outlet of the outdoor unit?	After turning off the circuit breaker, remove the obstruction, then turn the power on again and operate.
Other error codes, or if the error code cannot be checked		An abnormality has occurred.

In the case of error code U0 or F3

	CODE	MEANING
SYSTEM	00	NORMAL
	UA	INDOOR-OUTDOOR UNIT COMBINATION FAULT
	U0	REFRIGERANT SHORTAGE
	U2	DROP VOLTAGE OR MAIN CIRCUIT OVERVOLTAGE
	U4	FAILURE OF TRANSMISSION (BETWEEN INDOOR UNIT AND OUTDOOR UNIT)
INDOOR UNIT	A1	INDOOR PCB DEFECTIVENESS
	A5	HIGH PRESSURE CONTROL OR FREEZE-UP PROTECTOR
	A6	FAN MOTOR FAULT
	C4	FAULTY HEAT EXCHANGER TEMPERATURE SENSOR
	C9	FAULTY SUCTION AIR TEMPERATURE SENSOR
OUTDOOR UNIT	EA	COOLING-HEATING SWITCHING ERROR
	E1	CIRCUIT BOARD FAULT
	E5	OL (COMPRESSOR OVERLOAD) STARTED
	E6	FAULTY COMPRESSOR START UP
	E7	DC FAN MOTOR FAULT
	F3	HIGH TEMPERATURE DISCHARGE PIPE CONTROL
	F6	HIGH PRESSURE CONTROL (IN COOLING)
	H0	SENSOR FAULT
	H6	OPERATION HALT DUE TO FAULTY POSITION DETECTION SENSOR
	H8	DC CURRENT SENSOR FAULT
	H9	FAULTY SUCTION AIR TEMPERATURE SENSOR
	J3	FAULTY DISCHARGE PIPE TEMPERATURE SENSOR
	J6	FAULTY HEAT EXCHANGER TEMPERATURE SENSOR
	L3	ELECTRICAL PARTS HEAT FAULT
	L4	HIGH TEMPERATURE AT INVERTER CIRCUIT HEATSINK
L5	OUTPUT OVERCURRENT	
P4	FAULTY INVERTER CIRCUIT HEATSINK TEMPERATURE SENSOR	

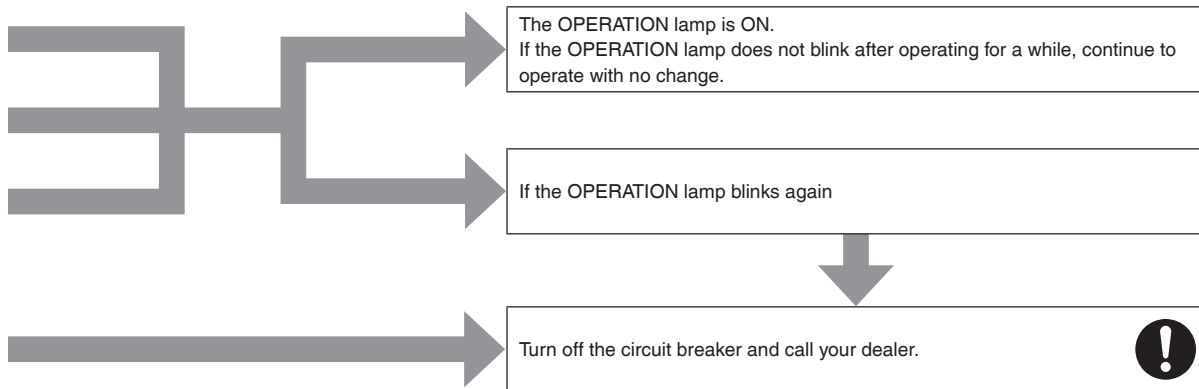

Quick Reference

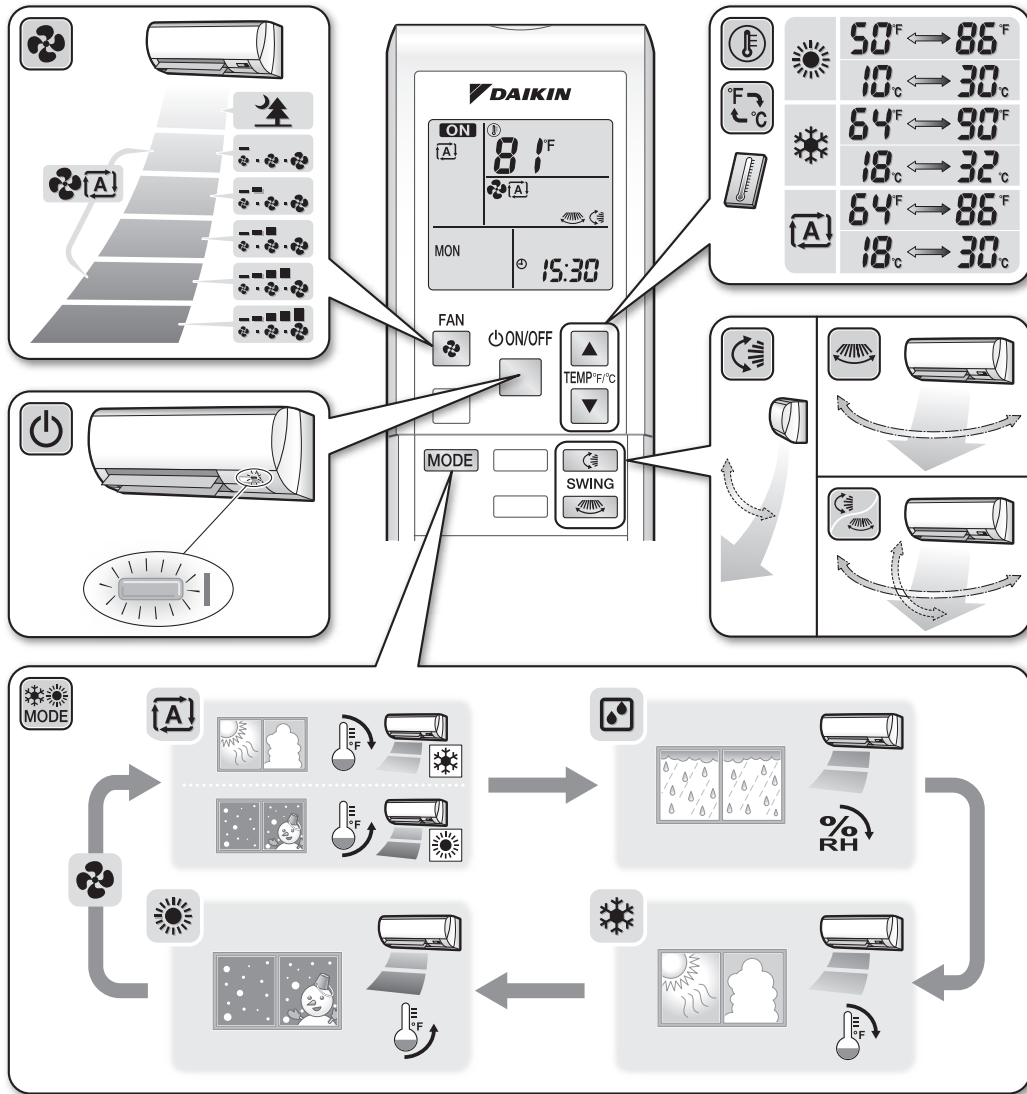

2.2 FTXR

Safety Considerations

Refer also to the General Safety Considerations in the separate booklet.



Read the precautions in this manual carefully before operating the unit.

Read these **Safety Considerations for Operations** carefully before operating an air conditioner or heat pump.

Make sure that the unit operates properly during the startup operation. Instruct the user on how to operate and maintain the unit. Inform users that they should store this operation manual with the installation manual for future reference.

Meanings of **DANGER**, **WARNING**, **CAUTION**, and **NOTE** Symbols:

- DANGER** Indicates an imminently hazardous situation which, if not avoided, will result in death or serious injury.
- WARNING** Indicates a potentially hazardous situation which, if not avoided, could result in death or serious injury.
- CAUTION** Indicates a potentially hazardous situation which, if not avoided, may result in minor or moderate injury. It may also be used to alert against unsafe practices.
- NOTE** Indicates situations that may result in equipment or property damage accidents only.

DANGER

- Do not install the unit in an area where flammable materials are present due to risk of explosion resulting in serious injury or death.
- Any abnormalities in the operation of the air conditioner or heat pump, such as smoke or fire, could result in severe injury or death. Turn off the power and contact your dealer immediately.
- Refrigerant gas may produce toxic gas if it comes into contact with fire, such as from a fan heater, stove, or cooking device. Exposure to this gas could cause severe injury or death.
- For refrigerant leakage, consult your dealer. Refrigerant gas is heavier than air and replaces oxygen. A massive leak could lead to oxygen depletion, especially in basements, and an asphyxiation hazard could occur leading to serious injury or death.
- If equipment utilizing a burner is used in the same room as the air conditioner or heat pump, there is the danger of oxygen deficiency which could lead to an asphyxiation hazard resulting in serious injury or death. Be sure to ventilate the room sufficiently to avoid this hazard.
- Safely dispose of the packing materials. Packing materials, such as nails and other metal or wooden parts, may cause stabs or other injuries.
- Tear apart and throw away plastic packaging bags so that children will not play with them. Children playing with plastic bags face the danger of death by suffocation.

WARNING

- Contact your dealer for repair and maintenance. Improper repair and maintenance may result in water leakage, electric shock, and fire. Only use accessories made by Daikin that are specifically designed for use with the equipment and have them installed by a professional.
- Contact your dealer to move and reinstall the air conditioner or heat pump. Incomplete installation may result in water leakage, electric shock, and fire.
- Never let the indoor unit or the remote controller get wet. Water can cause an electric shock or a fire.
- Never use flammable spray such as hair spray, lacquer, or paint near the unit. Flammable spray may cause a fire.
- When a fuse blows out, never replace it with one of incorrect ampere ratings or different wires. Always replace any blown fuse with a fuse of the same specification.
- Never remove the fan guard of the unit. A fan rotating at high speed without the fan guard is very dangerous.
- Never inspect or service the unit by yourself. Contact a qualified service person to perform this work.
- Turn off all electrical power before doing any maintenance to avoid the risk of serious electric shock; never sprinkle or spill water or liquids on the unit.
- Do not touch the switch with wet fingers. Touching a switch with wet fingers can cause electric shock.
- Do not allow children to play on or around the unit to prevent injury.
- The heat exchanger fins are sharp enough to cut. To avoid injury wear gloves or cover the fins while working around them.
- Do not put a finger or other objects into the air inlet or air outlet. The fan is rotating at high speed and will cause injury.
- Check the unit foundation for damage on a continuous basis, especially if it has been in use for a long time. If left in a damaged condition the unit may fall and cause injury.
- Placing a flower vase or other containers with water or other liquids on the unit could cause a shock or fire if a spill occurs.
- Do not touch the air outlet or horizontal blades while the swing flap is in operation because fingers could get caught and injured.
- Never touch the internal parts of the controller. Do not remove the front panel because some parts inside are dangerous to touch. To check and adjust internal parts, contact your dealer.
- Do not use means to accelerate the defrosting process or to clean, other than those recommended by the manufacturer.
- The appliance must be stored in a room without continuously operating ignition sources (for example: open flames, an operating gas appliance or an operating electric heater).
- Do not pierce or burn.
- Be aware that refrigerants may not contain an odor.

⚠ CAUTION

- Do not use the air conditioner or heat pump for any other purposes other than comfort cooling or heating. Do not use the unit for cooling precision instruments, food, plants, animals or works of art.
- Do not place items under the indoor unit as they may be damaged by condensates that may form if the humidity is above 80% or if the drain outlet gets blocked.
- Before cleaning, stop the operation of the unit by turning the power off or by pulling the supply cord out from its receptacle. Otherwise, an electric shock and injury may result.
- Do not wash the air conditioner or heat pump with excessive water. An electric shock or fire may result.
- Avoid placing the controller in a spot which may be splashed with water. Water entering the controller may cause an electric shock or damage the internal electronic parts.
- Do not operate the air conditioner or heat pump when using a room-fumigation type of insecticide. Failure to observe this could cause the chemicals to be deposited in the unit and can endanger the health of those who are hypersensitive to chemicals.
- Do not turn off the power immediately after stopping operation. Always wait for at least 5 minutes before turning off the power. Otherwise, water leakage may occur.
- The appliance is not intended for use by young children or infirm persons without supervision.
- The remote controller should be kept away from children so they cannot play with it.
- Consult with the installation contractor for cleaning.
- Incorrect cleaning of the inside of the air conditioner or heat pump could make the plastics parts break and cause water leakage or electric shock.
- Do not touch the air inlet or aluminum fin of the air conditioner or heat pump as they can cut and cause injury.
- Do not place objects in direct proximity of the outdoor unit. Do not let leaves and other debris accumulate around the unit. Leaves are a hotbed for small animals which can enter the unit. Once inside the unit, animals can cause the unit to malfunction, and cause smoke or fire when they make contact with electrical parts.
- Do not wipe the controller operation panel with benzene, thinner, chemical dust cloth, etc. The panel may get discolored or the coating can peel off. If it is heavily dirty, soak a cloth in water-diluted neutral detergent, squeeze it well and wipe the panel clean. Then wipe it with another dry cloth.
- Dismantling of the unit, disposal of the refrigerant, oil, and additional parts, should be done in accordance with the relevant local, state, and national regulations.
- Operate the air conditioner or heat pump in a sufficiently ventilated area and not surrounded by obstacles. Do not use the air conditioner or heat pump in the following places.
 - a. Places with a mist of mineral oil, such as cutting oil.
 - b. Locations such as coastal areas where there is a lot of salt in the air.
 - c. Locations such as hot springs where there is a lot of sulfur in the air.
 - d. Locations such as factories where the power voltage varies a lot.
 - e. In cars, boats, and other vehicles.
 - f. Locations such as kitchens where oil may splatter or where there is steam in the air.
 - g. Locations where equipment produces electromagnetic waves.
 - h. Places with an acid or alkaline mist.
 - i. Places where fallen leaves can accumulate or where weeds can grow.
- Take snow protection measures. Contact your dealer for the details of snow protection measures, such as the use of a snow protection hood.
- Do not attempt to do electrical work or grounding work unless you are licensed to do so. Consult with your dealer for electrical work and grounding work.
- Pay attention to operating sound. Be sure to use the following places:
 - a. Places that can sufficiently withstand the weight of the air conditioner or heat pump yet can suppress the operating sound and vibration.
 - b. Places where warm air from the air outlet of the outdoor unit or the operating sound of the outdoor unit does not annoy neighbors.
- Make sure that there are no obstacles close to the outdoor unit. Obstacles close to the outdoor unit may drop the performance of the outdoor unit or increase the operating sound of the outdoor unit.
- Consult your dealer if the air conditioner or heat pump in operation generates unusual noise.
- Make sure that the drainpipe is installed properly to drain water. If no water is discharged from the drainpipe while the air conditioner or heat pump is in the cooling mode, the drainpipe may be clogged with dust or dirt and water leakage from the indoor unit may occur. Stop operating the air conditioner or heat pump and contact your dealer.
- Do not spray the air conditioner unit with any deodorizers, etc. It may cause the unit to malfunction.

⚠ NOTE

- Never press the button of the remote controller with a hard, pointed object. The remote controller may be damaged.
- Never pull or twist the electric wire of the remote controller. It may cause the unit to malfunction.
- Do not place appliances that produce open flames in places that are exposed to the airflow of the unit or under the indoor unit. It may cause incomplete combustion or deformation of the unit due to the heat.
- Do not expose the controller to direct sunlight. The LCD display can become discolored and may fail to display the data.

FTP002M-U

Names of Parts

Indoor Unit

• Appearance of the indoor unit may differ.

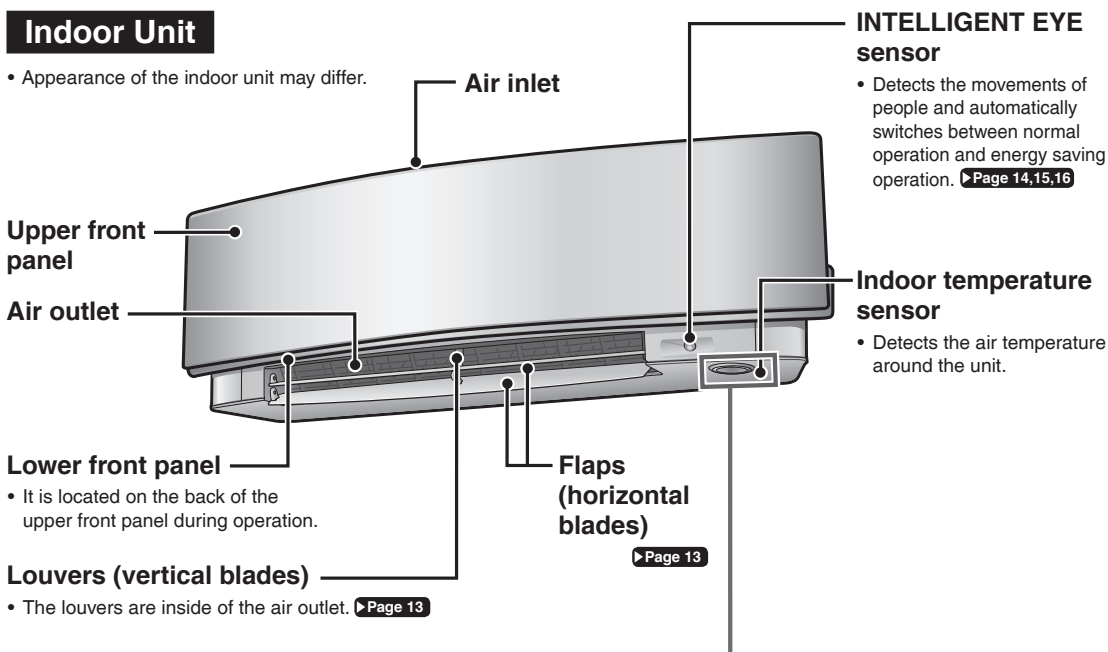

INTELLIGENT EYE sensor

• Detects the movements of people and automatically switches between normal operation and energy saving operation. ▶ Page 14,15,16

Indoor temperature sensor

• Detects the air temperature around the unit.

Upper front panel

Air outlet

Lower front panel

• It is located on the back of the upper front panel during operation.

Louvers (vertical blades)

• The louvers are inside of the air outlet. ▶ Page 13

Air inlet

Flaps (horizontal blades)

▶ Page 13

Display

Multi-monitor lamp and TIMER lamp

Multi-monitor lamp

• The lamp color changes according to the operation.

Operation	Multi-monitor lamp
AUTO	Red/Blue
DRY	Green
COOL	Blue
HEAT	Red
FAN	White
TIMER	Orange

TIMER lamp

• When operation by timer has been set, the multi-monitor lamp periodically changes to orange. After lighting orange for about 5 seconds, it returns to the color of the operation mode. The multi-monitor lamp will turn orange on and off in cyclic manner while the air conditioner is not in operation.

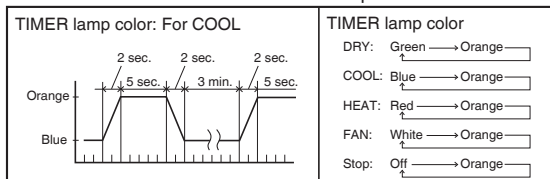

TIMER lamp color	Color transition
DRY: Green	→ Orange
COOL: Blue	→ Orange
HEAT: Red	→ Orange
FAN: White	→ Orange
Stop: Off	→ Orange

INTELLIGENT EYE lamp (green) ▶ Page 15

Signal receiver and Indoor unit ON/OFF switch

Signal receiver

• Receives signals from the remote controller.
• When the unit receives a signal, you will hear a beep sound.

Case	Sound type
Operation start	beep-beep
Setting changed	beep
Operation stop	long beep

Indoor unit ON/OFF switch

• Press this switch once to start operation. Press once again to stop it.
• For the operation mode setting, refer to the following table.
• This switch can be used when the remote controller is missing.

Mode	Temperature setting	Airflow rate
AUTO	77°F (25°C)	AUTO

■ Open the upper front panel

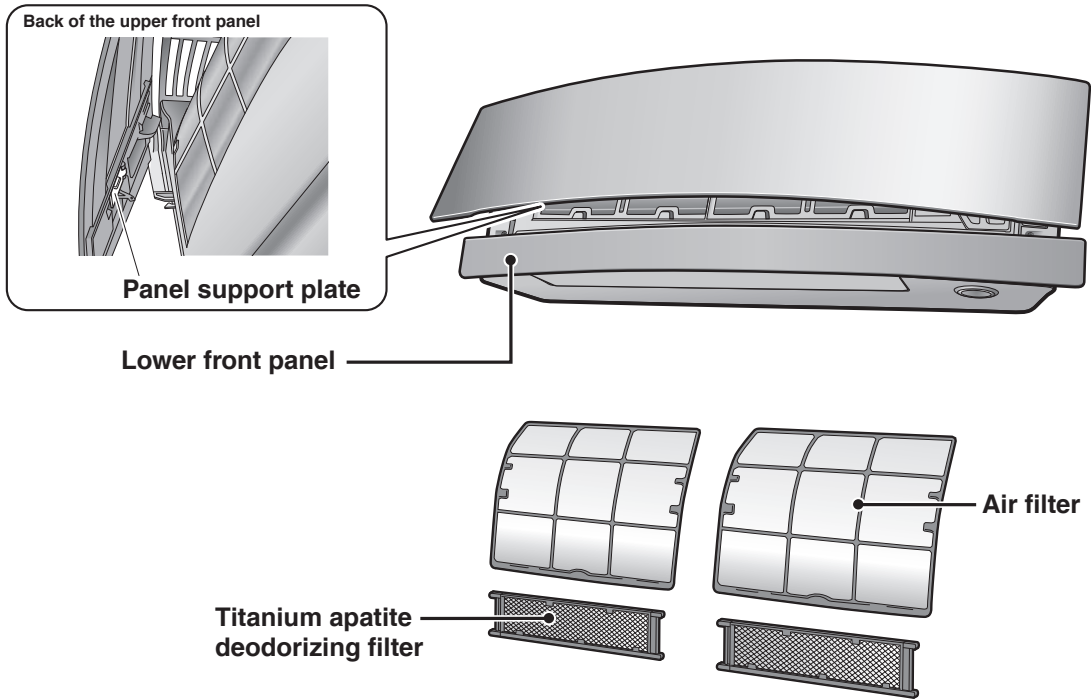

Outdoor Unit

• The appearance of the outdoor unit may differ between different models.

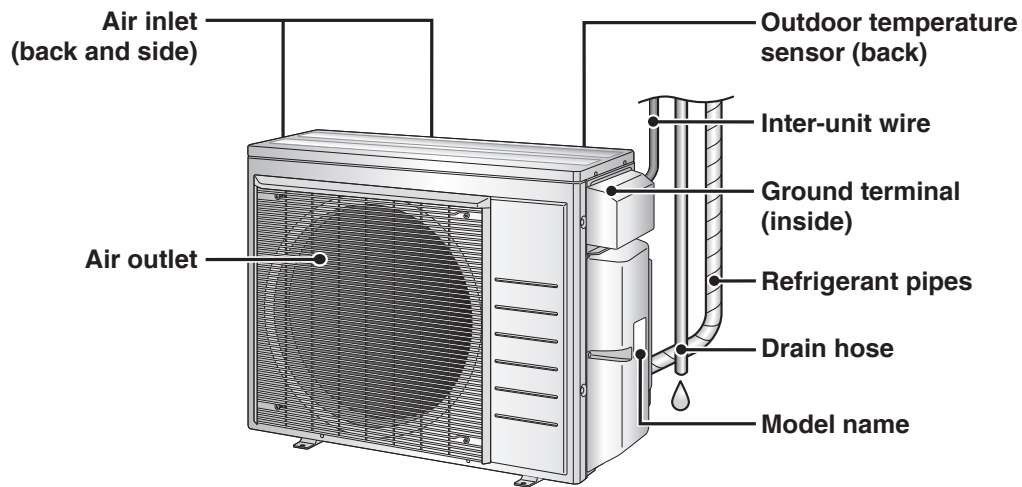

Names of Parts

Remote Controller

Signal transmitter

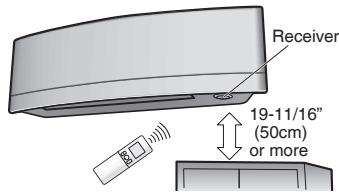

- To use the remote controller, aim the transmitter at the indoor unit. If there is anything blocking the signals between the unit and the remote controller, such as a curtain, the unit may not operate.
- The maximum transmission distance is about 19-11/16ft (6m).
Make sure that there are no obstacles within 19-11/16 inch (50cm) under the signal receiver.
Such obstacles, if any, may have an adverse influence on the reception performance of the receiver and the reception distance may be shortened.

FAN setting button

- Selects the airflow rate setting. [▶ Page 12](#)

POWERFUL button

- POWERFUL operation. [▶ Page 17](#)

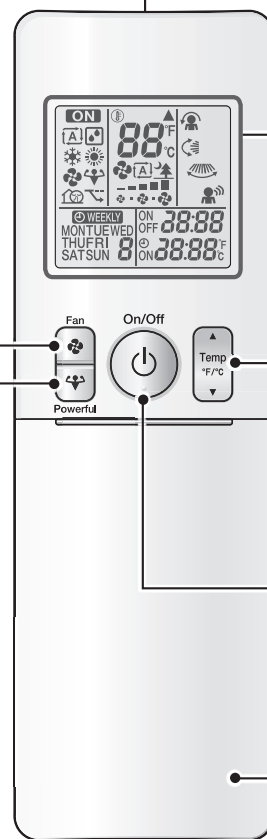

Display (LCD)

- Displays the current settings.
(In this illustration, each section is shown with all its displays on for the purpose of explanation.)

TEMPERATURE adjustment button

- Changes the temperature setting. [▶ Page 11](#)

ON/OFF button

- Press this button once to start operation.
Press once again to stop it. [▶ Page 11](#)

Front cover

- Open the front cover. [▶ Page 8](#)

Model	ARC466A36
-------	-----------

■ Open the front cover

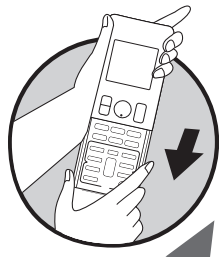

MODE selector button

- Selects the operation mode. (AUTO/DRY/COOL/HEAT/FAN) ▶Page 11

ECONO/QUIET button

- ECONO/QUIET OUTDOOR UNIT operation. ▶Page 18

Lamp brightness setting button

▶Page 10

COMFORT/SENSOR button

- COMFORT AIRFLOW and INTELLIGENT EYE operation. ▶Page 14

OFF TIMER button (NIGHT SET mode)

▶Page 20

TIMER CANCEL button

- Cancels the timer setting. ▶Page 19,20
- Cannot be used for the WEEKLY TIMER operation.

SELECT button

- Changes the clock, ON/OFF TIMER and WEEKLY TIMER settings.

SWING button

- Adjusts the airflow direction. ▶Page 13

Weekly

◀ : WEEKLY button

◊ : PROGRAM button

Copy

▶ : COPY button

Back

◀ : BACK button

Next

▶ : NEXT button

- WEEKLY TIMER operation. ▶Page 21

ON TIMER button

▶Page 19

CLOCK button

▶Page 10

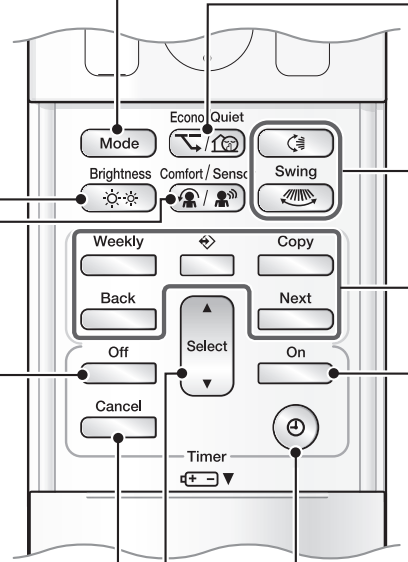

Preparation Before Operation

CAUTION

Incorrect handling of batteries can result in injury from battery leakage, rupturing or heating, or lead to equipment failure. Please observe the following precautions and use safely.

- If the alkaline solution from the batteries should get in the eyes, do not rub the eyes. Instead, immediately flush the eyes with tap water and seek the attention of a medical professional.
- Keep batteries out of reach of children. In the event that batteries are swallowed, seek the immediate attention of a medical professional.
- Do not expose batteries to heat or fire. Do not disassemble or modify batteries. The insulation or gas release vent inside the battery may be damaged, resulting in battery leakage, rupturing, or heating.
- Do not damage or peel off labels on the batteries.

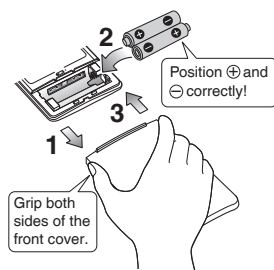

To insert the batteries

1. Slide the front cover to take it off.
2. Insert 2 dry batteries AAA.LR03 (alkaline).
3. Replace the front cover.

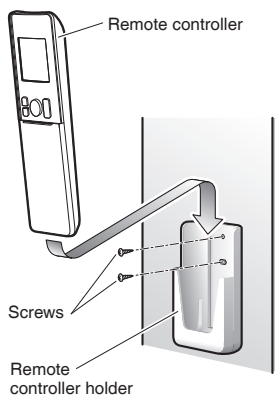

To attach the remote controller holder to a wall

1. Choose a place where the signals reach the unit.
2. Attach the holder to a wall, a pillar, or similar location with the screws supplied with the holder.
3. Place the remote controller in the remote controller holder.

Fahrenheit/Celsius display switch

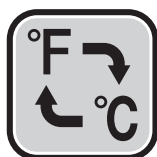

Press  and  (TIMER button) simultaneously for about 5 seconds.

- The temperature will be displayed in Celsius when it is presently displayed in Fahrenheit, and vice versa.
- The switch operation is only possible when the temperature is being displayed.

NOTE

Notes on batteries

- To avoid possible injury or damage from battery leakage or rupturing, remove the batteries when not using the product for long periods of time.
- The standard replacement time is about 1 year. Both batteries should be replaced at the same time. Be sure to replace them with new size AAA.LR03 (alkaline) batteries.
However, if the remote controller display begins to fade and the possible transmission range becomes shorter within a year, replace both batteries as specified above.
- The batteries supplied with the remote controller are for initial operation. The batteries may run out in less than 1 year.

Note on remote controller

- Do not drop the remote controller. Do not get it wet.

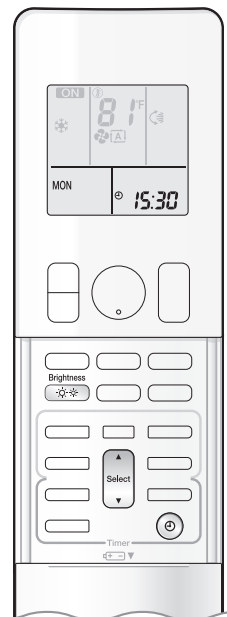

Turn on the circuit breaker

- After the power is turned on, the flaps of the indoor unit open and close once to set the reference position.

To set the luminance of the display

- The luminance of the indoor unit display can be set.



To set the clock

1. Press .



“0:00” is displayed on the LCD.
“MON” and “” blink.

2. Press to set the current day of the week.

3. Press .



“” blinks.

4. Press to set the clock to the present time.

- Holding down or rapidly increases or decreases the displayed time.

5. Press .

- Point the remote controller at the indoor unit when pressing the buttons.



“.” blinks.

NOTE

Fahrenheit/Celsius display change function of remote controller

- The set temperature may increase when the display is changed to Celsius from Fahrenheit, because a fraction of 0.5°C is rounded up.
- Example: A set temperature of 65°F (equivalent to 18.5°C) will be converted into 19°C.
When the display is changed to Fahrenheit again, the set temperature will be converted into 66°F (equivalent to 19°C) instead of the original set temperature (65°F) but a set temperature of 66°F (equivalent to 19°C) will be converted into 19°C with no temperature change.
- A reception sound will go off for the transmission of set temperature to the indoor unit at the time of setting the Fahrenheit/Celsius display change function.

Note on setting the clock

- If the indoor unit's internal clock is not set to the correct time, the ON/OFF TIMER and WEEKLY TIMER will not operate punctually.



AUTO · DRY · COOL · HEAT · FAN Operation

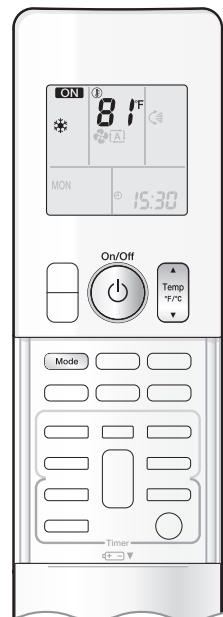

The air conditioner operates with the operation mode of your choice. From the next time on, the air conditioner will operate with the same operation mode.

To start operation

1. Press and select an operation mode.

- Each pressing of the button changes the mode setting in sequence.

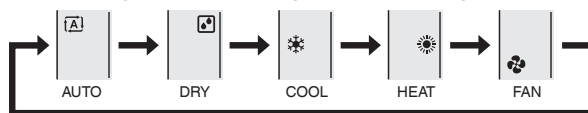

2. Press .

- “**ON**” is displayed on the LCD.
- The multi-monitor lamp lights up. The color of the lamp varies depending on the operation mode.

Operation	Multi-monitor lamp
AUTO	Red/Blue
DRY	Green
COOL	Blue
HEAT	Red
FAN	White



Display

To stop operation

Press again.

- “**ON**” disappears from the LCD.
- The multi-monitor lamp goes off.

To change the temperature setting

Press .

- Press ▲ to raise the temperature and press ▼ to lower the temperature.

COOL operation	HEAT operation	AUTO operation	DRY or FAN operation
64-90°F (18-32°C)	50-86°F (10-30°C)	64-86°F (18-30°C)	The temperature setting cannot be changed.

NOTE

Notes on AUTO operation

- In AUTO operation, the system selects an appropriate operation mode (COOL or HEAT) based on the indoor temperature and starts the operation.
- The system automatically reselects setting at a regular interval to bring the indoor temperature to the user-setting level.

Note on DRY operation

- Eliminates humidity while maintaining the indoor temperature as much as possible. It automatically controls temperature and airflow rate, so manual adjustment of these functions is unavailable.



Adjusting the Airflow Rate

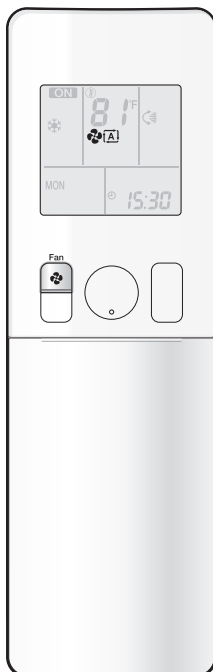



You can adjust the airflow rate to increase your comfort.

To adjust the airflow rate setting

Press .

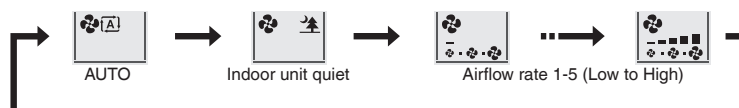
- Each pressing of  changes the airflow rate setting in sequence.



- When the airflow is set to “”, quiet operation starts and noise from the indoor unit will become quieter.
- In the quiet operation mode, the airflow rate is set to a weak level.
- In DRY operation, the airflow rate setting cannot be changed.

NOTE

Note on airflow rate setting

- At smaller airflow rates, the cooling (heating) effect is also smaller.

Tips for saving energy

Keeping the temperature setting at a moderate level helps save energy.

- Recommended temperature setting
 - For cooling: 78-82°F (26-28°C)
 - For heating: 68-75°F (20-24°C)

Cover windows with a blind or a curtain.

- Blocking sunlight and air from outdoors increases the cooling (heating) effect.

Keep the air filter clean.

- Clogged air filters cause inefficient operation and waste energy. Clean them once in about every 2 weeks. [▶ Page 30](#)

If you are not going to use the air conditioner for a long period, for example in spring or autumn, turn off the circuit breaker.

- The air conditioner always consumes a small amount of electricity even while it is not operating.





Adjusting the Airflow Direction

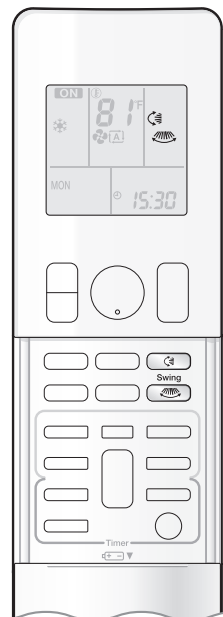

You can adjust the airflow direction to increase your comfort.

CAUTION

- Always use a remote controller to adjust the angles of the flaps and louvers.
 - If you attempt to move the flaps and louvers forcibly by hand when they are swinging, the mechanism may be damaged.
 - Inside the air outlet, a fan is rotating at a high speed.

To start auto swing

Up and down airflow direction

Press .

- “” is displayed on the LCD.
- The flaps (horizontal blades) will begin to swing.

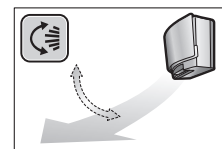

Right and left airflow direction



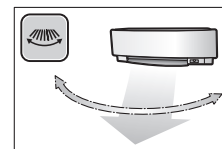

Press .

- “” is displayed on the LCD.
- The louvers (vertical blades) will begin to swing.



The 3-D airflow direction

Press  and .

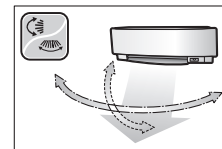

- “” and “” are displayed on the LCD.
- The flaps and louvers move in turn.
- To cancel 3-D airflow, press either  or  again. The flaps or louvers will stop moving.



To set the flaps or louvers at the desired position

- This function is effective while the flaps or louvers are in auto swing mode.

Press  and  when the flaps or louvers reach the desired position.

- In the 3-D airflow, the flaps and louvers move in turn.
- “” or “” disappears from the LCD.

NOTE

Notes on airflow direction setting

- The movable range of the flaps varies according to the operation mode.
- The flaps will stop at the upper position when the airflow rate is changed to low during the up and down swing setting.

Note on 3-D airflow

- Using 3-D airflow circulates cold air, which tends to collect at the bottom of the room, and hot air, which tends to collect near the ceiling, throughout the room, preventing areas of cold and hot developing.

Movable range of the flaps

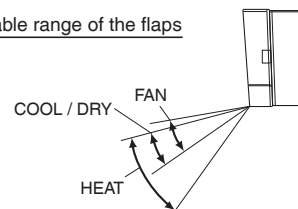



COMFORT AIRFLOW / INTELLIGENT EYE Operation

COMFORT AIRFLOW operation: The airflow direction is upward while in COOL operation, and downward while in HEAT operation. This function prevents cold or warm air from blowing directly on the occupants in the room.

INTELLIGENT EYE operation: The INTELLIGENT EYE sensor detects human movement and adjusts the right and left airflow direction to avoid blowing air directly on the person. If no one is in the room for more than 20 minutes, the operation automatically changes to energy saving operation. The INTELLIGENT EYE sensor works differently depending on the situation.

INTELLIGENT EYE operation is useful for energy saving

■ A person is detected in area 1.

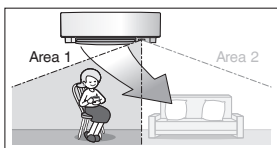

■ A person is detected in area 2.

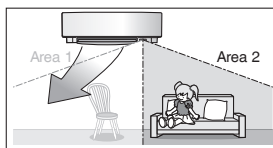

■ People are detected in both areas.

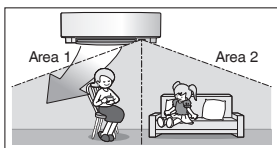

■ No people are detected in the areas.

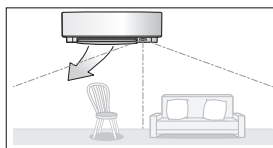

Use the INTELLIGENT EYE operation in combination with the COMFORT AIRFLOW operation.

The air conditioner will switch to energy saving mode after 20 minutes.

*The airflow direction may differ from the illustrated direction depending on the actions and movements of the people in the areas.

Energy saving operation

- If no presence is detected in the room for 20 minutes, the energy saving operation will start, and the INTELLIGENT EYE lamp goes off.
- This operation changes the temperature by -3.6°F (-2°C) in HEAT / $+3.6^{\circ}\text{F}$ ($+2^{\circ}\text{C}$) in COOL / $+3.6^{\circ}\text{F}$ ($+2^{\circ}\text{C}$) in DRY operation from the set temperature.
When the room temperature exceeds 86°F (30°C), the operation changes the temperature by $+1.8^{\circ}\text{F}$ ($+1^{\circ}\text{C}$) in COOL / $+1.8^{\circ}\text{F}$ ($+1^{\circ}\text{C}$) in DRY operation from the set temperature.
- This operation decreases the airflow rate slightly in FAN operation only.



COMFORT AIRFLOW / INTELLIGENT EYE Operation

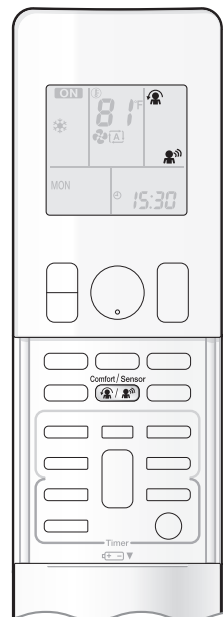

⚠ CAUTION

- Do not place large objects near the INTELLIGENT EYE sensor. Also keep heating units and humidifiers outside the sensor's detection area. This sensor can detect undesirable objects.
- Do not hit or violently push the INTELLIGENT EYE sensor. This can lead to damage and malfunction.



To start operation

Press  and select the desired mode.

- Each time  is pressed, a different setting option is displayed on the LCD.
- When INTELLIGENT EYE is selected, the INTELLIGENT EYE lamp lights green.





Display

- By selecting “ ” from the following icons, the air conditioner will switch to COMFORT AIRFLOW operation combined with INTELLIGENT EYE operation.



- When the flaps (horizontal blades) are swinging, selecting any of the modes above will cause the flaps (horizontal blades) to stop.
- The lamp lights when human movement is detected.

COMFORT AIRFLOW / INTELLIGENT EYE operation settings

Display	Operation mode	Explanation
	COMFORT AIRFLOW	The flaps adjust the airflow direction upward while cooling, downward while heating. ▶Page 14
	INTELLIGENT EYE	The sensor detects the movement of people in the sensing areas and the louvers adjust the airflow direction to an area where people are not present. When there are no people in the sensing areas, the air conditioner switches to the energy saving mode. ▶Page 14
	COMFORT AIRFLOW and INTELLIGENT EYE	The air conditioner will be in COMFORT AIRFLOW operation combined with INTELLIGENT EYE operation. ▶Page 14
Blank	No function	–

To cancel operation

Press  until no icon is displayed.

- If the INTELLIGENT EYE operation was being used, the INTELLIGENT EYE lamp goes off.

NOTE

■ Notes on COMFORT AIRFLOW operation

- The position of the flaps will change, preventing air from blowing directly on the occupants of the room.
- POWERFUL operation and COMFORT AIRFLOW operation cannot be used at the same time. Priority is given to the function of whichever button is pressed last.
- The airflow rate will be set to AUTO. If the up and down airflow direction is selected, COMFORT AIRFLOW operation will be canceled.

■ Notes on INTELLIGENT EYE operation

- Application range is as follows.

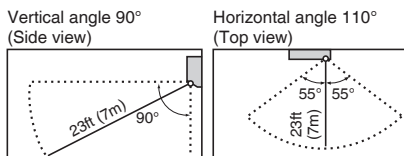

- While the air conditioner is in INTELLIGENT EYE operation, the louvers adjust the airflow direction if there are people in the sensing areas of the INTELLIGENT EYE so that the leftward or rightward airflow will not be directed to the people. If no people are detected in either area 1 or 2 for 20 minutes, the air conditioner switches to the energy saving mode with the set temperature shifted by 3.6°F (2°C). The air conditioner may switch to the energy saving operation even if there are people in the areas. This may occur depending on the clothes the people are wearing, if there is no movement of the people in the areas.
- The airflow direction from the louvers will be leftward if there are people in both areas 1 and 2. The air will also flow left if there is a person right in front of the sensor as the sensor judges that there are people in both areas.
- Due to the position of the sensor, people might be exposed to the airflow of the indoor unit if they are close to the front side of the indoor unit. If there are people close to the front side of the indoor unit or in both areas, it is recommended to use the COMFORT AIRFLOW and INTELLIGENT EYE operations simultaneously. Using both modes together, the air conditioner will not direct the airflow towards the people.
- The sensor may not detect moving objects further than 23ft (7m) away. (Please see the application range.)
- Sensor detection sensitivity changes according to the indoor unit location, the speed of passers-by, temperature range, etc.
- The sensor could also mistakenly detect pets, sunlight, fluttering curtains and light reflected off of mirrors as passers-by.
- INTELLIGENT EYE operation will not switch on during POWERFUL operation.
- NIGHT SET mode [▶ Page 20](#) will not switch on during use of INTELLIGENT EYE operation.

■ Notes on combining COMFORT AIRFLOW operation and INTELLIGENT EYE operation

- The airflow rate will be set to AUTO. If the up and down airflow direction is selected, COMFORT AIRFLOW operation will be canceled. Priority is given to the function of whichever button is pressed last.
- When the INTELLIGENT EYE sensor detects the movement of people, it adjusts the airflow direction upward (while in COOL operation) and downward (while in HEAT operation), by adjusting the flaps. When the sensor detects people, the louvers will direct the airflow in such a way that it will not be blown directly on them. If there are no people, the air conditioner will switch to energy saving operation after 20 minutes.



POWERFUL Operation

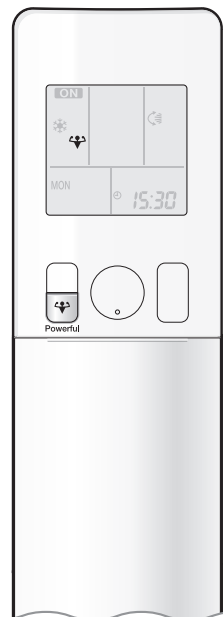

POWERFUL operation quickly maximizes the cooling (heating) effect in any operation mode. In this mode, the air conditioner operates at maximum capacity.

To start POWERFUL operation

Press  during operation.

- “” is displayed on the LCD.
- POWERFUL operation ends in 20 minutes. Then the system automatically operates again with the previous settings which were used before POWERFUL operation.



To cancel POWERFUL operation

Press  again.

- “” disappears from the LCD.

NOTE

Notes on POWERFUL operation

- Pressing  causes the settings to be canceled, and “” disappears from the LCD.
- POWERFUL operation will not increase the capacity of the air conditioner if the air conditioner is already in operation with its maximum capacity demonstrated.
 - In COOL, HEAT and AUTO operation
To maximize the cooling (heating) effect, the capacity of outdoor unit increases and the airflow rate becomes fixed at the maximum setting. The temperature and airflow settings cannot be changed.
 - In DRY operation
The temperature setting is lowered by 4.5°F (2.5°C) and the airflow rate is slightly increased.
 - In FAN operation
The airflow rate is fixed at the maximum setting.
 - When using priority room setting
Refer to “Note for Multi System”. [▶ Page 27](#)

Regarding the combination of POWERFUL and other operations

POWERFUL + COMFORT AIRFLOW	Not available*
POWERFUL + ECONO	
POWERFUL + QUIET OUTDOOR UNIT	

*Priority is given to the function of whichever button is pressed last.



ECONO / QUIET OUTDOOR UNIT Operation

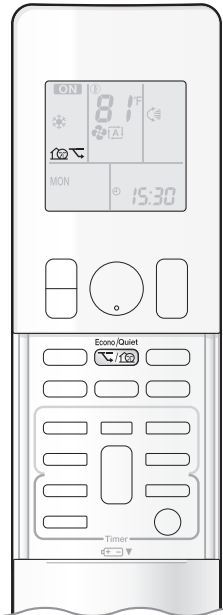

ECONO operation enables efficient operation by limiting the maximum power consumption.

This function is useful to prevent the circuit breaker from tripping when the unit operates alongside other appliances on the same circuit.

QUIET OUTDOOR UNIT operation lowers the noise level of the outdoor unit by changing the frequency and fan speed of the outdoor unit. This function is convenient during the night-time operation.

To start operation

Press  and select the desired mode.

- Each time  is pressed, a different setting option is displayed on the LCD.





To cancel operation

Press  until no icon is displayed.

NOTE

Notes on ECONO operation

- Pressing  causes the settings to be canceled, and "  " disappears from the LCD.
- If the power consumption level is already low, switching to ECONO operation will not reduce the power consumption.

Notes on QUIET OUTDOOR UNIT operation

- If using a multi system, the QUIET OUTDOOR UNIT operation will work only when this function is set on all operated indoor units. However, if using priority room setting, refer to "Note for Multi System". [▶ Page 27](#)
- Even if the operation is stopped by using the remote controller or the indoor unit ON/OFF switch when using QUIET OUTDOOR UNIT operation, "  " will remain displayed on the remote controller.
- QUIET OUTDOOR UNIT operation will not reduce the frequency nor fan speed if they already are operating at reduced levels.
- This operation is performed with lower power and therefore may not provide a sufficient cooling (heating) effect.

Possible combinations of ECONO / QUIET OUTDOOR UNIT operation and basic operations

	Operation mode				
	AUTO	DRY	COOL	HEAT	FAN
ECONO	✓	✓	✓	✓	—
QUIET OUTDOOR UNIT	✓	—	✓	✓	—



ON/OFF TIMER Operation

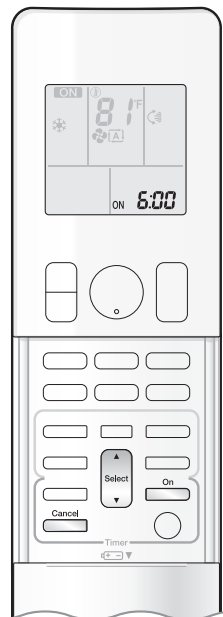

Timer functions are useful for automatically switching the air conditioner on or off at night or in the morning. You can also use the ON TIMER and OFF TIMER together.

To use ON TIMER operation

- Check that the clock is correct.
If not, set the clock to the present time. ▶ [Page 10](#)

1. Press .



“6:00” is displayed on the LCD.
“ON” blinks.

- “⊕” and day of the week disappear from the LCD.

2. Press until the time setting reaches the point you like.

- Each pressing of either button increases or decreases the time setting by 10 minutes.
Holding down either button changes the setting rapidly.

3. Press again.

- The multi-monitor lamp blinks twice.
- “ON” and setting time are displayed on the LCD.
- The TIMER lamp periodically lights orange. ▶ [Page 5](#)



Display

To cancel ON TIMER operation

Press .

- “ON” and setting time disappear from the LCD.
- “⊕” and day of the week are displayed on the LCD.

NOTE

Notes on TIMER operation

- When TIMER is set, the present time is not displayed.
- When using the ON/OFF TIMER to start/stop operation, the actual operation start/stop time may differ from the time set. (Maximum of about 10 minutes)

In the following cases, set the timer again.

- After the circuit breaker has turned off.
- After a power failure.
- After replacing the batteries in the remote controller.

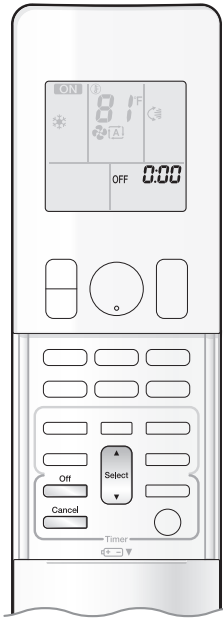

To use OFF TIMER operation

- Check that the clock is correct.
If not, set the clock to the present time. ▶ Page 10

1. Press .



“ 0:00 ” is displayed on the LCD.
“ OFF ” blinks.

- “ ☉ ” and day of the week disappear from the LCD.

2. Press until the time setting reaches the point you like.

- Each pressing of either button increases or decreases the time setting by 10 minutes.
Holding down either button changes the time setting rapidly.

3. Press again.

- The multi-monitor lamp blinks twice.
- “ OFF ” and setting time are displayed on the LCD.
- The TIMER lamp periodically lights orange. ▶ Page 5



Display

To cancel OFF TIMER operation

Press .

- “ OFF ” and setting time disappear from the LCD.
- “ ☉ ” and day of the week are displayed on the LCD.

To combine ON TIMER and OFF TIMER operation

- A sample setting for combining the 2 timers is shown below.

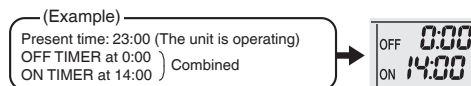

NOTE

NIGHT SET mode

- When the OFF TIMER is set, the air conditioner automatically adjusts the temperature setting (0.9°F (0.5°C) up in COOL, 3.6°F (2.0°C) down in HEAT) to prevent excessive cooling (heating) during sleeping hours.



WEEKLY TIMER Operation

Up to 4 timer settings can be saved for each day of the week. This is convenient to adapt the WEEKLY TIMER to your family's lifestyle.

Setting example of the WEEKLY TIMER

The same timer settings are used from Monday through Friday, while different timer settings are used for the weekend.

<p>[Monday]</p>	<p>Make timer settings for programs 1-4. ▶Page 22</p>
<p>[Tuesday to Friday]</p>	<p>Use the copy mode to make settings for Tuesday to Friday, because these settings are the same as those for Monday. ▶Page 24</p>
<p>[Saturday]</p>	<p>No timer settings</p>
<p>[Sunday]</p>	<p>Make timer settings for programs 1-4. ▶Page 22</p>

- Up to 4 reservations per day and 28 reservations per week can be set using the WEEKLY TIMER. The effective use of the copy mode simplifies timer programming.
- The use of ON-ON-ON-ON settings, for example, makes it possible to schedule operating mode and set temperature changes. Furthermore, by using OFF-OFF-OFF-OFF settings, only the turn off time of each day can be set. This will turn off the air conditioner automatically if you forget to turn it off.

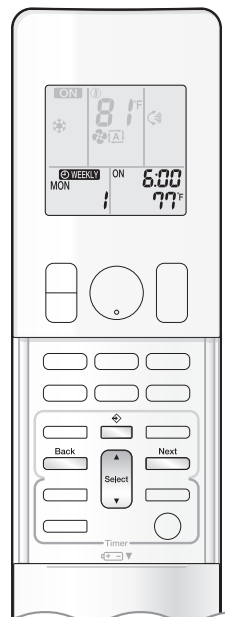

To use WEEKLY TIMER operation

Setting mode

- Make sure the day of the week and time are set.
If not, set the day of the week and time. ▶ [Page 10](#)

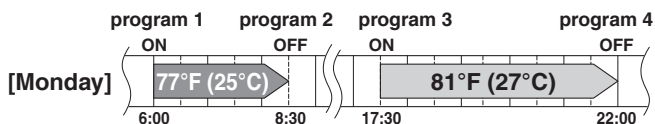

Setting Displays

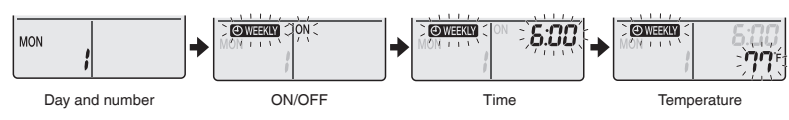

1. Press .

- The day of the week and the reservation number of the current day will be displayed.
- 1 to 4 settings can be made per day.

2. Press to select the desired day of the week and reservation number.

- Pressing changes the reservation number and the day of the week.

3. Press .

- The day of the week and reservation number will be set.
- “ WEEKLY” and “ON” blink.

4. Press to select the desired mode.

- Pressing changes the “ON” or “OFF” setting in sequence.



- In case the reservation has already been set, selecting “blank” deletes the reservation.
- Proceed to **STEP 9** if “blank” is selected.
- To return to the day of the week and reservation number setting, press .

5. Press .

- The ON/OFF TIMER mode will be set.
- “ WEEKLY” and the time blink.



WEEKLY TIMER Operation

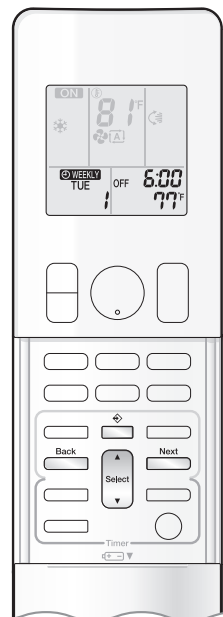

6. Press to select the desired time.

- The time can be set between 0:00 and 23:50 in 10-minute intervals.
- To return to the ON/OFF TIMER mode setting, press  .
- Proceed to **STEP 9** when setting the OFF TIMER.

7. Press .

- The time will be set.
- “ WEEKLY ” and the temperature blink.

8. Press to select the desired temperature.

- The temperature can be set between 50°F (10°C) and 90°F (32°C).
COOL or AUTO: The unit operates at 64°F (18°C) even if it is set at 50°F (10°C) to 63°F (17°C). [▶ Page 11](#)
HEAT or AUTO : The unit operates at 86°F (30°C) even if it is set at 87°F (31°C) to 90°F (32°C). [▶ Page 11](#)
- To return to the time setting, press  .
- The set temperature is only displayed when the mode setting is on.

9. Press .

- Be sure to direct the remote controller toward the indoor unit and check for a receiving tone and blinking of the multi-monitor lamp.
- The multi-monitor lamp blinks twice.
- Temperature and time are set in the case of ON TIMER operation, and the time is set in the case of OFF TIMER operation.
- The next reservation screen will appear.
- To continue further settings, repeat the procedure from **STEP 4**.

10. Press to complete the setting.

- “ WEEKLY ” is displayed on the LCD and WEEKLY TIMER operation is activated.
- The TIMER lamp periodically lights orange. [▶ Page 5](#)

The multi-monitor lamp will not light orange if all the reservation settings are deleted.





Display

- A reservation made once can be easily copied and the same settings used for another day of the week. Refer to [Copy mode](#) . [▶ Page 24](#)

NOTE

Notes on WEEKLY TIMER operation

- Do not forget to set the clock on the remote controller first. [▶ Page 10](#)
- The day of the week, ON/OFF TIMER mode, time and set temperature (only for ON TIMER mode) can be set with the WEEKLY TIMER. Other settings for the ON TIMER are based on the settings just before the operation.
- WEEKLY TIMER and ON/OFF TIMER operation cannot be used at the same time. The ON/OFF TIMER operation has priority if it is set while WEEKLY TIMER is still active. The WEEKLY TIMER will enter the standby state, and “ WEEKLY ” will disappear from the LCD. When the ON/OFF TIMER is up, the WEEKLY TIMER will automatically become active.
- Turning off the circuit breaker, power failure, and other similar events will render operation of the indoor unit's internal clock inaccurate. Reset the clock. [▶ Page 10](#)
-  can be used only for the time and temperature settings. It cannot be used to go back to the reservation number.

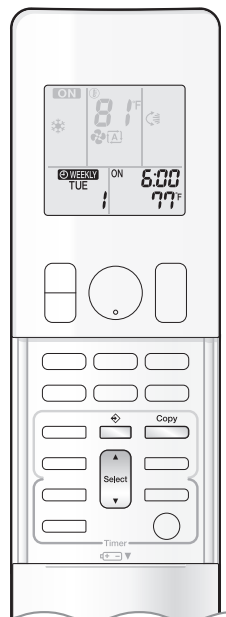

Copy mode

- A reservation made once can be copied to another day of the week. The whole reservation of the selected day of the week will be copied.

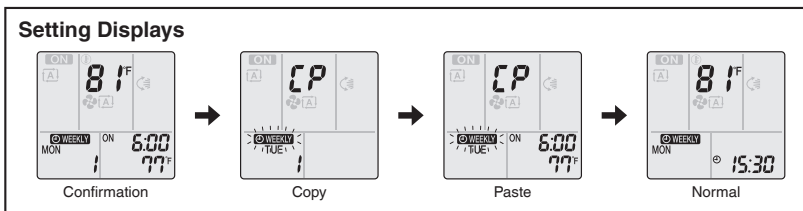
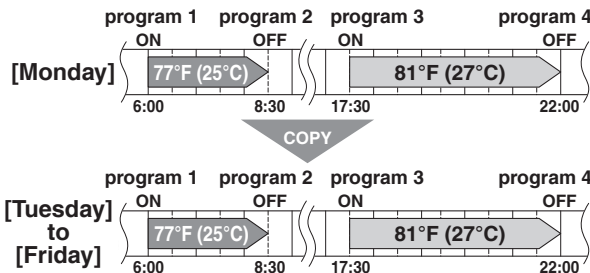

1. Press .
2. Press to confirm the day of the week to be copied.
3. Press .
 - The whole reservation of the selected day of the week will be copied.
4. Press to select the destination day of the week.
5. Press .
 - The multi-monitor lamp blinks twice.
 - The reservation will be copied to the selected day of the week. The whole reservation of the selected day of the week will be copied.
 - To continue copying the settings to other days of the week, repeat **STEP 4** and **STEP 5**.
6. Press to complete the setting.
 - “ WEEKLY” is displayed on the LCD and WEEKLY TIMER operation is activated.
 - The TIMER lamp periodically lights orange.

NOTE

Note on COPY MODE

- The entire reservation of the source day of the week is copied in the copy mode.
- In the case of making a reservation change for any day of the week individually after copying the content of weekly reservations, press and change the settings in the steps of **Setting mode** **Page 22**



WEEKLY TIMER Operation

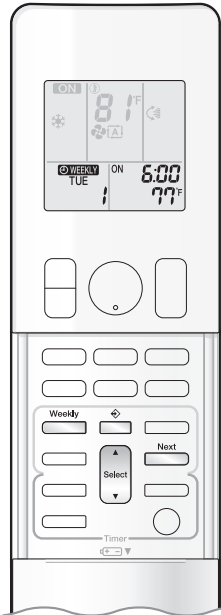

Confirming a reservation

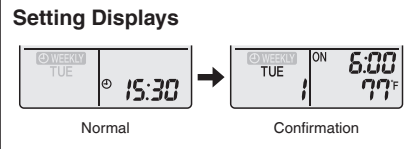

- The reservation can be confirmed.



1. Press .

- The day of the week and the reservation number of the current day will be displayed.

2. Press to select the day of the week and the reservation number to be confirmed.

- Pressing  displays the reservation details.
- To change the confirmed reserved settings, select the reservation number and press . The mode is switched to setting mode. Proceed to **Setting mode STEP 4.** [▶Page 22](#)

3. Press to exit the confirmation mode.



- “ WEEKLY” is displayed on the LCD and WEEKLY TIMER operation is activated.
- The TIMER lamp periodically lights orange. [▶Page 5](#)
- The multi-monitor lamp will not light orange if all the reservation settings are deleted.



Display

To deactivate WEEKLY TIMER operation

Press while “ WEEKLY” is displayed on the LCD.

- “ WEEKLY” disappears from the LCD.
- To reactivate the WEEKLY TIMER operation, press  again.
- If a reservation deactivated with  is activated once again, the last reservation mode will be used.

NOTE

- If not all the reservation settings are reflected, deactivate the WEEKLY TIMER operation once. Then press  again to reactivate the WEEKLY TIMER operation.

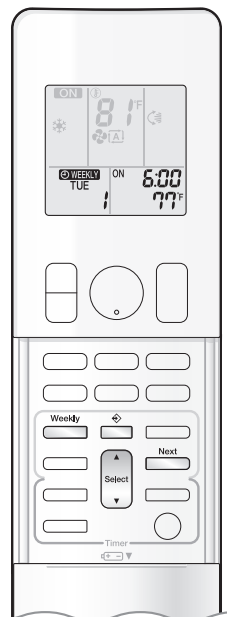

To delete reservations

An individual reservation

- 1. Press** .
 • The day of the week and the reservation number will be displayed.
- 2. Press** **to select the day of the week and the reservation number to be deleted.**
- 3. Press** .
 • “ WEEKLY” and “ON” or “OFF” blink.
- 4. Press** **until no icon is displayed.**
 • Pressing changes the ON/OFF TIMER mode in sequence.
 • Selecting “blank” will cancel any reservation you may have.



- 5. Press** .
 • The selected reservation will be deleted.
- 6. Press** .
 • If there are still other reservations, WEEKLY TIMER operation will be activated.

Reservations for each day of the week

- This function can be used for deleting reservations for each day of the week.
 - It can be used while confirming or setting reservations.
- 1. Press** .
 • The day of the week and the reservation number will be displayed.
 - 2. Press** **to select the day of the week to be deleted.**
 - 3. Hold** **for about 5 seconds.**
 • The reservation of the selected day of the week will be deleted.
 - 4. Press** .
 • If there are still other reservations, WEEKLY TIMER operation will be activated.

All reservations

- **Hold** **for about 5 seconds with the normal display.**
 - Be sure to direct the remote controller toward the indoor unit and check for a receiving tone.
 - This operation cannot be used for the WEEKLY TIMER setting display.
 - All reservations will be deleted.

Note for Multi System

A multi system has one outdoor unit connected to multiple indoor units.

Selecting the operation mode

When the priority room setting is active but the set unit is not operating or when the priority room setting is inactive

When more than one indoor unit is operating, priority is given to the first unit that was turned on.

In this case, set the units that are turned on later to the same operation mode as the first unit.

Otherwise, they will enter the standby state, and the multi-monitor lamp will blink; this does not indicate malfunction.

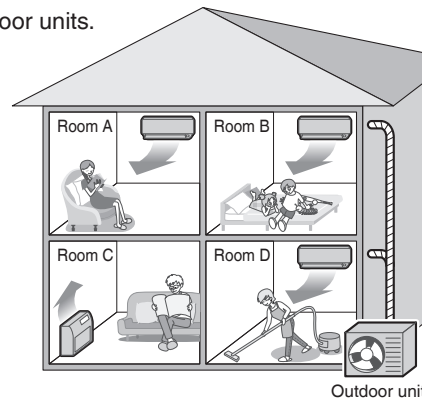

NOTE

Notes on operation mode for a multi system

- COOL, DRY and FAN operation may be used at the same time.
- AUTO operation automatically selects COOL operation or HEAT operation based on the indoor temperature. Therefore, AUTO operation is available when selecting the same operation mode as that of the room with the first unit to be turned on.

CAUTION

- Normally, the operation mode in the room where the unit is first started is given priority, but the following situations are exceptions to this rule. If the operation mode of the first room is FAN operation, then using HEAT operation in any room after this will give priority to HEAT operation. In this situation, the indoor unit operating in FAN mode will switch to standby, and the multi-monitor lamp will blink.

With the priority room setting active

Refer to “**Priority room setting**” on the next page.

NIGHT QUIET mode (Available only for COOL operation)

NIGHT QUIET mode requires initial programming during installation. Please consult your retailer or dealer for assistance.

NIGHT QUIET mode reduces the operation noise of the outdoor unit during the night-time hours to prevent annoyance to neighbors.

- NIGHT QUIET mode is activated when the temperature drops 10.8°F (6°C) or more below the highest temperature recorded that day. When the temperature difference between the current outdoor temperature and the maximum outdoor temperature becomes less than 7.2°F (4°C), this function will be canceled.
- NIGHT QUIET mode slightly reduces the cooling efficiency of the unit.

QUIET OUTDOOR UNIT operation

Refer to “**QUIET OUTDOOR UNIT Operation**”. ▶ **Page 18**

When the priority room setting is active but the set unit is not operating or when the priority room setting is inactive

When using the QUIET OUTDOOR UNIT operation feature with a multi system, set all indoor units to QUIET OUTDOOR UNIT operation using their remote controllers.

When canceling QUIET OUTDOOR UNIT operation, simply cancel the mode on one of the operating indoor units using their remote controller.

However QUIET OUTDOOR UNIT operation will remain displayed on the remote controllers for the other rooms.

We recommend you cancel operation in all rooms using their remote controllers.

With the priority room setting active

Refer to “**Priority room setting**” on the next page.

COOL/HEAT mode lock

The COOL/HEAT mode lock requires initial programming during installation. Please consult your authorized dealer for assistance. The COOL/HEAT mode lock sets the unit forcibly to either COOL or HEAT operation. This function is convenient when you wish to set all indoor units connected to the multi system to the same operation mode.

NOTE

- The COOL/HEAT mode lock cannot be activated together with the priority room setting.

Priority room setting (Not available on some models)

The priority room setting requires initial programming during installation. Please consult your authorized dealer for assistance. The room designated as the priority room takes priority in the following situations.

Operation mode priority

- As the operation mode of the priority room takes precedence, you can select a different operation mode from other rooms.

[Example]

- Room A is the priority room in this example.
When COOL operation is selected in room A while operating the following modes in room B, C and D:

Operation mode in room B, C and D	Status of room B, C and D when the unit in room A is in COOL operation
COOL or DRY or FAN	The current operation mode is maintained.
HEAT	The unit enters the standby mode. Operation resumes when the room A unit stops operating.
AUTO	If the unit is set to COOL operation, it continues. If the unit is set to HEAT operation, it enters the standby mode. Operation resumes when the room A unit stops operating.

Priority when POWERFUL operation is used

[Example]

- Room A is the priority room in this example.
The indoor units in rooms A, B, C and D are all operating. If the unit in room A enters POWERFUL operation, operation capacity will be concentrated in room A. In such a case, the cooling (heating) efficiency of the units in room B, C and D may be slightly reduced.

Priority when QUIET OUTDOOR UNIT operation is used

[Example]

- Room A is the priority room in this example.
Just by setting the unit in room A to QUIET operation, the air conditioner starts QUIET OUTDOOR UNIT operation. You do not have to set all the indoor units in operation to QUIET OUTDOOR UNIT operation.

Care and Cleaning

⚠ CAUTION

- Before cleaning, be sure to stop the operation and turn off the circuit breaker.
- Do not touch the aluminum fins of the indoor unit. If you touch those parts, this may cause an injury.

■ Quick reference

How to open the upper front panel

- 1) Hold the upper front panel by the sides and open it.
- 2) Fix the panel with the panel support plate.

How to close the upper front panel

- 1) Return the panel support plate to its previous position.
- 2) Turn the unit on and then off to close the panel properly.
 - See instructions in “Reattach the filters and close the upper front panel.” for a more detailed description.

▶ Page 30,31

Cleaning parts

Upper and lower front panels

- With the panels closed, wipe them with a soft damp cloth.

If dirty

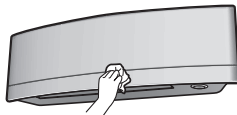

Air filter

- Vacuum dust or wash the filter.

Once every 2 weeks

▶ Page 30

Titanium apatite deodorizing filter

- Vacuum dust or replace the filter.

[Cleaning]

Once every 6 months

▶ Page 31

[Replacement]

Once every 3 years

▶ Page 31

Indoor unit and remote controller

- Wipe them with a soft cloth.

If dirty

Notes on cleaning

For cleaning, do not use any of the following:

- Water hotter than 104°F (40°C)
- Volatile liquid such as benzene, gasoline and thinner
- Polishing compounds
- Rough materials such as a scrubbing brush
- Sprays such as deodorizers

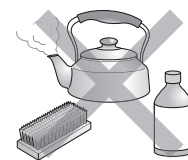

■ Air filter

1. Pull out the air filters.

- 1) Open the upper front panel.
- 2) Set the panel support plate between the ribs on the unit to fix the upper front panel.
- 3) Push the filter tab at the center of each air filter a little upwards, then pull it down.

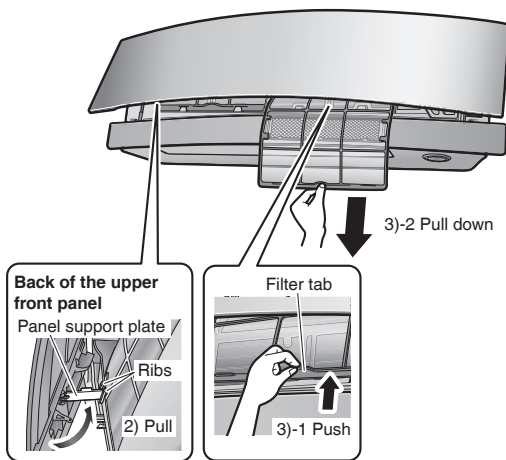

2. Wash the air filters with water or clean them with a vacuum cleaner.

- It is recommended to clean the air filters every 2 weeks.

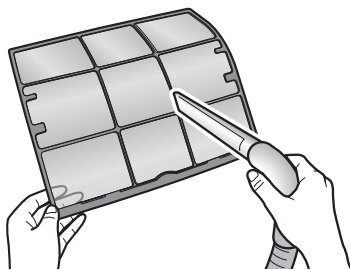

If the dust does not come off easily

- Wash the air filters with neutral detergent thinned with lukewarm water, then let them dry in the shade.
- Be sure to remove the titanium apatite deodorizing filter. Refer to "Titanium apatite deodorizing filter" on the next page.

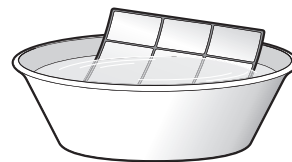

3. Reattach the filters and close the upper front panel.

- 1) Return the panel support plate to its previous position and close the upper front panel slowly.

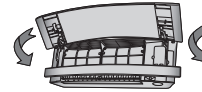

- 2) Do not push on the panel to close it.



- 3) Turn on the unit using the remote controller. Wait till the upper and lower front panels are completely open. Then, turn off the unit using the remote controller again.



- 4) Once the both panels close completely, gently push the upper front panel to hook it into position.



Care and Cleaning

■ Titanium apatite deodorizing filter

1. Take off the titanium apatite deodorizing filters.

- 1) Open the upper front panel and pull out the air filters.
- 2) Hold the recessed parts of the frame and unhook the 4 claws.

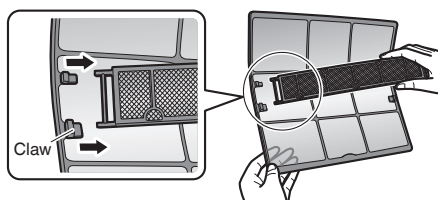

2. Clean or replace the titanium apatite deodorizing filters.

[Cleaning]

- 1) Vacuum dust, and soak in lukewarm water or water for about 10 to 15 minutes if very dirty.

- Do not remove the filter from the frame when washing with water.

- 2) After washing, shake off remaining water and let them dry in the shade.

- Do not wring out the filter to remove water from it.

[Replacement]

Remove the filter from the filter frame and attach a new one.

- Do not throw away the filter frame. Reuse the filter frame when replacing the titanium apatite deodorizing filter.
- When attaching the filter, check that the filter is properly set in the tabs.

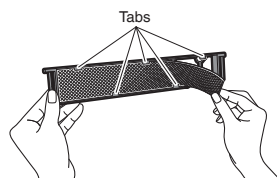

- Dispose of the old filter as non-flammable waste.

3. Reattach the filters and close the upper front panel.

- 1) Return the panel support plate to its previous position and close the upper front panel slowly.



- 2) Do not push on the panel to close it.



- 3) Turn on the unit using the remote controller. Wait till the upper and lower front panels are completely open. Then, turn off the unit using the remote controller again.



- 4) Once the both panels close completely, gently push the upper front panel to hook it into position.







NOTE

- Operation with dirty filters:
 - cannot deodorize the air,
 - cannot clean the air,
 - results in poor heating or cooling,
 - may cause odor.
- Dispose of old filters as non-flammable waste.
- To order a titanium apatite deodorizing filter, contact the dealer where you bought the air conditioner.

Item	Titanium apatite deodorizing filter (set of 2)
Part No.	KAF970A46 (without frame)

■ Prior to a long period of non-use

1. Operate the FAN mode for several hours to dry out the inside.

- 1) Press  and select “”.
 - When a multi outdoor unit is connected, make sure the HEAT operation is not being used in other rooms before you use the FAN operation. 
- 2) Press  and start the operation.

2. After operation stops, turn off the circuit breaker for the room air conditioner.

3. Clean the air filters and reattach them.

4. To prevent battery leakage, take out the batteries from the remote controller.

■ We recommend periodical maintenance

- In certain operating conditions, the inside of the air conditioner may get foul after several seasons of use, resulting in poor performance. It is recommended to have periodical maintenance by a qualified contractor in addition to regular cleaning by the user.
- For qualified contractor maintenance, please contact the dealer where you bought the air conditioner.

FAQ

Indoor unit

The flaps do not start swinging immediately.

- The air conditioner is adjusting the position of the flaps. The flaps will start moving soon.

The air conditioner stops generating airflow during HEAT operation.

- Once the set temperature is reached, the airflow rate is reduced and operation stopped in order to avoid generating a cool airflow. Operation will resume automatically when the indoor temperature falls.

HEAT operation stops suddenly and a flowing sound is heard.

- The outdoor unit is defrosting. HEAT operation starts after the frost on the outdoor unit has been removed. This can take about 4 to 12 minutes.

Operation does not start soon.

- **When the unit is turned on again soon after being turned off.**
- **When the mode was reselected.**
 - This is to protect the air conditioner. You should wait for about 3 minutes.

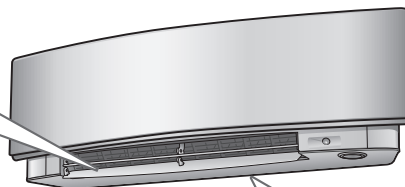

Different sounds are heard.

- **A sound like flowing water**
 - This sound is generated because the refrigerant in the air conditioner is flowing.
 - This is a pumping sound of the water in the air conditioner and can be heard when the water is pumped out from the air conditioner during COOL or DRY operation.
 - The refrigerant flows in the air conditioner even if the air conditioner is not working when the indoor units in other rooms are in operation.
- **Blowing sound**
 - This sound is generated when the flow of the refrigerant in the air conditioner is switched over.
- **Ticking sound**
 - This sound is generated when the cabinet and frame of the air conditioner slightly expand or shrink as a result of temperature changes.
- **Whistling sound**
 - This sound is generated when refrigerant flows during defrosting operation.
- **Clicking sound during operation or idle time**
 - This sound is generated when the refrigerant control valves or the electrical parts operate.
- **Clopping sound**
 - This sound is heard from the inside of the air conditioner when the exhaust fan is activated while the room doors are closed. Open the window or turn off the exhaust fan.

Outdoor unit

Operating sound is loud.

- When frost forms on the heat exchanger of the outdoor unit, the operating sound level increases slightly.

The outdoor unit emits water or steam.

- **In HEAT operation**
 - The frost on the outdoor unit melts into water or steam when the air conditioner is in defrosting operation.
- **In COOL or DRY operation**
 - Moisture in the air condenses into water on the cool surface of the outdoor unit piping and drips.

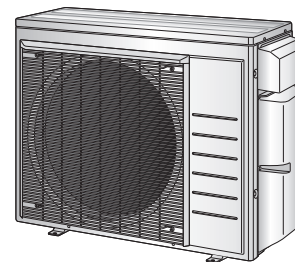

Troubleshooting

Before making an inquiry or a request for repair, please check the following.
If the problem persists, consult your dealer.



Not a problem

This case is not a problem.



Check

Please check again before requesting repairs.

The air conditioner does not operate

Case	Description / what to check
Multi-monitor lamp is off.	<ul style="list-style-type: none"> • Has the circuit breaker been tripped or the fuse blown? • Is there a power failure? • Are batteries set in the remote controller? • Is the timer setting correct?
Multi-monitor lamp is blinking.	<ul style="list-style-type: none"> • Check the error code and consult your dealer. ▶ Page 38

The air conditioner suddenly stops operating

Case	Description / what to check
Multi-monitor lamp is on.	<ul style="list-style-type: none"> • To protect the system, the air conditioner may stop operating after sudden large voltage fluctuations. It automatically resumes operation in about 3 minutes.
Multi-monitor lamp is blinking.	<ul style="list-style-type: none"> • Are the air filters dirty? Clean the air filters. • Is there anything blocking the air inlet or air outlet of the indoor unit or outdoor unit? Stop operation and after turning off the circuit breaker, remove the obstruction. Then restart operation with the remote controller. If the multi-monitor lamp is still blinking, check the error code and consult your dealer. ▶ Page 38 • Are operation modes all the same for indoor units connected to outdoor units in the multi system? If not, set all indoor units to the same operation mode and confirm that the lamps. Moreover, when the operation mode is in AUTO, set all indoor unit operation modes to COOL or HEAT for a moment and check again that the lamps are normal. If the lamps stop blinking after the above steps, there is no malfunction. ▶ Page 27

The air conditioner does not stop operating

Case	Description / what to check
The air conditioner continues operating even after operation is stopped.	<ul style="list-style-type: none"> <ul style="list-style-type: none"> ■ Immediately after the air conditioner is stopped <ul style="list-style-type: none"> • The outdoor unit fan continues rotating for about another 1 minute to protect the system. ■ While the air conditioner is not in operation <ul style="list-style-type: none"> • When the outdoor temperature is high, the outdoor unit fan may start rotating to protect the system.

The room does not cool down / warm up

Case	Description / what to check
Air does not come out.	<ul style="list-style-type: none"> <ul style="list-style-type: none"> ■ In HEAT operation <ul style="list-style-type: none"> • The air conditioner is warming up. Wait for about 1 to 4 minutes. • During defrosting operation, hot air does not flow out of the indoor unit. ■ When the air conditioner operates immediately after the circuit breaker is turned on <ul style="list-style-type: none"> • The air conditioner is preparing to operate. Wait for about 3 to 20 minutes.
Air does not come out / Air comes out.	<ul style="list-style-type: none"> <ul style="list-style-type: none"> ■ Is the airflow rate setting appropriate? <ul style="list-style-type: none"> • Is the airflow rate setting low, such as "Indoor unit quiet" or "Airflow rate 1"? Increase the airflow rate setting. ■ Is the set temperature appropriate? ■ Is the adjustment of the airflow direction appropriate?

Troubleshooting

The room does not cool down / warm up

Case	Description / what to check
Air comes out.	<ul style="list-style-type: none"> <input type="checkbox"/> Is there any furniture directly under or beside the indoor unit? <input type="checkbox"/> Is the air conditioner in ECONO operation or QUIET OUTDOOR UNIT operation? ▶Page 18 <input type="checkbox"/> Is the air filter dirty? <input type="checkbox"/> Is there anything blocking the air inlet or air outlet of the indoor unit or outdoor unit? <input type="checkbox"/> Is a window or door open? <input type="checkbox"/> Is an exhaust fan turning?

Mist comes out

Case	Description / what to check
Mist comes out of the indoor unit.	<ul style="list-style-type: none"> <input checked="" type="checkbox"/> This happens when the air in the room is cooled into mist by the cold airflow during COOL or other operation.

Remote controller

Case	Description / what to check
The unit does not receive signals from the remote controller or has a limited operating range.	<ul style="list-style-type: none"> <input checked="" type="checkbox"/> The batteries may be exhausted. Replace both batteries with new dry batteries AAA.LR03 (alkaline). For details, refer to "Preparation Before Operation". ▶Page 9 <input type="checkbox"/> Signal communication may be disabled if an electronic-starter-type fluorescent lamp (such as inverter-type lamps) is in the room. Consult your dealer if that is the case. <input type="checkbox"/> The remote controller may not function correctly if the transmitter is exposed to direct sunlight.
LCD is faint, is not working, or the display is erratic.	<ul style="list-style-type: none"> <input checked="" type="checkbox"/> The batteries may be exhausted. Replace both batteries with new dry batteries AAA.LR03 (alkaline). For details, refer to "Preparation Before Operation". ▶Page 9
Other electric devices start operating.	<ul style="list-style-type: none"> <input checked="" type="checkbox"/> If the remote controller activates other electric devices, move them away or consult your dealer.

Air has an odor

Case	Description / what to check
The air conditioner gives off an odor.	<ul style="list-style-type: none"> <input checked="" type="checkbox"/> The room odor absorbed in the unit is discharged with the airflow. We recommend you to have the indoor unit cleaned. Please consult your dealer.

Upper and lower front panels

Case	Description / what to check
Upper and lower front panels do not open. (Multi-monitor lamp is blinking.)	<ul style="list-style-type: none"> <input type="checkbox"/> Is there something caught in the upper and lower front panels? Remove the object and attempt operation again using the remote controller. If the upper and lower front panels still do not open and the multi-monitor lamp is still blinking, consult your dealer where you bought the air conditioner.
Upper front panel does not close completely.	<ul style="list-style-type: none"> <input type="checkbox"/> Are the upper front panel locks set appropriately?
If the upper and lower front panels are closed while the air conditioner is in operation, the air conditioner will stop operating and the multi-monitor lamp will blink.	<ul style="list-style-type: none"> <input checked="" type="checkbox"/> Restart the air conditioner after stopping the operation of the air conditioner with the remote controller.

Others

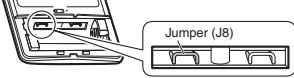
Case	Description / what to check
The air conditioner suddenly starts behaving strangely during operation.	<ul style="list-style-type: none"> <input type="checkbox"/> The air conditioner may malfunction due to lightning or radio. If the air conditioner malfunctions, turn off the power with the circuit breaker and restart the operation with the remote controller.
HEAT operation cannot be selected, even though the unit is heat pump model.	<ul style="list-style-type: none"> <input type="checkbox"/> Check that the jumper (J8) has not been cut. If it has been cut, contact your dealer. 
The ON/OFF TIMER does not operate according to the settings.	<ul style="list-style-type: none"> <input checked="" type="checkbox"/> Check if the ON/OFF TIMER and the WEEKLY TIMER are set to the same time. Change or deactivate the settings in the WEEKLY TIMER. ▶Page 21

Notes on the operating conditions

- If operation continues under any conditions other than those listed in the table,
 - A safety device may activate to stop the operation. (With a multi connection in COOL operation, the safety device may work to stop the operation of the outdoor unit only.)
 - Dew may form on the indoor unit and drip from it when COOL or DRY operation is selected.
- *1 Cutting the jumper on the outdoor unit PCB will extend the cooling operation range to 14°F (–10.0°C). Installing an air direction adjustment grille (sold separately) will further extend the operation range to –4°F (–20.0°C). Please consult your dealer.
- *2 Installing a drain pan heater (sold separately) will further extend the heating operation range to –13°F (–25.0°C). Please consult your dealer.

Mode	Operating conditions
COOL / DRY	Outdoor temperature: [MXS, MXL, MXLH models]: 14 - 115°F (–10 - 46°C) [RX models] : 50*1 - 115°F (10*1 - 46°C) *1 –4°F (–20°C) If an air direction adjustment grille (sold separately) is installed.
	Indoor temperature : 64 - 90°F (18 - 32°C) Indoor humidity : 80% max.
HEAT	Outdoor temperature: [MXS models] : 5 - 75°F (–15 - 24°C) [MXL models] : 5*2 - 75°F (–15*2 - 24°C) [MXLH models] : –13 - 75°F (–25 - 24°C) [RX models] : 5 - 75°F (–15 - 24°C) *2 –13°F (–25°C) If a drain pan heater (sold separately) is installed.
	Indoor temperature : 50 - 86°F (10 - 30°C)

■ Call your dealer immediately

 **WARNING**

When an abnormality (such as a burning smell) occurs, stop operation and turn off the circuit breaker.

- Continued operation in an abnormal condition may result in problems, electric shock or fire.
- Consult the dealer where you bought the air conditioner.

Do not attempt to repair or modify the air conditioner by yourself.

- Incorrect work may result in electric shock or fire.
- Consult the dealer where you bought the air conditioner.

If one of the following symptoms takes place, call your dealer immediately.

- The power cord is abnormally hot or damaged.
- An abnormal sound is heard during operation.
- The circuit breaker cuts off the operation frequently.
- A switch or a button often fails to work properly.
- There is a burning smell.
- Water leaks from the indoor unit.

Turn off the circuit breaker and call your dealer. 

- **After a power failure**
 - The air conditioner automatically resumes operation in about 3 minutes. Please wait for a while.
- **Lightning**
 - If there is a risk lightning could strike in the neighborhood, stop operation and turn off the circuit breaker to protect the system.

■ Disposal requirements

- Dismantling of the unit, handling of the refrigerant, oil and other parts, should be done in accordance with the relevant local and national regulations.

Troubleshooting

The multi-monitor lamp blinks

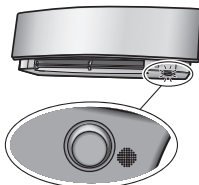

■ Check the interval time between blinks of the multi-monitor lamp.

■ If connecting to multiple indoor units

[Blink interval of about 2 to 3 seconds]

Check the operation mode of any indoor units connected in other rooms.

Because this is a multi system air conditioner, it has one outdoor unit connected to multiple indoor units in different rooms.

If the operation mode is different from the operation mode of the indoor unit in another room, the multi-monitor lamp may blink and operation may not be performed, or operation may stop while in progress.

COOL, DRY and HEAT operation may not be used at the same time.

[Blink interval of about 0.5 seconds]

This is a notification of an abnormality.

Check the error code following the procedure below, and respond according to the instructions in the table.



■ Fault diagnosis by remote controller

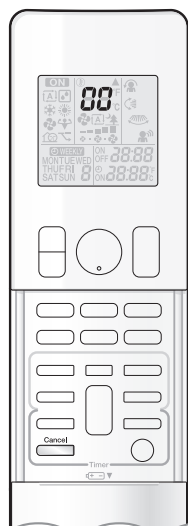

1. When **Cancel** is held down for about 5 seconds, “00” blinks in the temperature display section.

2. While pointing the remote controller at the indoor unit, press **Cancel** repeatedly.

A beep indicates a non-corresponding error code.

A long beep indicates a corresponding error code.

3. When a long beep is produced, check the error code and respond according to the instructions in the table.

- To cancel the code display, hold down **Cancel** for about 5 seconds (the code display also clears if no button is pressed for a while).

CODE	Cause	Description / what to check
E7	The fan of the outdoor unit is stopped. • Is there any foreign matter inside the outdoor unit?	After turning off the circuit breaker, remove the foreign matter, then turn the power on again and operate.
L3, L4, L5	The temperature inside the outdoor unit has become too high, so operation has stopped. • Is there anything blocking the air outlet of the outdoor unit?	After turning off the circuit breaker, remove the obstruction, then turn the power on again and operate.
Other error codes, or if the error code cannot be checked		An abnormality has occurred.

In the case of error code U0 or F3

	CODE	MEANING
SYSTEM	00	NORMAL
	UA	INDOOR-OUTDOOR UNIT COMBINATION FAULT
	U0	REFRIGERANT SHORTAGE
	U2	OVER-VOLTAGE DETECTION
	U4	SIGNAL TRANSMISSION ERROR (BETWEEN INDOOR AND OUTDOOR UNIT)
INDOOR UNIT	A1	INDOOR UNIT PCB ABNORMALITY
	A5	FREEZE-UP PROTECTION OR HEATING PEAK-CUT CONTROL
	A6	FAN MOTOR (DC MOTOR) ABNORMALITY
	C4	INDOOR HEAT EXCHANGER THERMISTOR ABNORMALITY
	C7	FRONT PANEL OPEN /CLOSE FAULT
OUTDOOR UNIT	C9	ROOM TEMPERATURE THERMISTOR ABNORMALITY
	EA	FOUR WAY VALVE ABNORMALITY
	E1	OUTDOOR UNIT PCB ABNORMALITY
	E3*	HIGH PRESSURE SWITCH (HPS) ACTIVATED
	E5	OL (COMPRESSOR OVERLOAD) STARTED / HIGH PRESSURE SWITCH (HPS) ACTIVATED*
	E6	COMPRESSOR LOCK
	E7	DC FAN LOCK
	F3	DISCHARGE PIPE TEMPERATURE CONTROL
	F6	HIGH PRESSURE CONTROL (IN COOLING)
	H0	COMPRESSOR SYSTEM SENSOR ABNORMALITY
	H6	POSITION SENSOR ABNORMALITY
	H8	DC VOLTAGE / CURRENT SENSOR ABNORMALITY
	H9	OUTDOOR TEMPERATURE THERMISTOR ABNORMALITY
	J3	DISCHARGE PIPE THERMISTOR ABNORMALITY
	J6	OUTDOOR HEAT EXCHANGER THERMISTOR ABNORMALITY
	L3	ELECTRICAL PARTS HEAT FAULT
L4	RADIATION FIN TEMPERATURE RISE	
L5	OUTPUT OVERCURRENT DETECTION	
P4	RADIATION FIN THERMISTOR ABNORMALITY	

*The contents of the error differ depending on the connected outdoor unit.

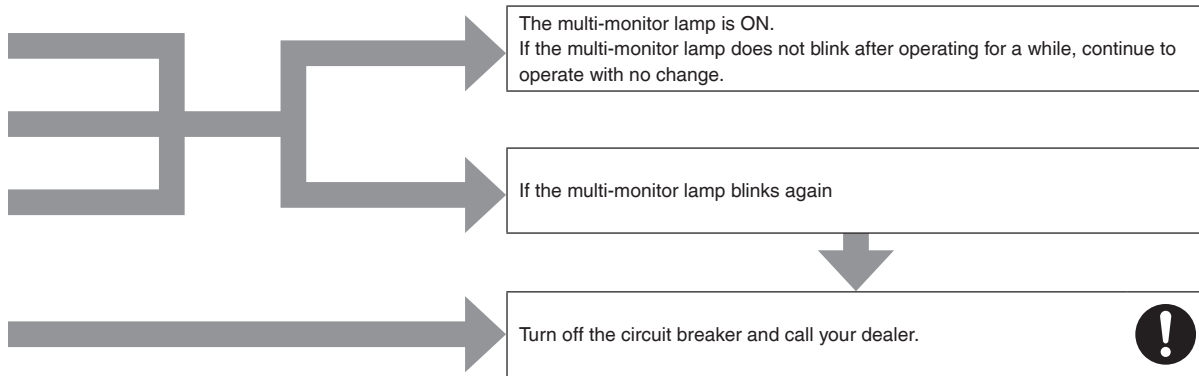

Quick Reference

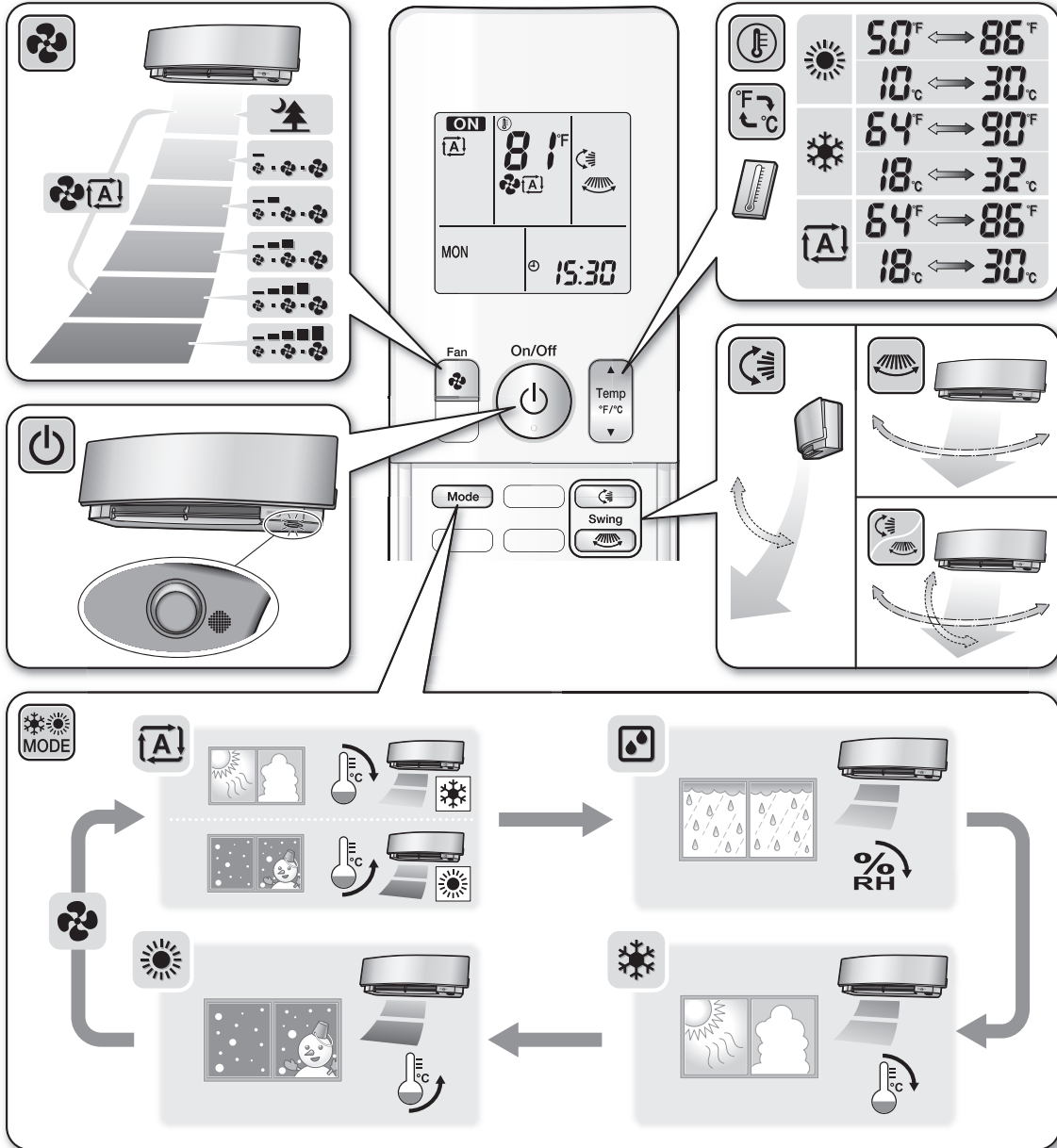

2.3 FVXS

Safety Considerations





Refer also to the General Safety Considerations in the separate booklet.



Read the precautions in this manual carefully before operating the unit.

Read these **Safety Considerations for Operations** carefully before operating an air conditioner or heat pump. Make sure that the unit operates properly during the startup operation. Instruct the user on how to operate and maintain the unit. Inform users that they should store this operation manual with the installation manual for future reference.

Meanings of **DANGER**, **WARNING**, **CAUTION**, and **NOTE** Symbols:

-  **DANGER** Indicates an imminently hazardous situation which, if not avoided, will result in death or serious injury.
-  **WARNING** Indicates a potentially hazardous situation which, if not avoided, could result in death or serious injury.
-  **CAUTION** Indicates a potentially hazardous situation which, if not avoided, may result in minor or moderate injury. It may also be used to alert against unsafe practices.
-  **NOTE** Indicates situations that may result in equipment or property damage accidents only.

DANGER

- Do not install the unit in an area where flammable materials are present due to risk of explosion resulting in serious injury or death.
- Any abnormalities in the operation of the air conditioner or heat pump, such as smoke or fire, could result in severe injury or death. Turn off the power and contact your dealer immediately.
- Refrigerant gas may produce toxic gas if it comes into contact with fire, such as from a fan heater, stove, or cooking device. Exposure to this gas could cause severe injury or death.
- For refrigerant leakage, consult your dealer. Refrigerant gas is heavier than air and replaces oxygen. A massive leak could lead to oxygen depletion, especially in basements, and an asphyxiation hazard could occur leading to serious injury or death.
- If equipment utilizing a burner is used in the same room as the air conditioner or heat pump, there is the danger of oxygen deficiency which could lead to an asphyxiation hazard resulting in serious injury or death. Be sure to ventilate the room sufficiently to avoid this hazard.
- Safely dispose of the packing materials. Packing materials, such as nails and other metal or wooden parts, may cause stabs or other injuries.
- Tear apart and throw away plastic packaging bags so that children will not play with them. Children playing with plastic bags face the danger of death by suffocation.

WARNING

- Contact your dealer for repair and maintenance. Improper repair and maintenance may result in water leakage, electric shock, and fire. Only use accessories made by Daikin that are specifically designed for use with the equipment and have them installed by a professional.
- Contact your dealer to move and reinstall the air conditioner or heat pump. Incomplete installation may result in water leakage, electric shock, and fire.
- Never let the indoor unit or the remote controller get wet. Water can cause an electric shock or a fire.
- Never use flammable spray such as hair spray, lacquer, or paint near the unit. Flammable spray may cause a fire.
- When a fuse blows out, never replace it with one of incorrect ampere ratings or different wires. Always replace any blown fuse with a fuse of the same specification.
- Never remove the fan guard of the unit. A fan rotating at high speed without the fan guard is very dangerous.
- Never inspect or service the unit by yourself. Contact a qualified service person to perform this work.
- Turn off all electrical power before doing any maintenance to avoid the risk of serious electric shock; never sprinkle or spill water or liquids on the unit.
- Do not touch the switch with wet fingers. Touching a switch with wet fingers can cause electric shock.
- Do not allow children to play on or around the unit to prevent injury.
- The heat exchanger fins are sharp enough to cut. To avoid injury wear gloves or cover the fins while working around them.
- Do not put a finger or other objects into the air inlet or air outlet. The fan is rotating at high speed and will cause injury.
- Check the unit foundation for damage on a continuous basis, especially if it has been in use for a long time. If left in a damaged condition the unit may fall and cause injury.
- Placing a flower vase or other containers with water or other liquids on the unit could cause a shock or fire if a spill occurs.
- Do not touch the air outlet or horizontal blades while the swing flap is in operation because fingers could get caught and injured.
- Never touch the internal parts of the controller. Do not remove the front panel because some parts inside are dangerous to touch. To check and adjust internal parts, contact your dealer.
- Do not use means to accelerate the defrosting process or to clean, other than those recommended by the manufacturer.
- The appliance must be stored in a room without continuously operating ignition sources (for example: open flames, an operating gas appliance or an operating electric heater).
- Do not pierce or burn.
- Be aware that refrigerants may not contain an odor.

⚠ CAUTION

- Do not use the air conditioner or heat pump for any other purposes other than comfort cooling or heating. Do not use the unit for cooling precision instruments, food, plants, animals or works of art.
- Do not place items under the indoor unit as they may be damaged by condensates that may form if the humidity is above 80% or if the drain outlet gets blocked.
- Before cleaning, stop the operation of the unit by turning the power off or by pulling the supply cord out from its receptacle. Otherwise, an electric shock and injury may result.
- Do not wash the air conditioner or heat pump with excessive water. An electric shock or fire may result.
- Avoid placing the controller in a spot which may be splashed with water. Water entering the controller may cause an electric shock or damage the internal electronic parts.
- Do not operate the air conditioner or heat pump when using a room-fumigation type of insecticide. Failure to observe this could cause the chemicals to be deposited in the unit and can endanger the health of those who are hypersensitive to chemicals.
- Do not turn off the power immediately after stopping operation. Always wait for at least 5 minutes before turning off the power. Otherwise, water leakage may occur.
- The appliance is not intended for use by young children or infirm persons without supervision.
- The remote controller should be kept away from children so they cannot play with it.
- Consult with the installation contractor for cleaning.
- Incorrect cleaning of the inside of the air conditioner or heat pump could make the plastics parts break and cause water leakage or electric shock.
- Do not touch the air inlet or aluminum fin of the air conditioner or heat pump as they can cut and cause injury.
- Do not place objects in direct proximity of the outdoor unit. Do not let leaves and other debris accumulate around the unit. Leaves are a hotbed for small animals which can enter the unit. Once inside the unit, animals can cause the unit to malfunction, and cause smoke or fire when they make contact with electrical parts.
- Do not wipe the controller operation panel with benzine, thinner, chemical dust cloth, etc. The panel may get discolored or the coating can peel off. If it is heavily dirty, soak a cloth in water-diluted neutral detergent, squeeze it well and wipe the panel clean. Then wipe it with another dry cloth.
- Dismantling of the unit, disposal of the refrigerant, oil, and additional parts, should be done in accordance with the relevant local, state, and national regulations.
- Operate the air conditioner or heat pump in a sufficiently ventilated area and not surrounded by obstacles. Do not use the air conditioner or heat pump in the following places.
 - a. Places with a mist of mineral oil, such as cutting oil.
 - b. Locations such as coastal areas where there is a lot of salt in the air.
 - c. Locations such as hot springs where there is a lot of sulfur in the air.
 - d. Locations such as factories where the power voltage varies a lot.
 - e. In cars, boats, and other vehicles.
 - f. Locations such as kitchens where oil may splatter or where there is steam in the air.
 - g. Locations where equipment produces electromagnetic waves.
 - h. Places with an acid or alkaline mist.
 - i. Places where fallen leaves can accumulate or where weeds can grow.
- Take snow protection measures. Contact your dealer for the details of snow protection measures, such as the use of a snow protection hood.
- Do not attempt to do electrical work or grounding work unless you are licensed to do so. Consult with your dealer for electrical work and grounding work.
- Pay attention to operating sound. Be sure to use the following places:
 - a. Places that can sufficiently withstand the weight of the air conditioner or heat pump yet can suppress the operating sound and vibration.
 - b. Places where warm air from the air outlet of the outdoor unit or the operating sound of the outdoor unit does not annoy neighbors.
- Make sure that there are no obstacles close to the outdoor unit. Obstacles close to the outdoor unit may drop the performance of the outdoor unit or increase the operating sound of the outdoor unit.
- Consult your dealer if the air conditioner or heat pump in operation generates unusual noise.
- Make sure that the drainpipe is installed properly to drain water. If no water is discharged from the drainpipe while the air conditioner or heat pump is in the cooling mode, the drainpipe may be clogged with dust or dirt and water leakage from the indoor unit may occur. Stop operating the air conditioner or heat pump and contact your dealer.
- Do not spray the air conditioner unit with any deodorizers, etc. It may cause the unit to malfunction.

⚠ NOTE

- Never press the button of the remote controller with a hard, pointed object. The remote controller may be damaged.
- Never pull or twist the electric wire of the remote controller. It may cause the unit to malfunction.
- Do not place appliances that produce open flames in places that are exposed to the airflow of the unit or under the indoor unit. It may cause incomplete combustion or deformation of the unit due to the heat.
- Do not expose the controller to direct sunlight. The LCD display can become discolored and may fail to display the data.

FTP002M-U

Names of Parts

Indoor Unit

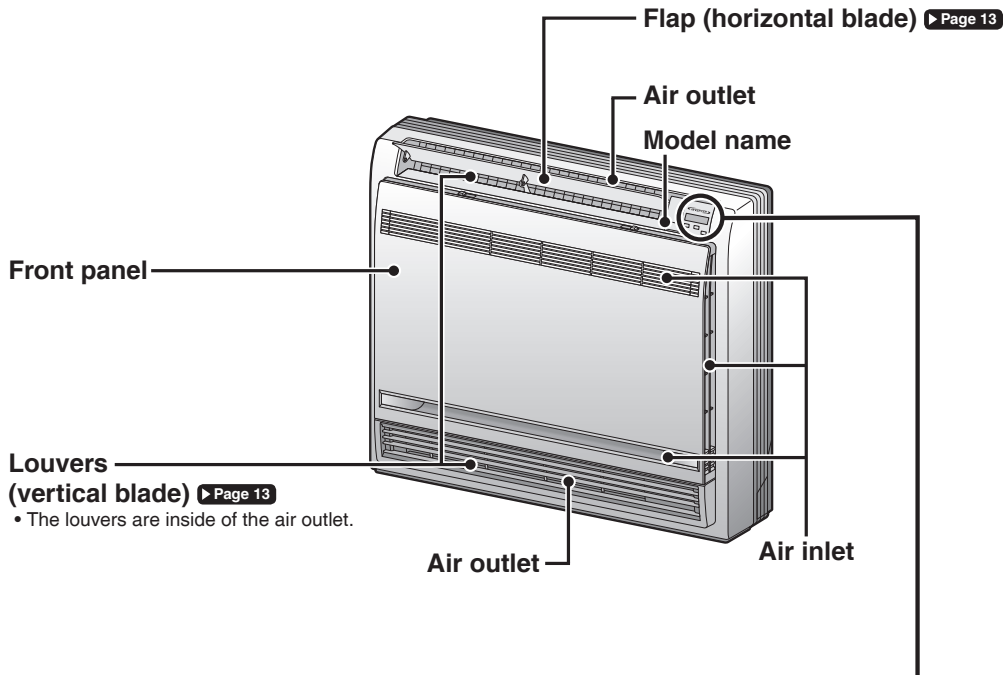

Display

OPERATION lamp (green)

TIMER lamp (orange)
▶ Page 17,18,21,23

ON/OFF

Signal receiver

- Receives signals from the remote controller.
- When the unit receives a signal, you will hear a beep sound.

Case	Sound type
Operation start	beep-beep
Setting changed	beep
Operation stop	long beep

Indoor unit ON/OFF switch

- Press this switch once to start operation. Press once again to stop it.
- For the operation mode setting, refer to the following table.

Mode	Temperature setting	Airflow rate
AUTO	77°F (25°C)	AUTO

- This switch can be used when the remote controller is missing.

■ Open the front panel

- How to open the front panel: ▶ Page 28

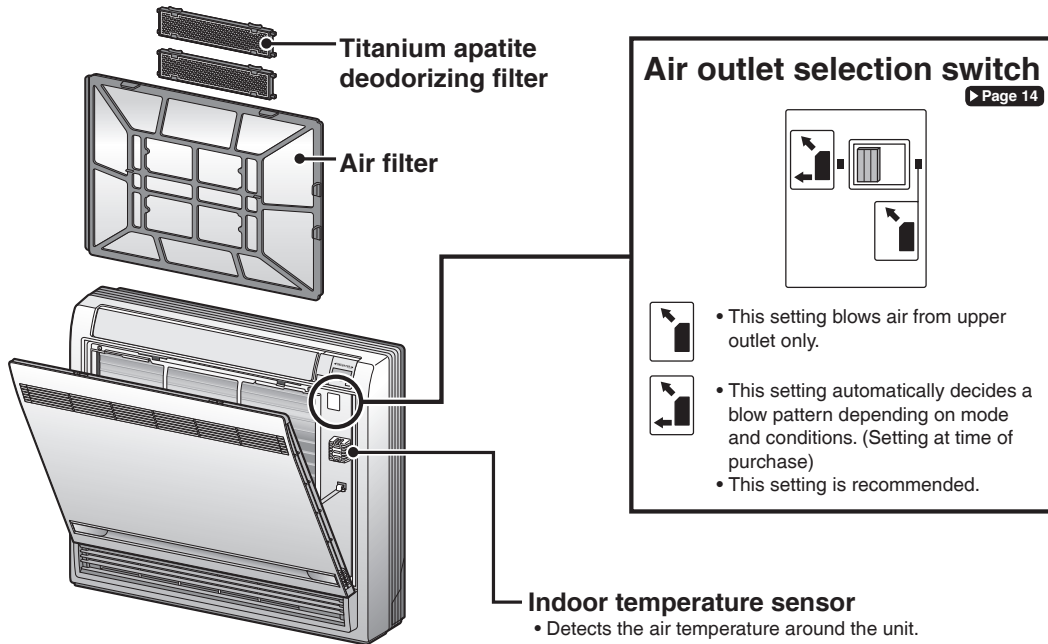

Outdoor Unit

- The appearance of the outdoor unit may differ between different models.

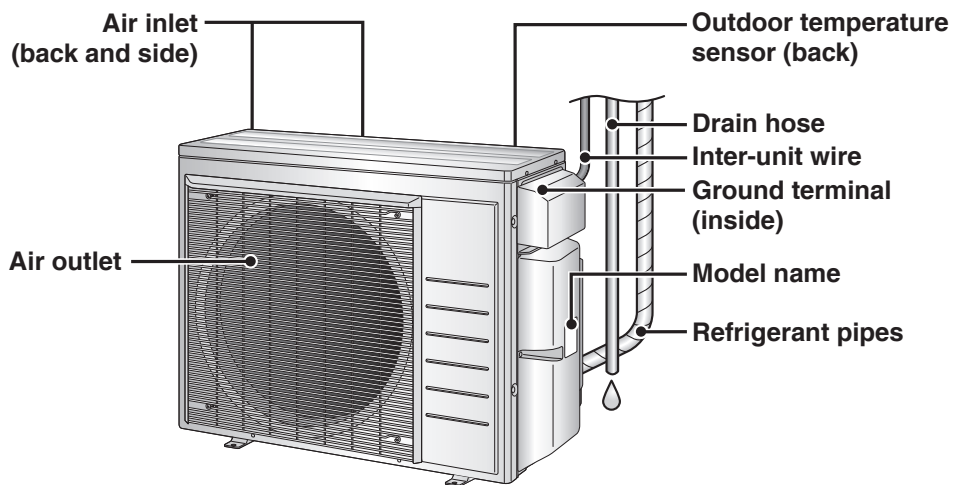

Names of Parts

Remote Controller

Signal transmitter

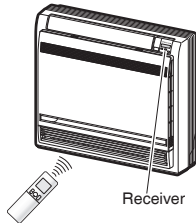

- To use the remote controller, aim the transmitter at the indoor unit. If there is anything blocking the signals between the unit and the remote controller, such as a curtain, the unit may not operate.
- The maximum transmission distance is about 23ft (7m).

Display (LCD)

- Displays the current settings. (In this illustration, each section is shown with all its displays on for the purpose of explanation.)

TEMPERATURE adjustment button

- Changes the temperature setting. [▶ Page 11](#)

ON/OFF button

- Press this button once to start operation. Press once again to stop it. [▶ Page 11](#)

Front cover

- Open the front cover. [▶ Page 8](#)

FAN setting button

- Selects the airflow rate setting. [▶ Page 12](#)

POWERFUL button

- POWERFUL operation. [▶ Page 15](#)

Model	ARC466A21
-------	-----------

■ Open the front cover

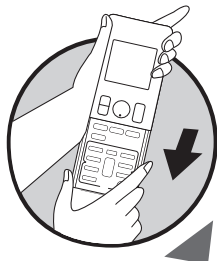

MODE selector button
 • Selects the operation mode.
 (AUTO/DRY/COOL/HEAT/FAN)
 ▶ Page 11

ECONO button
 • ECONO operation. ▶ Page 15

QUIET button
 • QUIET OUTDOOR UNIT operation. ▶ Page 16

SWING button
 • Adjusts the airflow direction. ▶ Page 13

OFF TIMER button (NIGHT SET mode)
 ▶ Page 18

Weekly [] : WEEKLY button
 [] : PROGRAM button
 Copy [] : COPY button
 Back [] : BACK button
 Next [] : NEXT button
 • WEEKLY TIMER operation. ▶ Page 19

TIMER CANCEL button
 • Cancels the timer setting. ▶ Page 17,18
 • Cannot be used for the WEEKLY TIMER operation.

ON TIMER button
 ▶ Page 17

SELECT button
 • Changes the clock, ON/OFF TIMER and WEEKLY TIMER settings.

CLOCK button ▶ Page 10

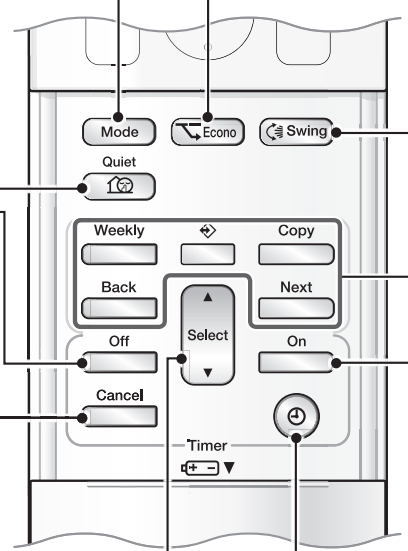

Preparation Before Operation

To insert the batteries

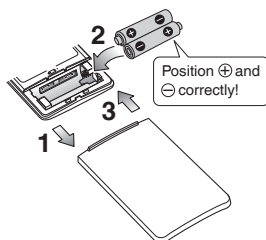

- 1.** Slide the front cover to take it off.
- 2.** Insert 2 dry batteries AAA.LR03 (alkaline).
- 3.** Replace the front cover.

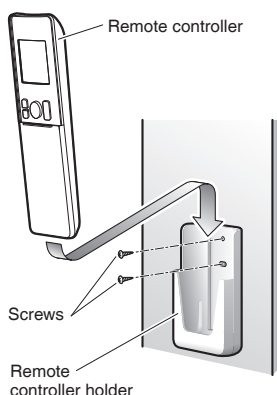

To fix the remote controller holder to a wall

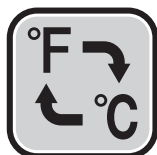

- 1.** Choose a place where the signals reach the unit.
- 2.** Attach the holder to a wall, a pillar, or similar location with the screws supplied with the holder.
- 3.** Place the remote controller in the remote controller holder.

Fahrenheit/Celsius display switch



- Press  and  (TIMER button) simultaneously for about 5 seconds.

- The temperature will be displayed in Celsius when it is presently displayed in Fahrenheit, and vice versa.
- The switch operation is only possible when the temperature is being displayed.

NOTE

Notes on batteries

- When replacing the batteries, use batteries of the same type, and replace both old batteries together.
- The batteries will last for about 1 year. However, if the remote controller display begins to fade and the possible transmission range becomes shorter within a year, replace both batteries with new, size AAA.LR03 (alkaline) batteries.
- The batteries supplied with the remote controller are for initial operation. The batteries may run out in less than 1 year.

Note on remote controller

- Do not drop the remote controller. Do not get it wet.

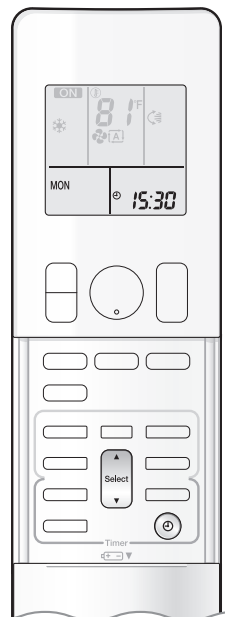

Turn on the circuit breaker

- After the power is turned on, the flaps of the indoor unit open and close once to set the reference position.

To set the clock

1. Press .



“0:00” is displayed on the LCD.
“MON” and “” blink.

2. Press to set the current day of the week.

3. Press .



“” blinks.

4. Press to set the clock to the present time.

- Holding down  or  rapidly increases or decreases the displayed time.

5. Press .

- Point the remote controller at the indoor unit when pressing the buttons.



“.” blinks.

NOTE

Fahrenheit/Celsius display change function of remote controller

- The set temperature may increase when the display is changed to Celsius from Fahrenheit, because a fraction of 0.5°C is rounded up.
- Example: A set temperature of 65°F (equivalent to 18.5°C) will be converted into 19°C.
When the display is changed to Fahrenheit again, the set temperature will be converted into 66°F (equivalent to 19°C) instead of the original set temperature (65°F) but a set temperature of 66°F (equivalent to 19°C) will be converted into 19°C with no temperature change.
- A reception sound will go off for the transmission of set temperature to the indoor unit at the time of setting the Fahrenheit/Celsius display change function.

Note on setting the clock

- If the indoor unit's internal clock is not set to the correct time, the ON/OFF TIMER and WEEKLY TIMER will not operate punctually.



AUTO · DRY · COOL · HEAT · FAN Operation

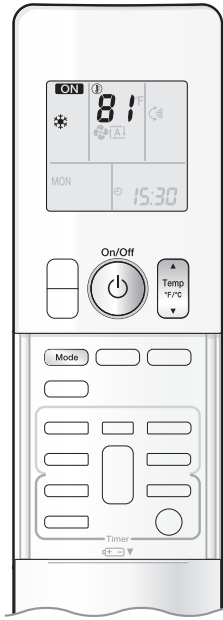

The air conditioner operates with the operation mode of your choice. From the next time on, the air conditioner will operate with the same operation mode.

To start operation

1. Press and select an operation mode.

- Each pressing of the button changes the mode setting in sequence.

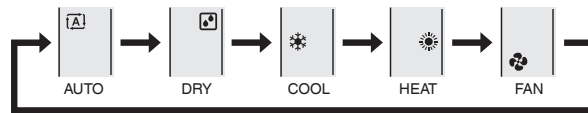

2. Press .

- “**ON**” is displayed on the LCD.
- The OPERATION lamp lights green.

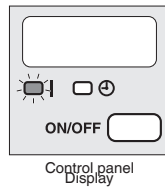

To stop operation

Press again.

- “**ON**” disappears from the LCD.
- The OPERATION lamp goes off.

To change the temperature setting

Press .

- Press ▲ to raise the temperature and press ▼ to lower the temperature.

COOL operation	HEAT operation	AUTO operation	DRY or FAN operation
64-90°F (18-32°C)	50-86°F (10-30°C)	64-86°F (18-30°C)	The temperature setting cannot be changed.

NOTE

Notes on AUTO operation

- In AUTO operation, the system selects an appropriate operation mode (COOL or HEAT) based on the indoor temperature and starts the operation.
- The system automatically reselects setting at a regular interval to bring the indoor temperature to the user-setting level.

Note on DRY operation

- Eliminates humidity while maintaining the indoor temperature as much as possible. It automatically controls temperature and airflow rate, so manual adjustment of these functions is unavailable.



Adjusting the Airflow Rate

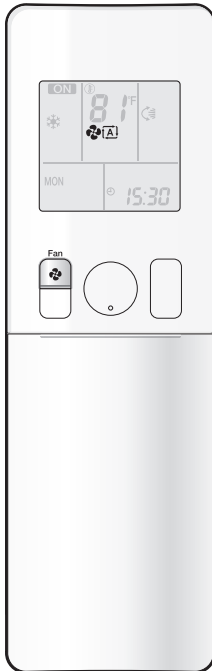

You can adjust the airflow rate to increase your comfort.

To adjust the airflow rate setting

Press .

- Each pressing of changes the airflow rate setting in sequence.

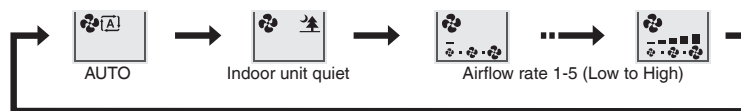

- When the airflow is set to “”, quiet operation starts and noise from the indoor unit will become quieter.
- In the quiet operation mode, the airflow rate is set to a weak level.

AUTO, COOL, HEAT and FAN operation	DRY operation
	<p>The airflow rate setting cannot be changed.</p>

NOTE

Note on airflow rate setting

- At smaller airflow rates, the cooling (heating) effect is also smaller.

Tips for saving energy

Keeping the temperature setting at a moderate level helps save energy.

- Recommended temperature setting
 - For cooling: 78-82°F (26-28°C)
 - For heating: 68-75°F (20-24°C)

Cover windows with a blind or a curtain.

- Blocking sunlight and air from outdoors increases the cooling (heating) effect.

Keep the air filter clean.

- A clogged air filter causes inefficient operation and wastes energy. Clean it once every 2 weeks. [▶ Page 29](#)

If you are not going to use the air conditioner for a long period, for example in spring or autumn, turn off the circuit breaker.

- The air conditioner always consumes a small amount of electricity even while it is not operating.





Adjusting the Airflow Direction

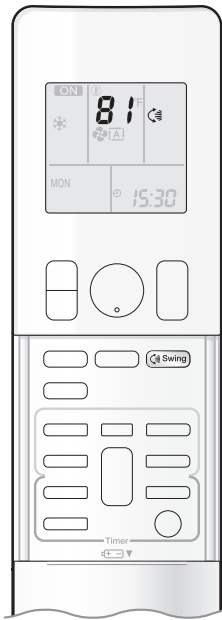

You can adjust the airflow direction to increase your comfort.

CAUTION

- Always use a remote controller to adjust the angles of the flap. Moving the flap forcibly by hand may cause a malfunction.
- Be careful when adjusting the louvers. Inside the air outlet, a fan is rotating at a high speed.

To start auto swing

Up and down airflow direction

Press .

- “” is displayed on the LCD.
- The flaps (horizontal blades) will begin to swing.

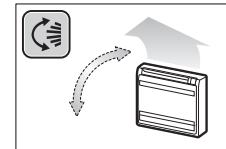

To set the flap at the desired position

- This function is effective while the flap is in auto swing mode.

Press when the flap reaches the desired position.

- “” disappears from the LCD.

To adjust the louvers at desired position

Hold the knobs and move the louvers (vertical blades).

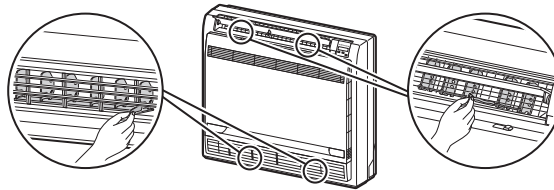

NOTE

Note on airflow direction setting

- The movable range of the flap varies according to the operation mode.
- Unless “Swing” is selected, you should set the flap at a near-horizontal angle in FAN or HEAT operation and at an upward position in COOL or DRY operation to obtain the best performance.

Movable range of the flap

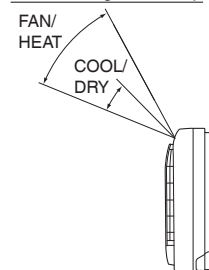







Air outlet selection

- Make air outlet selection according to what suits you. [▶ Page 6](#)

When setting the air outlet selection switch to

- Air conditioner automatically decides the appropriate blowing pattern depending on the operating mode/situation.

Mode	Situation	Blowing pattern	
COOL (❄️)	When the operation is activated or when the room is not fully cooled.		Air is emitted from the upper and lower air outlets in order to reach the set temperature quickly.
	When the room has become fully cool, or when 1 hour has passed since turning on the air conditioner.		Air is emitted only from the upper air outlet so that air does not come into direct contact with people and indoor temperature is equalized.
HEAT (🔥)	When the operation is activated or when air emitted is of low temperature.		Air is emitted only from the upper air outlet so that air does not come into direct contact with people.
	At times other than the above situations.		Air is emitted from the upper and lower air outlets so that warm air is spread throughout the whole room.
DRY (☞)	Whenever in DRY mode.		Air is emitted only from the upper air outlet so that air does not come into direct contact with people.
FAN (🌀)	Whenever in FAN mode.		
AUTO (ⓘ)	Operates in the actual operation mode of the air conditioner according to the descriptions in this table. (COOL or HEAT)		

When setting the air outlet selection switch to

- Regardless of the operating mode or situation, air is emitted from the upper air outlet.
- Use this switch when you do not want air coming out of the lower air outlet. (While sleeping, etc.)



POWERFUL Operation

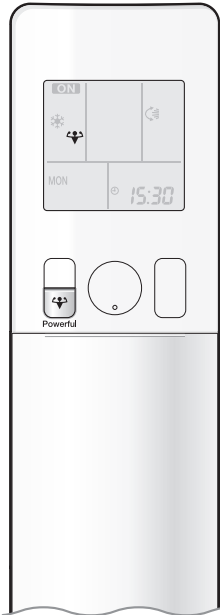

POWERFUL operation quickly maximizes the cooling (heating) effect in any operation mode. In this mode, the air conditioner operates at maximum capacity.

To start POWERFUL operation

Press  during operation.

- “” is displayed on the LCD.
- POWERFUL operation ends in 20 minutes. Then the system automatically operates again with the previous settings which were used before POWERFUL operation.

To cancel POWERFUL operation

Press  again.

- “” disappears from the LCD.



ECONO Operation

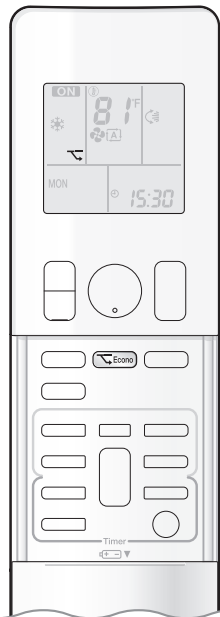

ECONO operation enables efficient operation by limiting the maximum power consumption.

This function is useful to prevent the circuit breaker from tripping when the unit operates alongside other appliances on the same circuit.

To start ECONO operation

Press  during operation.

- “” is displayed on the LCD.
- Not available in FAN ONLY mode.

To cancel ECONO operation

Press  again.

- “” disappears from the LCD.



QUIET OUTDOOR UNIT Operation

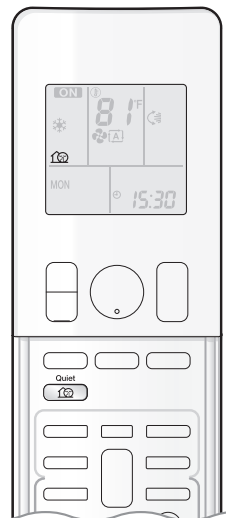

QUIET OUTDOOR UNIT operation lowers the noise level of the outdoor unit by changing the frequency and fan speed of the outdoor unit. This function is convenient during the night-time operation.

To start QUIET OUTDOOR UNIT operation

Press .

- “” is displayed on the LCD.

To cancel QUIET OUTDOOR UNIT operation

Press again.

- “” disappears from the LCD.

NOTE

Notes on POWERFUL operation

- Pressing causes the settings to be canceled, and “” disappears from the LCD.
- POWERFUL operation will not increase the capacity of the air conditioner if the air conditioner is already in operation with its maximum capacity demonstrated.
 - In COOL, HEAT and AUTO operation
To maximize the cooling (heating) effect, the capacity of outdoor unit increases and the airflow rate becomes fixed at the maximum setting. The temperature setting cannot be changed.
 - In DRY operation
The temperature setting is lowered by 4.5°F (2.5°C) and the airflow rate is slightly increased.
 - In FAN ONLY operation
The airflow rate is fixed at the maximum setting.
- When using priority room setting
Refer to “Note for Multi System”. ▶ Page 25

Notes on ECONO operation

- Pressing causes the settings to be canceled, and “” disappears from the LCD.
- If the power consumption level is already low, switching to ECONO operation will not reduce the power consumption.

Notes on QUIET OUTDOOR UNIT operation

- If using a multi system, the QUIET OUTDOOR UNIT operation will work only when this function is set on all operated indoor units. However, if using priority room setting, refer to “Note for Multi System”. ▶ Page 25
- Even if the operation is stopped by using the remote controller or the indoor unit ON/OFF switch when using QUIET OUTDOOR UNIT operation, “” will remain displayed on the remote controller.
- QUIET OUTDOOR UNIT operation will not reduce the frequency nor fan speed if they already are operating at reduced levels.
- This operation is performed with lower power and therefore may not provide a sufficient cooling (heating) effect.

Possible combinations of ECONO / QUIET OUTDOOR UNIT operation and basic operations

	Operation mode				
	AUTO	DRY	COOL	HEAT	FAN
ECONO	✓	✓	✓	✓	—
QUIET OUTDOOR UNIT	✓	—	✓	✓	—

Some useful functions can be used together.

QUIET OUTDOOR UNIT + ECONO	Available
POWERFUL + QUIET OUTDOOR UNIT	Not available*
POWERFUL + ECONO	Not available*

*Priority is given to the function of whichever button is pressed last.



ON/OFF TIMER Operation

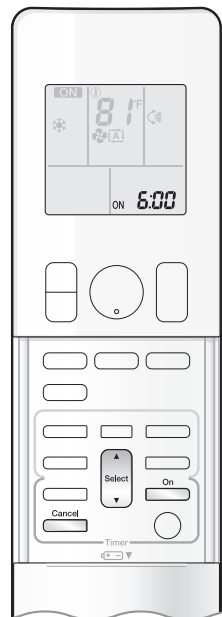

Timer functions are useful for automatically switching the air conditioner on or off at night or in the morning. You can also use the ON TIMER and OFF TIMER together.

To use ON TIMER operation

- Check that the clock is correct.
If not, set the clock to the present time. ▶Page 10

1. Press .

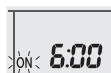

“6:00” is displayed on the LCD.
“ON” blinks.

- “⊕” and day of the week disappear from the LCD.

2. Press until the time setting reaches the point you like.

- Each pressing of either button increases or decreases the time setting by 10 minutes.
Holding down either button changes the setting rapidly.

3. Press again.

- “ON” and setting time are displayed on the LCD.
- The TIMER lamp lights orange.

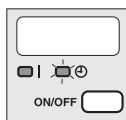

Display

To cancel ON TIMER operation

Press .

- “ON” and setting time disappear from the LCD.
- “⊕” and day of the week are displayed on the LCD.
- The TIMER lamp goes off.

NOTE

Notes on TIMER operation

- When TIMER is set, the present time is not displayed.
- When using the ON/OFF TIMER to start/stop operation, the actual operation start/stop time may differ from the time set. (Maximum of about 10 minutes)

In the following cases, set the timer again.

- After the circuit breaker has turned off.
- After a power failure.
- After replacing the batteries in the remote controller.

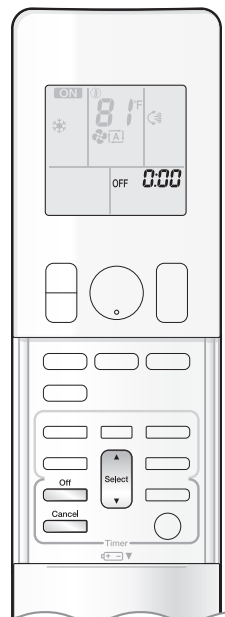

To use OFF TIMER operation

- Check that the clock is correct.
If not, set the clock to the present time. ▶ Page 10

1. Press  .



“ 0:00 ” is displayed on the LCD.
“ OFF ” blinks.

- “ ☉ ” and day of the week disappear from the LCD.

2. Press  until the time setting reaches the point you like.

- Each pressing of either button increases or decreases the time setting by 10 minutes.
Holding down either button changes the time setting rapidly.

3. Press  again.

- “ OFF ” and setting time are displayed on the LCD.
- The TIMER lamp lights orange.

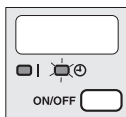

Display

To cancel OFF TIMER operation

Press  .

- “ OFF ” and setting time disappear from the LCD.
- “ ☉ ” and day of the week are displayed on the LCD.
- The TIMER lamp goes off.

To combine ON TIMER and OFF TIMER operation

- A sample setting for combining the 2 timers is shown below.

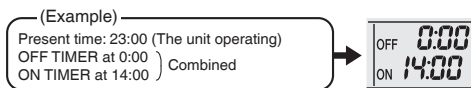

NOTE

NIGHT SET mode

- When the OFF TIMER is set, the air conditioner automatically adjusts the temperature setting (0.9°F (0.5°C) up in COOL, 3.6°F (2.0°C) down in HEAT) to prevent excessive cooling (heating) during sleeping hours.



WEEKLY TIMER Operation

Up to 4 timer settings can be saved for each day of the week. This is convenient to adapt the WEEKLY TIMER to your family's lifestyle.

Setting example of the WEEKLY TIMER

The same timer settings are used from Monday through Friday, while different timer settings are used for the weekend.

<p>[Monday]</p>	<p>Make timer settings for programs 1-4. ▶ Page 20</p>
<p>[Tuesday to Friday]</p>	<p>Use the copy mode to make settings for Tuesday to Friday, because these settings are the same as those for Monday. ▶ Page 22</p>
<p>[Saturday]</p>	<p>No timer settings</p>
<p>[Sunday]</p>	<p>Make timer settings for programs 1-4. ▶ Page 20</p>

- Up to 4 reservations per day and 28 reservations per week can be set using the WEEKLY TIMER. The effective use of the copy mode simplifies timer programming.
- The use of ON-ON-ON-ON settings, for example, makes it possible to schedule operating mode and set temperature changes. Furthermore, by using OFF-OFF-OFF-OFF settings, only the turn off time of each day can be set. This will turn off the air conditioner automatically if you forget to turn it off.

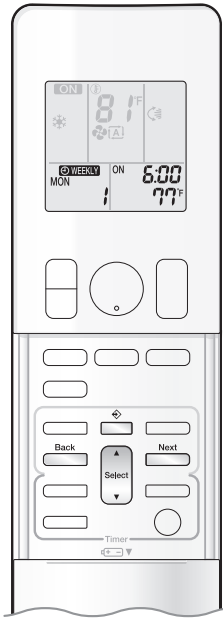

To use WEEKLY TIMER operation

Setting mode

- Make sure the day of the week and time are set.
If not, set the day of the week and time. ▶ [Page 10](#)

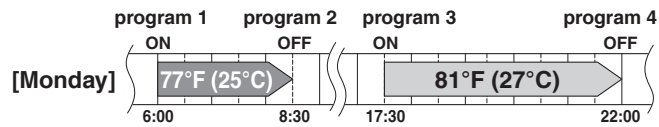

Setting Displays

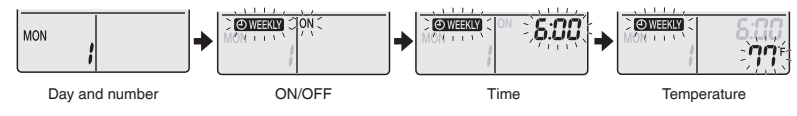

1. Press .

- The day of the week and the reservation number of the current day will be displayed.
- 1 to 4 settings can be made per day.

2. Press to select the desired day of the week and reservation number.

- Pressing  changes the reservation number and the day of the week.

3. Press .

- The day of the week and reservation number will be set.
- “ WEEKLY” and “ON” blink.

4. Press to select the desired mode.

- Pressing  changes the “ON” or “OFF” setting in sequence.



- In case the reservation has already been set, selecting “blank” deletes the reservation.
- Proceed to **STEP 9** if “blank” is selected.
- To return to the day of the week and reservation number setting, press .

5. Press .

- The ON/OFF TIMER mode will be set.
- “ WEEKLY” and the time blink.



WEEKLY TIMER Operation

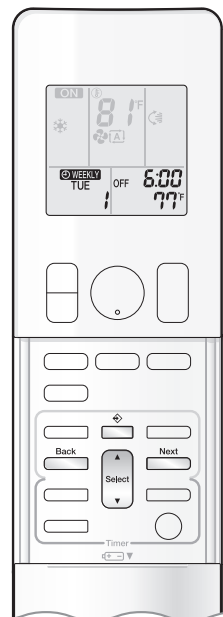

6. Press to select the desired time.

- The time can be set between 0:00 and 23:50 in 10-minute intervals.
- To return to the ON/OFF TIMER mode setting, press  .
- Proceed to **STEP 9** when setting the OFF TIMER.

7. Press .

- The time will be set.
- “ WEEKLY ” and the temperature blink.

8. Press to select the desired temperature.

- The temperature can be set between 50°F (10°C) and 90°F (32°C).
COOL or AUTO: The unit operates at 64°F (18°C) even if it is set at 50°F (10°C) to 63°F (17°C). [▶Page 11](#)
HEAT or AUTO : The unit operates at 86°F (30°C) even if it is set at 87°F (31°C) to 90°F (32°C). [▶Page 11](#)
- To return to the time setting, press  .
- The set temperature is only displayed when the mode setting is on.

9. Press .

- The temperature will be set and go to the next reservation setting.
- The temperature is set while in ON TIMER operation, and the time is set while in OFF TIMER operation.
- The next reservation screen will appear.
- To continue further settings, repeat the procedure from **STEP 4**.

10. Press to complete the setting.

- Be sure to direct the remote controller toward the indoor unit and check for a receiving tone and blinking of the OPERATION lamp.
- “ WEEKLY ” is displayed on the LCD and WEEKLY TIMER operation is activated.
- The TIMER lamp lights orange.

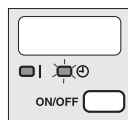



Display

- A reservation made once can be easily copied and the same settings used for another day of the week. Refer to [Copy mode](#) . [▶Page 22](#)

NOTE

Notes on WEEKLY TIMER operation

- Do not forget to set the clock on the remote controller first. [▶Page 10](#)
- The day of the week, ON/OFF TIMER mode, time and set temperature (only for ON TIMER mode) can be set with the WEEKLY TIMER. Other settings for the ON TIMER are based on the settings just before the operation.
- WEEKLY TIMER and ON/OFF TIMER operation cannot be used at the same time. The ON/OFF TIMER operation has priority if it is set while WEEKLY TIMER is still active. The WEEKLY TIMER will enter the standby state, and “ WEEKLY ” will disappear from the LCD. When the ON/OFF TIMER is up, the WEEKLY TIMER will automatically become active.
- Only the time and set temperature with the WEEKLY TIMER are sent with the  . Set the WEEKLY TIMER only after setting the operation mode, the airflow rate and the airflow direction ahead of time.
- Turning off the circuit breaker, power failure, and other similar events will render operation of the indoor unit's internal clock inaccurate. Reset the clock. [▶Page 10](#)
-  can be used only for the time and temperature settings. It cannot be used to go back to the reservation number.

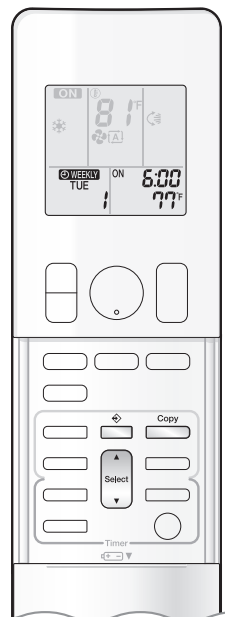

Copy mode

- A reservation made once can be copied to another day of the week. The whole reservation of the selected day of the week will be copied.

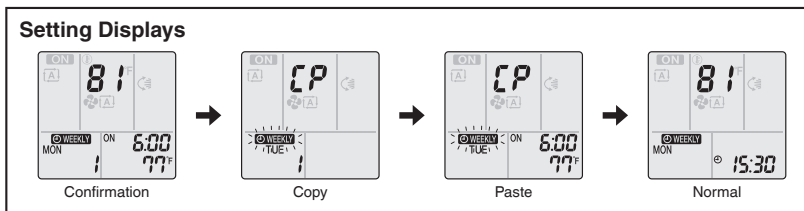
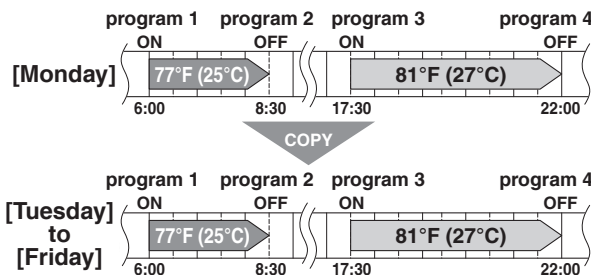

1. Press .
2. Press to confirm the day of the week to be copied.
3. Press .
 - The whole reservation of the selected day of the week will be copied.
4. Press to select the destination day of the week.
5. Press .
 - The reservation will be copied to the selected day of the week. The whole reservation of the selected day of the week will be copied.
 - To continue copying the settings to other days of the week, repeat **STEP 4** and **STEP 5**.
6. Press to complete the setting.
 - “**WEEKLY**” is displayed on the LCD and WEEKLY TIMER operation is activated.

NOTE

Note on COPY MODE

- The entire reservation of the source day of the week is copied in the copy mode.
 In the case of making a reservation change for any day of the week individually after copying the content of weekly reservations, press and change the settings in the steps of **Setting mode** **Page 20**



WEEKLY TIMER Operation

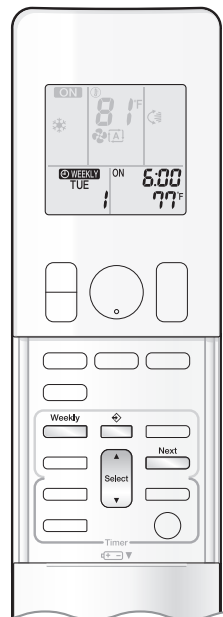

Confirming a reservation

- The reservation can be confirmed.

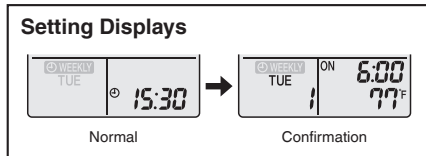

1. Press .

- The day of the week and the reservation number of the current day will be displayed.

2. Press to select the day of the week and the reservation number to be confirmed.

- Pressing displays the reservation details.
- To change the confirmed reserved settings, select the reservation number and press . The mode is switched to setting mode. Proceed to **Setting mode STEP 4.** [▶Page 20](#)

3. Press to exit the confirmation mode.

- “ ” is displayed on the LCD and WEEKLY TIMER operation is activated.
- The TIMER lamp lights orange.

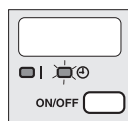

Display

To deactivate WEEKLY TIMER operation

Press while “ ” is displayed on the LCD.

- “ ” disappears from the LCD.
- The TIMER lamp goes off.
- To reactivate the WEEKLY TIMER operation, press again.
- If a reservation deactivated with is activated once again, the last reservation mode will be used.

NOTE

- If not all the reservation settings are reflected, deactivate the WEEKLY TIMER operation once. Then press again to reactivate the WEEKLY TIMER operation.

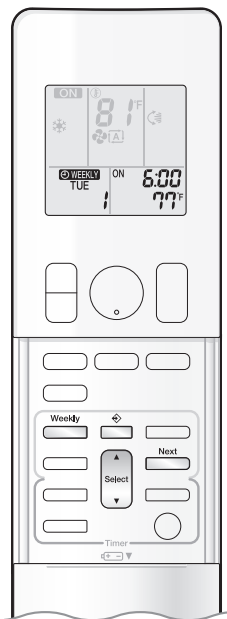

To delete reservations

An individual reservation

- 1. Press** .
 • The day of the week and the reservation number will be displayed.
 - 2. Press** **to select the day of the week and the reservation number to be deleted.**
 - 3. Press** .
 • “ WEEKLY” and “ON” or “OFF” blink.
 - 4. Press** **until no icon is displayed.**
 • Pressing changes the ON/OFF TIMER mode in sequence.
 • Selecting “blank” will cancel any reservation you may have.
- ON TIMER OFF TIMER blank
No Setting
- Pressing puts the sequence in reverse.
- 5. Press** .
 • The selected reservation will be deleted.
 - 6. Press** .
 • If there are still other reservations, WEEKLY TIMER operation will be activated.

Reservations for each day of the week

- This function can be used for deleting reservations for each day of the week.
 - It can be used while confirming or setting reservations.
- 1. Press** .
 • The day of the week and the reservation number will be displayed.
 - 2. Press** **to select the day of the week to be deleted.**
 - 3. Hold** **for about 5 seconds.**
 • The reservation of the selected day of the week will be deleted.
 - 4. Press** .
 • If there are still other reservations, WEEKLY TIMER operation will be activated.

All reservations

- **Hold** **for about 5 seconds with the normal display.**
 - Be sure to direct the remote controller toward the indoor unit and check for a receiving tone.
 - This operation cannot be used for the WEEKLY TIMER setting display.
 - All reservations will be deleted.

Note for Multi System

A multi system has one outdoor unit connected to multiple indoor units.

Selecting the operation mode

When the priority room setting is active but the set unit is not operating or when the priority room setting is inactive

When more than one indoor unit is operating, priority is given to the first unit that was turned on.

In this case, set the units that are turned on later to the same operation mode as the first unit.

Otherwise, they will enter the standby state, and the OPERATION lamp will blink; this does not indicate malfunction.

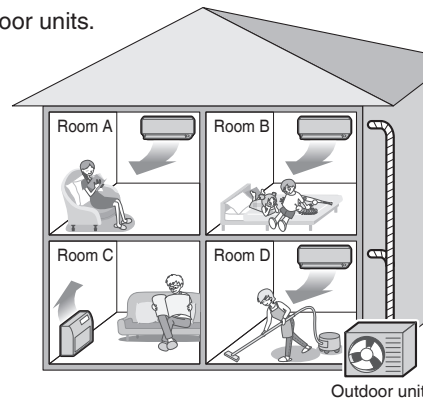

NOTE

Notes on operation mode for a multi system

- COOL, DRY and FAN operation may be used at the same time.
- AUTO operation automatically selects COOL operation or HEAT operation based on the indoor temperature. Therefore, AUTO operation is available when selecting the same operation mode as that of the room with the first unit to be turned on.

CAUTION

- Normally, the operation mode in the room where the unit is first started is given priority, but the following situations are exceptions to this rule. If the operation mode of the first room is FAN operation, then using HEAT operation in any room after this will give priority to HEAT operation. In this situation, the indoor unit operating in FAN mode will switch to standby, and the OPERATION lamp will blink.

With the priority room setting active

Refer to "Priority room setting" on the next page.

NIGHT QUIET operation (Available only for COOL operation)

NIGHT QUIET operation requires initial programming during installation. Please consult your retailer or dealer for assistance. NIGHT QUIET operation reduces the operation noise of the outdoor unit during the night-time hours to prevent annoyance to neighbors.

- NIGHT QUIET operation is activated when the temperature drops 10.8°F (6°C) or more below the highest temperature recorded that day. When the temperature difference between the current outdoor temperature and the maximum outdoor temperature becomes less than 7.2°F (4°C), this function will be canceled.
- NIGHT QUIET operation slightly reduces the cooling efficiency of the unit.

QUIET OUTDOOR UNIT operation

Refer to "QUIET OUTDOOR UNIT Operation". [▶ Page 16](#)

When the priority room setting is active but the set unit is not operating or when the priority room setting is inactive

When using the QUIET OUTDOOR UNIT operation feature with a multi system, set all indoor units to QUIET OUTDOOR UNIT operation using their remote controllers.

When canceling QUIET OUTDOOR UNIT operation, simply cancel the mode on one of the operating indoor units using their remote controller.

However QUIET OUTDOOR UNIT operation will remain displayed on the remote controllers for the other rooms.

We recommend you cancel operation in all rooms using their remote controllers.

With the priority room setting active

Refer to "Priority room setting" on the next page.

COOL/HEAT mode lock

The COOL/HEAT mode lock requires initial programming during installation. Please consult your authorized dealer for assistance. The COOL/HEAT mode lock sets the unit forcibly to either COOL or HEAT operation. This function is convenient when you wish to set all indoor units connected to the multi system to the same operation mode.

NOTE

- The COOL/HEAT mode lock cannot be activated together with the priority room setting.

Priority room setting

The priority room setting requires initial programming during installation. Please consult your authorized dealer for assistance. The room designated as the priority room takes priority in the following situations.

Operation mode priority

- As the operation mode of the priority room takes precedence, you can select a different operation mode from other rooms.

[Example]

- Room A is the priority room in this examples.
When COOL operation is selected in room A while operating the following modes in room B, C and D:

Operation mode in room B, C and D	Status of room B, C and D when the unit in room A is in COOL operation
COOL or DRY or FAN	The current operation mode is maintained.
HEAT	The unit enters the standby mode. Operation resumes when the room A unit stops operating.
AUTO	If the unit is set to COOL operation, it continues. If the unit is set to HEAT operation, it enters the standby mode. Operation resumes when the room A unit stops operating.

Priority when POWERFUL operation is used

[Example]

- Room A is the priority room in this examples.
The indoor units in rooms A, B, C and D are all operating. If the unit in room A enters POWERFUL operation, operation capacity will be concentrated in room A. In such a case, the cooling (heating) efficiency of the units in room B, C and D may be slightly reduced.

Priority when QUIET OUTDOOR UNIT operation is used

[Example]

- Room A is the priority room in this examples.
Just by setting the unit in room A to QUIET operation, the air conditioner starts QUIET OUTDOOR UNIT operation. You do not have to set all the indoor units in operation to QUIET OUTDOOR UNIT operation.

Care and Cleaning

⚠ CAUTION

- Before cleaning, be sure to stop the operation and turn off the circuit breaker.
- Do not touch the aluminum fins of the indoor unit. If you touch those parts, this may cause an injury.

■ Quick reference

Cleaning parts

Air filter

- Vacuum dust or wash the filter.

Once every 2 weeks

▶ Page 29

Front panel

- Wipe it with a soft damp cloth.

If dirty ▶ Page 28

Indoor unit, Outdoor unit and Remote controller

- Wipe them with a soft cloth.

If dirty

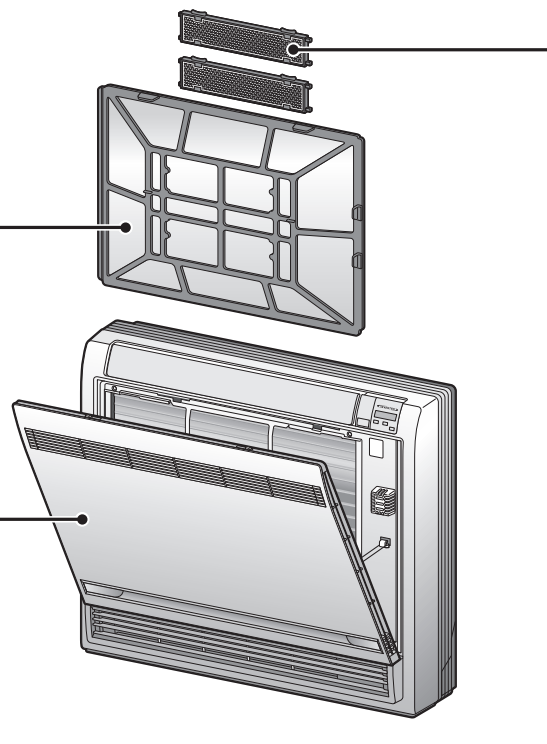

Titanium apatite deodorizing filter

- Vacuum dust or replace the filter.

[Cleaning]
Once every 6 months
▶ Page 30

[Replacement]
Once every 3 years
▶ Page 30

Notes on cleaning

For cleaning, do not use any of the following:

- Water hotter than 104°F (40°C)
- Volatile liquid such as benzene, petrol and thinner
- Polishing compounds
- Rough materials such as a scrubbing brush
- Sprays such as deodorizers



CAUTION

- When removing or attaching the front panel, stand on solid ground and use caution.
- When removing or attaching the front panel, support the panel securely with your hand to prevent it from falling.

■ Front panel

1. Open the front panel.

- Slide the 2 stoppers on the left and right sides inward until they click.

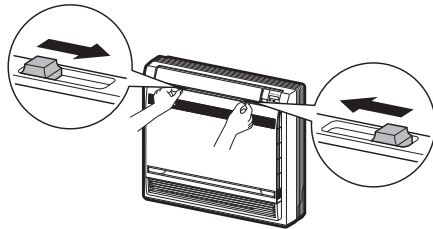

2. Remove the front panel.

- Remove the string.
- Allowing the front panel to fall forward will enable you to remove it.
- Disconnect the front panel hooks from the grooves.

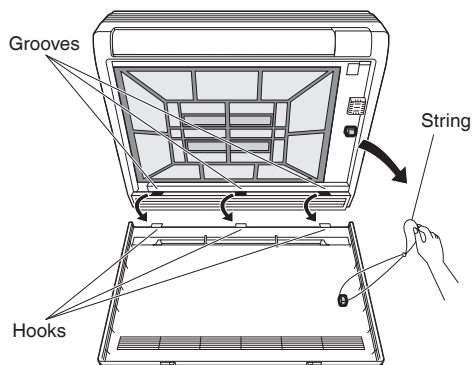

3. Clean the front panel.

- Wipe it with a soft damp cloth.
- Only neutral detergent may be used.
- Wash the panel with water, wipe it with a dry soft cloth, and let it dry in the shade after washing.

4. Reattach the front panel.

- Insert the front panel hooks into the grooves of the unit (3 places).
- Attach the string to the right, inner-side of the front grille.
- Close the panel slowly.

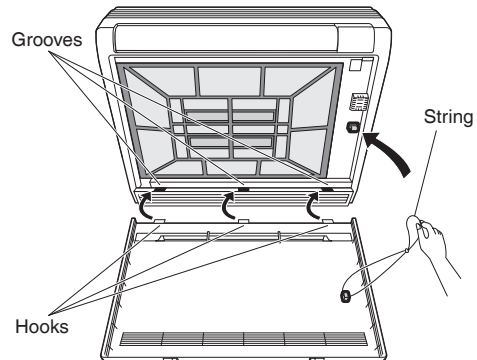

5. Close the front panel slowly.

- Slide the 2 stoppers on the left and right sides outward until they click.

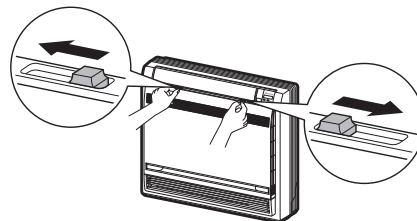

- Make sure that the front panel is securely fixed.

Care and Cleaning

■ Air filter

1. Open the front panel. ▶Page 28

2. Pull out the air filter.

- Press the claws on the right and left of the air filter down slightly, then pull upward.

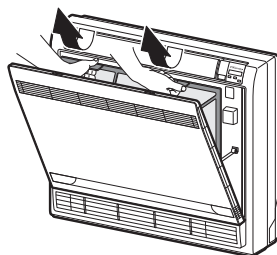

3. Take off the titanium apatite deodorizing filters.

- Hold the recessed parts of the frame and unhook the 4 claws.

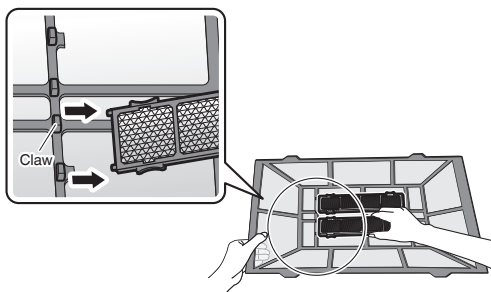

4. Wash the air filter with water or clean it with a vacuum cleaner.

- It is recommended to clean the air filter every 2 weeks.

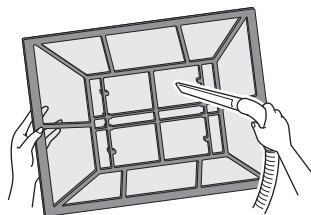

If the dust does not come off easily

- Wash the air filter with neutral detergent thinned with lukewarm water, then let it dry in the shade.
- Be sure to remove the titanium apatite deodorizing filters. Refer to "Titanium apatite deodorizing filter" on the next page.

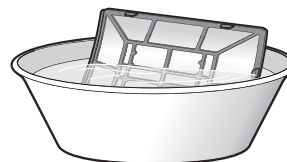

5. Insert the titanium apatite deodorizing filters as they were.

6. Reattach the filters.

7. Close the front panel slowly.

▶Page 28

■ Titanium apatite deodorizing filter

1. Open the front panel and pull out the air filter. ▶ Page 28,29

2. Take off the titanium apatite deodorizing filters.

- Hold the recessed parts of the frame and unhook the 4 claws.

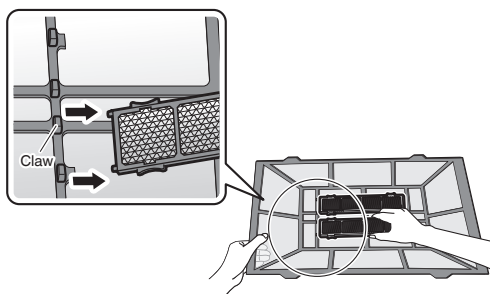

3. Clean or replace the titanium apatite deodorizing filters.

[Cleaning]

3-1 Vacuum dust, and soak in lukewarm water or water for about 10 to 15 minutes if very dirty.

- Do not remove the filter from the frame when washing with water.

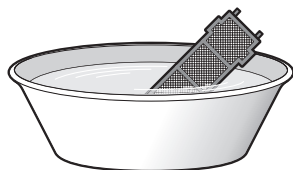

3-2 After washing, shake off remaining water and let them dry in the shade.

- Do not wring out the filter to remove water from it.

[Replacement]

Remove the filter from the filter frame and prepare a new one.

- Do not throw away the filter frame. Reuse the filter frames when replacing the titanium apatite deodorizing filters.

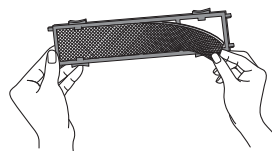

- Dispose of the old filter as non-flammable waste.

4. Insert the titanium apatite deodorizing filters as they were.

- When attaching the filter, check that the filter is properly set in the tabs.

5. Reattach the filters. ▶ Page 29

6. Close the front panel slowly.

▶ Page 28

NOTE

- Operation with dirty filters:
 - cannot deodorize the air,
 - cannot clean the air,
 - results in poor heating or cooling,
 - may cause odor.
- Dispose of old filters as non-flammable waste.
- To order a titanium apatite deodorizing filter, contact the dealer where you bought the air conditioner.

Item	Titanium apatite deodorizing filter (without frame) 1 set
Part No.	KAF968B42

Care and Cleaning

■ Prior to a long period of non-use

1. Operate the FAN mode for several hours to dry out the inside.

1) Press  and select “”.

- When a multi outdoor unit is connected, make sure the HEAT operation is not being used in other rooms before you use the FAN operation. [▶Page 25](#)

2) Press  and start the operation.

2. After operation stops, turn off the circuit breaker for the room air conditioner.

3. Take out the batteries from the remote controller.

■ We recommend periodical maintenance

- In certain operating conditions, the inside of the air conditioner may get foul after several seasons of use, resulting in poor performance. It is recommended to have periodical maintenance by a qualified contractor in addition to regular cleaning by the user.
- For qualified contractor maintenance, please contact the dealer where you bought the air conditioner.

FAQ

Indoor unit

The flap does not start swinging immediately.

- The air conditioner is adjusting the position of the flap. The flap will start moving soon.

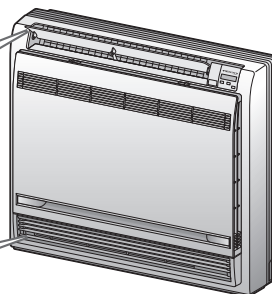

Different sounds are heard.

- **A sound like flowing water**
 - This sound is generated because the refrigerant in the air conditioner is flowing.
 - This is a pumping sound of the water in the air conditioner and can be heard when the water is pumped out from the air conditioner during COOL or DRY operation.
 - The refrigerant flows in the air conditioner even if the air conditioner is not working when the indoor units in other rooms are in operation.
- **Blowing sound**
 - This sound is generated when the flow of the refrigerant in the air conditioner is switched over.
- **Ticking sound**
 - This sound is generated when the cabinet and frame of the air conditioner slightly expand or shrink as a result of temperature changes.
- **Whistling sound**
 - This sound is generated when refrigerant flows during defrosting operation.
- **Clicking sound during operation or idle time**
 - This sound is generated when the refrigerant control valves or the electrical parts operate.
- **Clopping sound**
 - This sound is heard from the inside of the air conditioner when the exhaust fan is activated while the room doors are closed. Open the window or turn off the exhaust fan.

The air conditioner stops generating airflow during HEAT operation.

- Once the set temperature is reached, the airflow rate is reduced and operation stopped in order to avoid generating a cool airflow. Operation will resume automatically when the indoor temperature falls.

HEAT operation stops suddenly and a flowing sound is heard.

- The outdoor unit is defrosting. HEAT operation starts after the frost on the outdoor unit has been removed. This can take about 4 to 12 minutes.

Operation does not start soon.

- When  was pressed soon after operation was stopped.
- When the mode was reselected.
 - This is to protect the air conditioner. You should wait for about 3 minutes.

Outdoor unit

Operating sound is loud.

- When frost forms on the heat exchanger of the outdoor unit, the operating sound level increases slightly.

The outdoor unit emits water or steam.

- **In HEAT operation**
 - The frost on the outdoor unit melts into water or steam when the air conditioner is in defrosting operation.
- **In COOL or DRY operation**
 - Moisture in the air condenses into water on the cool surface of the outdoor unit piping and drips.

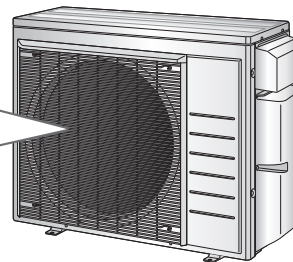

Troubleshooting

Before making an inquiry or a request for repair, please check the following.
If the problem persists, consult your dealer.



Not a problem

This case is not a problem.



Check

Please check again before requesting repairs.

The air conditioner does not operate

Case	Description / what to check
OPERATION lamp is off.	<ul style="list-style-type: none"> Has the circuit breaker been tripped or the fuse blown? Is there a power failure? Are batteries set in the remote controller?
OPERATION lamp is blinking.	<ul style="list-style-type: none"> Check the error code and consult your dealer. ▶ Page 36

The air conditioner suddenly stops operating

Case	Description / what to check
OPERATION lamp is on.	<ul style="list-style-type: none"> To protect the system, the air conditioner may stop operating after sudden large voltage fluctuations. It automatically resumes operation in about 3 minutes.
OPERATION lamp is blinking.	<ul style="list-style-type: none"> Is there anything blocking the air inlet or air outlet of the indoor unit or outdoor unit? Stop operation and after turning off the circuit breaker, remove the obstruction. Then restart operation with the remote controller. If the OPERATION lamp is still blinking, check the error code and consult your dealer. ▶ Page 36 Are operation modes all the same for indoor units connected to outdoor units in the multi system? If not, set all indoor units to the same operation mode and confirm that the lamps. Moreover, when the operation mode is in AUTO, set all indoor unit operation modes to COOL or HEAT for a moment and check again that the lamps are normal. If the lamps stop blinking after the above steps, there is no malfunction. ▶ Page 25

The air conditioner does not stop operating

Case	Description / what to check
The air conditioner continues operating even after operation is stopped.	<ul style="list-style-type: none"> Immediately after the air conditioner is stopped <ul style="list-style-type: none"> The outdoor unit fan continues rotating for about another 1 minute to protect the system. While the air conditioner is not in operation <ul style="list-style-type: none"> When the outdoor temperature is high, the outdoor unit fan may start rotating to protect the system.

The room does not cool down / warm up

Case	Description / what to check
Air does not come out.	<ul style="list-style-type: none"> In HEAT operation <ul style="list-style-type: none"> The air conditioner is warming up. Wait for about 1 to 4 minutes. During defrosting operation, hot air does not flow out of the indoor unit. When the air conditioner operates immediately after the circuit breaker is turned on <ul style="list-style-type: none"> The air conditioner is preparing to operate. Wait for about 3 to 20 minutes.
Air does not come out / Air comes out.	<ul style="list-style-type: none"> Is the airflow rate setting appropriate? <ul style="list-style-type: none"> Is the airflow rate setting low, such as "Indoor unit quiet" or "Airflow rate 1"? Increase the airflow rate setting. Is the set temperature appropriate? Is the adjustment of the airflow direction appropriate?
Air comes out.	<ul style="list-style-type: none"> Is there any furniture directly under or beside the indoor unit? Is the air conditioner in ECONO operation or QUIET OUTDOOR UNIT operation? ▶ Page 15,16 Is the air filter dirty? Is there anything blocking the air inlet or air outlet of the indoor unit or outdoor unit? Is a window or door open? Is an exhaust fan turning?

Mist comes out

Case	Description / what to check
Mist comes out of the indoor unit.	<input checked="" type="checkbox"/> • This happens when the air in the room is cooled into mist by the cold airflow during COOL or other operation.

Remote controller

Case	Description / what to check
The unit does not receive signals from the remote controller or has a limited operating range.	<input checked="" type="checkbox"/> • The batteries may be exhausted. Replace both batteries with new dry batteries AAA.LR03 (alkaline). For details, refer to "Preparation Before Operation". ▶ Page 9 • Signal communication may be disabled if an electronic-starter-type fluorescent lamp (such as inverter-type lamps) is in the room. Consult your dealer if that is the case. • The remote controller may not function correctly if the transmitter is exposed to direct sunlight.
LCD is faint, is not working, or the display is erratic.	<input checked="" type="checkbox"/> • The batteries may be exhausted. Replace both batteries with new dry batteries AAA.LR03 (alkaline). For details, refer to "Preparation Before Operation". ▶ Page 9
Other electric devices start operating.	<input checked="" type="checkbox"/> • If the remote controller activates other electric devices, move them away or consult your dealer.

Air has an odor

Case	Description / what to check
The air conditioner gives off an odor.	<input checked="" type="checkbox"/> • The room odor absorbed in the unit is discharged with the airflow. We recommend you to have the indoor unit cleaned. Please consult your dealer.

Others

Case	Description / what to check
The air conditioner suddenly starts behaving strangely during operation.	<input type="checkbox"/> • The air conditioner may malfunction due to lightning or radio. If the air conditioner malfunctions, turn off the power with the circuit breaker and restart the operation with the remote controller.
HEAT operation cannot be selected, even though the unit is heat pump model.	<input type="checkbox"/> • Check that the jumper (J8) has not been cut. If it has been cut, contact your dealer.
The ON/OFF TIMER does not operate according to the settings.	<input checked="" type="checkbox"/> • Check if the ON/OFF TIMER and the WEEKLY TIMER are set to the same time. Change or deactivate the settings in the WEEKLY TIMER. ▶ Page 19



Notes on the operating conditions

- If operation continues under any conditions other than those listed in the table,
 - A safety device may activate to stop the operation. (With a multi connection in COOL operation, the safety device may work to stop the operation of the outdoor unit only.)
 - Dew may form on the indoor unit and drip from it when COOL or DRY operation is selected.
- *1 Cutting the jumper on the outdoor unit PCB will extend the cooling operation range to 14°F (–10.0°C). Installing an air direction adjustment grille (sold separately) will further extend the operation range to –4°F (–20.0°C). Please consult your dealer.
- *2 Installing a drain pan heater (sold separately) will further extend the heating operation range to –13°F (–25.0°C). Please consult your dealer.

Mode	Operating conditions
COOL / DRY	Outdoor temperature: [MXS, MXL, MXLH models]: 14 - 115°F (–10 - 46°C) [RXL models]: 50 ¹ - 115°F (10 ¹ - 46°C) *1 –4°F (–20°C) If an air direction adjustment grille (sold separately) is installed.
	Indoor temperature: : 64 - 90°F (18 - 32°C)
	Indoor humidity: : 80% max.
HEAT	Outdoor temperature: [MXS models]: : 5 - 75°F (–15 - 24°C) [MXL models]: : 5 ² - 75°F (–15 ² - 24°C) [MXLH models]: : –13 - 75°F (–25 - 24°C) [RXL models]: : 5 ² - 75°F (–15 ² - 24°C) *2 –13°F (–25°C) If a drain pan heater (sold separately) is installed.
	Indoor temperature: : 50 - 86°F (10 - 30°C)

Troubleshooting

The OPERATION lamp blinks

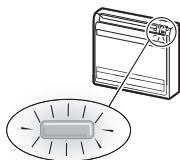

■ Check the interval time between blinks of the OPERATION lamp.

■ If connecting to multiple indoor units

[Blink interval of about 2 to 3 seconds]

Check the operation mode of any indoor units connected in other rooms. Because this is a multi system air conditioner, it has one outdoor unit connected to multiple indoor units in different rooms.

If the operation mode is different from the operation mode of the indoor unit in another room, the OPERATION lamp may blink and operation may not be performed, or operation may stop while in progress.

COOL, DRY and HEAT operation may not be used at the same time.

[Blink interval of about 0.5 seconds]

This is a notification of an abnormality.

Check the error code following the procedure below, and respond according to the instructions in the table.



■ Fault diagnosis by remote controller



1. When is held down for about 5 seconds, “00” blinks in the temperature display section.

2. While pointing the remote controller at the indoor unit, press repeatedly.

A beep indicates a non-corresponding error code
A long beep indicates a corresponding error code

3. When a long beep is produced, check the error code and respond according to the instructions in the table.

- To cancel the code display, hold down for about 5 seconds (the code display also clears if no button is pressed for a while).

CODE	Cause	Description / what to check
E7	The fan of the outdoor unit is stopped. • Is there any foreign matter inside the outdoor unit?	After turning off the circuit breaker, remove the foreign matter, then turn the power on again and operate.
L3, L4, L5	The temperature inside the outdoor unit has become too high, so operation has stopped. • Is there anything blocking the air outlet of the outdoor unit?	After turning off the circuit breaker, remove the obstruction, then turn the power on again and operate.
Other error codes, or if the error code cannot be checked		An abnormality has occurred.

In the case of error code U0 or F3

	CODE	MEANING
SYSTEM	00	NORMAL
	UA	INDOOR-OUTDOOR UNIT COMBINATION FAULT
	U0	REFRIGERANT SHORTAGE
	U2	DROP VOLTAGE OR MAIN CIRCUIT OVERVOLTAGE
	U4	FAILURE OF TRANSMISSION (BETWEEN INDOOR UNIT AND OUTDOOR UNIT)
INDOOR UNIT	A1	INDOOR PCB DEFECTIVENESS
	A5	HIGH PRESSURE CONTROL OR FREEZE-UP PROTECTOR
	A6	FAN MOTOR FAULT
	C4	FAULTY HEAT EXCHANGER TEMPERATURE SENSOR
	C9	FAULTY SUCTION AIR TEMPERATURE SENSOR
OUTDOOR UNIT	EA	COOLING-HEATING SWITCHING ERROR
	E1	CIRCUIT BOARD FAULT
	E3*	HIGH PRESSURE SWITCH (HPS) ACTIVATED
	E5	OL (COMPRESSOR OVERLOAD) STARTED / HIGH PRESSURE SWITCH (HPS) ACTIVATED*
	E6	FAULTY COMPRESSOR START UP
	E7	DC FAN MOTOR FAULT
	F3	HIGH TEMPERATURE DISCHARGE PIPE CONTROL
	F6	HIGH PRESSURE CONTROL (IN COOLING)
	H0	SENSOR FAULT
	H6	OPERATION HALT DUE TO FAULTY POSITION DETECTION SENSOR
	H8	DC CURRENT SENSOR FAULT
	H9	FAULTY SUCTION AIR TEMPERATURE SENSOR
	J3	FAULTY DISCHARGE PIPE TEMPERATURE SENSOR
	J6	FAULTY HEAT EXCHANGER TEMPERATURE SENSOR
	L3	ELECTRICAL PARTS HEAT FAULT
L4	HIGH TEMPERATURE AT INVERTER CIRCUIT HEATSINK	
L5	OUTPUT OVERCURRENT	
P4	FAULTY INVERTER CIRCUIT HEATSINK TEMPERATURE SENSOR	

*The contents of the error differ depending on the connected outdoor unit.

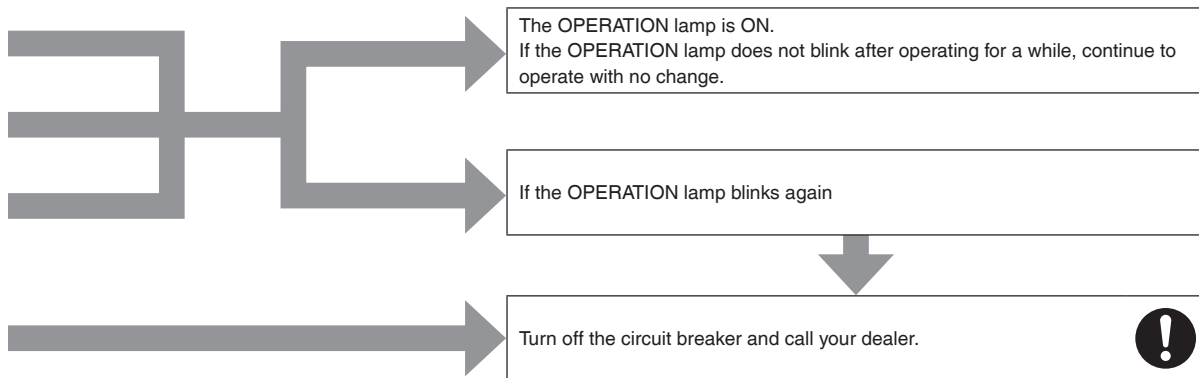

Troubleshooting

■ Call your dealer immediately

WARNING

When an abnormality (such as a burning smell) occurs, stop operation and turn off the circuit breaker.

- Continued operation in an abnormal condition may result in problems, electric shock or fire.
- Consult the dealer where you bought the air conditioner.

Do not attempt to repair or modify the air conditioner by yourself.

- Incorrect work may result in electric shock or fire.
- Consult the dealer where you bought the air conditioner.

If one of the following symptoms takes place, call your dealer immediately.

- The power cord is abnormally hot or damaged.
- An abnormal sound is heard during operation.
- The circuit breaker, a fuse, or the ground fault circuit interrupter cuts off the operation frequently.
- A switch or a button often fails to work properly.
- There is a burning smell.
- Water leaks from the indoor unit.

Turn off the circuit breaker and call your dealer.



■ After a power failure

- The air conditioner automatically resumes operation in about 3 minutes. You should just wait for a while.

■ Lightning

- If there is a risk lightning could strike in the neighborhood, stop operation and turn off the circuit breaker to protect the system.

■ Disposal requirements

- Dismantling of the unit, handling of the refrigerant, oil and other parts, should be done in accordance with the relevant local and national regulations.

Quick Reference

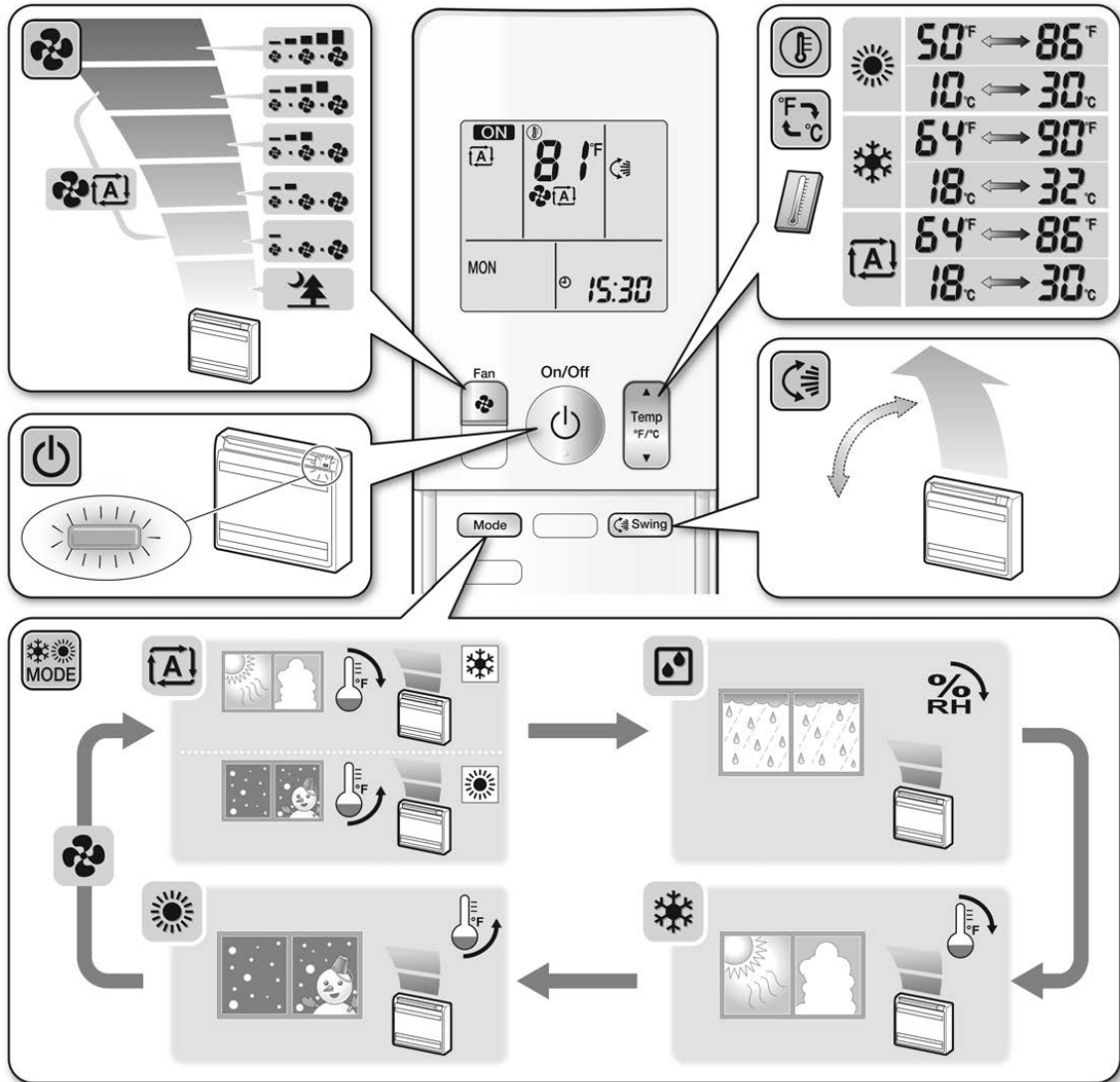

2.4 CDMQ, FDMQ

Contents

■ Read Before Operation

Safety Considerations..... 1
 Names of Parts 4

■ Multi Connection

Note for Multi System 5

■ Care

Care and Cleaning 7

■ When the Need Arises

Troubleshooting 9

The pictures in this document are for illustrative purposes only.

Safety Considerations

Refer also to the General Safety Considerations in the separate booklet.



Read the precautions in this manual carefully before operating the unit.

Read these **Safety Considerations for Operations** carefully before operating an air conditioner or heat pump. Make sure that the unit operates properly during the startup operation. Instruct the user on how to operate and maintain the unit. Inform users that they should store this operation manual with the installation manual for future reference. Meanings of **DANGER**, **WARNING**, **CAUTION**, and **NOTE** Symbols:

- ⚠ DANGER** Indicates an imminently hazardous situation which, if not avoided, will result in death or serious injury.
- ⚠ WARNING** Indicates a potentially hazardous situation which, if not avoided, could result in death or serious injury.
- ⚠ CAUTION** Indicates a potentially hazardous situation which, if not avoided, may result in minor or moderate injury. It may also be used to alert against unsafe practices.
- ⚠ NOTE** Indicates situations that may result in equipment or property damage accidents only.

— ⚠ DANGER —

- Do not install the unit in an area where flammable materials are present due to risk of explosion resulting in serious injury or death.
- Any abnormalities in the operation of the air conditioner or heat pump, such as smoke or fire, could result in severe injury or death. Turn off the power and contact your dealer immediately.
- Refrigerant gas may produce toxic gas if it comes into contact with fire, such as from a fan heater, stove, or cooking device. Exposure to this gas could cause severe injury or death.
- For refrigerant leakage, consult your dealer. Refrigerant gas is heavier than air and replaces oxygen. A massive leak could lead to oxygen depletion, especially in basements, and an asphyxiation hazard could occur leading to serious injury or death.
- If equipment utilizing a burner is used in the same room as the air conditioner or heat pump, there is the danger of oxygen deficiency which could lead to an asphyxiation hazard resulting in serious injury or death. Be sure to ventilate the room sufficiently to avoid this hazard.
- Safely dispose of the packing materials. Packing materials, such as nails and other metal or wooden parts, may cause stabs or other injuries.
- Tear apart and throw away plastic packaging bags so that children will not play with them. Children playing with plastic bags face the danger of death by suffocation.

⚠ WARNING

- Contact your dealer for repair and maintenance. Improper repair and maintenance may result in water leakage, electric shock, and fire. Only use accessories made by Daikin that are specifically designed for use with the equipment and have them installed by a professional.
- Contact your dealer to move and reinstall the air conditioner or heat pump. Incomplete installation may result in water leakage, electric shock, and fire.
- Never let the indoor unit or the remote controller get wet. Water can cause an electric shock or a fire.
- Never use flammable spray such as hair spray, lacquer, or paint near the unit. Flammable spray may cause a fire.
- When a fuse blows out, never replace it with one of incorrect ampere ratings or different wires. Always replace any blown fuse with a fuse of the same specification.
- Never remove the fan guard of the unit. A fan rotating at high speed without the fan guard is very dangerous.
- Never inspect or service the unit by yourself. Contact a qualified service person to perform this work.
- Turn off all electrical power before doing any maintenance to avoid the risk of serious electric shock; never sprinkle or spill water or liquids on the unit.
- Do not touch the switch with wet fingers. Touching a switch with wet fingers can cause electric shock.
- Do not allow children to play on or around the unit to prevent injury.
- The heat exchanger fins are sharp enough to cut. To avoid injury wear gloves or cover the fins while working around them.
- Do not put a finger or other objects into the air inlet or air outlet. The fan is rotating at high speed and will cause injury.
- Check the unit foundation for damage on a continuous basis, especially if it has been in use for a long time. If left in a damaged condition the unit may fall and cause injury.
- Do not touch the air outlet or horizontal blades while the swing flap is in operation because fingers could get caught and injured.
- Never touch the internal parts of the controller. Do not remove the front panel because some parts inside are dangerous to touch. To check and adjust internal parts, contact your dealer.
- Do not use means to accelerate the defrosting process or to clean, other than those recommended by the manufacturer.
- The appliance must be stored in a room without continuously operating ignition sources (for example: open flames, an operating gas appliance or an operating electric heater).
- Do not pierce or burn.
- Be aware that refrigerants may not contain an odor.

⚠ CAUTION

- Do not use the air conditioner or heat pump for any other purposes other than comfort cooling or heating. Do not use the unit for cooling precision instruments, food, plants, animals or works of art.
- Do not place items under the indoor unit as they may be damaged by condensates that may form if the humidity is above 80% or if the drain outlet gets blocked.
- Before cleaning, stop the operation of the unit by turning the power off or by pulling the supply cord out from its receptacle. Otherwise, an electric shock and injury may result.
- Do not wash the air conditioner or heat pump with excessive water. An electric shock or fire may result.
- Avoid placing the controller in a spot which may be splashed with water. Water entering the controller may cause an electric shock or damage the internal electronic parts.
- Do not operate the air conditioner or heat pump when using a room-fumigation type of insecticide. Failure to observe this could cause the chemicals to be deposited in the unit and can endanger the health of those who are hypersensitive to chemicals.
- Do not turn off the power immediately after stopping operation. Always wait for at least 5 minutes before turning off the power. Otherwise, water leakage may occur.
- The appliance is not intended for use by young children or infirm persons without supervision.
- The remote controller should be kept away from children so they cannot play with it.
- Consult with the installation contractor for cleaning.
- Incorrect cleaning of the inside of the air conditioner or heat pump could make the plastics parts break and cause water leakage or electric shock.
- Do not touch the air inlet or aluminum fin of the air conditioner or heat pump as they can cut and cause injury.
- Do not place objects in direct proximity of the outdoor unit. Do not let leaves and other debris accumulate around the unit. Leaves are a hotbed for small animals which can enter the unit. Once inside the unit, animals can cause the unit to malfunction, and cause smoke or fire when they make contact with electrical parts.

Safety Considerations

— NOTE —

- Never press the button of the remote controller with a hard, pointed object. The remote controller may be damaged.
- Never pull or twist the electric wire of the remote controller. It may cause the unit to malfunction.
- Do not place appliances that produce open flames in places that are exposed to the airflow of the unit or under the indoor unit. It may cause incomplete combustion or deformation of the unit due to the heat.
- Do not expose the controller to direct sunlight. The LCD display can become discolored and may fail to display the data.
- Do not wipe the controller operation panel with benzine, thinner, chemical dust cloth, etc. The panel may get discolored or the coating can peel off. If it is heavily dirty, soak a cloth in water-diluted neutral detergent, squeeze it well and wipe the panel clean. Then wipe it with another dry cloth.
- Dismantling of the unit, disposal of the refrigerant, oil, and additional parts, should be done in accordance with the relevant local, state, and national regulations.
- Operate the air conditioner or heat pump in a sufficiently ventilated area and not surrounded by obstacles. Do not use the air conditioner or heat pump in the following places.
 - a. Places with a mist of mineral oil, such as cutting oil.
 - b. Locations such as coastal areas where there is a lot of salt in the air.
 - c. Locations such as hot springs where there is a lot of sulfur in the air.
 - d. Locations such as factories where the power voltage varies a lot.
 - e. In cars, boats, and other vehicles.
 - f. Locations such as kitchens where oil may splatter or where there is steam in the air.
 - g. Locations where equipment produces electromagnetic waves.
 - h. Places with an acid or alkaline mist.
 - i. Places where fallen leaves can accumulate or where weeds can grow.
- Take snow protection measures. Contact your dealer for the details of snow protection measures, such as the use of a snow protection hood.
- Do not attempt to do electrical work or grounding work unless you are licensed to do so. Consult with your dealer for electrical work and grounding work.
- Pay attention to operating sound. Be sure to use the following places:
 - a. Places that can sufficiently withstand the weight of the air conditioner or heat pump yet can suppress the operating sound and vibration.
 - b. Places where warm air from the air outlet of the outdoor unit or the operating sound of the outdoor unit does not annoy neighbors.
- Make sure that there are no obstacles close to the outdoor unit. Obstacles close to the outdoor unit may drop the performance of the outdoor unit or increase the operating sound of the outdoor unit.
- Consult your dealer if the air conditioner or heat pump in operation generates unusual noise.
- Make sure that the drainpipe is installed properly to drain water. If no water is discharged from the drainpipe while the air conditioner or heat pump is in the cooling mode, the drainpipe may be clogged with dust or dirt and water leakage from the indoor unit may occur. Stop operating the air conditioner or heat pump and contact your dealer.
- Do not spray the air conditioner unit with any deodorizers, etc. It may cause the unit to malfunction.

FFP002M-U

This is an appliance that is not accessible to the general public.

Names of Parts

Indoor Unit

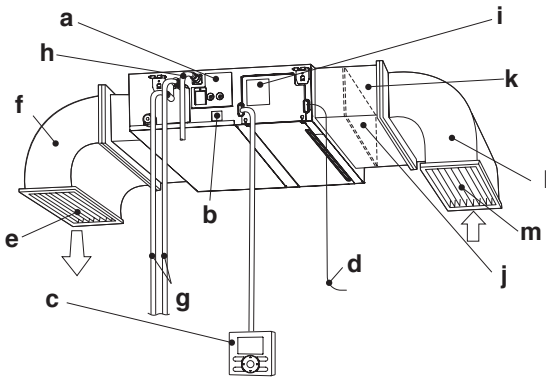

a	Drain discharge device (built-in)	g	Refrigerant piping
b	Drain pan inspection window	h	Drain piping
c	Remote controller (Wired type) The appearance of the remote controller may differ between different models.	i	Model name (Model name plate)
d	Wiring between the indoor and outdoor units	j	Air filter (Sold separately)
e	Air outlet grille (Field supply)	k	Suction filter chamber (Sold separately)
f	Exhaust duct (Field supply)	l	Suction duct (Field supply)
		m	Suction grille (Field supply)

Remote controller

Wired type

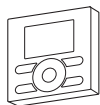

Wireless type

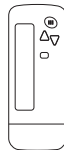

• For details on remote controller operation, refer to the operation manual included with the remote controller.

Outdoor Unit

• The appearance of the outdoor unit may differ between different models.

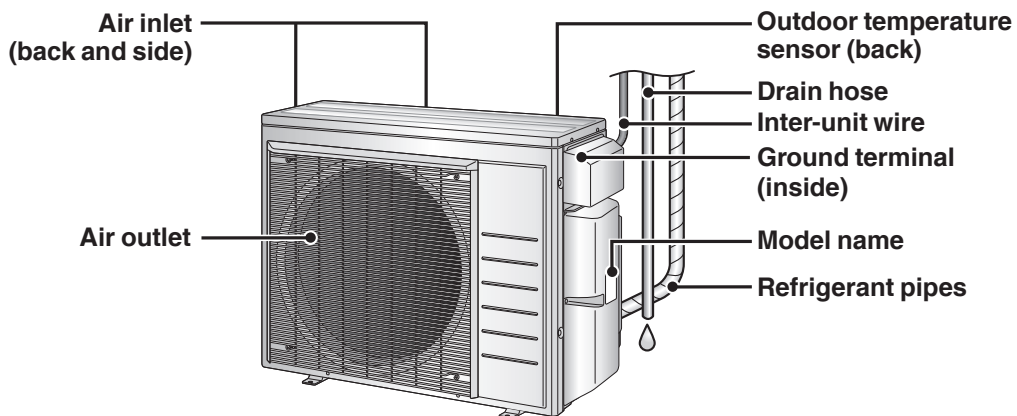

Note for Multi System

A multi system has one outdoor unit connected to multiple indoor units.

Selecting the operation mode

When the priority room setting is active but the set unit is not operating or when the priority room setting is inactive

When more than one indoor unit is operating, priority is given to the first unit that was turned on.

In this case, set the units that are turned on later to the same operation mode as the first unit.

Otherwise, they will enter the standby state, and when using the wired remote controller the centralized control icon "CENTRAL CONTROL" will light up; this does not indicate malfunction.

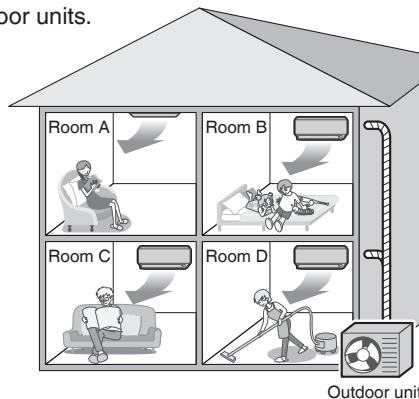

NOTE

Notes on operation mode for a multi system

- COOL, DRY and FAN operation may be used at the same time.
- AUTO operation automatically selects COOL operation or HEAT operation based on the indoor temperature. Therefore, AUTO operation is available when selecting the same operation mode as that of the room with the first unit to be turned on.

CAUTION

- Normally, the operation mode in the room where the unit is first started is given priority, but the following situations are exceptions to this rule. If the operation mode of the first room is FAN operation, then using HEAT operation in any room after this will give priority to HEAT operation. In this situation, the indoor unit operating in FAN mode will switch to standby, and when using the wired remote controller the centralized control icon "CENTRAL CONTROL" will light up.

With the priority room setting active

Refer to "Priority room setting" on the next page.

NIGHT QUIET mode (Available only for COOL operation)

NIGHT QUIET mode requires initial programming during installation. Please consult your retailer or dealer for assistance.

NIGHT QUIET mode reduces the operation noise of the outdoor unit during the night-time hours to prevent annoyance to neighbours.

- NIGHT QUIET mode is activated when the temperature drops 10.8°F (6°C) or more below the highest temperature recorded that day. When the temperature difference between the current outdoor temperature and the maximum outdoor temperature becomes less than 7.2°F (4°C), this function will be canceled.
- NIGHT QUIET mode slightly reduces the cooling efficiency of the unit.

QUIET OUTDOOR UNIT operation (Function unavailable in the FDMQ series)

For details on QUIET OUTDOOR UNIT operation, refer to the operation manual included with the remote controller.

When the priority room setting is active but the set unit is not operating or when the priority room setting is inactive

When using the QUIET OUTDOOR UNIT operation feature with a multi system, set all indoor units to QUIET OUTDOOR UNIT operation using their remote controllers.

When canceling QUIET OUTDOOR UNIT operation, simply cancel the mode on one of the operating indoor units using their remote controller.

However QUIET OUTDOOR UNIT operation will remain displayed on the remote controllers for the other rooms.

We recommend you cancel operation in all rooms using their remote controllers.

With the priority room setting active

Refer to "Priority room setting" on the next page.

COOL/HEAT mode lock

The COOL/HEAT mode lock requires initial programming during installation. Please consult your authorized dealer for assistance. The COOL/HEAT mode lock sets the unit forcibly to either COOL or HEAT operation. This function is convenient when you wish to set all indoor units connected to the multi system to the same operation mode.

NOTE

- The COOL/HEAT mode lock cannot be activated together with the priority room setting.

Priority room setting

The priority room setting requires initial programming during installation. Please consult your authorized dealer for assistance. The room designated as the priority room takes priority in the following situations.

Operation mode priority

- As the operation mode of the priority room takes precedence, you can select a different operation mode from other rooms.

[Example]

- Room A is the priority room in this example.
When COOL operation is selected in room A while operating the following modes in room B, C and D:

Operation mode in room B, C and D	Status of room B, C and D when the unit in room A is in COOL operation
COOL or DRY or FAN	The current operation mode is maintained.
HEAT	The unit enters the standby mode. Operation resumes when the room A unit stops operating.
AUTO	If the unit is set to COOL operation, it continues. If the unit is set to HEAT operation, it enters the standby mode. Operation resumes when the room A unit stops operating.

Priority when QUIET OUTDOOR UNIT operation is used (Function unavailable in the FDMQ series)

[Example]

- Room A is the priority room in this example.
Just by setting the unit in room A to QUIET operation, the air conditioner starts QUIET OUTDOOR UNIT operation.
You do not have to set all the indoor units in operation to QUIET OUTDOOR UNIT operation.

Priority when POWERFUL operation is used (Function unavailable in the FDMQ series)

[Example]

- Room A is the priority room in this example.
The indoor units in rooms A, B, C and D are all operating. If the unit in room A enters POWERFUL operation, operation capacity will be concentrated in room A. In such a case, the cooling (heating) efficiency of the units in room B, C and D may be slightly reduced.

Care and Cleaning

WARNING

- Only a qualified service person is allowed to perform maintenance.
- Before cleaning, be sure to stop unit operation and turn off the circuit breaker.
Otherwise, an electric shock and injury may result.
- Contact a qualified person regarding the attachment of accessories and be sure to use only accessories specified by the manufacturer.
If an accessory is attached incorrectly, water leakage, an electric shock, or fire may result.

CAUTION

- When cleaning, use a sturdy and stable stand and watch your step.
- Do not touch the aluminium fins of the indoor unit. If you touch those parts, this may cause an injury.

■ How to clean the air filter

When the remote controller indicates "Time to clean filter", clean the air filter.

- It indicates after running for a certain time.

Notes on cleaning

For cleaning, do not use any of the following:

- Water hotter than 104°F (40°C)
- Volatile liquid such as benzene, gasoline and thinner
- Polishing compounds or liquid insecticide
- Rough materials such as a scrubbing brush
- Sprays such as deodorizers
- You may change the time of indication "Time to clean filter".



If the indoor unit is used in a space where the air is too contaminated, ask your local dealer for solution.

Contamination	Time until indication is displayed
Normal	2500 hours (equivalent to one year)
More contaminated	1250 hours (equivalent to a half year)

- If it becomes difficult to remove contamination from the air filter, replace the air filter.
(Air filter for replacement is a separately sold accessory.)
- Do not remove the air filter except when cleaning. Unnecessary handling may damage the filter.
(This product is not provided with an air filter as a standard accessory.)
- Do not attach objects other than the genuine air filter (e.g., kitchen paper) to the air inlet.
Otherwise, the performance of the air conditioner will be degraded, and icing or water leakage may result.
- This product is a ceiling mounted duct type air conditioner.

Installing under roof

If the air filter (sold separately) is used, request a special contractor for the cleaning of the air filter.

Not installing under roof

Always use the long-life filter chamber (sold separately). Be sure to request your dealer for the installation of the long-life chamber. For the methods of mounting, dismantling, and cleaning the air filter, refer to the manual provided with the air filter.

- Be sure to use the separately sold filter chamber.
Request your dealer for the installation of the filter chamber.
- Be sure to clean the air filter at the beginning of the cooling or heating season.
(A decrease in the airflow volume of the air conditioner will result and the performance of the air conditioner will be degraded if the air filter is clogged with dust or dirt.)

Increase the frequency of cleaning if the unit is installed in a room where the air is extremely contaminated.

After completing cleaning and installing an air filter, turn off the indication of "Time to clean filter" on the remote controller.

- For details, refer to the operation manual attached to the remote controller.
- The indication can be turned off while the unit is either operating or stopped.

■ How to clean air outlet, outside panels and remote controller

- 1. Clean with soft cloth.**
- 2. When it is difficult to remove stains, use water or neutral detergent.**

NOTE

- Do not wash the suction grille with water of 122°F (50°C) or higher. It may cause discoloration and deformation.
- When drying the suction grille, do not heat it with fire. It may cause burning.
- Do not use substances such as gasoline, benzene, thinner, polishing powder and liquid insecticide sold in the market. It may cause discoloration and deformation.

■ Prior to a long period of non-use

- 1. Operate the FAN mode for several hours on a fine day to dry out the inside.**

- 1) Press the "MODE" selector button and select "FAN" operation.
 - When a multi outdoor unit is connected, make sure the HEAT operation is not being used in other rooms before you use the FAN operation. ▶ **Page 5**
- 2) Press the "ON/OFF" button and start operation.

- 2. After operation stops, turn off the circuit breaker for the room air conditioner.**

- 3. Clean the air filters and reattach them.** ▶ **Page 7**

- 4. To prevent battery leakage, take out the batteries from the remote controller. (Only for the wireless remote controller)**

■ We recommend periodical maintenance

- In certain operating conditions, the inside of the air conditioner may get foul after several seasons of use, resulting in poor performance. It is recommended to have periodical maintenance by a specialist.
- For specialist maintenance, please contact the dealer where you bought the air conditioner.
- The maintenance cost must be borne by the user.

Troubleshooting

Before making an inquiry or a request for repair, please check the following.
If the problem persists, consult your dealer.



Not a problem

This case is not a problem.



Check

Please check again before requesting repairs.

Case	Description / what to check
Operation does not start soon. <ul style="list-style-type: none"> When ON/OFF button was pressed soon after operation was stopped. When the mode was reselected. 	<input checked="" type="checkbox"/> <ul style="list-style-type: none"> This is to protect the air conditioner. You should wait for about 3 minutes.
Air does not come out.	<input checked="" type="checkbox"/> <ul style="list-style-type: none"> In HEAT operation <ul style="list-style-type: none"> The air conditioner is warming up. Wait for about 1 to 4 minutes. During defrosting operation, hot air does not flow out of the indoor unit. When the air conditioner operates immediately after the circuit breaker is turned on <ul style="list-style-type: none"> The air conditioner is preparing to operate. Wait for about 3 to 20 minutes.
The HEAT operation stops suddenly and a flowing sound is heard.	<input checked="" type="checkbox"/> <ul style="list-style-type: none"> The system is taking away the frost on the outdoor unit. You should wait for about 4 to 12 minutes.
The outdoor unit emits water or steam.	<input checked="" type="checkbox"/> <ul style="list-style-type: none"> In HEAT mode <ul style="list-style-type: none"> The frost on the outdoor unit melts into water or steam when the air conditioner is in defrost operation. In COOL or DRY mode <ul style="list-style-type: none"> Moisture in the air condenses into water on the cool surface of outdoor unit piping and drips.
Mist comes out of the indoor unit.	<input checked="" type="checkbox"/> <ul style="list-style-type: none"> This happens when the air in the room is cooled into mist by the cold airflow during cooling operation.
The indoor unit gives out odor.	<input checked="" type="checkbox"/> <ul style="list-style-type: none"> This happens when smells of the room, furniture, or cigarettes are absorbed into the unit and discharged with the airflow. (If this happens, we recommend you to have the indoor unit washed by a technician. Consult your dealer where you bought the air conditioner.)
The outdoor fan rotates while the air conditioner is not in operation.	<input checked="" type="checkbox"/> <ul style="list-style-type: none"> After operation is stopped: <ul style="list-style-type: none"> The outdoor fan continues rotating for another 1 minute for system protection. While the air conditioner is not in operation: <ul style="list-style-type: none"> When the outdoor temperature is very high, the outdoor fan starts rotating for system protection.
The operation stopped suddenly. (OPERATION lamp* is on.)	<input checked="" type="checkbox"/> <ul style="list-style-type: none"> For system protection, the air conditioner may stop operating on a sudden large voltage fluctuation. It automatically resumes operation in about 3 minutes. Are operation modes all the same for indoor units connected to outdoor units in the multi system? If not, set all indoor units to the same operation mode.
The air conditioner does not operate. (OPERATION lamp* is off.)	<input type="checkbox"/> <ul style="list-style-type: none"> Hasn't the circuit breaker turned OFF or a fuse blown? Isn't it a power failure? Are batteries set in the remote controller? Is the timer setting correct?
Cooling (Heating) effect is poor.	<input type="checkbox"/> <ul style="list-style-type: none"> Are the air filters clean? Is there anything blocking the air inlet or the outlet of the indoor and the outdoor units? Is the temperature setting appropriate? Are the windows and doors closed? Are the airflow rate set appropriately?
Operation stops suddenly. (OPERATION lamp* is blinking.)	<input type="checkbox"/> <ul style="list-style-type: none"> Are the air filters clean? Is there anything blocking the air inlet or the outlet of the indoor and the outdoor units? Clean the air filters or take all obstacles away and turn the circuit breaker OFF. Then turn it ON again and try operating the air conditioner with the remote controller. If the lamp still blinks, call your dealer where you bought the air conditioner.

* The OPERATION lamp is on the receiver of the separately sold wireless remote controller or wired remote controller.

Case	Description / what to check
An abnormal functioning happens during operation.	 • The air conditioner may malfunction with lightning or radio waves. Turn the breaker OFF, turn it ON again and try operating the air conditioner with the remote controller.

Notes on the operating conditions

- If operation continues under any conditions other than those listed in the table,
 - A safety device may activate to stop the operation. (With a multi connection in COOL operation, the safety device may work to stop the operation of the outdoor unit only.)
 - Dew may form on the indoor unit and drip from it when COOL or DRY operation is selected.
- *1 Cutting the jumper on the outdoor unit PCB will extend the cooling operation range to 14°F (-10.0°C). Installing an air direction adjustment grille (sold separately) will further extend the operation range to -4°F (-20.0°C). Please consult your dealer.
- *2 Installing a drain pan heater (sold separately) will further extend the heating operation range to -13°F (-25.0°C). Please consult your dealer.

Mode	Operating conditions
COOL / DRY	Outdoor temperature: [MXS, MXL, MXLH models] : 14 - 115°F (-10 - 46°C) [RX, RXL models] : 50*1 - 115°F (10*1 - 46°C) *1 -4°F (-20°C) If an air direction adjustment grille (sold separately) is installed.
	Indoor temperature : 64 - 90°F (18 - 32°C) Indoor humidity : 80% max.
HEAT	Outdoor temperature: [MXS models] : 5 - 75°F (-15 - 24°C) [MXL models] : 5*2 - 75°F (-15*2 - 24°C) [MXLH models] : -13 - 75°F (-25 - 24°C) [RX models] : 5 - 75°F (-15 - 24°C) [RXL models] : 5*2 - 75°F (-15*2 - 24°C) *2 -13°F (-25°C) If a drain pan heater (sold separately) is installed.
	Indoor temperature : 50 - 86°F (10 - 30°C)

■ Call your dealer immediately

 **WARNING**

When an abnormality (such as a burning smell) occurs, stop operation and turn off the circuit breaker.

- Continued operation in an abnormal condition may result in problems, electric shock or fire.
- Consult the dealer where you bought the air conditioner.

Do not attempt to repair or modify the air conditioner by yourself.

- Incorrect work may result in electric shock or fire.
- Consult the dealer where you bought the air conditioner.

If one of the following symptoms takes place, call your dealer immediately.

- The power cord is abnormally hot or damaged.
- An abnormal sound is heard during operation.
- The circuit breaker cuts off the operation frequently.
- A switch or a button often fails to work properly.
- There is a burning smell.
- Water leaks from the indoor unit.

Turn off the circuit breaker and call your dealer.



■ After a power failure

- The air conditioner automatically resumes operation in about 3 minutes. You should just wait for a while.

■ Lightning

- If there is a risk lightning could strike in the neighborhood, stop operation and turn off the circuit breaker to protect the system.

■ Disposal requirements

- Dismantling of the unit, handling of the refrigerant, oil and other parts, should be done in accordance with the relevant local and national regulations.

2.5 FFQ

Contents

■ Read Before Operation

Safety Considerations..... 1
 Names of Parts 4

■ Multi Connection

Note for Multi System 5

■ Care

Care and Cleaning 7
 Troubleshooting 11

The pictures in this document are for illustrative purposes only.

Safety Considerations





Refer also to the General Safety Considerations in the separate booklet.



Read the precautions in this manual carefully before operating the unit.

Read these **Safety Considerations for Operations** carefully before operating an air conditioner or heat pump. Make sure that the unit operates properly during the startup operation. Instruct the user on how to operate and maintain the unit. Inform users that they should store this operation manual with the installation manual for future reference.

Meanings of **DANGER**, **WARNING**, **CAUTION**, and **NOTE** Symbols:

-  **DANGER** Indicates an imminently hazardous situation which, if not avoided, will result in death or serious injury.
-  **WARNING** Indicates a potentially hazardous situation which, if not avoided, could result in death or serious injury.
-  **CAUTION** Indicates a potentially hazardous situation which, if not avoided, may result in minor or moderate injury. It may also be used to alert against unsafe practices.
-  **NOTE** Indicates situations that may result in equipment or property damage accidents only.

— **DANGER** —

- Do not install the unit in an area where flammable materials are present due to risk of explosion resulting in serious injury or death.
- Any abnormalities in the operation of the air conditioner or heat pump, such as smoke or fire, could result in severe injury or death. Turn off the power and contact your dealer immediately.
- Refrigerant gas may produce toxic gas if it comes into contact with fire, such as from a fan heater, stove, or cooking device. Exposure to this gas could cause severe injury or death.
- For refrigerant leakage, consult your dealer. Refrigerant gas is heavier than air and replaces oxygen. A massive leak could lead to oxygen depletion, especially in basements, and an asphyxiation hazard could occur leading to serious injury or death.
- If equipment utilizing a burner is used in the same room as the air conditioner or heat pump, there is the danger of oxygen deficiency which could lead to an asphyxiation hazard resulting in serious injury or death. Be sure to ventilate the room sufficiently to avoid this hazard.
- Safely dispose of the packing materials. Packing materials, such as nails and other metal or wooden parts, may cause stabs or other injuries.
- Tear apart and throw away plastic packaging bags so that children will not play with them. Children playing with plastic bags face the danger of death by suffocation.

⚠ WARNING

- Contact your dealer for repair and maintenance. Improper repair and maintenance may result in water leakage, electric shock, and fire. Only use accessories made by Daikin that are specifically designed for use with the equipment and have them installed by a professional.
- Contact your dealer to move and reinstall the air conditioner or heat pump. Incomplete installation may result in water leakage, electric shock, and fire.
- Never let the indoor unit or the remote controller get wet. Water can cause an electric shock or a fire.
- Never use flammable spray such as hair spray, lacquer, or paint near the unit. Flammable spray may cause a fire.
- When a fuse blows out, never replace it with one of incorrect ampere ratings or different wires. Always replace any blown fuse with a fuse of the same specification.
- Never remove the fan guard of the unit. A fan rotating at high speed without the fan guard is very dangerous.
- Never inspect or service the unit by yourself. Contact a qualified service person to perform this work.
- Turn off all electrical power before doing any maintenance to avoid the risk of serious electric shock; never sprinkle or spill water or liquids on the unit.
- Do not touch the switch with wet fingers. Touching a switch with wet fingers can cause electric shock.
- Do not allow children to play on or around the unit to prevent injury.
- The heat exchanger fins are sharp enough to cut. To avoid injury wear gloves or cover the fins while working around them.
- Do not put a finger or other objects into the air inlet or air outlet. The fan is rotating at high speed and will cause injury.
- Check the unit foundation for damage on a continuous basis, especially if it has been in use for a long time. If left in a damaged condition the unit may fall and cause injury.
- Do not touch the air outlet or horizontal blades while the swing flap is in operation because fingers could get caught and injured.
- Never touch the internal parts of the controller. Do not remove the front panel because some parts inside are dangerous to touch. To check and adjust internal parts, contact your dealer.
- Do not use means to accelerate the defrosting process or to clean, other than those recommended by the manufacturer.
- The appliance must be stored in a room without continuously operating ignition sources (for example: open flames, an operating gas appliance or an operating electric heater).
- Do not pierce or burn.
- Be aware that refrigerants may not contain an odor.

⚠ CAUTION

- Do not use the air conditioner or heat pump for any other purposes other than comfort cooling or heating. Do not use the unit for cooling precision instruments, food, plants, animals or works of art.
- Do not place items under the indoor unit as they may be damaged by condensates that may form if the humidity is above 80% or if the drain outlet gets blocked.
- Before cleaning, stop the operation of the unit by turning the power off or by pulling the supply cord out from its receptacle. Otherwise, an electric shock and injury may result.
- Do not wash the air conditioner or heat pump with excessive water. An electric shock or fire may result.
- Avoid placing the controller in a spot which may be splashed with water. Water entering the controller may cause an electric shock or damage the internal electronic parts.
- Do not operate the air conditioner or heat pump when using a room-fumigation type of insecticide. Failure to observe this could cause the chemicals to be deposited in the unit and can endanger the health of those who are hypersensitive to chemicals.
- Do not turn off the power immediately after stopping operation. Always wait for at least 5 minutes before turning off the power. Otherwise, water leakage may occur.
- The appliance is not intended for use by young children or infirm persons without supervision.
- The remote controller should be kept away from children so they cannot play with it.
- Consult with the installation contractor for cleaning.
- Incorrect cleaning of the inside of the air conditioner or heat pump could make the plastics parts break and cause water leakage or electric shock.
- Do not touch the air inlet or aluminum fin of the air conditioner or heat pump as they can cut and cause injury.
- Do not place objects in direct proximity of the outdoor unit. Do not let leaves and other debris accumulate around the unit. Leaves are a hotbed for small animals which can enter the unit. Once inside the unit, animals can cause the unit to malfunction, and cause smoke or fire when they make contact with electrical parts.

Safety Considerations

— ⚠ NOTE —

- Never press the button of the remote controller with a hard, pointed object. The remote controller may be damaged.
- Never pull or twist the electric wire of the remote controller. It may cause the unit to malfunction.
- Do not place appliances that produce open flames in places that are exposed to the airflow of the unit or under the indoor unit. It may cause incomplete combustion or deformation of the unit due to the heat.
- Do not expose the controller to direct sunlight. The LCD display can become discolored and may fail to display the data.
- Do not wipe the controller operation panel with benzene, thinner, chemical dust cloth, etc. The panel may get discolored or the coating can peel off. If it is heavily dirty, soak a cloth in water-diluted neutral detergent, squeeze it well and wipe the panel clean. Then wipe it with another dry cloth.
- Dismantling of the unit, disposal of the refrigerant, oil, and additional parts, should be done in accordance with the relevant local, state, and national regulations.
- Operate the air conditioner or heat pump in a sufficiently ventilated area and not surrounded by obstacles. Do not use the air conditioner or heat pump in the following places.
 - a. Places with a mist of mineral oil, such as cutting oil.
 - b. Locations such as coastal areas where there is a lot of salt in the air.
 - c. Locations such as hot springs where there is a lot of sulfur in the air.
 - d. Locations such as factories where the power voltage varies a lot.
 - e. In cars, boats, and other vehicles.
 - f. Locations such as kitchens where oil may splatter or where there is steam in the air.
 - g. Locations where equipment produces electromagnetic waves.
 - h. Places with an acid or alkaline mist.
 - i. Places where fallen leaves can accumulate or where weeds can grow.
- Take snow protection measures. Contact your dealer for the details of snow protection measures, such as the use of a snow protection hood.
- Do not attempt to do electrical work or grounding work unless you are licensed to do so. Consult with your dealer for electrical work and grounding work.
- Pay attention to operating sound. Be sure to use the following places:
 - a. Places that can sufficiently withstand the weight of the air conditioner or heat pump yet can suppress the operating sound and vibration.
 - b. Places where warm air from the air outlet of the outdoor unit or the operating sound of the outdoor unit does not annoy neighbors.
- Make sure that there are no obstacles close to the outdoor unit. Obstacles close to the outdoor unit may drop the performance of the outdoor unit or increase the operating sound of the outdoor unit.
- Consult your dealer if the air conditioner or heat pump in operation generates unusual noise.
- Make sure that the drainpipe is installed properly to drain water. If no water is discharged from the drainpipe while the air conditioner or heat pump is in the cooling mode, the drainpipe may be clogged with dust or dirt and water leakage from the indoor unit may occur. Stop operating the air conditioner or heat pump and contact your dealer.
- Do not spray the air conditioner unit with any deodorizers, etc. It may cause the unit to malfunction.

FFP002M-U

This is an appliance that is not accessible to the general public.

Names of Parts

Indoor Unit

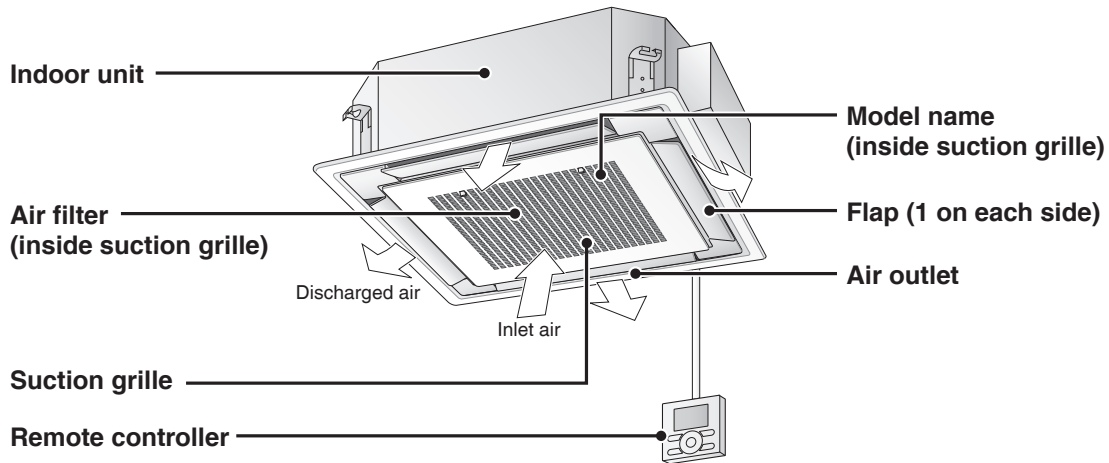

• The appearance of the suction grille and remote controller may differ between different models.

Decoration panel

Type A

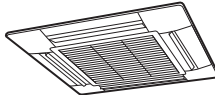

Type B

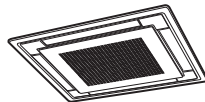

Remote controller

Wired type



Wireless type

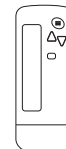

Outdoor Unit

• The appearance of the outdoor unit may differ between different models.

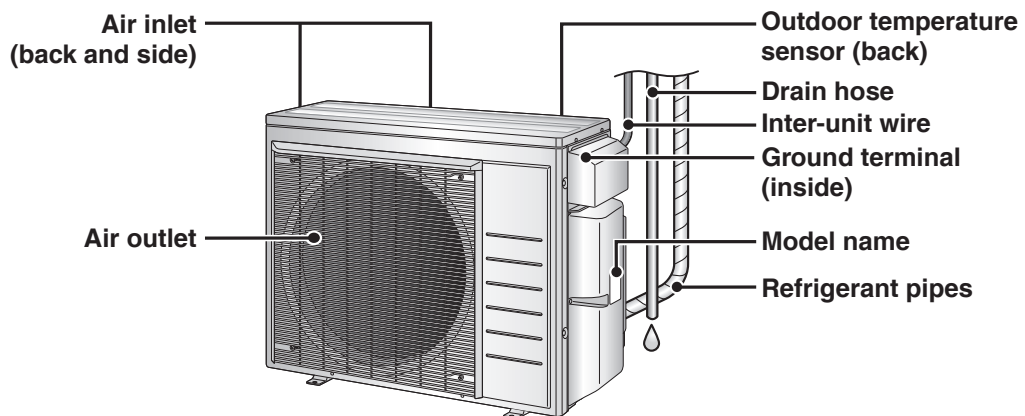

Note for Multi System

A multi system has one outdoor unit connected to multiple indoor units.

Selecting the operation mode

When the priority room setting is active but the set unit is not operating or when the priority room setting is inactive

When more than one indoor unit is operating, priority is given to the first unit that was turned on.

In this case, set the units that are turned on later to the same operation mode as the first unit.

Otherwise, they will enter the standby state, and when using the wired remote controller the centralized control icon "CENTRAL CONTROL" will light up; this does not indicate malfunction.

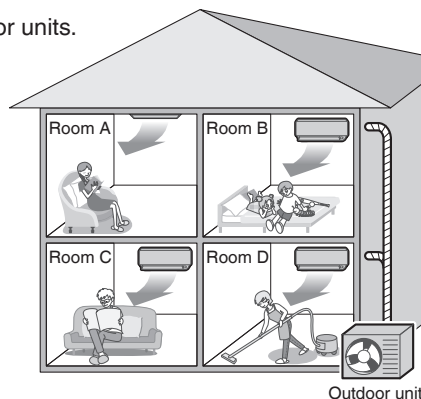

NOTE

Notes on operation mode for a multi system

- COOL, DRY and FAN operation may be used at the same time.
- AUTO operation automatically selects COOL operation or HEAT operation based on the indoor temperature. Therefore, AUTO operation is available when selecting the same operation mode as that of the room with the first unit to be turned on.

CAUTION

- Normally, the operation mode in the room where the unit is first started is given priority, but the following situations are exceptions to this rule. If the operation mode of the first room is FAN operation, then using HEAT operation in any room after this will give priority to HEAT operation. In this situation, the indoor unit operating in FAN mode will switch to standby, and when using the wired remote controller the centralized control icon "CENTRAL CONTROL" will light up.

With the priority room setting active

Refer to "Priority room setting" on the next page.

NIGHT QUIET mode (Available only for COOL operation)

NIGHT QUIET mode requires initial programming during installation. Please consult your retailer or dealer for assistance.

NIGHT QUIET mode reduces the operation noise of the outdoor unit during the night-time hours to prevent annoyance to neighbours.

- NIGHT QUIET mode is activated when the temperature drops 10.8°F (6°C) or more below the highest temperature recorded that day.
- When the temperature difference between the current outdoor temperature and the maximum outdoor temperature becomes less than 7.2°F (4°C), this function will be canceled.
- NIGHT QUIET mode slightly reduces the cooling efficiency of the unit.

QUIET OUTDOOR UNIT operation (Function unavailable in the FFQ series)

For details on QUIET OUTDOOR UNIT operation, refer to the operation manual included with the remote controller.

When the priority room setting is active but the set unit is not operating or when the priority room setting is inactive

When using the QUIET OUTDOOR UNIT operation feature with a multi system, set all indoor units to QUIET OUTDOOR UNIT operation using their remote controllers.

When canceling QUIET OUTDOOR UNIT operation, simply cancel the mode on one of the operating indoor units using their remote controller. However QUIET OUTDOOR UNIT operation will remain displayed on the remote controllers for the other rooms.

We recommend you cancel operation in all rooms using their remote controllers.

With the priority room setting active

Refer to "Priority room setting" on the next page.

COOL/HEAT mode lock

The COOL/HEAT mode lock requires initial programming during installation. Please consult your authorized dealer for assistance. The COOL/HEAT mode lock sets the unit forcibly to either COOL or HEAT operation. This function is convenient when you wish to set all indoor units connected to the multi system to the same operation mode.

NOTE

- The COOL/HEAT mode lock cannot be activated together with the priority room setting.

Priority room setting

The priority room setting requires initial programming during installation. Please consult your authorized dealer for assistance. The room designated as the priority room takes priority in the following situations.

Operation mode priority

- As the operation mode of the priority room takes precedence, you can select a different operation mode from other rooms.

[Example]

- Room A is the priority room in this example.
When COOL operation is selected in room A while operating the following modes in room B, C and D:

Operation mode in room B, C and D	Status of room B, C and D when the unit in room A is in COOL operation
COOL or DRY or FAN	The current operation mode is maintained.
HEAT	The unit enters the standby mode. Operation resumes when the room A unit stops operating.
AUTO	If the unit is set to COOL operation, it continues. If the unit is set to HEAT operation, it enters the standby mode. Operation resumes when the room A unit stops operating.

Priority when QUIET OUTDOOR UNIT operation is used (Function unavailable in the FFQ series)

[Example]

- Room A is the priority room in this example.
Just by setting the unit in room A to QUIET operation, the air conditioner starts QUIET OUTDOOR UNIT operation. You do not have to set all the indoor units in operation to QUIET OUTDOOR UNIT operation.

Priority when POWERFUL operation is used (Function unavailable in the FFQ series)

[Example]

- Room A is the priority room in this example.
The indoor units in rooms A, B, C and D are all operating. If the unit in room A enters POWERFUL operation, operation capacity will be concentrated in room A. In such a case, the cooling (heating) efficiency of the units in room B, C and D may be slightly reduced.

Care and Cleaning

WARNING

- Only a qualified service person is allowed to perform maintenance.
- Before cleaning, be sure to stop unit operation and turn off the circuit breaker.
Otherwise, an electric shock and injury may result.
- Contact a qualified person regarding the attachment of accessories and be sure to use only accessories specified by the manufacturer.
If an accessory is attached incorrectly, water leakage, an electric shock, or fire may result.

CAUTION

- When cleaning, use a sturdy and stable stand and watch your step.
- Make sure to firmly support the suction grille with your hand while performing maintenance tasks to prevent it from falling out.

■ Quick reference

Cleaning parts

Outside panel and flaps

- Wipe the parts with a soft cloth.
- When it is difficult to remove stains, use water or a neutral detergent.
- If the flaps are stained severely, contact your dealer and have the flaps replaced.

If dirty

Air filter

- Vacuum dust or wash the filter.

When the air filter cleaning time indicator lamp on the decoration panel lights up or when "Time to clean filter" displays on the wired remote controller

 Page 8

Remote controller

- Wipe them with a soft cloth.

If dirty

Suction grille

- Wipe it with a soft damp cloth.

If dirty  Page 9, 10

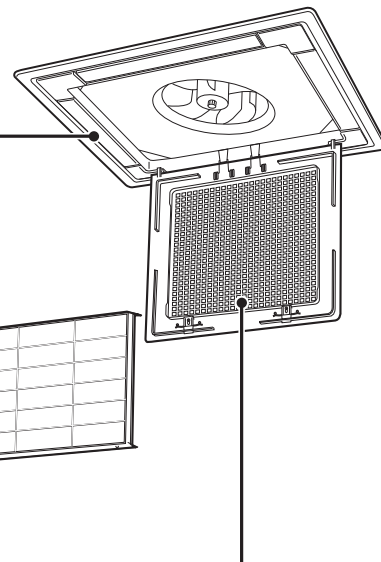

Notes on cleaning

For cleaning, do not use any of the following:

- Water hotter than 104°F (40°C)
- Volatile liquid such as benzene, gasoline and thinner
- Polishing compounds or liquid insecticide
- Rough materials such as a scrubbing brush
- Sprays such as deodorizers



■ Cleaning the air filter

Clean the air filter when the air filter cleaning time indicator lamp on the decoration panel lights up or when "Time to clean filter" displays on the wired remote controller.

- If the unit is installed in a room where the impurity content of the air is high, clean the filter more frequently.
- If the filter has become difficult to clean, replace the air filter. (Additional air filter sold separately.)

1. Open the suction grille.

- Push the 2 catches away from you and slowly open the suction grille. (To close, perform the steps in reverse.)

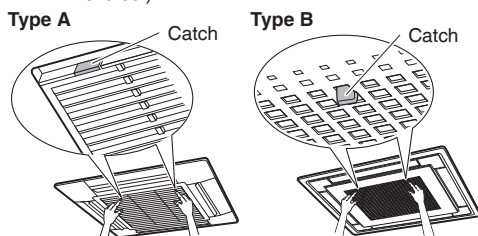

2. Remove the air filter.

- Pull the knobs of the air filter downward to disconnect the hooks, and remove the air filter.

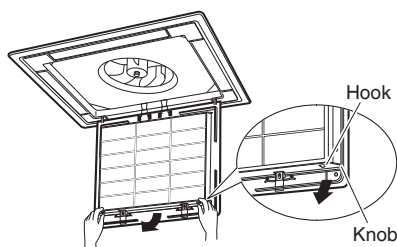

3. Clean the air filter with a vacuum cleaner or wash it with water.

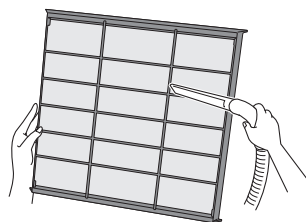

If the dust does not come off easily

- Wash the air filter using a soft brush and a neutral detergent, then let it dry in the shade.



4. Reattach the air filter.

- 4-1 Hook one side of the air filter on to the protrusions on the suction grille.
- 4-2 Push the other side of the air filter into place.

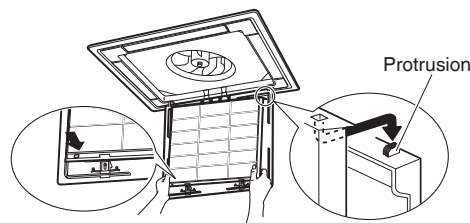

5. Close the suction grille.

- Refer to STEP 1.

6. After turning on the power, reset the filter sign in accordance with the instructions in the operation manual for the wired remote controller or wireless remote controller.

- The air filter cleaning time indicator lamp on the decoration panel turns off or "Time to clean filter" disappears from the display on the wired remote controller.

Care and Cleaning

■ Cleaning the suction grille (for type A)

1. Open the suction grille.

- Push the 2 catches away from you and slowly open the suction grille. (To close, perform the steps in reverse.)

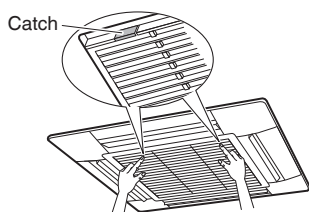

2. Remove the suction grille.

- Open the suction grille until it is 45 degrees to the ceiling and then lift it upward.

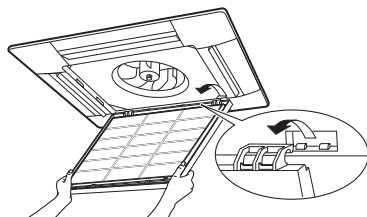

3. Remove the air filter. ▶Page 8

4. Clean the suction grille.

Wash with a soft bristle brush and a neutral detergent or water, and dry thoroughly.



- **When very dirty**
Directly apply the type of detergent used for cleaning ventilation fans or ovens, wait for about 10 minutes, and then rinse with water.

5. Reattach the air filter. ▶Page 8

6. Reattach the suction grille.

- Refer to STEP 2.

7. Close the suction grille.

- Refer to STEP 1.

■ Cleaning the suction grille (for type B)

1. Open the suction grille.

- Push the 2 catches away from you and slowly open the suction grille. (To close, perform the steps in reverse.)

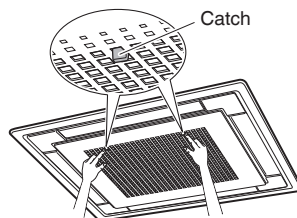

2. Remove the suction grille.

- Open the suction grille so that it hangs by the hinges at 90 degrees to the ceiling.
- Pinch the wire catches inward as shown in the figure.

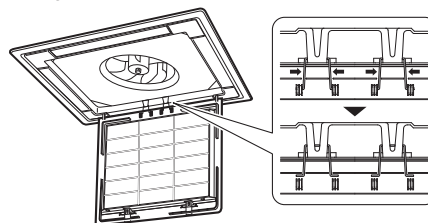

3. Remove the air filter. ▶Page 8

4. Clean the suction grille.

Wash with a soft bristle brush and a neutral detergent or water, and dry thoroughly.



- **When very dirty**

Directly apply the type of detergent used for cleaning ventilation fans or ovens, wait for about 10 minutes, and then rinse with water.

5. Reattach the air filter. ▶ Page 8

6. Reattach the suction grille.

- Refer to STEP 2.

7. Close the suction grille.

- Refer to STEP 1.

■ Prior to a long period of non-use

1. Operate the FAN mode for several hours to dry out the inside.

- To start the operation, refer to the operation manual for the remote controller.

2. After operation stops, turn off the circuit breaker for the room air conditioner.

3. Clean the air filter and reattach it.

4. To prevent battery leakage, take out the batteries from the remote controller. (Only for the wireless remote controller)

■ We recommend periodical maintenance

- In certain operating conditions, the inside of the air conditioner may get foul after several seasons of use, resulting in poor performance. It is recommended to have periodical maintenance by a qualified contractor.
- For qualified contractor maintenance, please contact the dealer where you bought the air conditioner.

Troubleshooting

Before making an inquiry or a request for repair, please check the following.
If the problem persists, consult your dealer.



Not a problem

This case is not a problem.



Check

Please check again before requesting repairs.

Case	Description / what to check
Operation does not start soon. <ul style="list-style-type: none"> When ON/OFF button was pressed soon after operation was stopped. When the mode was reselected. 	<input checked="" type="checkbox"/> <ul style="list-style-type: none"> This is to protect the air conditioner. You should wait for about 3 minutes.
Air does not come out.	<input checked="" type="checkbox"/> <ul style="list-style-type: none"> In HEAT operation <ul style="list-style-type: none"> The air conditioner is warming up. Wait for about 1 to 4 minutes. During defrosting operation, hot air does not flow out of the indoor unit. When the air conditioner operates immediately after the circuit breaker is turned on <ul style="list-style-type: none"> The air conditioner is preparing to operate. Wait for about 3 to 20 minutes.
The HEAT operation stops suddenly and a flowing sound is heard.	<input checked="" type="checkbox"/> <ul style="list-style-type: none"> The system is taking away the frost on the outdoor unit. You should wait for about 4 to 12 minutes.
The outdoor unit emits water or steam.	<input checked="" type="checkbox"/> <ul style="list-style-type: none"> In HEAT mode <ul style="list-style-type: none"> The frost on the outdoor unit melts into water or steam when the air conditioner is in defrost operation. In COOL or DRY mode <ul style="list-style-type: none"> Moisture in the air condenses into water on the cool surface of outdoor unit piping and drips.
Mist comes out of the indoor unit.	<input checked="" type="checkbox"/> <ul style="list-style-type: none"> This happens when the air in the room is cooled into mist by the cold airflow during cooling operation.
The indoor unit gives out odor.	<input checked="" type="checkbox"/> <ul style="list-style-type: none"> This happens when smells of the room, furniture, or cigarettes are absorbed into the unit and discharged with the airflow. (If this happens, we recommend you to have the indoor unit washed by a technician. Consult your dealer where you bought the air conditioner.)
The outdoor fan rotates while the air conditioner is not in operation.	<input checked="" type="checkbox"/> <ul style="list-style-type: none"> After operation is stopped: <ul style="list-style-type: none"> The outdoor fan continues rotating for another 1 minute for system protection. While the air conditioner is not in operation: <ul style="list-style-type: none"> When the outdoor temperature is very high, the outdoor fan starts rotating for system protection.
The operation stopped suddenly. (OPERATION lamp* is on.)	<input checked="" type="checkbox"/> <ul style="list-style-type: none"> For system protection, the air conditioner may stop operating on a sudden large voltage fluctuation. It automatically resumes operation in about 3 minutes. Are operation modes all the same for indoor units connected to outdoor units in the multi system? If not, set all indoor units to the same operation mode.
The air conditioner does not operate. (OPERATION lamp* is off.)	<input type="checkbox"/> <ul style="list-style-type: none"> Hasn't the circuit breaker turned OFF or a fuse blown? Isn't it a power failure? Are batteries set in the remote controller? Is the timer setting correct?
Cooling (Heating) effect is poor.	<input type="checkbox"/> <ul style="list-style-type: none"> Are the air filters clean? Is there anything blocking the air inlet or the outlet of the indoor and the outdoor units? Is the temperature setting appropriate? Are the windows and doors closed? Are the airflow rate and the air direction set appropriately?
Operation stops suddenly. (OPERATION lamp* is blinking.)	<input type="checkbox"/> <ul style="list-style-type: none"> Are the air filters clean? Is there anything blocking the air inlet or the outlet of the indoor and the outdoor units? Clean the air filters or take all obstacles away and turn the circuit breaker OFF. Then turn it ON again and try operating the air conditioner with the remote controller. If the lamp still blinks, call your dealer where you bought the air conditioner.

* The OPERATION lamp is on the receiver of the separately sold wireless remote controller or wired remote controller.

Case	Description / what to check
An abnormal functioning happens during operation.	 • The air conditioner may malfunction with lightning or radio waves. Turn the breaker OFF, turn it ON again and try operating the air conditioner with the remote controller.

Notes on the operating conditions

- If operation continues under any conditions other than those listed in the table,
 - A safety device may activate to stop the operation. (With a multi connection in COOL operation, the safety device may work to stop the operation of the outdoor unit only.)
 - Dew may form on the indoor unit and drip from it when COOL or DRY operation is selected.
- *1 Cutting the jumper on the outdoor unit PCB will extend the cooling operation range to 14°F (-10.0°C). Installing an air direction adjustment grille (sold separately) will further extend the operation range to -4°F (-20.0°C). Please consult your dealer.
- *2 Installing a drain pan heater (sold separately) will further extend the heating operation range to -13°F (-25.0°C). Please consult your dealer.

Mode	Operating conditions
COOL / DRY	Outdoor temperature: [MXS, MXL, MXLH models]: 14 - 115°F (-10 - 46°C) [RX models] : 50*1 - 115°F (10*1 - 46°C) *1 -4°F (-20°C) If an air direction adjustment grille (sold separately) is installed.
	Indoor temperature : 64 - 90°F (18 - 32°C) Indoor humidity : 80% max.
HEAT	Outdoor temperature: [MXS models] : 5 - 75°F (-15 - 24°C) [MXL models] : 5*2 - 75°F (-15*2 - 24°C) [MXLH models] : -13 - 75°F (-25 - 24°C) [RX models] : 5 - 75°F (-15 - 24°C) *2 -13°F (-25°C) If a drain pan heater (sold separately) is installed.
	Indoor temperature : 50 - 86°F (10 - 30°C)

■ Call your dealer immediately

 **WARNING**

When an abnormality (such as a burning smell) occurs, stop operation and turn off the circuit breaker.

- Continued operation in an abnormal condition may result in problems, electric shock or fire.
- Consult the dealer where you bought the air conditioner.

Do not attempt to repair or modify the air conditioner by yourself.

- Incorrect work may result in electric shock or fire.
- Consult the dealer where you bought the air conditioner.

If one of the following symptoms takes place, call your dealer immediately.

<ul style="list-style-type: none"> • The power cord is abnormally hot or damaged. • An abnormal sound is heard during operation. • The circuit breaker cuts off the operation frequently. • A switch or a button often fails to work properly. • There is a burning smell. • Water leaks from the indoor unit. 	Turn off the circuit breaker and call your dealer. 
--	--

- **After a power failure**
 - The air conditioner automatically resumes operation in about 3 minutes. You should just wait for a while.
- **Lightning**
 - If there is a risk lightning could strike in the neighborhood, stop operation and turn off the circuit breaker to protect the system.

■ Disposal requirements

- Dismantling of the unit, handling of the refrigerant, oil and other parts, should be done in accordance with the relevant local and national regulations.

2.6 BRC1E73

Safety Considerations



The original instructions are written in English. All other languages are translation of the original instructions.

Read these **SAFETY CONSIDERATIONS** carefully before operating the remote controller.





Train the customer to operate and maintain the remote controller.





Inform customers that they should store this Operations Manual with the Installation Manual for future reference.

Meanings of **WARNING** and **CAUTION** Symbols:







 WARNING	Indicates a potentially hazardous situation which, if not avoided, could result in death or serious injury.
 CAUTION	Indicates a potentially hazardous situation which, if not avoided, may result in minor or moderate injury. It may also be used to alert against unsafe practices.
 NOTE	Indicates situations that may result in equipment or property-damage accidents only.





- The following pictograms are used in this manual.

	Never do.		Always follow the instructions given.
	Keep water and moisture away.		Keep wet hands away.

 WARNING	
	<ul style="list-style-type: none"> • Do not modify or repair the remote controller. Consult your Daikin dealer for any modification or for repairs.
	<ul style="list-style-type: none"> • Do not relocate or reinstall the remote controller by yourself. Improper installation may result in electric shocks or fire. Consult your Daikin dealer to relocate or for any reinstallation.
	<ul style="list-style-type: none"> • Do not use flammable materials (e.g., hairspray or insecticide) near the remote controller. Do not clean the product with organic solvents such as paint thinner. The use of organic solvents may cause cracking, damaging the product, causing electric shocks, or fire.
	<ul style="list-style-type: none"> • Consult the dealer if the remote controller was submerged under water due to a natural disaster, such as a flood or hurricane. Do not operate the remote controller at this time or a malfunction, electric shock, or fire can occur.

—Items to be Strictly Observed—

 CAUTION	
	<ul style="list-style-type: none"> • Do not allow children to play with the remote controller to avoid causing damage to the product.
	<ul style="list-style-type: none"> • Never disassemble the remote controller. Touching the interior parts may result in electric shocks or fire. Consult your Daikin dealer for internal inspections and adjustments.
	<ul style="list-style-type: none"> • Do not touch the remote controller buttons with wet fingers. Touching the buttons with wet fingers can cause an electric shock.
	<ul style="list-style-type: none"> • Do not wash the remote controller. Doing so may cause electric leakage and result in electric shocks or fire.
	<ul style="list-style-type: none"> • Never let the remote controller to get wet. Water can cause damage to the remote controller, and may cause an electric shock or fire.

 NOTE	
	<ul style="list-style-type: none"> • Never press the button of the remote controller with a hard and pointed object. The remote controller may be damaged.
	<ul style="list-style-type: none"> • Never pull or twist the electric wire of the remote controller. It may cause the unit to malfunction.
	<ul style="list-style-type: none"> • Do not wipe the remote controller with benzine, thinner, chemical dustcloth, etc. The remote controller may get discolored or the coating peeled off. If it is heavily dirty, soak a cloth in water-diluted neutral detergent, squeeze it well and wipe the remote controller clean. And wipe it with another dry cloth.

Button Locations and Descriptions

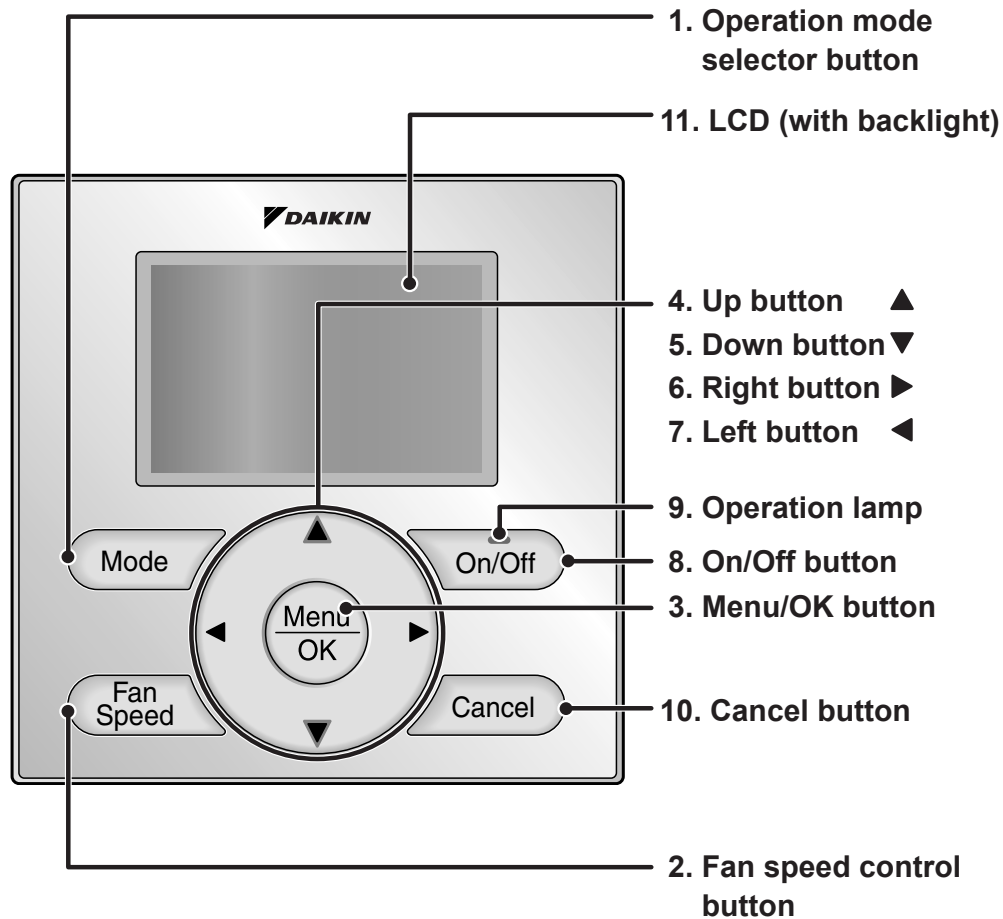

Functions other than basic operation items (i.e., On/Off, Operation Mode, Fan Speed, and Setpoint) are set from the menu screen.

NOTE

- Do not install the remote controller in places exposed to direct sunlight, the LCD will be damaged.
- Do not pull or twist the remote controller cord, the remote controller may be damaged.
- Do not use objects with sharp ends to press the buttons on the remote controller, damage may result.

1. Operation mode selector button

- Press this button to select the operation mode of your preference. **(See page 10.)**
- * Available modes vary with the indoor unit model.

2. Fan speed control button

- Press this button to select the fan speed of your preference. **(See page 11.)**
- * Available fan speeds vary with the indoor unit model.

3. Menu/OK button

- Used to enter the main menu. **(See page 20 for the menu items.)**
- Used to enter the selected item.

4. Up button ▲

- Used to raise the setpoint.
- The item above the current selection will be highlighted.
(The highlighted items will be scrolled continuously when the button is continuously pressed.)
- Used to change the selected item.

5. Down button ▼

- Used to lower the setpoint.
- The item below the current selection will be highlighted.
(The highlighted items will be scrolled continuously when the button is continuously pressed.)
- Used to change the selected item.

6. Right button ►

- Used to highlight the next items on the right-hand side.
- Each screen is scrolled in the right-hand direction.

7. Left button ◀

- Used to highlight the next items on the left-hand side.
- Each screen is scrolled in the left-hand direction.

8. On/Off button

- Press this button and system will start.
- Press this button again to stop the system.

9. Operation lamp

- This lamp illuminates solid green during normal operation.
- This lamp flashes if an error occurs.

10. Cancel button

- Used to return to the previous screen.

11. LCD (with backlight)

- The backlight will be illuminated for approximately 30 seconds by pressing any button.
- If two remote controllers are used to control a single indoor unit, only the controller accessed first will have backlight functionality.

Names and Functions

Liquid Crystal Display

- Three types of display mode (Standard, Detailed and Simple) are available.
- Standard display is set by default.
- Detailed and Simple displays can be selected in the main menu. (See page 40.)

Standard display

The standard display screen shows the following elements:

- 1. Operation mode:** Auto Cool
- 2. Fan Speed:** Represented by a bar chart with three bars of increasing height.
- 3. Setpoint:** Set to Cool 74°F and Heat 70°F
- 4. Stand by for Defrost/Hot start:** STANDBY indicator
- 5. Message:** This function is not available
- 6. Ventilation:** AUTO ERV and AIR PURIFY indicators
- 7. Key Lock:** Key lock icon
- 8. Scheduled:** Scheduled icon (⌚)
- 9. Under centralized control:** CENTRAL CONTROL and MASTER CONTROLLED indicators
- 10. Changeover controlled by the master indoor unit:** SETBACK indicator
- 11. Setback:** SETBACK indicator

<Standard display example>

Detailed display

- The airflow direction, clock, and selectable item appear on Detailed display screen in addition to the items appearing on Standard display.

The detailed display screen (example 1) shows the following elements:

- 12. Airflow Direction:** (Displayed only when the indoor unit is turned on.)
- 13. Current Day/Time (12/24 hour time display):** Fri 11:03A
- 14. Selectable Display Item:** A button with a square icon

<Detailed display example 1>

The detailed display screen (example 2) shows the following disabled features:

- No Fan speed display:** (with no fan speed control function)
- No Airflow Direction display:** (with no airflow direction settings)
- No Clock display:** (when the clock has not been set yet)
- 15. (X) Unable to schedule:** Scheduled icon is crossed out
- No Selectable Display Item:** (with no selectable display item selected)

<Detailed display example 2>

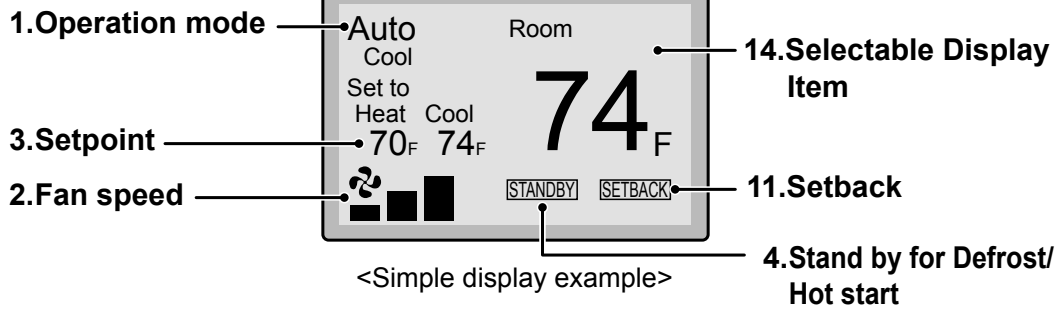
Simple display**Note for all display modes**

- Depending on the field settings, while the indoor unit is stopped, OFF may be displayed instead of the operation mode and/or the setpoint may not be displayed.

Names and Functions

1. Operation mode

- Used to display the current operation mode: Cool, Heat, Vent, Fan, Dry or Auto.
- In Auto mode, the actual operation mode (Cool or Heat) will be also displayed.
- Operation mode cannot be changed when OFF is displayed. Operation mode can be changed after starting operation.

2. Fan Speed

- Used to display the fan speed that is set for the indoor unit.
- The fan speed will not be displayed if the connected model does not have fan speed control functionality.

3. Setpoint

- Used to display the setpoint for the indoor unit.
- Use the Celsius/Fahrenheit item in the main menu to select the temperature unit (Celsius or Fahrenheit).

4. Stand by for Defrost/Hot start

“  ” (See page 12.)

If ventilation icon is displayed in this field:

- Indicates that an energy recovery ventilator (ERV) is connected. For details, refer to the Operation Manual of the ERV.

5. Message

The following messages may be displayed.

“This function is not available”

- Displayed for a few seconds when an Operation button is pressed and the indoor unit does not provide the corresponding function.
- In a remote control group, the message will not appear if at least one of the indoor units provides the corresponding function.

“Error: Push Menu button”

“Warning: Push Menu button”

- Displayed if an error or warning is detected (see page 50).



“Time to clean filter”

“Time to clean element”

“Time to clean filter & element”

- Displayed as a reminder when it is time to clean the filter and/or element (see page 48).

6. Ventilation

- Displayed when an energy recovery ventilator is connected.
- **Ventilation Mode icon.** “  ” These icons indicate the current ventilation mode (ERV only) (AUTO, ERV, BYPASS).
- **Air Purify ICON** “  ” This icon indicates that the air purifying unit (Optional) is in operation.

7. Key Lock (See page 19.)

- Displayed when the key lock is set.

8. Scheduled (See page 30.)

- Displayed if the Schedule or Off timer is enabled.

9. Under Centralized control “ ”

- Displayed if the system is under the management of a multi-zone controller (Optional) and the operation of the system through the remote controller is limited.

10. Changeover controlled by the master indoor unit “ ”

(VRV only)

- Displayed when another indoor unit on the system has the authority to change the operation mode between cool and heat.

11. Setback “” (See page 14.)

- The setback icon flashes when the unit is turned on by the setback control.

12. Airflow Direction “”

- Displayed when the airflow direction and swing are set (see page 23).
- If the connected indoor unit model does not include oscillating louvers this item will not be displayed.

13. Current Day/Time (12/24 hour time display)

- Displayed if the clock is set (see page 42).
- If the clock is not set, “-- : --” will be displayed.
- 12 hour time format is displayed by default.
- Select 12/24 hour time display option in the main menu under “Clock & Calendar”.

14. Selectable Display Item

- Room temperature is selected by default.
- For other choices see page 41.

15. Unable to schedule

- Displayed when the clock needs to be set.
- The schedule function will not work unless the clock is set.

Basic Operation

Cool/Heat/Auto/Fan Operation (SkyAir and VRV)

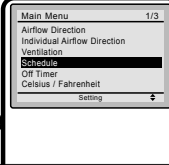
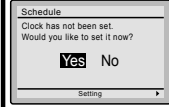
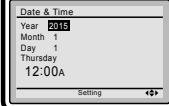
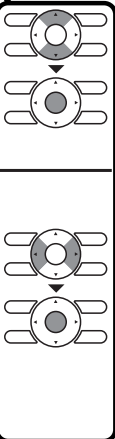
How to follow the operation manual	Operation procedure	Operation button display
<p>Operation screen display</p> <p>Describes screens that will be displayed on the remote controller in operation.</p>	<p>Explains the sequence of operation for the remote controller. Operate the buttons according to the procedure.</p>	<p>Displays the location of buttons to be operated.</p>
<p>Operation</p> <p>1</p>  <p>2</p>  	<ul style="list-style-type: none"> • Display the main menu screen. (See page 22.) • Press ▼▲ buttons to select Schedule the main menu screen. Press Menu/OK button to display the timer screen. • Before setting the schedule, the clock must be set. • If the clock has not been set, a screen like the one on the left will appear. Press ◀▶ buttons to select Yes and press Menu/OK button. • The date & time screen will appear. • Set the current year, month, day, and time. (See clock settings on page 42.) 	

Preparation

- For mechanical protection purposes, apply power to the outdoor units at least six hours before starting the operation of the system.

Operation

1

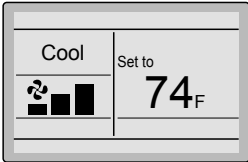

• Press **Mode** button several times until the desired mode Cool, Heat, Fan, or Auto mode is selected.

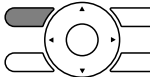

* Unavailable operation modes are not displayed.

Note

- Both heat and cool mode may not be selected if the unit is master controlled. See page 16 if MASTER CONTROLLED icon flashes.

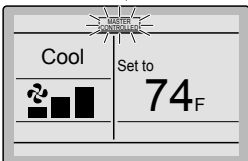

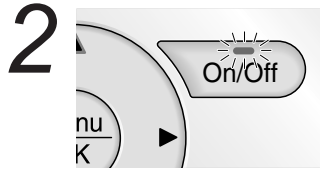

- Press **On/Off** button.
The Operation lamp will illuminate solid green and the system will start operating.

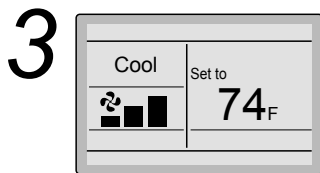
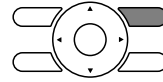

- The setpoint will increase by 1°F (or 1°C) when ▲ button is pressed and decrease by 1°F (or 1°C) when ▼ button is pressed.

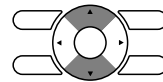

* Setpoint is not available in fan or dry mode.

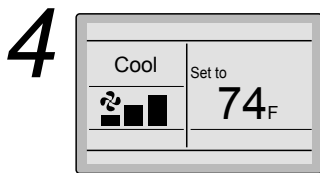

- To change the fan speed, press **Fan Speed** button and select the fan speed from;



- Low/High/Auto for two-speed
- Low/Medium/High/Auto for three-speed
- Low/Med Low/Medium/Med High/High/Auto for five-speed depending on the indoor unit model.

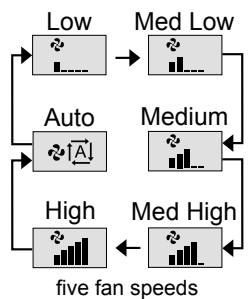
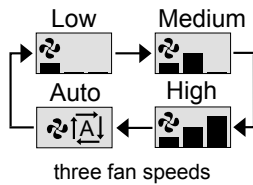

- * Auto cannot be selected if the indoor unit does not have Auto Fan speed function.
- * The system may change the fan speed automatically for equipment protection purposes.
- * The system may turn off the fan when the room temperature is satisfied.
- * It is normal for a delay to occur when changing the fan speed.
- * If the Auto is selected for the fan speed, the fan speed varies automatically based on the difference between setpoint and room temperature.

Basic Operation

5

- Adjust Airflow Direction from the main menu (see page 23).

* If the connected indoor unit does not have oscillating louvers, this function will not be available.

6



- When **On/Off** button is pressed again, the system will stop operating and the Operation lamp will turn off.



* When the system is stopped while in the heating mode, the fan will continue to operate for approximately one minute to remove residual heat from the indoor unit.

Note

- To prevent condensation water damage or system failure, do not shut off the power supply to the indoor unit immediately after operation. Wait at least five minutes for the condensate pump to finish draining residual water from the indoor unit.

Characteristics of Heat Mode

The system automatically controls the following operating modes to prevent the reduction of heating capacity and space comfort.

Defrost operation

- The system will automatically go into defrost operation to prevent frost accumulation at the outdoor unit and subsequent loss of heating capacity.
- The indoor unit fan will stop, and "STANDBY" will be displayed on the remote controller.
- The system will finish the Defrost operation and return to normal usually within six to eight minutes. It won't last for more than ten minutes.

Hot start

- When the system starts heating operation, the indoor unit fan will operate with a delay in order to prevent a cold draft. (In that case, "STANDBY" will be displayed on the remote controller.)

Dry Mode

Preparation

- For equipment protection purposes, apply power to the outdoor units at least six hours before starting the operation of the system.
- The dry mode may not be selected if the remote controller is master controlled and the system is not already in the cooling mode of operation. (see page 18 for details)

Operation

1

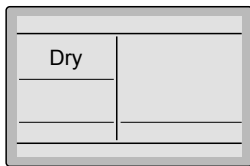

- Press **Mode** button several times until the Dry mode is selected.

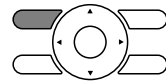

* The dry mode may not be available depending on the type of indoor unit.

2

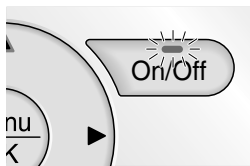

- Press **On/Off** button. The Operation lamp will illuminate solid green and the system will start operating.



* In Dry mode, the system maintains automatic temperature and fan speed control. Therefore, temperature setpoint or fan speed settings are not available while the indoor unit is in the Dry mode.

3

- Adjust Airflow Direction from the main menu (see page 23).

* If the connected indoor unit does not have oscillating louvers, this function will not be available.

Basic Operation

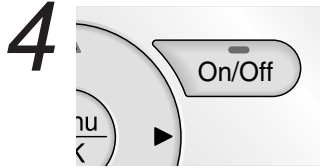

- When **On/Off** button is pressed again, the system will stop operating and the Operation lamp will turn off.



Note

- To prevent condensation water damage or system failure, do not shut off the power supply to the indoor unit immediately after operation. Wait at least five minutes for the condensate pump to finish draining residual water from the indoor unit.

Characteristic of Dry mode

The Dry mode dehumidifies the space at reduced cooling capacity to prevent the room temperature from dropping to an uncomfortable level.

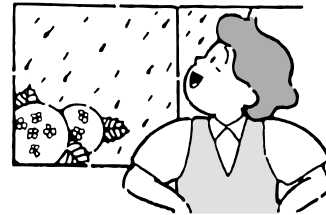

Setback

The Setback function can be used to maintain the space temperature in an assigned range for an unoccupied period.

Note

- When enabled, the Setback mode becomes active when the indoor unit is turned off by either the user, a schedule event or an off timer.
- This function is not available by default. It can be enabled by the system installer.

Operation

1

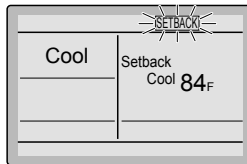
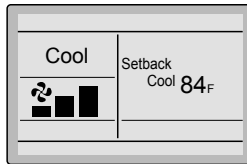

- The setback icon flashes when the unit is turned on by the setback control.

Ventilation Mode When the Indoor Unit is Interlocked with Energy Recovery Ventilator

Preparation

- For equipment protection purposes, apply power to the outdoor units at least six hours before starting the operation of the system.

Operation

1

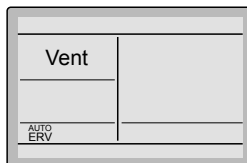

- When operating the energy recovery ventilator (ERV) between seasons without the indoor unit, set the control to ventilation mode.

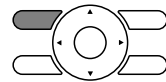

2

- Changes to the ventilation mode are made from the main menu.

* Ventilation Mode: Auto, ERV, and Bypass

3

- Changes to the ventilation rate are made from the main menu.

* Ventilation Rate: Low or High

Basic Operation



- Press **On/Off** button.
The Operation lamp will illuminate solid green and the system will start operating.



- When **On/Off** button is pressed again, the system will stop operating and the Operation lamp will turn off.



Setting the Cool / Heat Changeover Master

(VRV only)

Setting Changes See page 18 for an explanation of the cool/heat changeover master indoor unit.

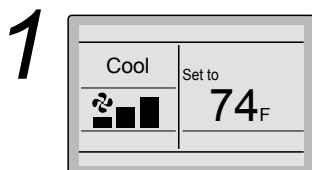

- Press **Mode** button on the remote controller of the changeover master indoor unit for at least four seconds while the backlight is illuminated.

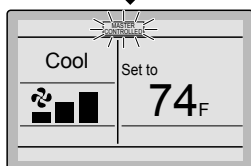
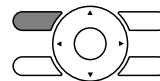

- The “**MASTER CONTROLLED**” icon on each remote controller for the indoor units connected to the same outdoor unit or Branch Selector unit will start flashing.
- * Vent mode setting changes are possible regardless of the cool/heat changeover master indoor unit.
* If the outdoor unit is configured as cool/heat changeover master, all remote controllers serving the associated indoor units will display its “**MASTER CONTROLLED**” icon.
- Set the cool/heat changeover master indoor unit as outlined below.

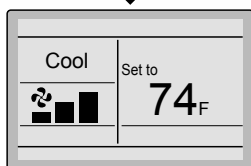
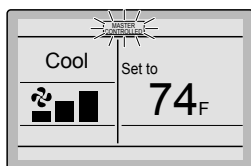

Selection Settings The icon "  " will flash on all remote controllers when the power is turned ON for the first time.

2



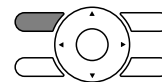

- Press **Mode** button on the remote controller of the indoor unit which is to serve as the cool/heat changeover master.

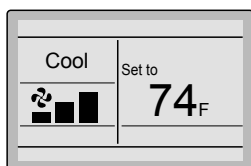

The remote controller for the changeover master indoor unit is established and the  icon is no longer displayed. Other remote controllers in the system (indoor units served by the same outdoor unit or indoor units served by the same branch selector unit) will now display the  icon.

3



- Press **Mode** button on the remote controller of the indoor unit designated as the cool/heat changeover master (the remote controller not displaying the  icon) repeatedly until the desired mode is selected. The display will change to **Fan, Dry, Auto, Cool, Heat** each time the button is pressed.
- Simultaneously, the other indoor units on the system will follow suit and change modes to reflect the new mode selected at the changeover master remote controller.

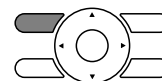

Basic Operation

Cool / Heat Mode Selection Availability

- “Cool”, “Heat”, and “Auto” are all only available for selection on the cool/heat changeover master indoor unit. The following table indicates the available operating modes of the other indoor units on the system based upon the selected mode of the master indoor unit.

When the master indoor unit is set to	The other indoor units in the system can be set to			
	Cool	Dry	Heat	Fan
Cool mode	✓	✓		✓
Dry mode	✓	✓		✓
Heat mode			✓	✓
Fan mode				✓
Auto mode (Cooling operation)	✓	✓		✓
Auto mode (Heating operation)			✓	✓

Precautions for Selecting the Cool / Heat Changeover Master Indoor Unit

- The cool/heat changeover master must be set for a single indoor unit in the following applications

(2-Pipe Heat Pump System)

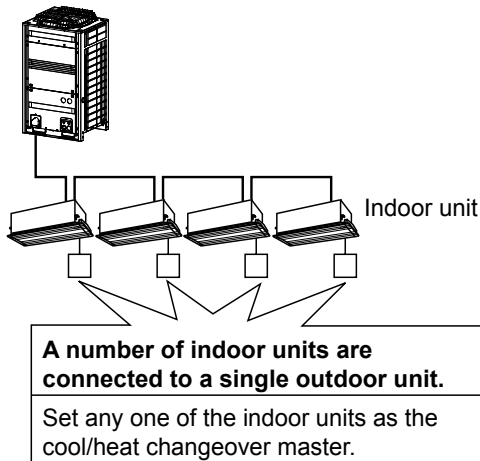

(3-Pipe Heat Recovery System)

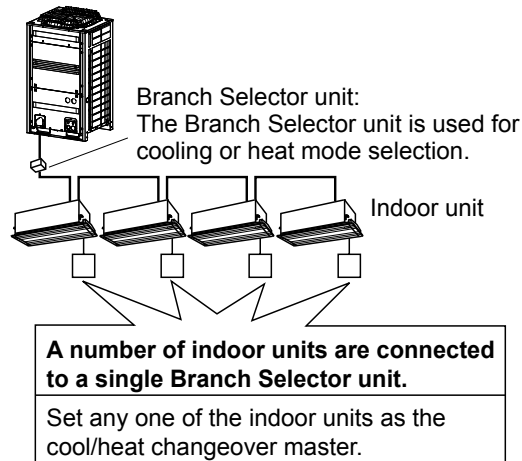

Key Lock

Operation Confirm and cancel Key Lock settings in the basic display screen.

1

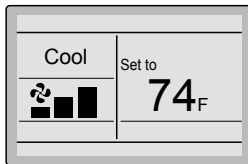

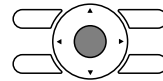

Basic screen

- Press **Menu/OK** button for at least four seconds while the backlight is illuminated.

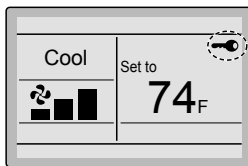

2



- “” is displayed. All buttons are disabled when the keys are locked.
- To cancel the key lock mode, continue pressing **Menu/OK** button for at least four seconds while the backlight is illuminated.

Quick Reference

■ The main menu has the following items.

Menu item		Description	Reference page
Airflow Direction		<p>Used to configure airflow direction settings.</p> <ul style="list-style-type: none"> The airflow direction louver is automatically operated up and down (left and right). The fixed airflow directions are configurable for five positions. <p>* This function is not available on all indoor unit models.</p>	23
Individual Airflow Direction (depends on indoor unit model)	Louver Setting	<p>Set the airflow direction individually for each of the 4 louvers.</p> <ul style="list-style-type: none"> Maximum 16 units (unit 0 till 15). 	25
	Louver Setting List	Setting table for louver.	26
	Reset All Louvers Position	Reset all louvers to factory default setting.	27
Ventilation (Ventilation operation settings for energy recovery ventilator)	Ventilation Rate	Used to set "Low" or "High"	28
	Ventilation Mode	Used to set Auto, ERV, or Bypass.	29
Schedule	Daily Patterns	<ul style="list-style-type: none"> Day settings are selected from four patterns, i.e., "7Days", "Weekday/Sat/Sun", "Weekday/Weekend", and "Everyday". 	31
	Settings	<ul style="list-style-type: none"> Set the startup time and operation stop time. <ul style="list-style-type: none"> ON: Startup time, cooling and heating temperature setpoints can be configured. OFF: Operation stop time, cooling and heating setback temperature setpoints can be configured. (--: Indicates that the setback function is disabled for this time period.) ___: Indicates that the temperature setpoint and setback temperature setpoint for this time period is not specified. The last active setpoint will be utilized. Up to five actions can be set for each day. 	32
Off Timer		<p>Used to set the run-time for the indoor unit using this controller.</p> <ul style="list-style-type: none"> Possible to set in 10 minute increments from 30 to 180 minutes. 	35
Celsius / Fahrenheit		<ul style="list-style-type: none"> Used to select whether temperature values will be displayed in Celsius or Fahrenheit. 	—

Menu item		Description	Reference page
Filter Auto Clean		Set the time when the filter needs to be automatically cleaned. For the detailed operation refer to the Operation Manual of the self cleaning decoration panel.	—
Maintenance Information		Used to display the maintenance information.	37
Configuration	Draft Prevention (Only available with Occ. sensor installed indoor unit model)	The draft prevention function can be enabled or disabled . When enabled, the Occ. sensor will adjust the louver's position to prevent air blowing directly on occupant.	38
	Contrast Adjustment	Used to make LCD contrast adjustment.	39
	Display	Used to set the display mode. <ul style="list-style-type: none"> • Display mode Standard, Detailed, or Simple display • Detailed and Simple displays provide the selectable display item among Room Temp, System, None or Outside Air Temp. 	40
Current Settings		<ul style="list-style-type: none"> • Used to display a list of current settings for available items. 	42
Clock & Calendar	Date & Time	Used to configure date and time settings and corrections. <ul style="list-style-type: none"> • The default time display is 12H. • The clock will maintain accuracy to within ±30 seconds per month. • If there is a power failure for a period not exceeding 48 hours, the clock will continue working with the built-in backup power supply. 	42
	12H/24H Clock	The time can be displayed in either a 12 hour or a 24 hour time format.	45
Daylight Saving Time		Used to adjust the clock in observance of daylight saving time.	45
Language		The display language can be selected between English, Francais, or Espanol.	48

Note: Available setting items vary with the indoor unit model.

Sub Remote Controller Menu Items		
If two remote controllers are connected to a single indoor unit, the following menu items are not set in the sub remote controller. In this case, the following items should be configured in the main remote controller.		
<ul style="list-style-type: none"> • Individual Airflow Direction • Schedule • Off timer 	<ul style="list-style-type: none"> • Setback • Draft Prevention 	

Menu Options

Navigating the Main Menu Screen

■ Display Method for Main Menu

Operation

1

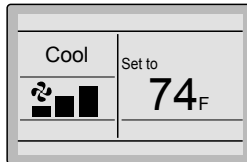

Basic screen

- Press **Menu/OK** button.

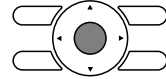

2

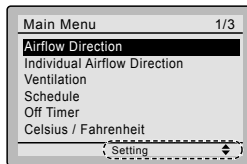

Main menu screen

- The main menu screen is displayed.

⇐ Instructions for navigating the main menu will appear.

3

- Selecting items from the main menu.
 1. Press ▼▲ buttons to select the desired item to be set.
 2. Press **Menu/OK** button to display the details for the selected item.

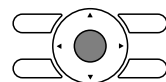
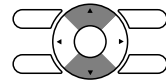

4

- To go back to the basic screen from the main menu, press **Cancel** button.

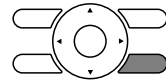

Note

- If a button is not pressed for 5 minutes during configuration, the controller will automatically revert to the basic screen.

Airflow Direction

■ Configuring Airflow direction

Operation

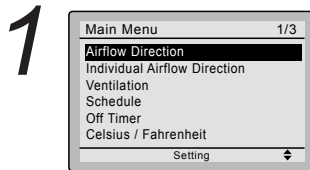

- Display the main menu screen. (See page 22.)
- Press ▼▲ buttons to select **Airflow Direction** and press **Menu/OK** button.

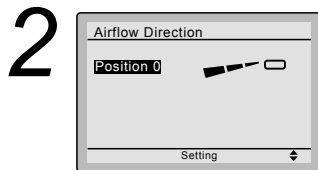
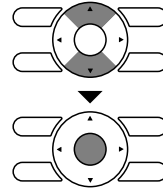

- (1) Adjusting method when there is single airflow direction.

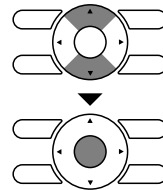

- Select the desired airflow direction from **Position 0** , **Position 1** , **Position 2** , **Position 3** , **Position 4** , **Swing** or **Auto** using ▼▲ buttons.
- Press **Menu/OK** button to confirm the settings and to return to the basic screen.

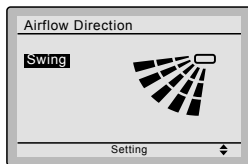

Airflow direction setting (up/down)

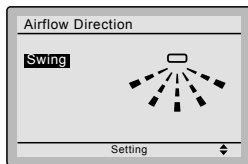

Airflow direction setting (left/right)

Note

- The airflow directions appear on the screen as follows:

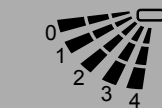

Up/down direction

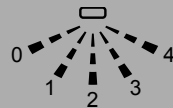

Left/right direction

- 0 : Position 0
- 1 : Position 1
- 2 : Position 2
- 3 : Position 3
- 4 : Position 4

Notice

These operation and screen are example of single airflow direction type indoor unit. It is different from Single flow cassette model.

Menu Options

3

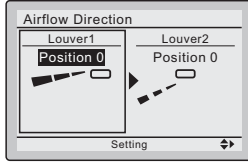

When front/back direction is selected

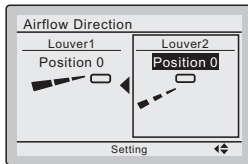

When left/right direction is selected

(2) Adjusting method for selecting dual airflow directions.

- Press ◀▶ buttons, to select front/back or left/right direction setting.



Notice

These operation and screen are example of dual airflow directions type indoor unit (Single flow cassette model).

4

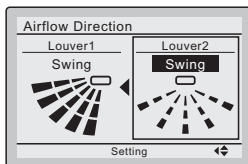
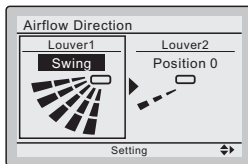
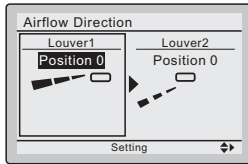

- Select the desired airflow direction from **Position 0** , **Position 1** , **Position 2** , **Position 3** , **Position 4** , **Swing** or **Auto** using ▼▲ buttons.

- Selecting **Swing** will cause the airflow direction louver to swing position 0 to 4.
- Setting **Auto** is not available when left/right direction is selected.

- Press **Menu/OK** button to confirm the settings and return to the basic screen.

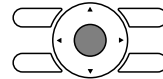
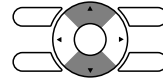

5

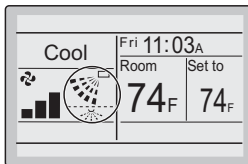

Basic screen (Detailed display)

- If dual airflow directions are set, then the dual airflow direction icons are displayed in the basic screen.

Individual Airflow Direction

■ Louver Setting

Operation

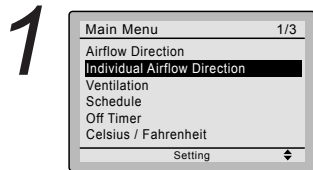

- Display the main menu screen. (See page 22.)
- Select **Individual Airflow Direction** and press **Menu/OK** button.

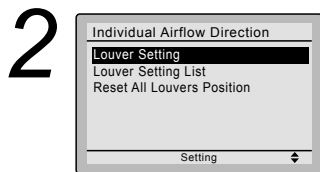
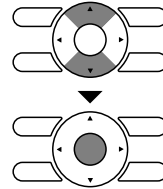

- Select **Louver Setting** and press **Menu/OK** button.

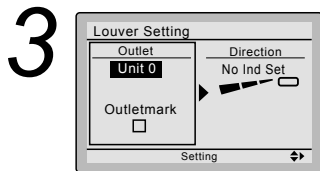
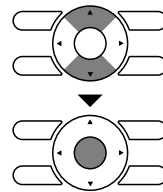

- Use ▼▲ buttons to select the unit and outlet mark.
- Maximum 16 units for each group (unit 0 till 15) can be selected.

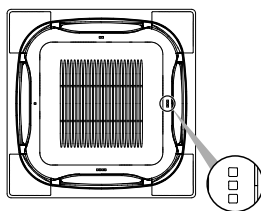
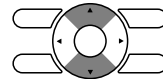

Note

In case of four outlets (cassette type), you can control each one of the four louvers individually (the following marks are beside each air outlet: □, □□, □□□, □□□□).

Menu Options

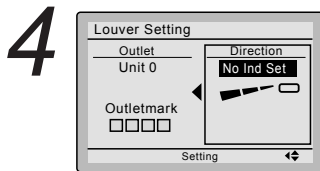

- Press ◀▶ button to select the airflow direction.
- Use ▼▲ buttons to change the airflow direction to the following:
No Ind Set , **Position 0** , **Position 1** , **Position 2** , **Position 3** , **Position 4** , **Swing** or **Blocked** .
No Ind Set : No Individual Louver Setting.
Blocked : Individual airflow is blocked.
- Press **Menu/OK** button to confirm the settings and to return to the basic screen.

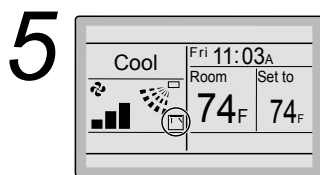
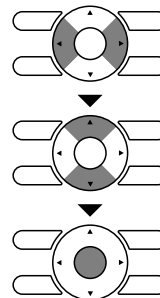

Basic screen
(Detailed display)

- If individual airflow direction is set, then the individual airflow direction icon is displayed in the basic screen.

■ Louver Setting List

Operation

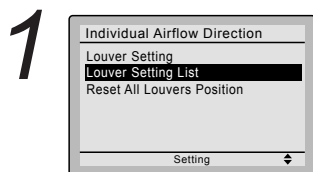

- Display the individual airflow direction screen. (See page 25.)
- Press ▼▲ buttons to select **Louver Setting List** and press **Menu/OK** button.

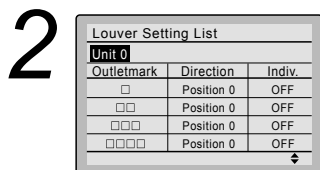
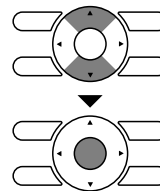

- A table shows the current settings. Press ▼▲ buttons to go to the next unit.
- Press **Cancel** button to return to the previous menu.

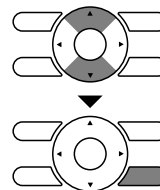

■ Reset All Louvers Position

Operation

1

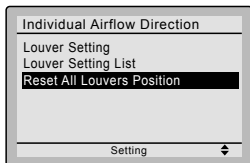

- Display the individual airflow direction screen.
(See page 25.)
- Press ▼▲ buttons to select **Reset All Louvers Position** and press **Menu/OK** button.

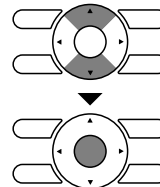

2

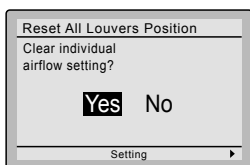

- Press ◀▶ buttons to select **Yes**.
- Press **Menu/OK** button to confirm the reset and to return to the basic screen.

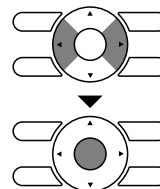

Operational Details and Functions

There are two types of airflow direction settings.

Airflow direction swing

The louvers automatically oscillate up and down.

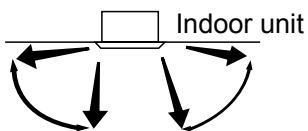

(Automatic swing)

(Automatic swing)

Airflow direction

You can select from one of five fixed directions. (This has no relation to the angle of the louvers.)

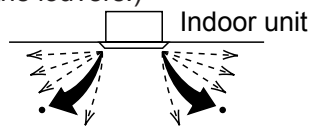

(Desired position)

(Desired position)

Movement of airflow direction louver

Under the operating conditions shown next, airflow direction is controlled automatically. Actual operation may be different than what is displayed on the remote controller.

Menu Options

Operating condition	<ul style="list-style-type: none"> • Room temperature is higher than the remote controller's setpoint (in heating operation). • When defrosting (in heating operation). (The airflow discharges horizontally to avoid creating a draft for the room occupants.) • Under continuous operation with the airflow discharging horizontally.
----------------------------	--

Ventilation

■ Ventilation screen display properties

Operation

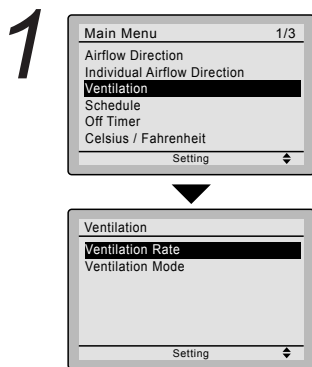

- 1 Display the main menu screen.
(See page 22.)
- Press ▼▲ buttons to select **Ventilation** on the main menu screen.
(For models with no ventilation function, **Ventilation** will not be displayed on the main menu screen.)
Press **Menu/OK** button to display the ventilation screen.

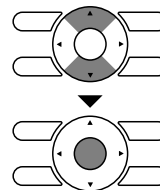

■ Changing the ventilation rate

Operation

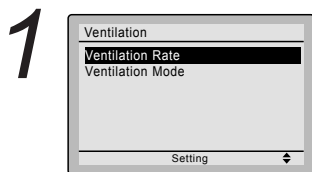

- 1 Navigate to the ventilation screen (see above).
- Press ▼▲ buttons to select **Ventilation Rate** on the ventilation screen.
Press **Menu/OK** button to display the ventilation rate screen.

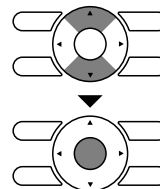

2



- Press ▼▲ buttons to toggle between the **Low** and **High** settings.

* Only modes that can be set are displayed.

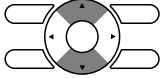

3

- Selecting and confirming the desired ventilation rate will take you back to the basic screen.
(Pressing **Cancel** button takes you back to the previous screen without changing the ventilation rate.)

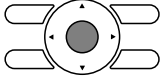

■ Changing the ventilation mode

Operation

1

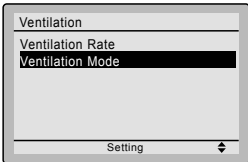

- Display the ventilation screen.
(See page 28.)
- Press ▼▲ buttons to select **Ventilation Mode** on the ventilation screen.
Press **Menu/OK** button to display the ventilation mode screen.

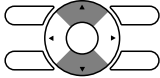
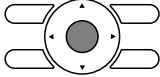
2

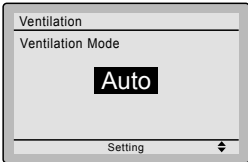

- Pressing ▼▲ buttons cycles through the settings in the order shown below.

→ **Auto** ↔ **ERV** ↔ **Bypass** ←

* Only modes that can be set are displayed.



Menu Options

3

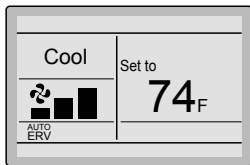

- Selecting and confirming the desired ventilation mode will take you back to the basic screen.
(Pressing **Cancel** button takes you back to the previous screen without changing the ventilation mode.)

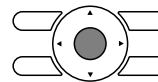

Ventilation Mode

Auto mode

Using information from the indoor unit (cool, heat, fan, and setpoint) and the energy recovery ventilator unit (indoor and outdoor temperatures), the ventilation mode is automatically changed between ERV and Bypass.

ERV mode

Outside air is passed through the ERV core and is supplied to the conditioned space.

Bypass mode

Outside air is supplied to the conditioned space without passing through the ERV core.

Schedule

■ Setting the schedule

Operation The schedule will disappear when a multizone controller is connected, but can be re-enabled by the system installer.

1

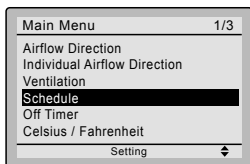

- Display the main menu screen.
(See page 22.)
- Press ▼▲ buttons to select **Schedule**.
Press **Menu/OK** button to display the schedule screen.

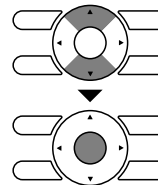

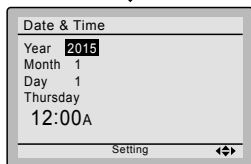
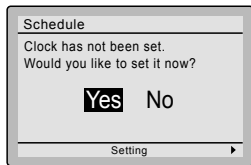

- Before setting the schedule, the clock must be set.
- If the clock has not been set, a screen like the one on the left will appear. Press ◀▶ buttons to select **Yes** and press **Menu/OK** button.
- The date & time screen will appear.
- Set the current year, month, day, and time. (See clock settings on page 42.)

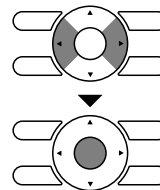

2

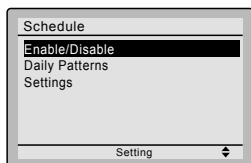

- Press ▼▲ buttons to select the desired function on the schedule screen and press **Menu/OK** button.

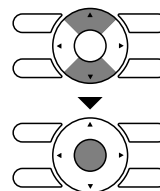

■ Daily Patterns

Operation

1

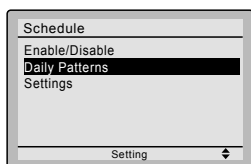

- The schedule screen will appear.
- Press ▼▲ buttons to select **Daily Patterns** on the schedule screen. The daily patterns screen will appear when **Menu/OK** button is pressed.

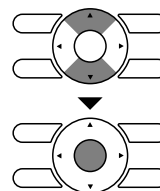

2

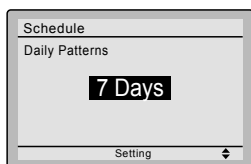

- Press ▼▲ buttons to select **7 Days**, **Weekday/Sat/Sun**, **Weekday/Weekend** or **Everyday** on the daily patterns screen. The confirmation screen will appear when **Menu/OK** button is pressed.

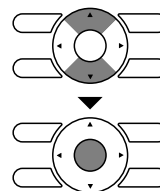

Menu Options

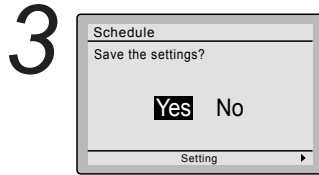

- Press ◀▶ buttons to select **Yes** on the confirmation screen.
- Pressing **Menu/OK** button enters the daily patterns in the schedule and takes you back to the main menu screen.

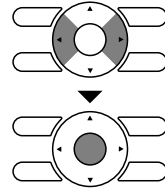

■Settings

Operation

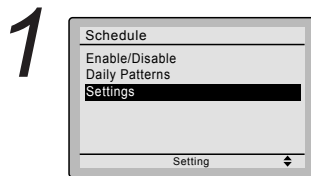

- The schedule screen will appear.
- Press ▼▲ buttons to select **Settings** on the schedule screen.
- The settings screen will appear when **Menu/OK** button is pressed.

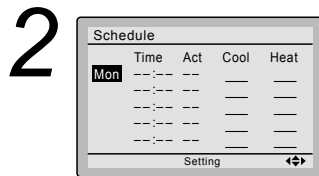
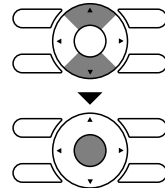

- Press ▼▲ buttons to select the day to be set.
- * It cannot be selected in the case of **EVDY**.

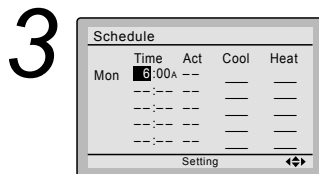
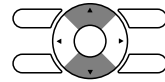

- Input the time for the selected day.
- Press ◀▶ buttons to move the highlighted item and press ▼▲ buttons to input the desired operation start time.
- Each press of ▼▲ buttons moves the numbers by 1 hour or 1 minute.

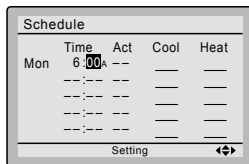
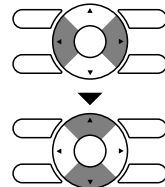

4

Schedule				
	Time	Act	Cool	Heat
Mon	6:00a	Act		
	---	---		
	---	---		
	---	---		
	---	---		
	---	---		
Setting ◀▶				

Schedule				
	Time	Act	Cool	Heat
Mon	6:00a	ON	90F	60F
	---	---		
	---	---		
	---	---		
	---	---		
	---	---		
Setting ◀▶				

- Press ◀▶ buttons to move the highlighted item and press ▼▲ buttons to configure ON/OFF/-- settings. --, ON, or OFF changes in sequence when ▼▲ buttons are pressed.

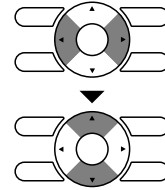

- ON: The temperature setpoints can be configured.
- OFF: The setback temperature setpoints can be configured.
- : The temperature setpoints and setback temperature setpoints become disabled.

Schedule				
	Time	Act	Cool	Heat
Mon	6:00a	ON	75F	70F
	8:00a	OFF	---	---
	---	---		
	---	---		
	---	---		
	---	---		
Setting ◀▶				

- The cooling and heating temperature setpoints for both ON and OFF (Setback) are configured.

- : Indicates that the temperature setpoint and setback temperature setpoint for this time period is not specified. The last active setpoint will be utilized.
- : Indicates that the setback function is disabled for this time period.

5

Schedule				
	Time	Act	Cool	Heat
Mon	6:00a	ON	75F	70F
	8:00a	OFF	85F	50F
	5:30p	ON	75F	70F
	10:00p	--		
	---	---		
	---	---		
Setting ◀▶				

Schedule				
	Time	Act	Cool	Heat
Mon	6:00a	ON	75F	70F
	8:00a	OFF	85F	50F
	5:30p	ON	75F	70F
	10:00p	OFF	82F	62F
	---	---		
	---	---		
Setting ◀▶				

Schedule				
	Time	Act	Cool	Heat
Tue	6:00a	ON	75F	70F
	8:00a	OFF	85F	50F
	5:30p	ON	75F	70F
	10:00p	OFF	82F	62F
	---	---		
	---	---		
Setting ◀▶				

A maximum of five actions per day can be set.

- Press **Menu/OK** button when settings for each day are completed. The confirmation screen will appear.

To copy the settings for the previous day, press **Mode** button so that the existing settings will be copied.

Example: The contents for Monday are copied by pressing **Mode** button after selecting Tuesday.

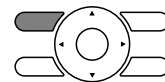
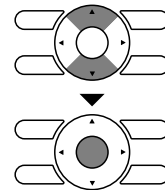

Menu Options

6

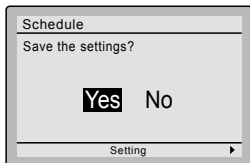

- Press ◀▶ buttons to select **Yes** on the confirmation screen. Pressing **Menu/OK** button confirms the settings for each day and takes you back to the basic screen.

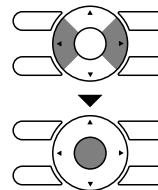

Enabling or disabling the schedule

Operation

1

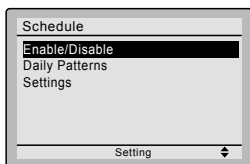

- Display the schedule screen. (See page 30.)
- Press ▼▲ buttons to select **Enable / Disable** on the schedule screen. Press **Menu/OK** button to display the enable/disable screen.

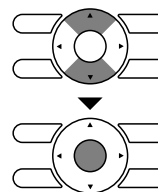

2

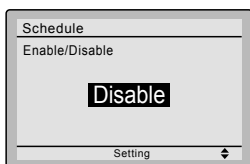

- Press ▼▲ buttons to select **Enable** or **Disable** on the enable/disable screen. Press **Menu/OK** button after selecting the item. The confirmation screen is displayed.

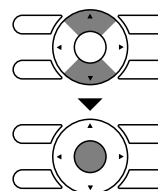

3

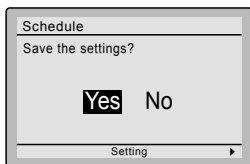

- Press ◀▶ buttons to select **Yes** on the confirmation screen. Pressing **Menu/OK** button confirms the enable/disable setting for the schedule and takes you back to the basic screen.

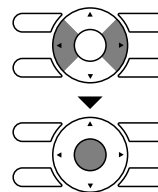

Off Timer

■ Configuring and Confirming the Off Timer settings

Operation

1

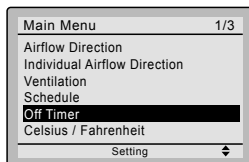

- Display the main menu screen.
(See page 22.)
- Press ▼▲ buttons to select the **Off Timer** on the main menu screen. Press **Menu/OK** button to display the off timer screen.

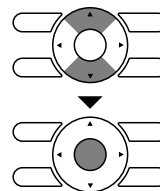

2

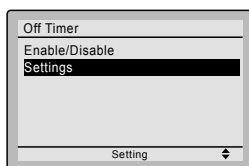

- Press ▼▲ buttons to select **Settings** on the off timer screen. Press **Menu/OK** button to display the configuration screen.

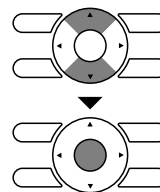

3

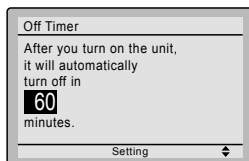

- Use ▼▲ buttons to set the time from operation start until the unit automatically stops. Selections can be made in increments of 10 minutes from 30 to 180 minutes. Holding down the button causes the number to change continuously.
- Select the desired time and press **Menu/OK** button. The confirmation screen will appear.

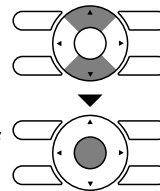

4

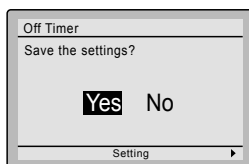

- Press ◀▶ button to select **Yes** on the confirmation screen. Pressing **Menu/OK** button confirms the off timer and takes you back to the basic screen.

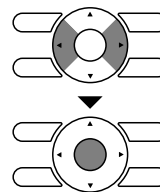

Menu Options



Enabling or disabling the off timer

Operation

1

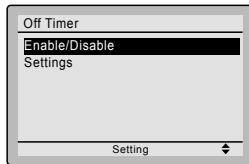

- Navigate to the off timer screen.
(See page 35.)
- Press ▼▲ buttons to select **Enable/Disable** on the off timer screen. Press **Menu/OK** button to display the enable/disable screen.

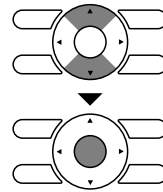

2

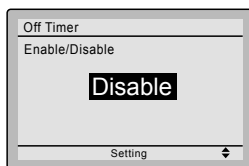

- Press ▼▲ buttons to select **Enable** or **Disable** on the enable/disable screen. Press **Menu/OK** button after selecting the item. Then the confirmation screen is displayed.

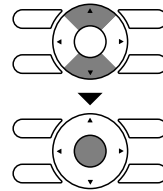

3

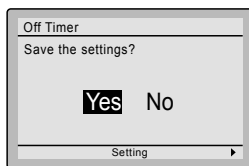

- Press ◀▶ button to select **Yes** on the confirmation screen. Pressing **Menu/OK** button confirms the enable/disable for the off timer and takes you back to the basic screen.

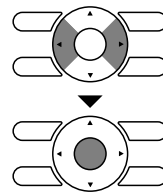

Maintenance Information

■ Displaying the service contact and model information

Operation

1

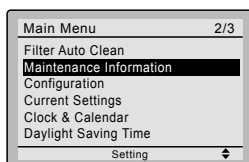

- Display the main menu screen.
(See page 22.)
- Press ▼▲ buttons to select **Maintenance Information** on the main menu screen and press **Menu/OK** button.

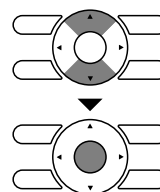

2

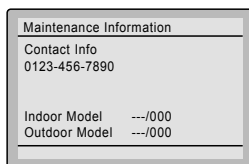

- The phone number for the contact is displayed at the top of the screen.
(If it has not yet been entered, it will not be displayed.)
- The model information of the indoor and outdoor units for your product will be displayed on the bottom of the screen.
(For some models the product code may be displayed.)

* The model name will not be displayed if the indoor unit PCB has been replaced.

* The error code history may also be displayed. If the Operation lamp is not flashing, the unit is working properly. The error code history is no longer displayed if you press **On/Off** button for more than 4 seconds.



Menu Options

Configuration

■ Draft Prevention

Operation

1

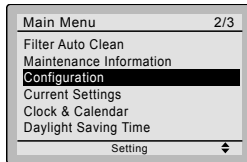

- Display the main menu screen.
(See page 22.)
- Press ▼▲ buttons to select **Configuration** and press **Menu/OK** button.

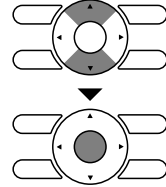

2

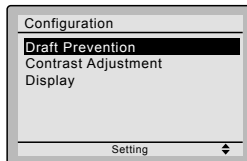

- Press ▼▲ buttons to select **Draft Prevention** and press **Menu/OK** button.

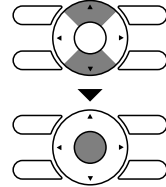

3

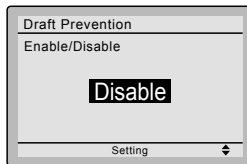

- Press ▼▲ buttons to select **Enable** or **Disable**.
- The confirmation screen will appear when **Menu/OK** button is pressed.

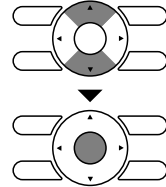

4

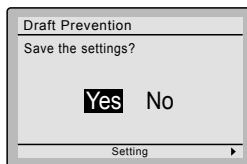

- Press ◀▶ buttons to select **Yes**.
- Press **Menu/OK** button to confirm the settings and to return to the basic screen.

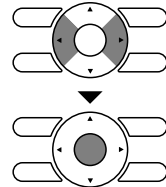

■ Contrast Adjustment

Operation

1

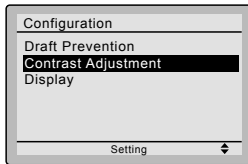

- Navigate to the configuration screen. (See page 38.)
- Press ▼▲ buttons to select **Contrast Adjustment** on the configuration screen. Press **Menu/OK** button to display the contrast adjustment screen.

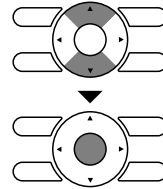

2

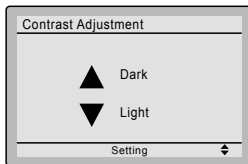

- On the contrast adjustment screen press ▼▲ buttons until you reach the desired contrast. After setting, press **Menu/OK** button and return to the basic screen.

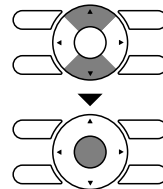

Menu Options

■ Display Display Mode

Operation

1

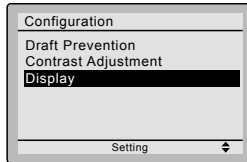

- Navigate to the configuration screen.
(See page 38.)
- Press ▼▲ buttons to select **Display** on the configuration screen. Press **Menu/OK** button to display the display screen.

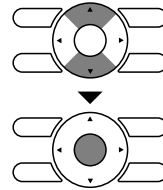

2

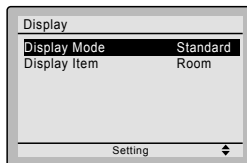

- Press ▼▲ buttons to select **Display Mode** on the display screen. Press **Menu/OK** button to display the display mode screen.

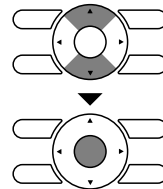

3

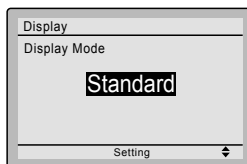

- Press ▼▲ buttons to select **Standard**, **Detailed** or **Simple** on the display screen.
- Press **Menu/OK** button to confirm the settings and return to the basic screen.

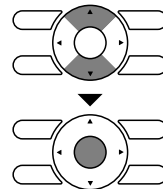

* Refer to **Display Item** to change the selectable display item for Detailed and Simple display modes. (See page 41.)

Display Item

Operation

1

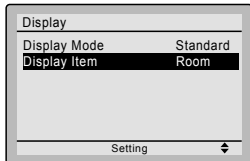

- Navigate to the display screen.
(See page 40.)
- Press ▼▲ buttons to select **Display Item** on the display screen. Press **Menu/OK** button to display the display item screen.

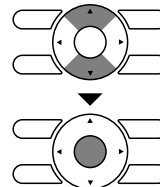

2

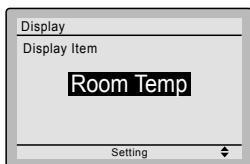

- Pressing ▼▲ buttons displays the following.



* Some models may not display these items even if they are selected.

- Be sure to read the following notes regarding display of room temperature and outside air temperature.

Room Temp

..... The temperature at the remote controller.
The temperature that is detected may be affected by the location of the remote controller.

Outside Air Temp

..... The temperature at the outdoor unit.
The temperature that is detected may be affected by factors such as the location of the unit (for example, if it is in direct sunlight) and unit operation during defrosting.

- After setting, press **Menu/OK** button to confirm settings and return to the basic screen.



Menu Options

Current Settings

Confirming the current settings

Operation

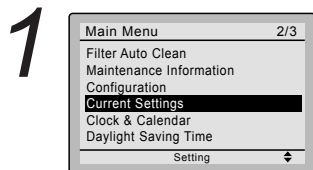

- Display the main menu screen. (See page 22.)
- Press ▼▲ buttons to select **Current Settings** on the main menu screen and press **Menu/OK** button.

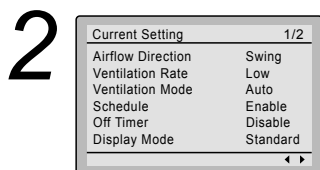
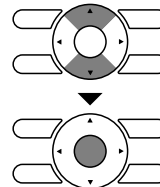

- A list showing the current setting status will appear. Press ◀▶ buttons to go to the next item.
- Pressing **Cancel** button takes you back to the main menu screen.

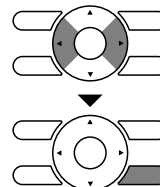

Display items	
Airflow Direction	Off Timer
Ventilation Rate	Display Mode
Ventilation Mode	Display Item
Schedule	Filter Auto Clean

* Display items may differ depending on the model. Only the items that can be set are displayed.

Clock & Calendar

Date & Time

Operation

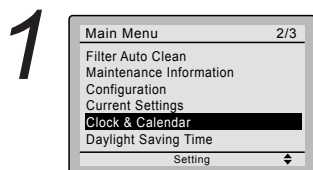

- Display the main menu screen. (See page 22.)
- Press ▼▲ buttons to select **Clock & Calendar** on the main menu screen. Press **Menu/OK** button to display the clock & calendar screen.

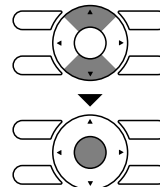

2

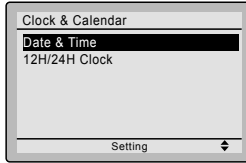

- Press ▼▲ buttons to select **Date & Time** on the clock & calendar screen. Press **Menu/OK** button to display the date & time screen.

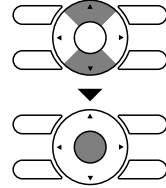

3

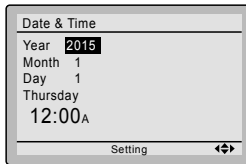

- Select **Year** with ◀▶ buttons. Change the year with ▼▲ buttons. Holding down the button causes the number to change continuously.

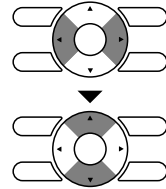

4

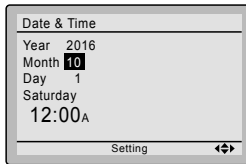

- Select **Month** with ◀▶ buttons. Change the month with ▼▲ buttons. Holding down the button causes the number to change continuously.

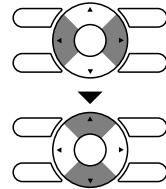

5

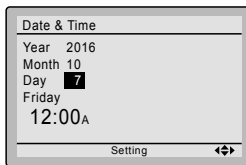

- Select **Day** with ◀▶ buttons. Change the day with ▼▲ buttons. Holding down the button causes the number to change continuously. Days of the week change automatically.

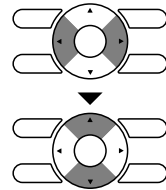

6

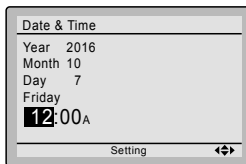

- Select **Hour** with ◀▶ buttons. Change the hour with ▼▲ buttons. Holding down the button causes the number to change continuously.

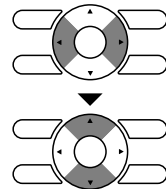

Menu Options

7

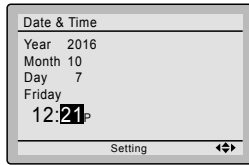

- Select **Minute** with ◀▶ buttons.
Change the minute with ▼▲ buttons. Holding down the button causes the number to change continuously.
- Press **Menu/OK** button.
The confirmation screen will appear.

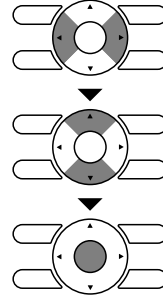

Note: _____

The date can be set between
January 1, 2015 and December 31, 2099.

8

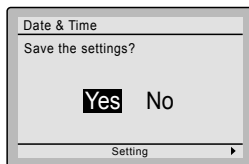

- Press ◀▶ button to select **Yes** on the confirmation screen.
Press **Menu/OK** button to confirm the clock and return to the basic screen.

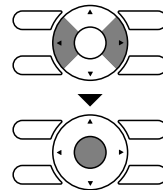

* When setting the schedule, the display returns to the settings screen.

■ 12H/24H CLOCK

Operation

1

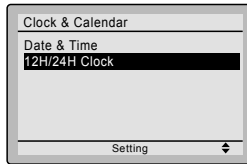

- Display the clock & calendar screen. (See page 42.)
- Press ▼▲ buttons to select **12H/24H Clock** on the clock & calendar screen. The 12H/24H clock screen will appear when **Menu/OK** button is pressed.

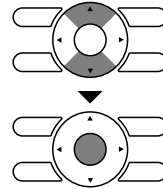

2

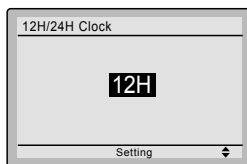

- By default, the time display is set to the 12H format.
- Press ▼▲ buttons to select **12H** **24H** on the 12H/24H clock screen.
- The confirmation screen will appear when **Menu/OK** button is pressed.

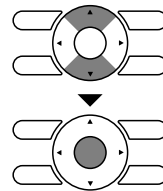

3

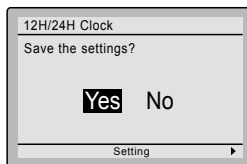

- Press ◀▶ buttons to select **Yes** on the confirmation screen. Pressing **Menu/OK** button confirms the 12H or 24H and takes you back to the basic screen.

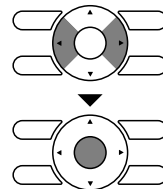

Daylight Saving Time

■ How to display Daylight Saving Time

Operation

1

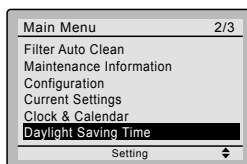

- Display the main menu screen. (See page 22.)
- Press ▼▲ buttons to select **Daylight Saving Time** on the main menu screen. Press **Menu/OK** button to display the daylight saving time screen.

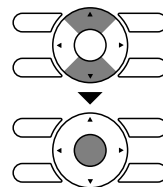

Menu Options

Enabling or disabling Daylight Saving Time

Operation

1

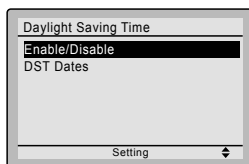

- Display the daylight saving time screen.
(See page 45.)
- Press ▼▲ buttons to select **Enable/Disable** on the daylight saving time screen. Press **Menu/OK** button to display the enable/disable screen.

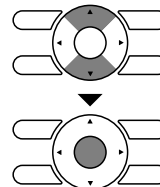

2



- Press ▼▲ buttons to select **Enable** or **Disable** on the enable/disable screen.
- Press **Menu/OK** button to display the setting confirmation screen.

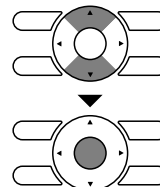

3

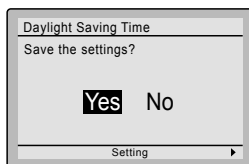

- Press ◀▶ buttons to select **Yes** on the setting confirmation screen. Pressing **Menu/OK** button confirms the daylight saving time enable/disable setting and takes you back to the basic screen.

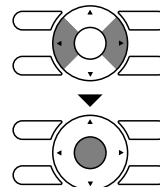

Setting the date

Operation

1

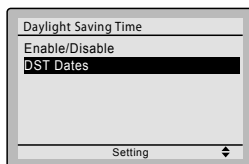

- Display the daylight saving time screen.
(See page 45.)
- Press ▼▲ buttons to select **DST Dates** on the daylight saving time screen. Press **Menu/OK** button to display the duration setting screen.

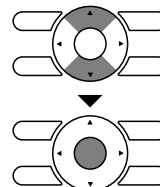

2

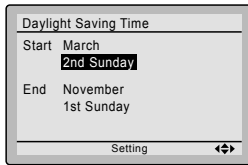
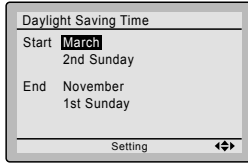

- Press ▼▲ buttons to select the start month and the end month.
- Press ◀▶ buttons to select a week. Press ▼▲ buttons to select the start week and the end week.
- After setting the Start and End dates, press **Menu/OK** button to display the setting confirmation screen.

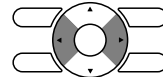

3

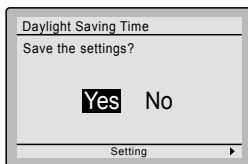

- Press ◀▶ buttons to select **Yes** on the setting confirmation screen. Pressing **Menu/OK** button confirms the Daylight Saving Time settings and takes you back to the basic screen.



When Daylight Saving Time is enabled

When the time in the remote controller reaches 2:00 a.m. on the specified start date, the clock is automatically set forward by one hour. When the time in the remote controller reaches 2:00 a.m. on the end date, the clock is automatically set back by one hour.

Menu Options

Language

■ Selectable Languages

Operation

1

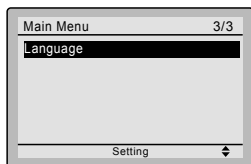

- Display the main menu screen. (See page 22.)
- Press ▼▲ buttons to select **Language** on the main menu screen and press **Menu/OK** button.

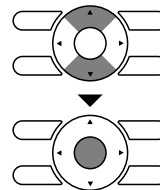

2



- Press ▼▲ buttons to select the preferred language on the language screen. **English/Français/Español** are available.
- Press **Menu/OK** button to confirm the settings and return to the basic screen.

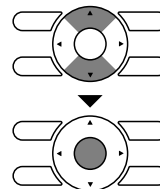

Maintenance

Reset Filter Indicator

Operation

1

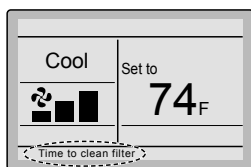

- When it is time to clean or replace the filter, one of the following messages will be displayed on the bottom of the basic screen.

Time to clean filter

Time to clean filter & element

Time to clean element

* This is not displayed when Simple display is set.

- Wash, clean, or replace the filter or element.
For details, refer to the operation manual supplied with the indoor unit.

2

- Reset the filter indicator when the filter or element is cleaned or replaced.
- Press **Menu/OK** button.
The main menu screen will be displayed.

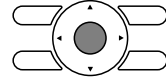

3

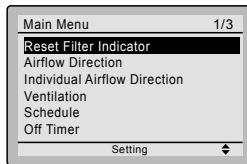

- Press ▼▲ buttons to select **Reset Filter Indicator** on the main menu screen and press **Menu/OK** button.

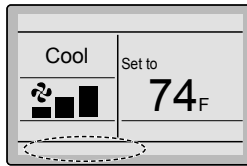
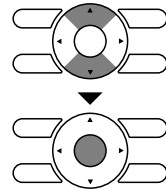

- The displayed message “Time to clean filter” is no longer displayed on the basic screen when the filter sign is reset.

Maintaining the Unit and LCD Display

- Wipe the LCD and surface of the remote controller with a dry cloth when they become dirty.
- If the dirt on the surface cannot be removed, soak the cloth in neutral detergent diluted with water, squeeze the cloth tightly, and clean the surface. Wipe the surface with a dry cloth.

Note

- Do not use any paint thinner, organic solvent, or strong acid.

Reference Information

Error Code Display

■ Contact your Daikin dealer in the following cases

Operation

1

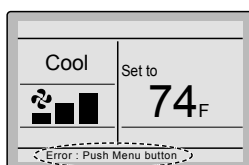

- If an error occurs, either one of the following items will flash in the basic screen.

Error: Push Menu button

- * The Operation lamp will flash.
- * For Simple display, the message is not displayed, and only the Operation lamp flashes.

Warning: Push Menu button

- * The Operation lamp will not flash.
- * For Simple display, the message is not displayed, and the Operation lamp does not flash, either.

- Press **Menu/OK** button.

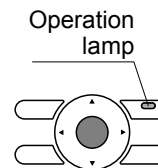

2

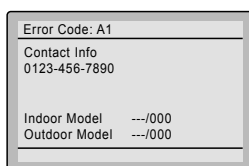

- The error code will flash and the service contact and model name or code may be displayed.
- Notify your Daikin dealer of the Error code and model name or code.

After-sale Service

Warning

- **Do not relocate or reinstall the remote controller by yourself.**
Improper installation may result in electric shocks or fire.
Consult your Daikin dealer.



■ Advise your Daikin Dealer of the following items

- Model name
- Date of installation
- Failure conditions: As precise as possible.
- Your address, name, and telephone number

■ Repairs after Warranty Period

Consult your Daikin dealer.

■ Inquiry about After-sale Service

Contact your Daikin dealer.

2.7 BRC082A43 for CDMQ, FDMQ

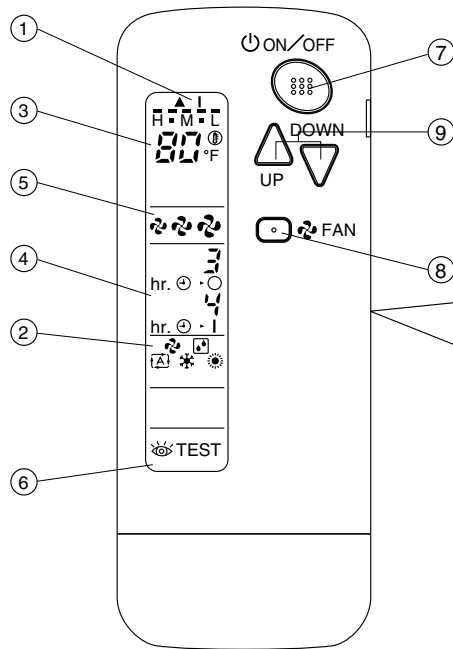

Fig. 1-1

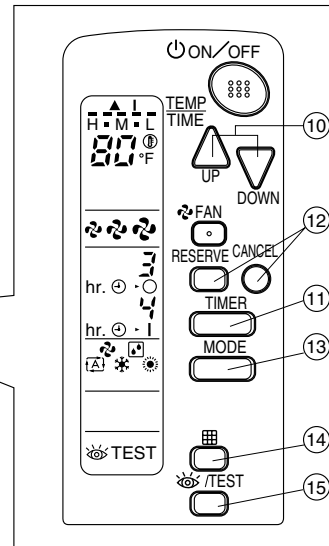

Fig. 1-2

The situation which opened the front cover of the remote control

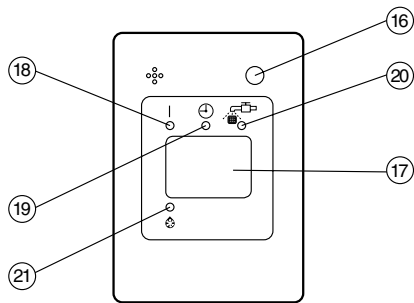

Fig. 1-3

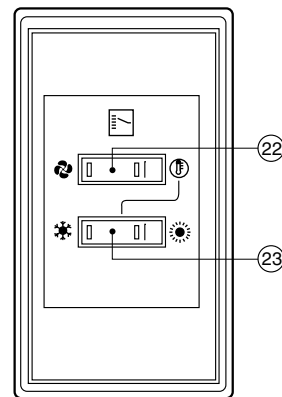

Fig. 2

COOL/HEAT CHANGEOVER
REMOTE CONTROL SWITCH

- Not necessary to use with some of our product types.

CONTENTS

ILLUSTRATIONS3
 1. SAFETY CONSIDERATIONS4
 2. NAMES AND FUNCTIONS OF THE OPERATING SECTION4
 3. HANDLING FOR WIRELESS REMOTE CONTROLLER.....5
 4. OPERATION PROCEDURE6
 5. NOT MALFUNCTION OF THE AIR CONDITIONER9
 6. HOW TO DIAGNOSE TROUBLE SPOTS.....9

1. SAFETY CONSIDERATIONS

Please read these "SAFETY CONSIDERATIONS" carefully before installing air conditioning equipment and be sure to install it correctly. After completing the installation, make sure that the unit operates properly during the start-up operation. Please instruct the customer on how to operate the unit and keep it maintained.

Also, inform customers that they should store this operation manual along with the installation manual for future reference. This air conditioner comes under the term "appliances not accessible to the general public".

Meaning of warning, caution and note symbols.

⚠ WARNING Indication a potentially hazardous situation which, if not avoided, could result in death or serious injury.

⚠ CAUTION Indication a potentially hazardous situation which, if not avoided, may result in minor or moderate injury. It may also be sued to alert against unsafe practices.

⚠ NOTE.....Indication situation that may result in equipment or property-damage-only accidents.

Keep these warning sheets handy so that you can refer to them if needed.

Also, if this equipment is transferred to a new user, make sure to hand over this operation manual to the new user.

⚠ WARNING

- **It is not good for your health to expose your body to the air flow for a long time.**
- **In order to avoid electric shock, fire or injury, or if you detect any abnormality such as smell of fire, turn off power and call your dealer for instructions.**
- **Ask your dealer for installation of the air conditioner.** Incomplete installation performed by yourself may result in a water leakage, electric shock, and fire.
- **Ask your dealer for improvement, repair, and maintenance.** Incomplete improvement, repair, and maintenance may result in a water leakage, electric shock, and fire.
- **Do not put a finger, a rod or other objects into the air inlet or outlet. As the fan is rotating at high speed, it will cause injury.**
- **Ask your dealer to move and reinstall the air conditioner.** Incomplete installation may result in a water leakage, electric shock, and fire.





- **Do not touch the switch with wet fingers.**
Touching a switch with wet fingers can cause electric shock.
- **Do not operate the air conditioner with a wet hand.**
Otherwise, you could receive an electric shock.

⚠ CAUTION

- **Do not use the air conditioner for other purposes.**
In order to avoid any quality deterioration, do not use the unit for cooling precision instruments, food, plants, animals or works of art.
- **To avoid oxygen deficiency, ventilate the room sufficiently if equipment with burner is used together with the air conditioner.**
- **Do not allow a child to mount on the unit or avoid placing any object on it.**
Falling or tumbling may result in injury.
- **Do not let children play on and around the unit.**
If they touch the unit carelessly, it may result in injury.
- **Do not place a flower vase and anything containing water.**
Water may enter the unit, causing an electric shock or fire.
- **Do not operate the air conditioner when using a room fumigation - type insecticide.**
Failure to observe could cause the chemicals to become deposited in the unit, which could endanger the health of those who are hypersensitive to chemicals.
- **Never use flammable spray such as hair spray, lacquer or paint near the unit.**
It may cause a fire.

2. NAMES AND FUNCTIONS OF THE OPERATING SECTION (Fig. 1-1~3, 2)

1	DISPLAY "▲" "I" (SIGNAL TRANSMISSION) This lights up when a signal is being transmitted.
2	DISPLAY "🌀" "🌞" "🌧" "🌬" "🌡" "🌡" "🌡" (OPERATION MODE) This display shows the current OPERATION MODE. For VRV system, "🌡" is not installed.
3	DISPLAY "TEMP" "OFF" (SET TEMPERATURE) This display shows the set temperature.
4	DISPLAY "hr. ⓪ 3 hr. ⓪ 4" (PROGRAMMED TIME) This display shows PROGRAMMED TIME of the system start or stop.
5	DISPLAY "🌀" "🌀" "🌀" (FAN SPEED) This display shows the set fan speed.
6	DISPLAY "🔍 TEST" (INSPECTION/ TEST OPERATION) When the INSPECTION/TEST OPERATION BUTTON is pressed, the display shows the system mode is in.
7	ON/OFF BUTTON Press the button and the system will start. Press the button again and the system will stop.

8	FAN SPEED CONTROL BUTTON Press this button to select the fan speed, HIGH, MEDIUM or LOW, of your choice.
9	TEMPERATURE SETTING BUTTON Use this button for SETTING TEMPERATURE. (Operates with the front cover of the remote controller closed.)
10	PROGRAMMING TIMER BUTTON Use this button for programming "START and/or STOP" time. (Operates with the front cover of the remote controller opened.)
11	TIMER MODE START/STOP BUTTON Refer to page 7.
12	TIMER RESERVE/CANCEL BUTTON Refer to page 7.
13	OPERATION MODE SELECTOR BUTTON Press this button to select OPERATION MODE.
14	FILTER SIGN RESET BUTTON Refer to the section of MAINTENANCE in the operation manual attached to the indoor unit.
15	INSPECTION/TEST OPERATION BUTTON This button is pressed for inspection or test operation. Do not use for normal operation.
16	EMERGENCY OPERATION SWITCH This switch is readily used if the remote controller does not work.
17	RECEIVER This receives the signals from the remote controller.
18	OPERATING INDICATOR LAMP (Red) This lamp stays lit while the air conditioner runs. It flashes when the unit is in trouble.
19	TIMER INDICATOR LAMP (Green) This lamp stays lit while the timer is set.
20	AIR FILTER CLEANING TIME INDICATOR LAMP (Red) Lights up when it is time to clean the air filter.
21	DEFROST LAMP (Orange) Lights up when the defrosting operation has started. (For cooling only type this lamp does not turn on.)
22	FAN/AIR CONDITIONING SELECTOR SWITCH Set the switch to "  " (FAN) for FAN and "  " (A/C) for HEAT or COOL.
23	COOL/HEAT CHANGEVER SWITCH Set the switch to "  " (COOL) for COOL and "  " (HEAT) for HEAT.

⚠ NOTE

- For the sake of explanation, all indications are shown on the display in Fig. 1-1 contrary to actual running situations.
- Fig. 1-2 shows the remote controller with the front cover opened.
- Fig. 2 shows this remote controller can be used in conjunction with the one provided with the VRV system.
- If the air filter cleaning time indicator lamp lights up, clean the air filter as explained in the operation manual provided with the indoor unit.
After cleaning and reinstalling the air filter, press the filter sign reset button on the remote controller. The air filter cleaning time indicator lamp on the receiver will go out.
- The DEFROST lamp will flash when the power is turned on. This is not a malfunction.

3. HANDLING FOR WIRELESS REMOTE CONTROLLER

- **Precautions in handling remote controller**
- **Direct the transmitting part of the remote controller to the receiving part of the air conditioner.**
If something blocks the transmitting and receiving path of the indoor unit and the remote controller as curtains, it will not operate.

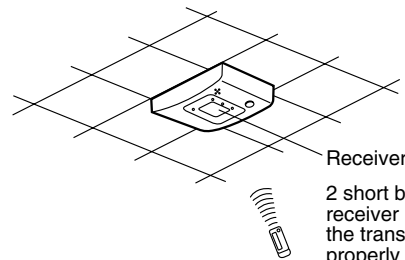

- **Transmitting distance is approximately 23 ft..**
- **Do not drop or get it wet.**
It may be damaged.
- **Never press the button of the remote controller with a hard, pointed object.**
The remote controller may be damaged.
- **Installation site**
It is possible that signals will not be received in rooms that have electronic fluorescent lighting. Please consult with the salesman before buying new fluorescent lights.
If the remote controller operated some other electrical apparatus, move that machine away or consult your dealer.

Placing the remote controller in the remote controller holder

Install the remote controller holder to a wall or a pillar with the attached screw. (Make sure it transmits.)

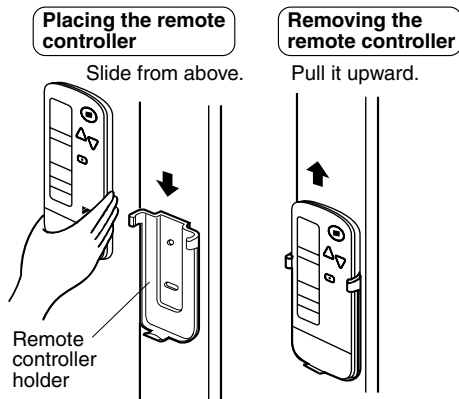

How to put the dry cell batteries

- (1) Remove the back cover of the remote controller to the direction pointed by the arrow mark.
- (2) Put the dry cell batteries. Use two LR03<AM4> dry cell batteries. Put the dry cell batteries correctly to fit their (+) and (-).
- (3) Close the back cover as before.

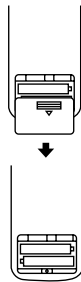

When to change batteries

Under normal use, batteries last about 1 year. However, change them whenever the indoor unit doesn't respond or responds slowly to commands, or if the display becomes dark.

CAUTION

- Replace all batteries at the same time, do not use new and old batteries intermixed.
- In case the remote controller is not used for a long time take out all batteries in order to prevent liquid leak of the battery.

IN THE CASE OF CENTRALIZED CONTROL SYSTEM

If the indoor unit is under centralized control, it is necessary to switch the remote controller's setting. In this case, contact your dealer.

4. OPERATION PROCEDURE

- Contact your dealer to confirm your system type.
- To protect the unit, turn on the main power switch 6 hours before operation.
- If the main power supply is turned off during operation, operation will restart automatically after the power turns back on again.

COOLING, HEATING, AUTOMATIC, FAN, AND PROGRAM DRY OPERATION

Operate in the following order.

- AUTOMATIC OPERATION can be selected only by Heat pump system or Heat recovery system.

<<(FOR SYSTEMS WITHOUT COOL/HEAT CHANGEOVER REMOTE CONTROL SWITCH (Fig. 1-1~2 on page 3))>>

1 OPERATION MODE SELECTOR

Press OPERATION MODE SELECTOR button several times and select the OPERATION MODE of your choice as follows.

- COOLING OPERATION “❄️”
- HEATING OPERATION “☀️”
- AUTOMATIC OPERATION “🔄”
 - In this operation mode, COOL/HEAT changeover is automatically conducted.
 - For VRV system, “🔄” is not installed.
- FAN OPERATION “🌀”
- DRY OPERATION “💧”
 - The function of this program is to decrease the humidity in your room with the minimum temperature decrease.
 - The microchip automatically determines TEMPERATURE and FAN SPEED.
 - This system does not go into operation if the room temperature is below 60°F.

2 ON/OFF

Press ON/OFF button.

OPERATING INDICATOR lamp lights up or goes off and the system starts or stops OPERATION.

NOTE

- Do not turn off power immediately after the unit stops. Then, wait no less than 5 minutes. Water is leaking or there is something else wrong with the unit.

<<(FOR SYSTEMS WITH COOL/HEAT CHANGEOVER REMOTE CONTROL SWITCH (Fig. 2 on page 3))>>

1 OPERATION MODE SELECTOR

(1) Select OPERATION MODE with the COOL/HEAT CHANGEOVER REMOTE CONTROL SWITCH as follows.

- COOLING OPERATION “❄️”
- HEATING OPERATION “☀️”
- FAN OPERATION “🌀”
- DRY OPERATION “💧”

- See “FOR SYSTEM WITHOUT COOL/HEAT CHANGEOVER REMOTE CONTROL SWITCH” for details on dry operation.

- (2) Press **OPERATION MODE SELECTOR** button several times and select “”.
(This operation is only available during dry operation.)



Press ON/OFF button.

OPERATING INDICATOR lamp lights up or goes off and the system starts or stops OPERATION.



- Do not turn off power immediately after the unit stops. Then, wait no less than 5 minutes.
Water is leaking or there is something else wrong with the unit.

[EXPLANATION OF HEATING OPERATION]

DEFROST OPERATION

- As the frost on the coil of an outdoor unit increase, heating effect decreases and the system goes into DEFROST OPERATION.
- The fan operation stops and the DEFROST lamp of the indoor unit goes on.
- After 6 to 8 minutes (maximum 10 minutes) of DEFROST OPERATION, the system returns to HEATING OPERATION.

Heating capacity & Outdoor air temperature



- Heating capacity drops as outdoor air temperature lowers.
If feeling cold, use another heater at the same time as this air conditioner.
- Hot air is circulated to warm the room. It will take some time from when the air conditioner is first started until the entire room becomes warm. The internal fan automatically turns at low speed until the air conditioner reaches a certain temperature on the inside. In this situation, all you can do is wait.
- If hot air accumulates on the ceiling and feet are left feeling cold, it is recommended to use a circulator. For details, contact the place of purchase.

ADJUSTMENT



For programming TEMPERATURE and FAN SPEED, follow the procedure shown below.



Press TEMPERATURE SETTING button and program the setting temperature.

-  Each time this button is pressed, setting temperature rises 1°F.
-  Each time this button is pressed, setting temperature lowers 1°F.

In case of automatic operation

-  Each time this button is pressed, setting temperature shifts to “H” side.
-  Each time this button is pressed, setting temperature shifts to “L” side.

[°F]

	H	•	M	•	L
Setting temperature	77	73	71	70	66

- The setting is impossible for fan operation.



- The setting temperature range of the remote controller is 60°F to 90°F.



FAN SPEED CONTROL

Press FAN SPEED CONTROL button.

High, Medium or Low fan speed can be selected.
The microchip may sometimes control the fan speed in order to protect the unit.

PROGRAM TIMER OPERATION

Operate in the following order.

- The timer is operated in the following 2 ways.
Programming the stop time (⊕ · ○)
.... The system stops operating after the set time has elapsed.
Programming the start time (⊕ · |)
.... The system starts operating after the set time has elapsed.
- The timer can be programmed a maximum of 72 hours.
- The start and the stop time can be simultaneously programmed.



Press the TIMER MODE START/STOP button several times and select the mode on the display.



The display flashes.

For setting the timer stop “⊕ · ○”

For setting the timer start “⊕ · |”



Press the PROGRAMMING TIMER button and set the time for stopping or starting the system.

-  When this button is pressed, the time advances by 1 hour.
-  When this button is pressed, the time goes backward by 1 hour.



Press the TIMER RESERVE button.

The timer setting procedure ends.

The display changes from flashing light to a constant light.



Press the TIMER CANCEL button to cancel programming.

The display vanishes.

For example.

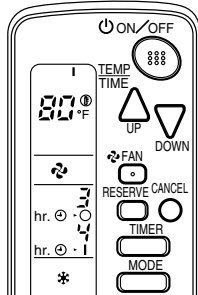

When the timer is programmed to stop the system after 3 hours and start the system after 4 hours, the system will stop after 3 hours and then 1 hour later the system will start.

NOTE

- After the timer is programmed, the display shows the remaining time.

HOW TO SET MASTER REMOTE CONTROLLER (For VRV system)

- When the system is installed as shown below, it is necessary to designate the master remote controller.

■ For Heat pump system

When 1 outdoor unit is connected with several indoor units.

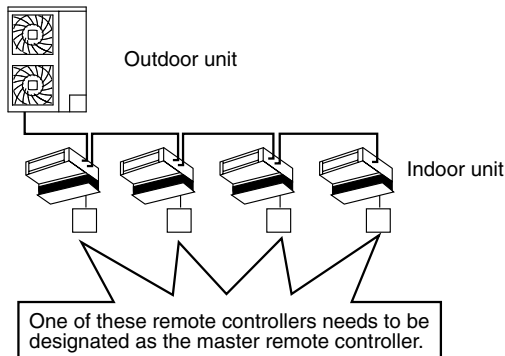

■ For Heat recovery system

When 1 BS unit is connected with several indoor units.

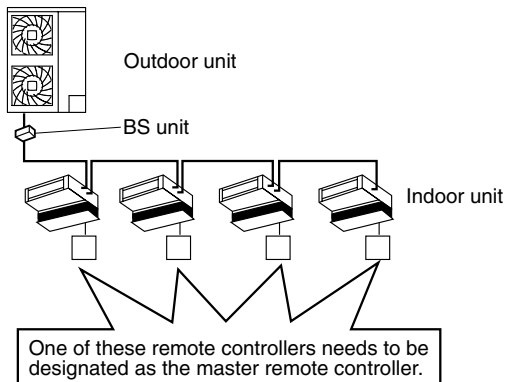

- Only the master remote controller can select HEATING, COOLING or AUTOMATIC OPERATION.

When the indoor unit with master remote controller is set to “COOL”, you can switch over operation mode between “FAN”, “DRY” and “COOL”.

When the indoor unit with master remote controller is set to “HEAT”, you can switch over operation mode between “FAN” and “HEAT”.

When the indoor unit with master remote controller is set to “FAN”, you cannot switch operation mode.

1 long beep When attempting settings than that consented above.

Only with Heat recovery system, you can set the indoor unit to AUTOMATIC. Attempting to do so.

How to designate the master remote controller

Operate in the following order.



Continuously press the OPERATION MODE SELECTOR button for 4 seconds.

The displays showing “ ⊕ ” of all slave indoor unit connected to the same outdoor unit or BS unit flash.



Press the OPERATION MODE SELECTOR button to the indoor unit that you wish to designate as the master remote controller. Then designation is completed. This indoor unit is designated as the master remote controller and the display showing “ ⊕ ” vanishes.

- To change settings, repeat steps ① and ②.

EMERGENCY OPERATION

When the remote controller does not work due to battery failure or the absence there of, use this switch which is located beside the discharge grille on the indoor unit. When the remote controller does not work, but the battery low indicator on it is not lit, contact your dealer.

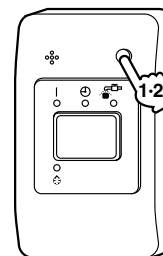

[START]

1 Press the EMERGENCY OPERATION switch.

The machine runs in the previous mode.

[STOP]

2 Press the EMERGENCY OPERATION switch again.

PRECAUTIONS FOR GROUP CONTROL SYSTEM OR 2 REMOTE CONTROLLERS CONTROL SYSTEM

This system provides 2 other control systems beside individual control (1 remote controller controls 1 indoor unit) system. Confirm the following if your unit is of the following control system type.

■ Group control system

- 1 remote controller controls up to 16 indoor units.
All indoor units are equally set.

■ 2 remote controllers control system

- 2 remote controllers control 1 indoor unit.
(In case of group control system, 1 group of indoor units)
The unit follows individual operation.

⚠ NOTE

- Cannot have 2 remote controllers control system with only wireless remote controllers. (It will be a 2 remote controllers control system having 1 wired and 1 wireless remote controllers.)
- Under 2 remote controllers control system, wireless remote controller cannot control timer operation.
- Only the operating indicator lamp out of 3 other lamps on the indoor unit display functions.
- Contact your dealer in case of changing the combination or setting of group control and 2 remote controllers control systems.

5. NOT MALFUNCTION OF THE AIR CONDITIONER

The following symptoms do not indicate air conditioner malfunction.

■ THE SYSTEM DOES NOT OPERATE

- The system does not restart immediately after the ON/OFF button is pressed.**
If the OPERATING INDICATOR lamp lights, the system is in normal condition. It does not restart immediately because a safety device operates to prevent overload of the system. After 3 minutes, the system will turn on again automatically.
- The system does not restart immediately when TEMPERATURE SETTING button is returned to the former position after pushing the button.**
It does not restart immediately because a safety device operates to prevent overload of the system. After 3 minutes, the system will turn on again automatically.
- If the reception beep is rapidly repeated 3 times. (It sounds only 2 times when operating normally.)**
Control is set to the optional controller for centralized control.
- If the DEFROST lamp on the indoor unit's display is lit when heating is started.**
This indication is to warn against cold air being blown from the unit. There is nothing wrong with the equipment.
- The unit stops operation from time to time.**
- With "U4" "U5" displayed on the remote controller, the unit stops, but it resumes operation in a few minutes.**
Since electric noises produced from other equipment than the air conditioner interrupt communication between the units, the unit stops operation.
If these electric noises subside, operation is restarted automatically.
- COOLING / HEATING changeover is impossible.**
- If the indoor unit emits a receiving sound "1 long beep".**
It is because the indoor unit under the control of operation changeover is set to the mode that cannot be selected.

■ Display Indicates only a part.

- Even if the unit is in operation, the display shows only operational indication. Even if the indication is shown, the indication other than operation disappears after a while.**
It is because the remote controller is set to multi-system.

■ Display disappears or shows all indication.

- It happens when the button of the remote controller is pressed.**
It is because the battery is dead.

■ No favorable cooling is achieved.

- The unit is in DRY OPERATION.**
DRY OPERATION is carried out to perform operation such that the room temperature is not decreased as much as possible.

6. HOW TO DIAGNOSE TROUBLE SPOTS

■ EMERGENCY STOP

When the air conditioner stops in emergency, the run lamp on the indoor unit starts blinking. Take the following steps yourself to read the malfunction code that appears on the display. Contact your dealer with this code. It will help pinpoint the cause of the trouble, speeding up the repair.

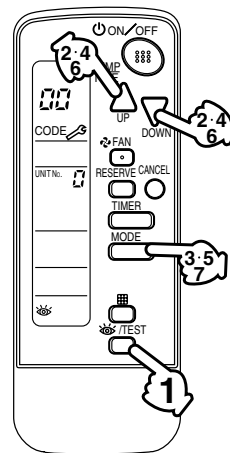

Press the INSPECTION/TEST OPERATION button to select the inspection mode "⏏".

"⏏" appears on display and blinks. "UNIT No." lights up.



Press PROGRAMMING TIMER button and change the unit number.

Press to change the unit number until the indoor unit beeps and perform the following operation according to the number of beeps.

Number of beeps

3 short beeps..... Perform all steps from ③ to ⑥.

1 short beep..... Perform ③ and ⑥ steps.

1 long beep..... Normal state



Press OPERATION MODE SELECTOR button.

"" on the left-hand of the malfunction code blinks.



Press PROGRAMMING TIMER button and change the malfunction code.

Press until the indoor unit 2 beeps.



Press OPERATION MODE SELECTOR button.

"" on the right-hand of the malfunction code blinks.



Press PROGRAMMING TIMER button and change the malfunction code.

Press until the indoor unit makes 1 long beep.

The malfunction code is fixed when the indoor unit makes 1 long beep.



Reset of the display

Press OPERATION MODE SELECTOR button to get the display back to the normal state.

■ IN CASE BESIDES EMERGENCY STOP

- The unit does not operate at all.
 - Check if the receiver is exposed of sunlight or strong light. Keep receiver away from light.
 - Check if there are batteries in the remote controller. Place the batteries.
 - Check if the indoor unit number and wireless remote controller number are equal.

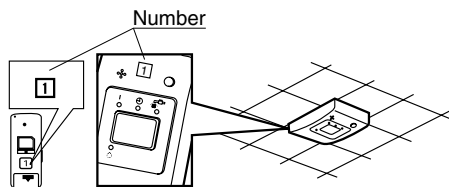

Operate the indoor unit with the remote controller of the same number.

Signal transmitted from 1 remote controller of a different number cannot be accepted. (If the number is not mentioned, it is considered as "1".)

■ The system operates but it does not sufficiently cool or heat.

- If the set temperature is not proper. (See page 7)
- If the FAN SPEED is set to LOW SPEED. (See page 7)

Contact the place of purchase in the following case.

⚠ WARNING

When you detect a burning odor, shut OFF power immediately and contact the place of purchase. Using the equipment in anything but proper working condition can result in equipment damage, electric shock or fire.

[Trouble]

- The OPERATING INDICATOR lamp of the indoor unit is flashing and the unit does not work at all.

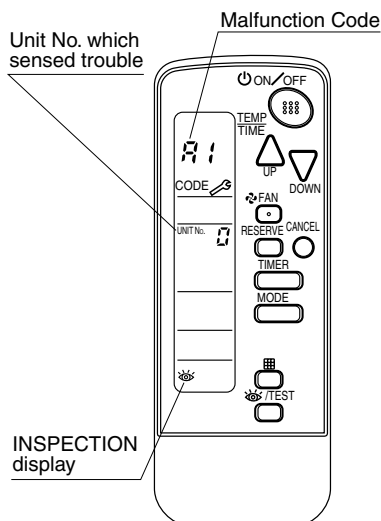

Check the malfunction code (A1 - UF) on the remote controller and contact the place of purchase. (Refer to indoor unit installation manual.)

2.8 BRC082A41W, BRC982A42W(S) for FFQ

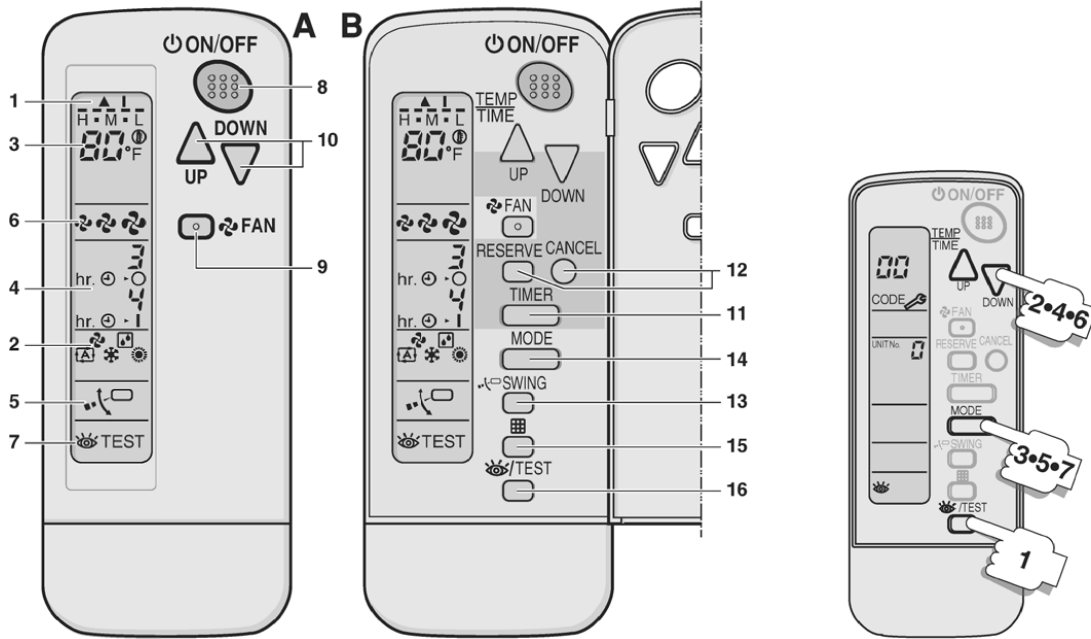

Figure 1

Figure 2

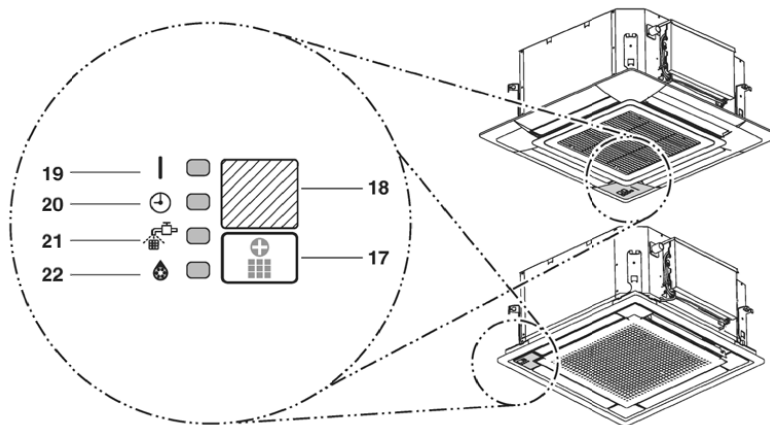

Figure 3

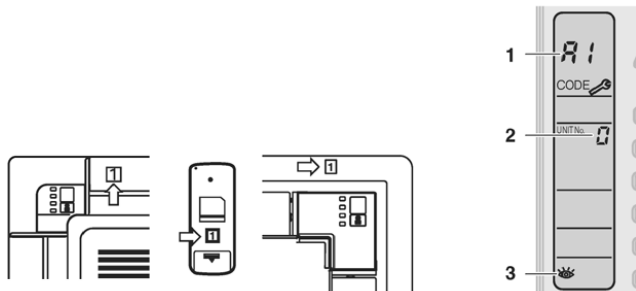

Figure 4

Figure 5

Contents

Safety considerations	1
Names and functions of the operating section	2
Handling for wireless remote controller	3
Precautions in handling remote controller.....	3
Installation site	3
Placing the remote controller in the remote controller holder.....	3
How to put the batteries	3
When to change batteries	3
In case of a centralized control system	3
Operation range	4
Operation procedure	4
COOLING, HEATING, AUTOMATIC, FAN and DRY operation	4
Adjustment	5
Program timer operation	6
Emergency operation.....	6
Precautions for group control system or two remote control system.....	6
Troubleshooting	7
Emergency stop	7
In case besides emergency stop	7
When you think there is something wrong ...	8



Thank you for purchasing this Daikin remote controller. Carefully read this operation manual before using the air conditioner. It will tell you how to use the unit properly and help you if any trouble occurs. After reading the manual, file it away for future reference.

The English text is the original instruction. Other languages are translations of the original instructions.

Safety considerations

To gain full advantage of the air conditioner's functions and to avoid malfunction due to mishandling, we recommend that you read this instruction manual carefully before use. The precautions described herein are classified as WARNING and CAUTION. They both contain important information regarding safety. Be sure to observe all precautions without fail.



WARNING
Failure to follow these instructions properly may result in personal injury or loss of life.

CAUTION
Failure to observe these instructions properly may result in property damage or personal injury, which may be serious depending on the circumstances.

Information classified as **NOTE** contains instructions to ensure proper use of the equipment. After reading, keep this manual in a convenient place so that you can refer to it whenever necessary. If the equipment is transferred to a new user, be sure also to hand over the manual.



WARNING

- Be aware that prolonged, direct exposure to cool or warm air from the air conditioner, or to air that is too cool or too warm can be harmful to your physical condition and health.
- When the air conditioner is malfunctioning (giving off a burning odor, etc.) turn off power to the unit and contact your local dealer. Continued operation under such circumstances may result in a failure, electric shock or fire hazards.
- Do not attempt to install or repair the air conditioner yourself. Improper workmanship may result in water leakage, electric shock or fire hazards. Please contact your local dealer or qualified personnel for installation and maintenance work.
- Ask your dealer to perform servicing or repairs whenever necessary. Improper servicing or repairs may result in water leaks, electric shock or fire.
- Do not place objects, including rods, your fingers, etc., in the air inlet or outlet. Injury may result due to contact with the air conditioner's highspeed fan blades.
- Consult your local dealer regarding relocation and reinstallation of the air conditioner. Improper installation work may result in leakage, electric shock or fire hazards.

















CAUTION

- Do not use the air conditioner for purposes other than those for which it is intended. Do not use the air conditioner for cooling precision instruments, food, plants, animals or works of art as this may adversely affect the performance, quality and/or longevity of the object concerned.
- To avoid oxygen depletion, ensure that the room is adequately ventilated if equipment such as a burner is used together with the air conditioner.
- Do not expose plants or animals directly to air flow from the unit as this may cause adverse effects.
- To avoid electric shock, do not operate with wet hands.
- Do not place burners or heaters in places exposed to the air flow from the unit as this may impair combustion of the burner or heater.
- Do not place flammable sprays or operate spray containers near the unit as this may result in fire.

Names and functions of the operating section

See figure 1, (figure 1B shows the remote controller with front cover opened)

- 1 DISPLAY “▲” (SIGNAL TRANSMISSION)
This lights up when a signal is being transmitted.
- 2 DISPLAY “ “ “ “ “” (OPERATION MODE)
This display shows the current OPERATION MODE.
- 3 DISPLAY “ “” (SET TEMPERATURE)
This display shows the set temperature.
- 4 DISPLAY “hr.  hr. ” (PROGRAMMED TIME)
This display shows PROGRAMMED TIME of the system start or stop.
- 5 DISPLAY “ “” (SWING FLAP)
Refer to “AIR FLOW DIRECTION ADJUST” on page 5.
- 6 DISPLAY “ “ “” (FAN SPEED)
The display shows the set fan speed.
- 7 DISPLAY “ TEST” (INSPECTION/TEST OPERATION)
When the INSPECTION/TEST OPERATION BUTTON is pressed, the display shows the system mode is in.
- 8 ON/OFF BUTTON
Press the button and the system will start. Press the button again and the system will stop.
- 9 FAN SPEED CONTROL BUTTON
Press this button to select the fan speed, LOW, MEDIUM or HIGH, of your choice.
- 10 TEMPERATURE SETTING BUTTON
Use this button for SETTING TEMPERATURE.
- 11 TIMER MODE START/STOP BUTTON
Refer to “TIMER MODE START/STOP” on page 6.
- 12 TIMER RESERVE/CANCEL BUTTON
Refer to “PROGRAMMING TIME” on page 6.
- 13 AIR FLOW DIRECTION ADJUST BUTTON
Refer to “AIR FLOW DIRECTION ADJUST” on page 5.
- 14 OPERATION MODE SELECTOR BUTTON
Press this button to select OPERATION MODE.
- 15 FILTER SIGN RESET BUTTON
Refer to the section of MAINTENANCE in the operation manual attached to the indoor unit.
- 16 INSPECTION/TEST OPERATION BUTTON
This button is used only by qualified service persons for maintenance purposes.

See figure 3, (receiver on decoration panel)

- 17 EMERGENCY OPERATION SWITCH
This switch is readily used if the remote controller does not work.
- 18 RECEIVER
This receives the signals from the remote controller.
- 19 OPERATION LAMP (Red)
This lamp stays lit while the air conditioner runs. It blinks when the unit is in trouble.
- 20 TIMER LAMP (Green)
This lamp stays lit while the timer is set.
- 21 AIR FILTER CLEANING TIME INDICATOR LAMP (Red)
Lights up when it is time to clean the air filter.
- 22 DEFROST LAMP (Orange)
Lights up when the defrosting operation has started.

NOTE



- For the sake of explanation, all indications are shown on the display in figure 1 contrary to actual running situations.
- If the AIR FILTER CLEANING TIME INDICATOR lamp lights up, clean the air filter as explained in the operation manual provided with the indoor unit.
After cleaning and reattaching the air filter, press the FILTER SIGN RESET button on the remote controller. The AIR FILTER CLEANING TIME INDICATOR lamp on the receiver will go out.
- The DEFROST lamp will blink when the power is turned on. This is not a malfunction.

Handling for wireless remote controller

Precautions in handling remote controller

- Direct the transmitting part of the remote controller to the receiving part of the air conditioner.
- If something blocks the transmitting and receiving path of the indoor unit and the remote controller such as curtains, it will not operate.

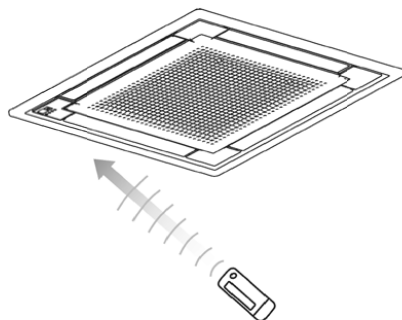

- Transmitting distance is approximately 23ft (7m).
- 2 short beeps from the receiver indicates that the transmission is properly done.
- Do not drop or get it wet. It may get damaged.
- Never press the button of the remote controller with a hard, pointed object. The remote controller may get damaged.

Installation site

- It is possible that signals will not be received in rooms that have electronic fluorescent lighting. Please consult with the salesman before buying new fluorescent lights.
- If the remote controller operated some other electrical apparatus, move that machine away or consult your dealer.

Placing the remote controller in the remote controller holder

Choose a place where the signals reach the unit.
Install the remote controller holder to a wall or a pillar with the attached screw.

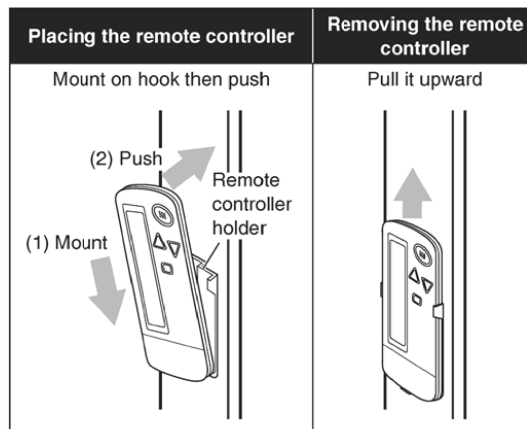

How to put the batteries

- 1 Slide the back cover to take it off.

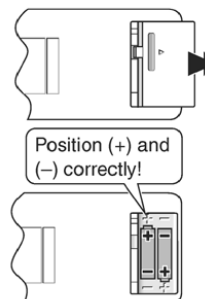

- 2 Insert 2 dry batteries AAA, LR03 (alkaline).

- 3 Replace the back cover.

When to change batteries

Under normal use, batteries last about a year. However, if the remote controller display begins to fade and the possible transmission range becomes shorter within a year, replace both batteries as specified above.

NOTE  Replace the two batteries at the same time, do not use new and old batteries intermixed. In case the remote controller is not used for a long time, take out all batteries in order to prevent liquid leak of the battery.

In case of a centralized control system

If the indoor unit is under centralized control, it is necessary to switch the remote controller's setting. In this case, contact your dealer.

Operation range

- Refer to the operation manual provided with the indoor unit or with the outdoor unit.
- If the indoor temperature or humidity is beyond operating conditions as listed in the indoor unit or outdoor unit manuals, it may happen
 - that safety devices work,
 - that the air conditioner does not operate,
 - that water drips from the indoor unit.
- The setting temperature range of the remote controller is 60°F (16°C) to 90°F (32°C).

Operation procedure

- If the main power supply is turned off during operation, operation will restart automatically after the power turns back on again.

COOLING, HEATING, AUTOMATIC, FAN and DRY operation

Operate in the following order:

AUTOMATIC operation can be selected only by heat pump system.

For systems without a cool/heat changeover remote control switch

1 OPERATION MODE SELECTOR

See figure 1

Press the OPERATION MODE SELECTOR button several times and select the OPERATION MODE of your choice as follows:

- COOLING operation ❄️
- HEATING operation ☀️
- AUTOMATIC operation 🔄
 - In this operation mode, COOL/HEAT changeover is automatically conducted.
- FAN operation 🌀
- DRY operation 🧊
 - This operation is to decrease the humidity in your room with the minimum temperature decrease.
 - The set point is the air temperature when starting operation by DRY operation.
 - Micro computer automatically determines TEMPERATURE and FAN SPEED.
 - DRY operation will not activate when room temperature is 57°F (14°C) or less.

2



ON/OFF

Press ON/OFF button.

The OPERATION lamp lights up or goes off and the system starts or stops operation.



Do not turn OFF power immediately after the unit stops. Wait at least 5 minutes. Failure to do so may result in water leakage etc.

Explanation of HEATING operation DEFROST operation

- As the frost on the coil of an outdoor unit increase, heating effect decreases and the system goes into DEFROST operation.
- The FAN operation stops and the DEFROST lamp of the indoor unit goes on.
After about 4 to 12 minutes of DEFROST operation, the system returns to HEATING operation.

Heating capacity and outdoor air temperature

- Heating capacity drops as outdoor air temperature lowers. If feeling cold, use another heater at the same time with this air conditioner.
- Hot air is circulated to warm the room. It will take some time from when the air conditioner is first started until the entire room becomes warm. The internal fan automatically turns at low speed until the air conditioner reaches a certain temperature on the inside.
- If hot air accumulates on the ceiling and feet are left feeling cold, it is recommended to use a circulator. For details, contact the place of purchase.

Adjustment

For programming TEMPERATURE, FAN SPEED and AIR FLOW DIRECTION, follow the procedure shown below.



TEMPERATURE SETTING

Press TEMPERATURE SETTING button and program the setting temperature.



UP

Each time this button is pressed, setting temperature rises 1°F (0.56°C).



DOWN

Each time this button is pressed, setting temperature lowers 1°F (0.56°C).

In case of AUTOMATIC operation



UP

Each time this button is pressed, setting temperature shifts to "H" side.



DOWN

Each time this button is pressed, setting temperature shifts to "L" side.

°F(°C)

	H	•	M	•	L
Setting temperature	77 (25)	73 (23)	71.5 (22)	70 (21)	66 (19)

• The setting is impossible for FAN operation

- The setting temperature range of the remote controller is 60°F (16°C) to 90°F (32°C).



FAN SPEED CONTROL

Press FAN SPEED CONTROL button.

- LOW, MEDIUM or HIGH fan speed can be selected.
- The micro computer may sometimes control the fan speed in order to protect the unit.



AIR FLOW DIRECTION ADJUST

The movable limit of the flap is changeable. Contact your dealer for details.

- Up and down adjustment

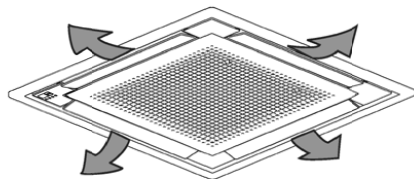

Press the AIR FLOW DIRECTION ADJUST button to select the air direction as shown below.



Display appears and the air flow direction continuously varies. (Automatic swing setting.)

Press AIR FLOW DIRECTION ADJUST button to select the air direction of your choice.

Display vanishes and the air flow direction is fixed. (Fixed air flow direction setting.)

■ Movement of the swing flap

For the following conditions, the micro computer controls the air flow direction so it may be different from the display.

Operation mode	HEATING
Operation conditions	<ul style="list-style-type: none"> ■ When starting operation. ■ When room temperature is higher than the set temperature. ■ In DEFROST operation. (The flaps turn to the horizontal position to avoid blowing cold air directly on the occupants of the room.)

NOTE

- Operation mode includes AUTOMATIC operation.

Program timer operation

Operate in the following order.

- The timer is operated in the following two ways:
 - Programming the stop time (⊕ ▶ ○).
The system stops operating after the set time has elapsed.
 - Programming the start time (⊕ ▶ |).
The system starts operating after the set time has elapsed.
- The timer can be programmed for a maximum of 72 hours.
- The start and the stop time can be simultaneously programmed.

1 TIMER MODE START/STOP

Press the TIMER MODE START/STOP button several times and select the mode on the display. The display blinks.

- For setting the timer stop ⊕ ▶ ○
- For setting the timer start ⊕ ▶ |

2 PROGRAMMING TIME

Press the TEMPERATURE SETTING button and set the time for stopping or starting the system.



When this button is pressed, the time advances by 1 hour.



When this button is pressed, the time goes backward by 1 hour.

3 TIMER RESERVE

Press the TIMER RESERVE button.

- The timer setting procedure ends.
- The display changes from blinking light to a constant light.

4 TIMER CANCEL

Press the TIMER CANCEL button to cancel programming. The display vanishes.

For example.

When the timer is programmed to stop the system after 3 hours and start the system after 4 hours, the system will stop after 3 hours and then 1 hour later the system will start.

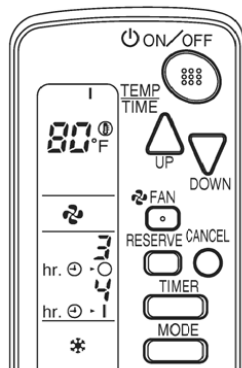

NOTE  After the timer is programmed, the display shows the remaining time.

Emergency operation

When the remote controller does not work due to battery failure or the absence thereof, use the switch which is located beside the discharge grille on the indoor unit. When the remote controller does not work, contact your dealer.

1 START

Press the emergency operation switch.

- The unit runs in the previous mode.
- The system operates with the previously set air flow direction.

2 STOP

Press the emergency operation switch again.

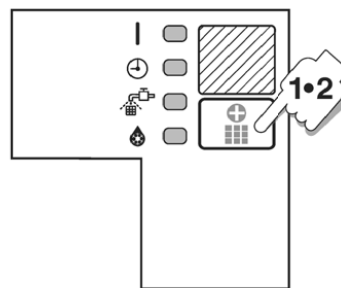

Precautions for group control system or two remote control system

This system provides two other control systems beside individual control (one remote controller controls one indoor unit) system. Confirm the following if your unit is of the following control system type:

- Group control system
One remote controller controls up to 16 indoor units. All indoor units are equally set.
- Two remote controller control system
Two remote controllers control one indoor unit. (In case of group control system, one group of indoor units.) The unit follows individual operation.

- NOTE** 
- Cannot have a two remote controller control system with only wireless remote controllers. (It will be a two remote controller control system having one wired remote controller and one wireless remote controller.)
 - Under two remote controller control system, wireless remote controller cannot control timer operation.
 - Only the OPERATION lamp out of 3 other lamps on the indoor unit display functions. Contact your dealer in case of changing the combination or setting of group control and two remote controller control systems.

Troubleshooting

Emergency stop

(See figure 2)

When the air conditioner stops unexpectedly, the OPERATION lamp on the indoor unit starts blinking. Take the following steps yourself to read the malfunction code that appears on the display. Contact your dealer with this code. It will help pinpoint the cause of the trouble and speeding up the repair.

1



Press the INSPECTION/TEST button to select the inspection mode.
"UNIT No." lights up and the unit number "U" blinks.

2



Press the TEMPERATURE SETTING button and change the unit number.
Hold down the TEMPERATURE SETTING button until the indoor unit emits one of the following beep tones.

Number of beeps

- 3 short beeps perform all steps from 3 to 6
- 1 short beep perform steps 3 and 6
- 1 long beep No trouble

3



Press the OPERATION MODE SELECTOR button.
"U" on the left-hand of the malfunction code blinks.

4



Press the TEMPERATURE SETTING button and change the malfunction code.
Press until the indoor unit makes 2 short beeps.

5



Press the OPERATION MODE SELECTOR button.
"U" on the right-hand of the malfunction code blinks.

6



Press the TEMPERATURE SETTING button and change the malfunction code.
Press until the indoor unit makes a long beep.
The malfunction code is fixed when the indoor unit makes a long beep.

7



Reset of the display.

Press OPERATION MODE SELECTOR button to get the display back to its normal state.

In case besides emergency stop

- 1 The unit does not operate at all.
 - Check if the receiver is exposed of sunlight or strong light. Keep receiver away from light.
 - Check if there are batteries in the remote controller. Place the batteries.
 - Check if the indoor unit number and wireless remote controller number are equal. See figure 4. Operate the indoor unit with the remote controller of the same number.
Signals transmitted from a remote controller of a different number cannot be accepted. (If the number is not mentioned, it is considered as "1".)
- 2 The system operates but it does not sufficiently cool or warm.
 - Check if the set temperature is proper.
 - Check if the FAN SPEED is not set to LOW SPEED.
 - Check if the air flow angle is proper.
 Contact the place of purchase in the following case.



When you detect a burning odor, shut OFF power immediately and contact the place of purchase. Using the equipment in anything but proper working condition can result in equipment damage, electric shock and/or fire.

Trouble

The OPERATION lamp of the indoor unit is blinking and the unit does not work at all. See figure 5.

- 1 Malfunction code
- 2 Unit No. which sensed trouble
- 3 INSPECTION display

Remedial action

Check the malfunction code (E1-E5) on the remote controller. Notify and inform the model name and what the malfunction code indicates to your dealer.

When you think there is something wrong

The following symptoms do not indicate air conditioner malfunction:

Symptom 1: The system does not operate

Example	Reason
The system does not restart immediately after the ON/OFF button is pressed.	If the OPERATION lamp lights, the system is in normal condition. It does not restart immediately because a safety device operates to prevent overload of the system. After 3 minutes, the system will turn on again automatically.
If operation stops as a result of changing the temperature setting, there will be a delay before operation restarts if the setting is lowered (in COOLING) or raised (in HEATING) again.	It does not restart immediately because a safety device operates to prevent overload of the system. After 3 minutes, the system will turn on again automatically.
If the reception beep is rapidly repeated 3 times (It sounds only twice when operating normally.)	Control is set to the optional controller for centralized control.
If the DEFROST lamp on the indoor unit's display is lit when heating is started.	This indication is to warn against cold air being blown from the unit. There is nothing wrong with the equipment.
The outdoor unit stops.	Because the room temperature reaches to the set temperature. The indoor unit goes into FAN operation.

Symptom 2: The unit stops once in a while

Example	Reason
The remote controller indicates "u" and "u5", the unit stops. Within several minutes the unit restarts.	Due to electrical noise other than that from the air conditioner, the communication between the units is cut off and the unit stops. When the noise is gone, the unit automatically restarts.

Symptom 3: No changeover is available between HEATING and COOLING modes

Example	Reason
The indoor unit makes a long beep sound.	When operation changeover is under control, the control is set to the mode that cannot be carried out.

Symptom 4: Air flow rate cannot be obtained as set

Example	Reason
During HEATING operation, even if the FAN SPEED CONTROL button is pressed, the air flow rate does not change.	When the room temperature reaches the indoor unit set temperature, the outdoor unit stops and the air flow rate of indoor unit drops to the minimum. This is to avoid the cold air from getting in contact with the people in the room.

Symptom 5: Air discharge direction is not as set

Example	Reason
The remote controller indication and the air discharge direction is not the same. Air discharge direction swing is impossible.	Because it is controlled by microcomputer. Refer to "AIR FLOW DIRECTION ADJUST" on page 5.

Symptom 6: Only a part of indication shows

Example	Reason
Even if the unit is operated, only the operation indication shows, or even if the indication shows, soon after, the indication other than that for operation disappears.	The corresponding indoor unit is that for multi-system and the remote controller is set to the multi-system.

Symptom 7: No indication shows or all indication show

Example	Reason
When the remote controller button is pressed.	The battery is dead.

Symptom 8: Insufficient cooling

Example	Reason
It is in DRY operation.	The DRY operation is an operation mode trying to keep the room temperature constant as much as possible. Refer to "COOLING, HEATING, AUTOMATIC, FAN and DRY operation" on page 4.

Part 4 Options

1. Options List.....	457
1.1 Indoor Unit	457
1.2 Outdoor Unit	459
2. Control Devices	460
2.1 <BRC944B2> Wired Remote Controller (Installation)	460
2.2 <BRC944B2> Wired Remote Controller (Operation).....	462
2.3 <BRCW901A03/08> Wired Remote Controller Cord.....	474
2.4 <KRP413BB1S> Wiring Adaptor	475
2.5 <DCS302C71> Central Remote Controller (Installation)	479
2.6 <DCS302C71> Central Remote Controller (Operation)	484
2.7 <DCS301C71> Unified ON/OFF Controller (Installation)	510
2.8 <DCS301C71> Unified ON/OFF Controller (Operation).....	515
2.9 <DST301BA61> Schedule Timer Controller (Installation)	517
2.10 <DST301BA61> Schedule Timer Controller (Operation).....	522
2.11 <KRP928BB2S> Interface Adaptor for DIII-NET.....	535
2.12 <KRP1C74/75> Wiring Adaptor.....	538
2.13 <KRP4A74> Wiring Adaptor	539
2.14 <KRP4A98> Installation Box for Adaptor PCB	544
2.15 <KRP1BA101> Installation Box for Adaptor PCB.....	546
2.16 <KRCS01-4B> Remote Sensor	548
3. Indoor Unit.....	551
3.1 <BRYQ60A2W(S)> Sensor Kit	551
3.2 <KDBQ44BA60A> Panel Spacer.....	553
3.3 <BDBHQ44C60> Sealing Member.....	555
3.4 <KDDQ44XA60> Fresh Air Intake Kit.....	557
4. Outdoor Unit	559
4.1 <KPW063B4> Air Direction Adjustment Grille	559
4.2 <KPW082A41> Air Direction Adjustment Grille	561
4.3 <KKG063A42> Back Protection Wire Net	563
4.4 <KKG082A41> Back Protection Wire Net	564
4.5 <BKP082A41> Drain Plug	566
4.6 <KEH063A4E> Drain Pan Heater.....	568
4.7 <KEH082A41> Drain Pan Heater	578
4.8 <KPS063A41> Snow Hood (Side).....	582

4.9 <KPS063A44> Snow Hood (Rear) 584
4.10 <KPS063A47> Snow Hood (Discharge)..... 586

1. Options List

1.1 Indoor Unit

Wall Mounted and Floor Standing

Option Name		CTXS/FTXS	FTXR	FVXS
Wired remote controller ★1		BRC944B2	BRC944B2	-
Wired remote controller cord (shielded wire)	Length 9.8 ft (3 m)	BRCW901A03	BRCW901A03	-
	Length 26.3 ft (8 m)	BRCW901A08	BRCW901A08	-
Wireless LAN connection adaptor		AZAI6WSCDKB	AZAI6WSCDKB	AZAI6WSCDKB
Wiring adaptor for timer clock / remote controller ★2 (normal open pulse contact / normal open contact)		KRP413BB1S	KRP413BB1S	KRP413BB1S
Central remote controller ★3		DCS302C71	DCS302C71	DCS302C71
Unified ON/OFF controller ★3		DCS301C71	DCS301C71	DCS301C71
Schedule timer controller ★3		DST301BA61	DST301BA61	DST301BA61
Interface adaptor for DIII-NET (residential air conditioner)		KRP928BB2S	KRP928BB2S	KRP928BB2S
Titanium apatite deodorizing filter (without frame)	KAF952A42 (07/09/12) ★4	KAF970A46	KAF970A46	KAF968B42
	KAF970A46 (15/18/24) ★4			
Remote controller loss prevention with chain		KKF910A4	KKF910A4	KKF910A4

★1 A wired remote controller cord BRCW901A03 or BRCW901A08 is necessary.

★2 Timer clock and other devices; obtained locally.

★3 An interface adaptor (KRP928BB2S) is also required for each indoor unit.

★4 Standard accessory

Duct Concealed and Ceiling Cassette

	Option Name	CDMQ/FDMQ	FFQ
Required Option	Wired remote controller ★1	BRC1E73	BRC1E73
	Wireless remote controller	BRC082A43	-
		-	BRC082A41W (for BYFQ60B3W1) ★2
		-	BRC082A42W (for BYFQ60C2W1W) ★2
		-	BRC082A42S (for BYFQ60C2W1S) ★2
		-	BYFQ60B3W1
	Decoration panel	-	BYFQ60C2W1W
		-	BYFQ60C2W1S
		-	BYFQ60C2W1S
Option	Wireless LAN connection adaptor	AZAI6WSCDKA	AZAI6WSCDKA
	Central remote controller	DCS302C71	DCS302C71
	Unified ON/OFF controller	DCS301C71	DCS301C71
	Schedule timer controller	DST301BA61	DST301BA61
	Remote sensor	KRCS01-4B	KRCS01-4B
	Wiring adaptor	KRP1C74 ★3	KRP1C75 ★4
	Wiring adaptor for electrical appendices	-	KRP4A74
	Installation box for adaptor PCB	KRP4A98	KRP1BA101
	Sensor kit	-	BRYQ60A2W (for BYFQ60C2W1W)
		-	BRYQ60A2S (for BYFQ60C2W1W)
	Panel spacer	-	KDBQ44BA60A (for BYFQ60B3W1)
	Sealing member of air discharge outlet	-	BDBHQ44C60
	Fresh air intake kit (direct installation type)	-	KDDQ44XA60
	Longlife filter	-	KAFQ441BA60
	Remote controller loss prevention with chain	KKF910A4	-

★1 Wiring for wired remote controller should be obtained locally.

★2 Sensing function and individual flap control function are not available.

★3 Installation box for adaptor PCB (KRP4A98) is necessary.

★4 Installation box for adaptor PCB (KRP1BA101) is necessary.

1.2 Outdoor Unit

Option Name	Standard		Cold Climate			
	2/3/4MXS	5MXS	2/3MXL	4MXL	2/3MXLH	4MXLH
Air direction adjustment grille	KPW063B4	KPW082A41	KPW063B4	KPW082A41	KPW063B4	KPW082A41
Back protection wire net	KKG063A42	KKG082A41	KKG063A42	KKG082A41	KKG063A42	KKG082A41
Drain plug ★	KKP937A4	BKP082A41	KKP937A4	BKP082A41	KKP937A4	BKP082A41
Drain pan heater	FTDBHML	-	FTDBHML	-	-	-
	KEH063A4E	KEH082A41	KEH063A4E	KEH082A41	-	-
	KEH063A4EA	KEH082A41A	KEH063A4EA	KEH082A41A	-	-
Snow hood (intake side plate)	-	-	KPS063A41	-	KPS063A41	-
Snow hood (intake rear plate)	-	-	KPS063A44	-	KPS063A44	-
Snow hood (outlet)	-	-	KPS063A47	-	KPS063A47	-

★ Standard accessory

2. Control Devices

2.1 <BRC944B2> Wired Remote Controller (Installation)

⚠ CAUTION

1. No switch box or staple is supplied. Prepare them locally.
2. No remote controller cord is supplied. Prepare the optional remote controller cord 4 wire.
3. Be sure to turn off the power to any apparatus connected prior to mounting.
4. Prior to mounting equipment, touch something metallic such as a doorknob to remove static electricity from your body. Never touch the remote controller board or the adapter board.
5. Keep the wiring away from any other power source lines to avoid electric noise (external noise).
6. Select a flat surface, wherever possible, to mount the remote controller. To prevent deformation of the cases, do not overtighten the mounting screws.

1. Securing the remote controller lower case

Insert a bladed screwdriver into the concave (凹) in the remote controller lower case to remove the upper case assembly (two locations).

The remote controller board is located on the upper case. Take care not to scratch the board with the screwdriver.

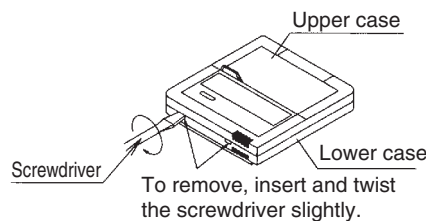

(1) Exposed mounting

Secure the remote controller lower case with the two supplied wood screws.



(2) Embedded mounting

Secure the remote controller lower case with the two supplied machine screws.

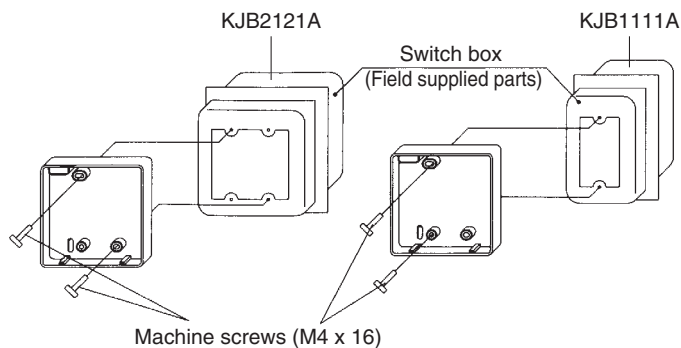

For the field supplied switch box,
use optional accessories
KJB1111A or KJB2121A.

2. Securing the remote control adapter

Remove the upper case of the remote control adapter and secure the lower case assembly.

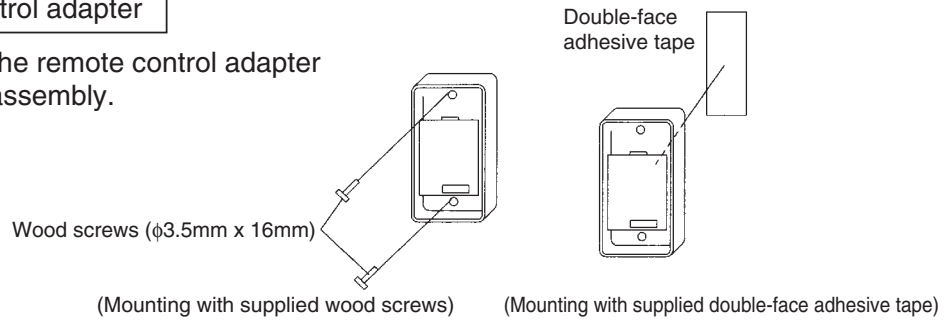

3. Wiring

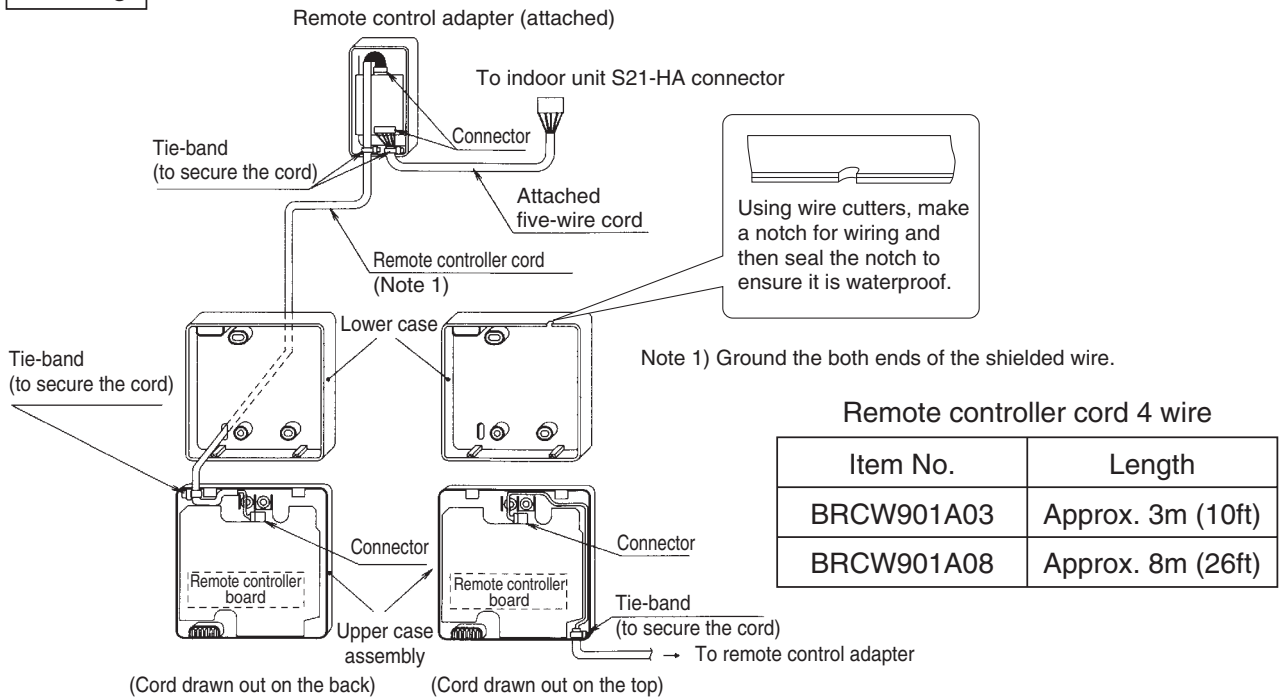

4. Placing the upper case assembly of the remote controller and the upper case of the remote controller adapter back into their original positions

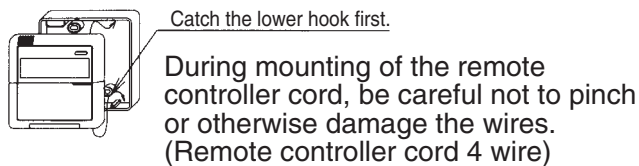

5. Temperature indication change

To change from Celsius temperature indication to Fahrenheit one

Press and hold down  at the same time for 5 seconds while the Celsius temperature is indicated.

← See Operation Manual

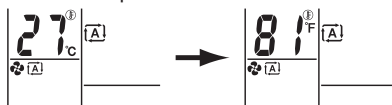

2.2 <BRC944B2> Wired Remote Controller (Operation)

Controller Commands and their Corresponding Functions

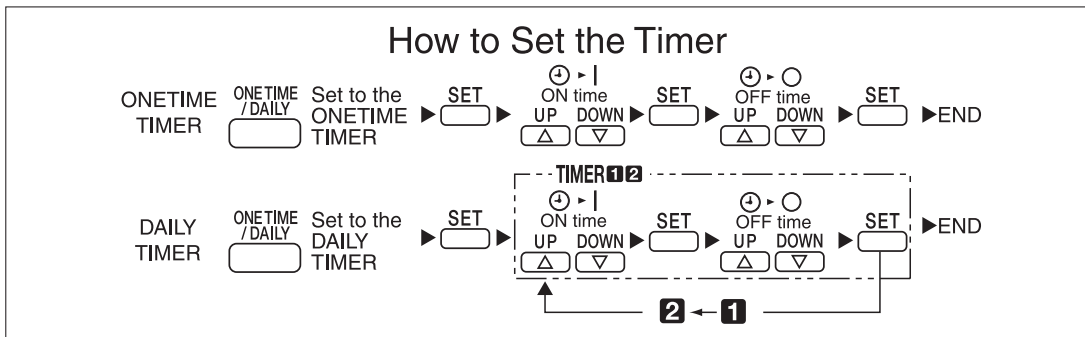
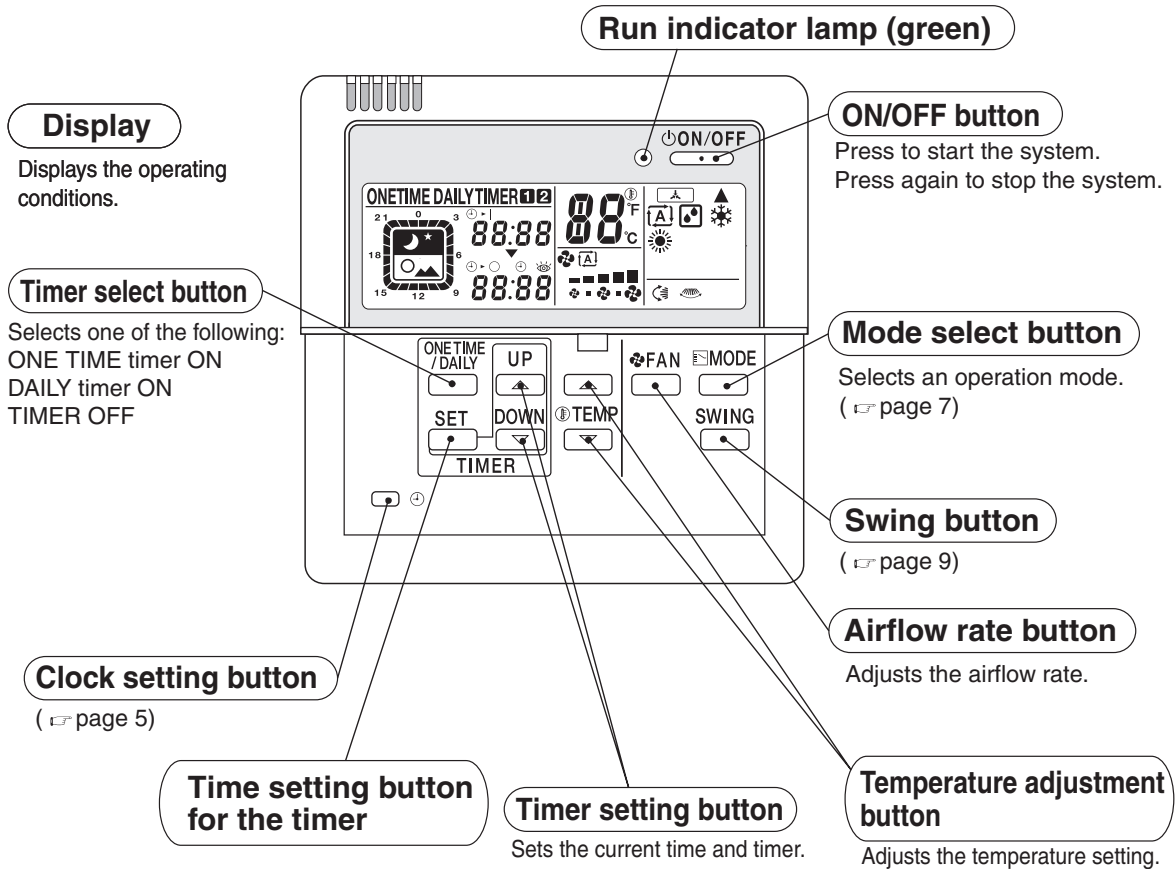

CAUTION

- This remote controller cannot be used together with a standard wireless remote controller. Otherwise, what appears on this remote controller's display may fail to correspond to actual operating conditions.

Preparation before Operation

■ Checking the power

If nothing appears on the remote controller's display, turn on the circuit breaker.

■ Setting the current time

1 Press .



The current time starts blinking.
0:00 lights up.



2 Press and set the current time.

- Hold the button down to rapidly advance the time.

3 Press .

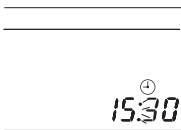

: blinks.
(This completes the current time setting)

- The clock's accuracy is ±30 seconds per month.

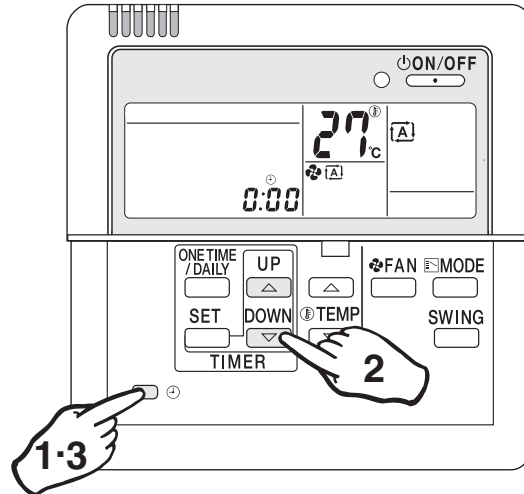

Notes

To use the unit efficiently

- Avoid overcooling or overheating. Moderate room temperature setting contributes to power saving.

Recommended temperature setting

For cooling 26~28°C (79°F~82°F)

For heating 20~22°C (68°F~72°F)
- Hang a blind or a curtain on the window. This will enhance the cooling/heating effect by intercepting direct sunlight and drafts.
- A clogged air filter reduces the cooling/heating effect and wastes energy. Clean the air filter monthly (every two weeks as required) or so.

Please take note of the following points

- Electric power is consumed even when the air conditioner is not in operation.
- When the unit is not used for a long period of time such as during off-season, turn off the breaker.

Operating conditions

- If the operation is continued under any conditions other than the following, the safety device may work to stop the operation. Also, dew may form on the indoor unit and drip from it. (Cooling/DRY)

Cooling	Outdoor temp.	-10 to 46°C (14°F to 115°F)
	Room temp.	18 to 32°C (64°F to 90°F)
	Indoor humidity	Less than 80%
DRY	Outdoor temp.	-10 to 46°C (14°F to 115°F)
	Room temp.	18 to 32°C (64°F to 90°F)
	Indoor humidity	Less than 80%
Heating	Outdoor temp.	-15 to 20°C (5°F to 68°F)
	Room temp.	Less than 27°C

- Operation limit differ according to the model.

Preparation before Operation

■ Setting Temperature Indication change

Temperature indication can be changed between Celsius and Fahrenheit before use.

To change from Celsius temperature indication to Fahrenheit one

- 1 Press and hold down  at the same time for 5 seconds while the Celsius temperature is indicated.

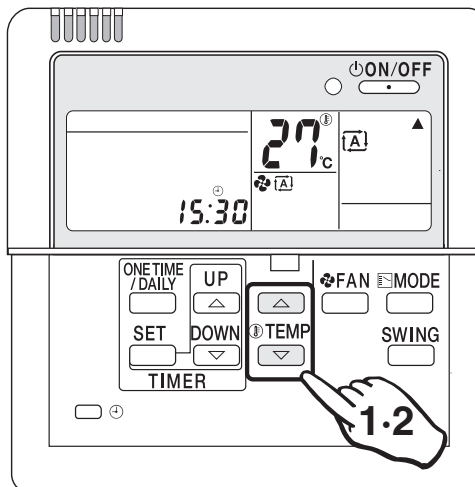

To change from Fahrenheit temperature indication to Celsius one

- 2 Press and hold down  at the same time for 5 seconds while the Fahrenheit temperature is indicated.



Notes

■ Temperature indication change between Celsius and Fahrenheit on the remote controller

- Change the temperature indication in the modes other than the DRY mode.
In the DRY mode, temperature indication setting cannot be changed because the temperature is not indicated.
- When the Fahrenheit temperature indication is changed to Celsius one, the temperature value (0.5°C) will be rounded up. Thus, the preset temperature may be changed.

Example:

A preset temperature of 65°F (equivalent to 18.5°C) will be changed to 19°C (66°F) by changing the temperature indication. In this case, if you change the Celsius temperature indication again to the Fahrenheit one, the preset temperature is shown not as 65°F but as 66°F (equivalent to 19°C). If the preset temperature is 66°F (equivalent to 19°C) and is changed to the Celsius temperature indication, the indication becomes 19°C (66°F). In this case, no change by the temperature indication change is observed.

- When the temperature indication change is set, the preset temperature is transmitted to the indoor unit so that the reception sound will be heard from the indoor unit.

Automatic·DRY·Cooling·Heating Operation

Select your desired operation mode.

Once preset, the system can get restarted in the same operation mode.

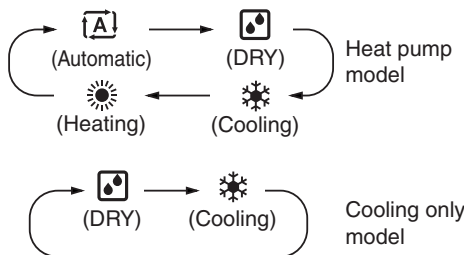
- 1** Press  to select your desired operation mode.
- Each time the button is pressed, the mode changes as follows.
- 
- The system does not have the FAN mode.

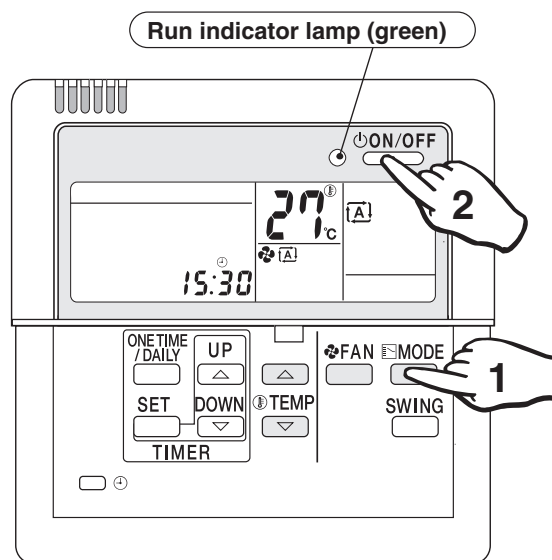

- 2** Press  .
The run indicator lamp lights up.

■ To stop the operation:

- Press  again.
The run indicator lamp goes out.

Automatic operation

- In Automatic, the temperature setting and operation mode (DRY, Cooling or Heating) are automatically selected according to the room temperature and outdoor temperature at the time of starting operation.

DRY operation







- In this mode, humidity is removed from the air.

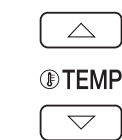

Note

- While running in the DRY mode, you may feel cool or warm air from the air outlet. In this case, readjust the airflow direction with the vertical airflow direction louvers. (except Duct Connected type)

■ To adjust the temperature and airflow rate:

Operation mode Setting to be adjusted	Automatic	Cooling	Heating	DRY
 (Temperature)	Temperature is adjustable. Recommended temperature Cooling : 26°C-28°C (79°F~82°F) Heating : 20°C-22°C (68°F~72°F)			Temperature cannot be adjusted.
 (Airflow rate)	Five levels of airflow rate setting from "  " to "  " plus "  " are available. 			Airflow rate cannot be adjusted.

- When the unit runs in the cooling or heating mode at a low airflow rate, the cooling or heating effect may be insufficient.

■ To adjust the airflow direction:

( page 9)

Heating operation

- Since the heating operation is performed by taking the heat from outdoor into the room, the heating capacity decreases as the outdoor temperature lowers. If the room is not heated sufficiently, it is recommended to use other heating appliance at the same time.
- Since the air conditioner heats the whole room by circulating hot air, it takes some time to heat the entire room completely.
- If the outdoor unit gets frosted during heating operation, the heating capacity is decreased. In this case, the unit starts defrosting operation.
- No hot air comes out of the indoor unit during defrosting operation.

Adjusting Airflow Direction

Adjust the airflow direction for maximum comfort.

To adjust the Airflow Direction

- 1 Press  during operation.
 - Each time the button is pressed, the airflow direction louvers change their movement.

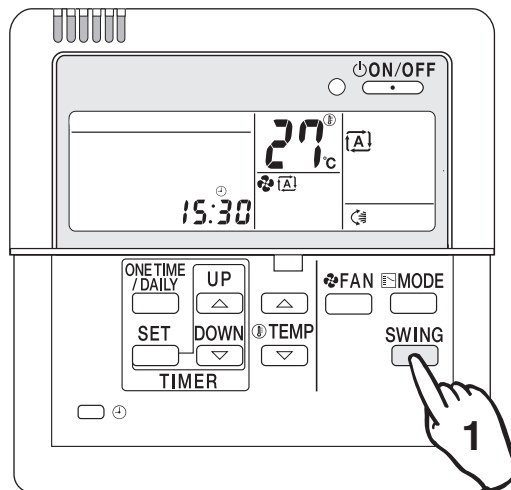

■ Wall Mounted Types (without horizontal swing function)

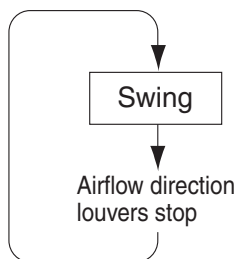

The horizontal airflow direction louvers move up and down.

The louvers stop just when the button is pressed.

Adjustment of horizontal airflow direction

- The automatic moving range of the horizontal airflow direction louvers varies depending on the operation mode.



Notes

- In fixing the horizontal airflow direction, keep the horizontal airflow direction louvers tilted downward in the heating mode, and keep them nearly horizontal level in the cooling or DRY mode. This will enhance the cooling and heating effect.
- On the air conditioners with vertical and horizontal swing function, be sure to adjust the airflow directions using the remote controller. Do not forcibly adjust louvers by hand or a malfunction may occur.

■ Wall Mounted Type (with horizontal swing function)

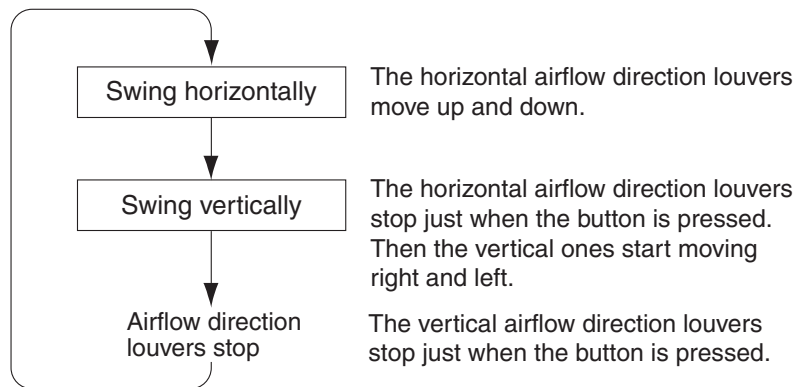

- The vertical and horizontal louvers cannot move at the same time.

■ Duct Connected Type (without swing function)

This function cannot be used.



Note

- The operating procedure and remote controller display are different depending on the indoor unit being connected. Read **How to Adjust the Airflow Direction** in the air conditioner's Operation Manual.

Timer Operation

The Timer Operation feature automatically turns off operation when you go to sleep and turns it back on when you wake up.

Use the DAILY Timer mode on weekdays, and the ONE TIME timer mode on weekends.

■ To select the ONE TIME timer mode:

1 Press  to select the ONE TIME timer mode.

- Each time the button is pressed, the modes change as follows.

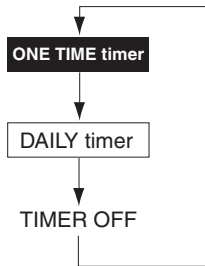

The timer lamp lights up.

■ To cancel the timer settings:

1 Press  to clear the timer settings.

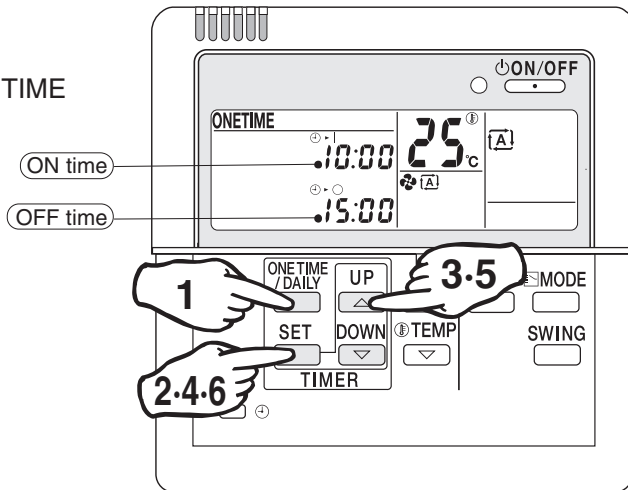
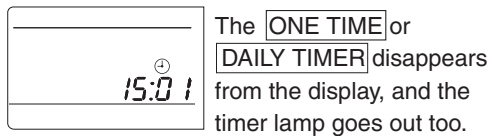

(Timer settings displayed)



Notes

- Even when the timer has been off, its programmed settings are still in memory.
- If the system has the timer control ON but you start and stop it manually using the ON/OFF button before the designated ON time, the system will restart again at the programmed ON time.

Precautions in setting the timer

- Before starting the timer operation, make sure the current time is correct. If not, set the clock correctly. (☞ page 5)
- In making time settings, --:-- is displayed to make it easy to disable the timer too.
- If one minute has passed before making any timer setting, the previous timer settings are reintroduced and the timer is on standby. In this case, use the  (time setting) button and make your desired timer settings.

Timer operation

- When the ON timer is programmed, the system starts one hour (maximum) earlier so that the temperature set by the remote controller is reached just in time.
- When the ONE TIME timer is programmed, the current time is no longer displayed.

■ ONE TIME timer

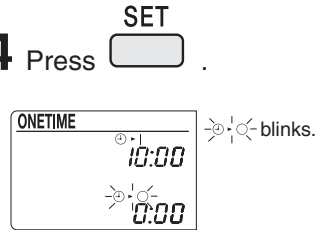
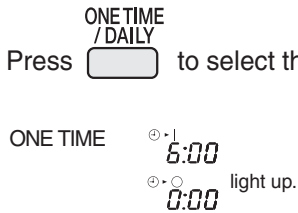

Once the timer has been activated and then deactivated, it is in the OFF mode. The ON or OFF timers can be programmed.

1 Press  to select the ONE TIME timer. **4** Press .



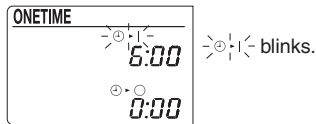

2 Press .

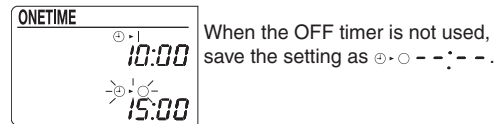

5 Press   to make the OFF timer setting.



3 Press   to make the ON timer setting.

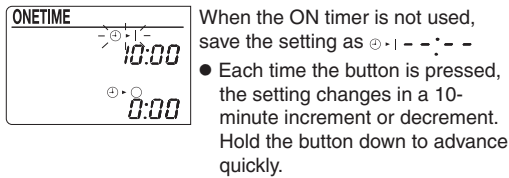

6 Press  .
(The ONE TIME timer is now programmed.)

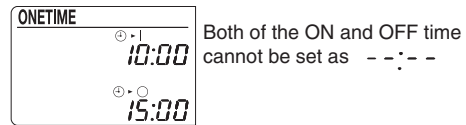

Example of display with the ONE TIME timer programmed

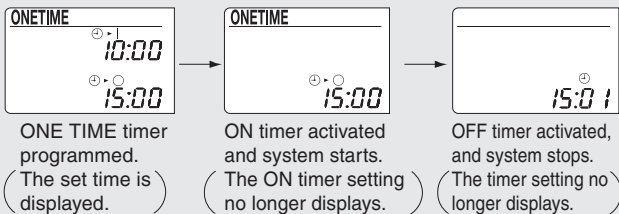

Notes

- In the following cases, reset the clock (the time setting is kept in the memory).
 - The circuit breaker has been activated.
 - The power fails.

Timer Operation

■ To select the DAILY timer mode:

1 Press  to select the DAILY timer mode.

- Each time the button is pressed, the modes change as follows.

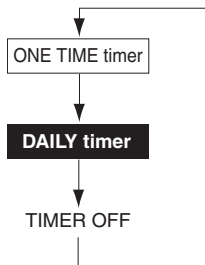

The timer lamp lights up.

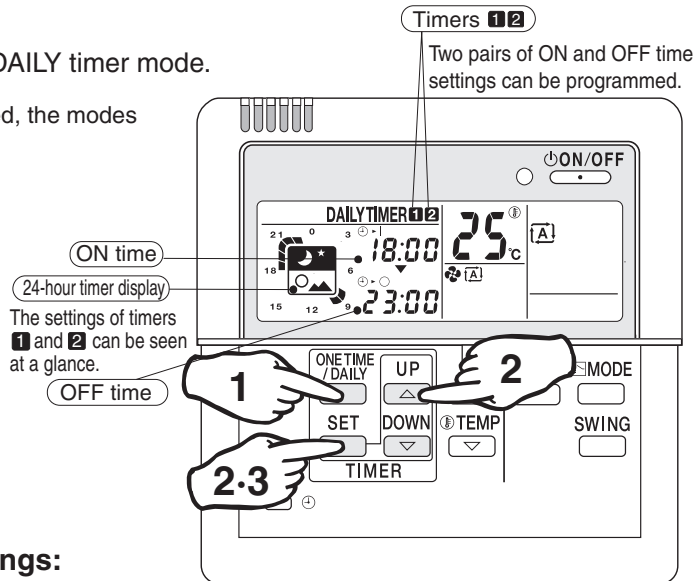

(Timer settings displayed)

■ To cancel the timer settings:

1 Press  to clear the timer settings.

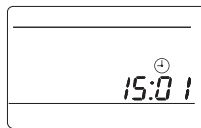

The **ONE TIME** or **DAILY TIMER**, and the timer lamp are no longer displayed.

Example of display with DAILY timer programmed

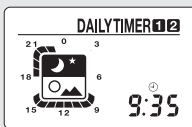

Timers **1** and **2** programmed.

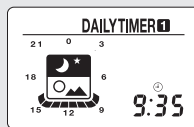

Timer **1** alone programmed.





Note







- The system starts and stops repeatedly until the DAILY timer is set off. Before you leave home for a long time, set the DAILY timer off.

■ DAILY timer

After programming, the system starts and stops each day at the preset times. Two pairs of time settings can be programmed.

(Example: 8:00 ~ 10:00, and 18:00 ~ 23:00)

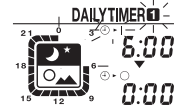
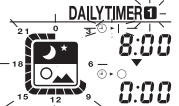
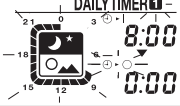
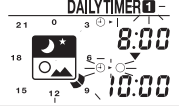
- 1 Press  to select the DAILY timer.  lights up. DAILY timer indication appears.
- 2 Make the ON and OFF time settings. ● Take the steps from ① to ⑧.
Program example: 8:00 ~ 10:00, and 18:00 ~ 23:00

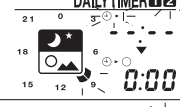
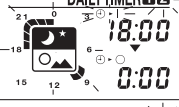
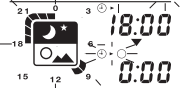
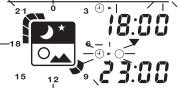
Settings		Procedure	
		Press 	Press  to make the timer setting. 
 1	ON time setting ● When the timer 1 is not used, save the setting as ①-1-:-:-	① 	② 
	OFF time setting	③ 	④ 
 2	ON time setting ● When the timer 2 is not used, save the setting as ⑤-1-:-:-	⑤ 	⑥ 
	OFF time setting	⑦ 	⑧ 

- 3 Press  . The DAILY timer is now programmed.



Note

- If the following appears on the display, the timer must be reprogrammed.

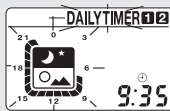

The 24-hour timer display is blinking.

This means that Timers 1 and 2 are programmed for the same time settings. New time settings must be made.



The 24-hour timer display is blinking.

This means that the timer has not been programmed yet.

Cleaning

Cleaning the remote controller

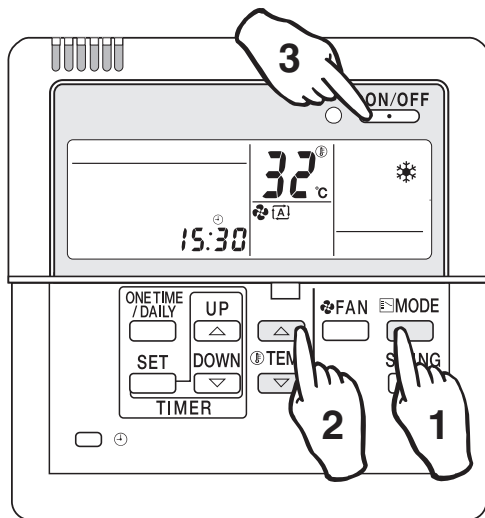

- Wipe it clean with soft, dry cloth.
Do not use any water hotter than 40°C (104°F), or volatile liquids such as benzene, gasoline and thinner, polishing powder, or anything hard such as a scrub brush.

When the unit is not used for a long time



- On a sunny day, keep the system running for half a day in the FAN mode to dry it up inside.

FAN mode

- Press  to select the cooling mode.
 - Press  to adjust the set temperature to 32°C (90°F).
 - Press  .
 - The airflow rate remains the same, and is not adjustable.
 - Run the system when the room temperature is below 28°C (82°F).
- Finally turn off the circuit breaker dedicated for the room air conditioner.
 - Clean the air filter and place it back into position.

2.3 <BRCW901A03/08> Wired Remote Controller Cord

Safety Precautions

- Turn OFF the controlled equipment when connecting the equipment.
- Hold the plug of the connector when connecting or disconnecting the connector.

Precautions for Use

- This remote controller cable is of thin-profile BRC944-series remote controller units.
- Be sure to ground both ends of the shield wire.
- Install the controlled equipment after reading through the installation manual of the equipment.

Complete Parts

• Remote Controller Cable

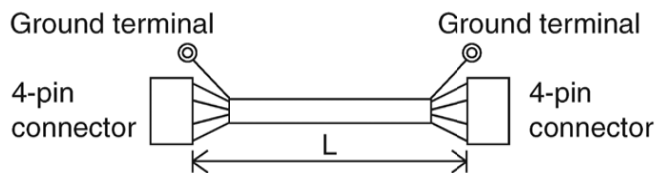

Parts number	L
BRCW901A03	Approx. 3m
BRCW901A08	Approx. 8m

• Installation Manual



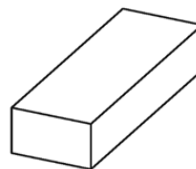

• Packing Case



2.4 <KRP413BB1S> Wiring Adaptor

Safety Precautions

- Read these safety precautions carefully before installing the unit, and be sure to install the unit properly.
- This manual classifies precautions to the user into the following two categories. These warnings and cautions are for your safety. Follow them.

 WARNING	Faulty installation can result in death or serious injury.
 CAUTION	Faulty installation can result in serious injury, damage to property, or other serious consequences.

- After installation is complete, test the unit to confirm that it is working properly, and instruct the owner its proper use.

WARNING

- Installation should be left to the dealer from whom you purchased the unit, or another qualified professionals.
- Install the unit securely according to the installation manual. Faulty installation may lead to electric shock or fire.
- Be sure to use the supplied or specified parts. Using other parts may lead to electric shock or fire.
- Install the unit securely in a location that will support its weight. If installed in a poor location or improperly installed, the unit may not work as intended.
- For electrical work, follow local electric standards and the installation manual. Faulty installation may lead to fire or electric shock.
- Do not bundle the power cord, or attempt to extend it by splicing it with another cord or by using an extension cord. Do not place any other load on the power circuit used for the unit. Improper wiring may lead to electric shock, heat generation or fire.
- Use dedicated wiring for all electrical connections, and be sure to arrange the wiring so that force applied to the wiring will not damage the terminals. Poor wiring or installation may cause electric shock, heat generation or fire.

CAUTION

- Before installation, unplug the air conditioner to ensure safety. Failure to do so may cause electric shock.
- Static electricity may damage electric components. Before connecting cables and communication lines, and operating the switches, be sure to discharge any electrical charge from your body (by, for example, touching the earth line)
- Do not install the unit in a location where it may be exposed to flammable gases. If gas leaks and build up around the unit, it may catch fire.
- Do not place the wiring close to the power cord, inter-unit cable, or pipes which generate noise. Treat the wiring with care.

1. Functions and Features

- On/Off setting
- Switching between Instantaneous Contact/Normal Contact
- Connection with fan coil remote controller
- Automatic reset after power failure
- Output of normal operation signals/malfunction signals

2. Field Wiring

For interconnecting wiring, use Daikin KDC100A12 cable (not supplied) or other similar cable. Use a vinyl-covered wire or cable with four conductors each with a thickness of 0.2 to 1.25 mm².

■ Optional cable KDC100A12 (without connectors)

Specifications: 0.2 mm² × 4 core (sheathed)
 Outer diameter: φ5.3
 Length: 100 m
 Colour: Grey

Note : Keep any wiring for the control unit away from the power cord to prevent electrical noise.

Installation ①

1 Installation diagram

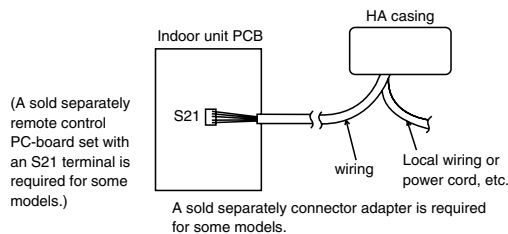

2 Components

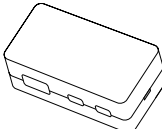
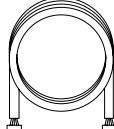
① HA casing ASSY (Remote Control PCB is attached in the HA casing.) 	② Wiring (approx. 0.8 m) (Cannot be made longer.) 
③ Accessories Binding band (6 pcs.) • Screws for attaching to the wall (3 pcs.)	
④ Installation manual	

Installation ②

Attaching HA Case ASSY

- Use the 3 supplied screws to attach the HA casing ASSY.

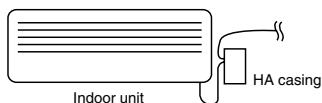

Install the HA casing ASSY as close to the indoor unit as possible.

① Removal of upper HA casing

- (1) Insert a flat-blade screwdriver into the groove between the upper and lower HA casings.

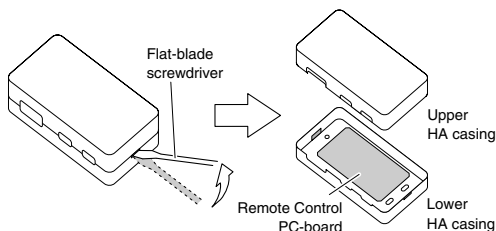

- (2) Lift the handle of the screwdriver upward.

- ② Mount and secure the lower HA casing directly on the wall with the provided screws inserted into the screw holes (a round hole and two ellipse holes) of the casing.

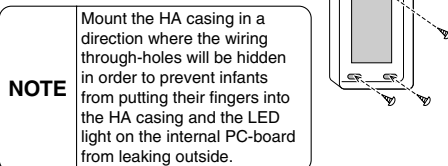

NOTE

Mount the HA casing in a direction where the wiring through-holes will be hidden in order to prevent infants from putting their fingers into the HA casing and the LED light on the internal PC-board from leaking outside.

- ③ After connecting the cables (refer to the following sections), replace the case front. Be careful not to damage the wiring in the case.

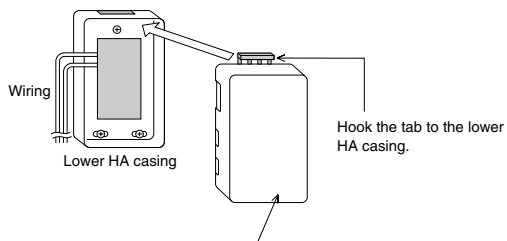

Press the lower part of the upper HA casing and press fit it onto the lower HA casing.
Press the upper HA casing precisely until a clicking sound is heard.

Wiring ①

1. Wiring

- ① Connect one end of the wiring to connector S21 of the PCB in the indoor unit.
- ② Connect the other end of the wiring to connector S6 of the Remote Control PCB.
- ③ Connect field wiring according to the functions assigned to each connection terminal of the Remote Control PCB.
- ④ Secure all wires.

1 Securing wires in the HA casing ASSY

① Connection of wiring

Connect the wiring to the connector terminals.

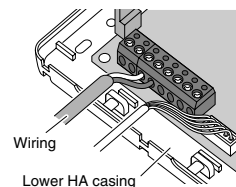

② Fixation of wiring

- (1) Insert the provided binding band under the pillar of the HA casing and secure the covers of the wiring with the binding band.

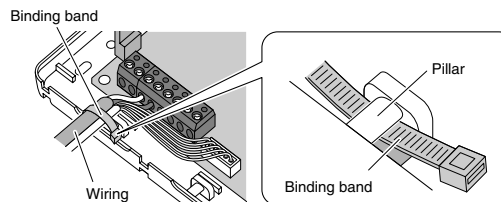

- (2) Insert the second binding band into the groove on the side of the HA casing and fix the wiring securely so that the wiring will not be disconnected.

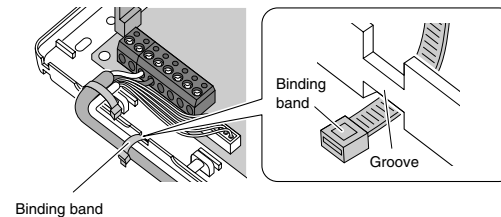

A large number of wires

Make a slit with an appropriate tool, such as a cutter knife, on the thin part of the upper HA casing along the frame. Then cut the part with an appropriate tool, such as a pair of nippers.

(NOTE) Cut off only the thin part required for wiring.

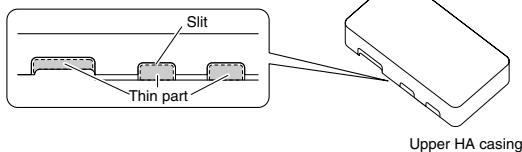

2 Securing wires in the indoor unit

- The method for securing wire varies depending on the model of the air conditioner. See your air conditioner installation manual for details.

Wiring ②

2. Automatic Reset After Power Failure

- This PCB stores the following data in the event of a power failure (the storage period is limitless).
 - ① On/Off (see Note 1)
 - ② Operation modes (see Note 2)
 - ③ Temperature setting
 - ④ Air flow rate
 - ⑤ On/Off status of remote controller
- (Note 1 When SW1-2 is in Off mode, the unit will not be activated.)
 (Note 2 The following settings apply to the models below.)

Mode before the power outage	COOLING	HEATING
Room air conditioner		
Models with Humid heating and Reheating dehumidifying functions.	DRY COOLING	HUMID HEATING
Models with Reheating dehumidifying function.		HEATING

(Note 3 Not all settings will be saved (e.g., humidity or swing settings will not be saved).)

3. Monitor Signal Output (normal operation and malfunction)

- Maximum length of the wiring is 100 m. No external power supply is required.

1 Monitor signal output for LED

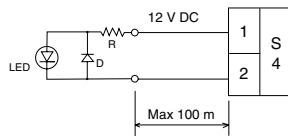

■ Locally procured parts

Item	Manufacturer	Type
LED	Rohm	SLR-342
D	Rohm	1SS133
R		510 ohm 1/4W

2 Monitor signal output (normal operation and malfunction) using external relay contacts

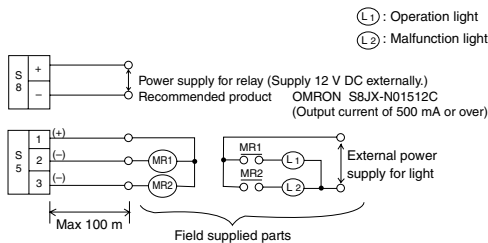

■ Field procured parts (Recommended external relay contacts)

Manufacturer	Type	Coil rated voltage	Coil resistance
Omron	MY relay	12 V DC	160 ohm ± 10%

4. Connection with Remote Controller

Example connections with three kinds of remote controllers are shown below.
 Note: These connections cannot be used in combination.

1 Remote control with switch (field supply)

- Set SW1-1 to Off and select Operation Mode 1.



<Instantaneous Contact>

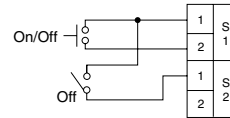

- The remote controller most recently used (local or air conditioner) takes precedence.
- Use a remote controller with a pulse width of 100 msec or more.

<Normal Contact>

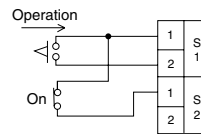

- Power On/Off cannot be controlled from the unit's remote controller. (Three beeps for signal reception will be heard continuously when the wireless remote controller is operated.)
- When power is restored after a power failure in this mode, On or Off is determined according to the current settings of the remote controller.

2 Fan coil remote controller

- Set SW1-1 to On and select Operation Mode 2.
- Most settings (power On/Off, air flow rate, mode change) cannot be made using the air conditioner's remote controller.
- When power is restored after a power failure in this mode, On or Off is determined according to the current settings of the remote controller.
- When the Cooling/Heating mode is changed, use the air conditioner's remote controller to adjust the temperature.

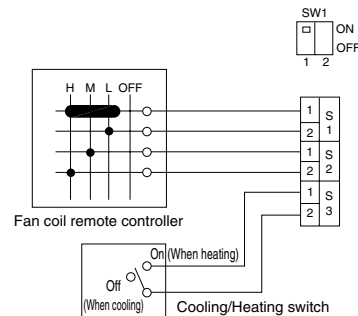

Test Operation and Confirmation

1. When the System is Not Working

- Is the air conditioner working properly?
- Are the connectors of the wiring properly connected?
- Are the remote controller and field wiring properly connected?
- Are all switch settings correct?
- If there is nothing apparently wrong, conduct a diagnostic check using the following procedure.

■ Diagnostic check

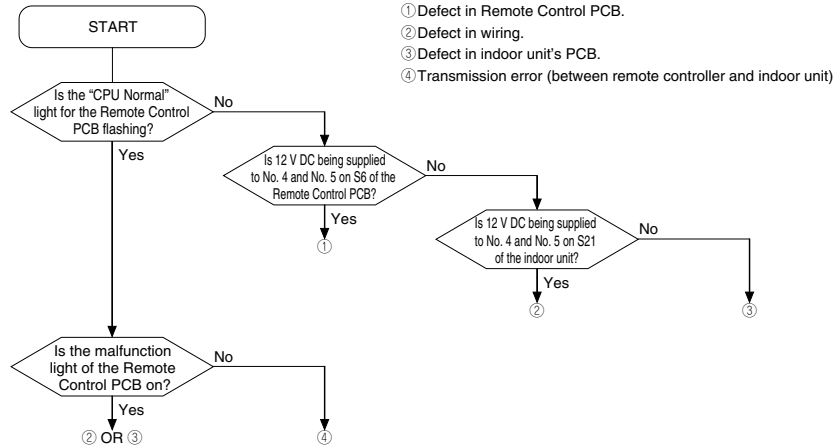

2. Switch Settings and Connection Terminals

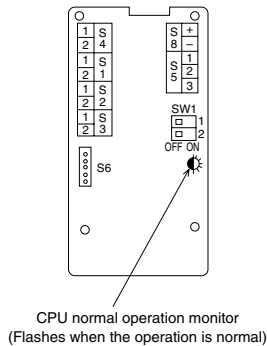

SW1-1	Selecting the operation mode	OFF	Operation mode 1 (Used with the exception of fan coil remote controller settings)		
		ON	Operation mode 2 (Used with fan coil remote controller settings)		
SW1-2	Selecting On/Off when power is restored after a power failure	OFF	Always Off		
		ON	Off if operation was in Off mode before power failure; On if operation was in On mode before power failure		
S1 S2 S3	SW1-1: OFF (Operation mode 1)			Instantaneous contact	Normal contact
		S1 (1) - S2 (1)		OPEN	CLOSE
		S1 (1) - S1 (2)		Pulse input On/Off switching	OPEN, Not activated CLOSE, Activated
		S2 (2), S3		Not used	
		S1, S2 OPEN		Not activated	
	SW1-1: ON (Operation mode 2)		S1 (1) - S1 (2) CLOSE		On, airflow: L tap
			S1 (1) - S2 (1) CLOSE		On, airflow: M tap
			S1 (1) - S2 (2) CLOSE		On, airflow: H tap
			S3 (With the remote controller only)		OPEN Cooling CLOSE Heating
	S4	(1) - (2)	Voltage on (12 V DC), normal operation light output		
S5	(1) - (2)	Normal operation light output (power for light required)			
	(1) - (3)	Malfunction light output (power for light required)			
S6 connector		Connect with connector S21 on the PCB of the indoor unit			
S8	(+)-(-)	Relay 12 V DC power supply terminal (Field supplied parts)			

2.5 <DCS302C71> Central Remote Controller (Installation)

Please read these "SAFETY CONSIDERATIONS" carefully before installing air conditioning equipment and be sure to install it correctly. After completing the installation, make sure that the unit operates properly during the start-up operation. Please instruct the customer on how to operate the unit and keep it maintained. Also, inform customers that they should store this installation manual along with the operation manual for future reference. This air conditioner comes under the term "appliances not accessible to the general public".

Meaning of warning, caution and note symbols.

- ⚠ WARNING** Indication a potentially hazardous situation which, if not avoided, could result in death or serious injury.
⚠ CAUTION Indication a potentially hazardous situation which, if not avoided, may result in minor or moderate injury. It may also be used to alert against unsafe practices.
⚠ NOTE Indication situation that may result in equipment or property-damage-only accidents.

⚠ WARNING

Ask your dealer or qualified personnel to carry out installation work. Do not try to install the machine by yourself.
 Improper installation may result in water leakage, electric shocks or fire.

Perform installation work in accordance with this installation manual.
 Improper installation may result in water leakage, electric shocks or fire.

Be sure to use only the specified accessories and parts for installation work.
 Failure to use the specified parts may result in water leakage, electric shocks, fire or the unit falling.

Carry out the specified installation work after taking into account strong winds, typhoons or earthquakes.
 Improper installation work may result in the equipment falling and causing accidents.

Make sure that a separate power supply circuit is provided for this unit and that all electrical work is carried out by qualified personnel according to local laws and regulations and this installation manual.
 An insufficient power supply capacity or improper electrical construction may lead to electric shocks or fire.

Make sure that all wiring is secured, the specified wires and used, and no external forces act on the terminal connections or wires.
 Improper connections or installation may result in fire.

When wiring the power supply and connecting the remote controller wiring and transmission wiring, position the wires so that the electric parts box lid can be securely fastened.
 Improper positioning of the electric parts box lid may result in electric shocks, fire or the terminals overheating.

Before touching electrical parts, turn off the unit.

Ground the air conditioner. Do not connect the ground wire to gas or water pipes, lightning rod or a telephone ground wire.
 Incomplete grounding may result in electric shocks.

When installing or relocating the system, be sure to keep the refrigerant circuit free from substances other than the specified refrigerant (R410A), such as air.

Do not reconstruct or change the settings of the protection devices.
 If the pressure switch, thermal switch, or other protection device is shorted and operated forcibly, or parts other than those specified by Daikin are used, fire or explosion may result.

Do not touch the switch with wet fingers.
 Touching a switch with wet fingers can cause electric shock.

Install an leak circuit breaker, as required.
 If a leak circuit breaker is not installed, electric shock may result.

Do not install the air conditioner or the remote controller in the following locations:

- (a) where a mineral oil mist or an oil spray or vapor is produced, for example in a kitchen
 Plastic parts may deteriorate and fall off or result in water leakage.
- (b) where corrosive gas, such as sulfurous acid gas, is produced
 Corroding copper pipes or soldered parts may result in refrigerant leakage.
- (c) near machinery emitting electromagnetic waves
 Electromagnetic waves may disturb the operation of the control system and result in a malfunction of the equipment.
- (d) where flammable gases may leak, where there are carbon fiber or ignitable dust suspensions in the air, or where volatile flammables such as thinner or gasoline are handled.
 Operating the unit in such conditions may result in fire.

⚠ CAUTION

Be very careful about product transportation.

Safely dispose of the packing materials.
 Packing materials, such as nails and other metal or wooden parts, may cause stabs or other injuries. Tear apart and throw away plastic packaging bags so that children will not play with them. If children play with a plastic bag which was not torn apart, they face the risk of suffocation.

Do not turn off the power immediately after stopping operation.
 Always wait at least five minutes before turning off the power. Otherwise, water leakage and trouble may occur.

⚠ NOTE

Install the indoor and outdoor units, power supply wiring and connecting wires at least 3.5ft. away from televisions or radios in order to prevent image interference or noise.
 (Depending on the radio waves, a distance of 3.5ft. may not be sufficient enough to eliminate the noise.)

Remote controller (wireless kit) transmitting distance can result shorter than expected in rooms with electronic fluorescent lamps.(inverter or rapid start types)
 Install the indoor unit as far away from fluorescent lamps as possible.

This unit is a class A product.
 In a domestic environment this product may cause radio interference in which case the user may be required to take adequate measures.

Dismantling of the unit, treatment of the refrigerant, oil and eventual other parts, should be done in accordance with the relevant local and national regulations.

1 COMPONENTS

Check the following components are included in this optional accessory before installation.

Installation screw (M4 x 16)	4
Operation manual	1
Installation manual	1
Installation table	1

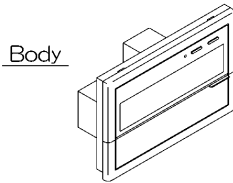

When using this optional accessory an electric parts box of KJB311A is required. For installation, a steel electric parts box to be embedded is mandatory.

2 SYSTEM CONFIGURATION

With the central remote controller, unified operation/stop is possible with up to a maximum 64 groups of indoor units. When using 2 central remote controllers, unified operation is possible with up to a maximum 128 groups. With this optional accessory, setting of control modes including operation, stop, operation controlled by timer, and ON/OFF control possible/impossible by remote controller can be set individually by zones while it enables to control and display the operation state such as set temperature. It can be connected with the external key system, host computer monitor panel, etc., through forced OFF input (no-voltage normally open contactor). A zone is a one or more groups together. In general, the same settings are used throughout a zone.

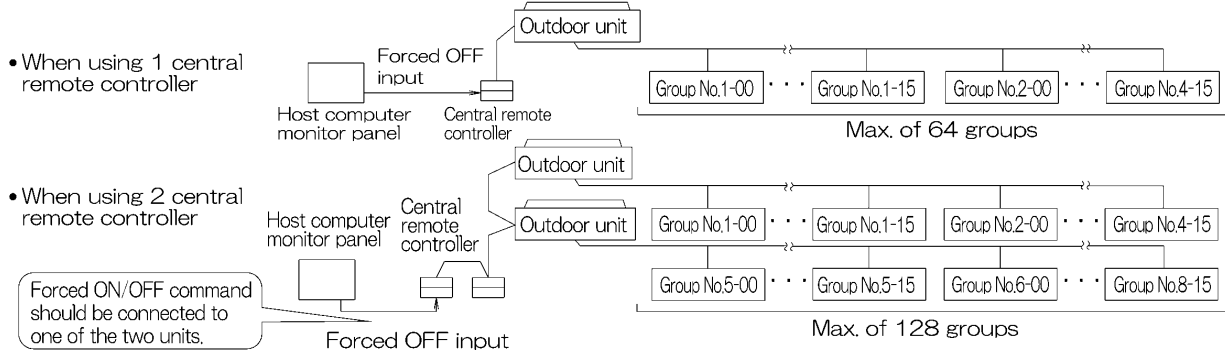

The central remote controller and the separately sold remote control adapter circuit board or group remote control adapter cannot be used together. See the D-BACS design guide for details.

3 INSTALLATION

(1) Open the upper part of remote controller. Insert a ⊖ screwdriver (2 locations) into the recess between the upper part and the lower part of remote controller and twist the screwdriver lightly.

PC board is attached with both the upper and lower part of remote controller. Do not damage the board with the screwdriver.

(2) Open the upper part of remote controller and install the Electric parts box with the attached installation screws (M4 x 16).

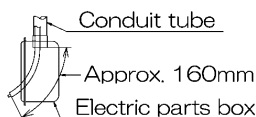

Installation screws (4)

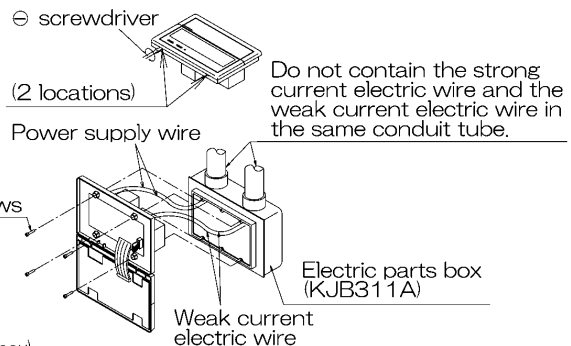

NOTE) Suitable length of the electric wire is about 160mm. (from electric parts box) If it is difficult to contain a long wiring, strip the sheathed part of the wiring.

4 INITIAL SETTING

Setting (1) through (3) are initialized when power is turned ON, therefore complete settings BEFORE activating the power. (The positions of connectors and switches used for settings in this section are shown in Fig. 1)

- (1) Connector for setting master controller (X1A) (Provided with connector at factory set)
 - When using only 1 central remote controller, do not disconnect the connector for setting master controller. (Use the unit with the connector in the state in which it was delivered.)
 - When using multiple central remote controllers, or using the central remote controller in conjunction with the optional controllers for centralized control, makes settings as indicated in the below table.

Pattern of connection of optional controllers for centralized control			Connector for setting master controller (X1A) Setting, Removed		
Central remote controller	Unified ON/OFF controller	Schedule timer	Central remote controller	Unified ON/OFF controller	Schedule timer
1 to 4	1 to 16	1	Set one to "Used" and all the rest to "Not used"	Set all to "Not used"	"Not used"
		1			"Not used"

(Remove all the connectors for the central remote controller, the on/off controller, and the schedule timer when using the unit together with the Ve-UP controller, the master station II, the DMS interface, the payment management unit, or the parallel interface station.)

- (2) Address setting
Two central remote controllers can be used as shown in **2 SYSTEM CONFIGURATION**, to control anywhere up to a max. 128 groups of indoor units. In this case, group address must be set. This is done with the switch for setting each address (SS3).

SS3 setting	Indoor unit address	SS3 setting	Indoor unit address
SETTING EACH ADDRESS 5-00 ~ 8-15	To control indoor units from group Nos. 1-00 through 4-15	SETTING EACH ADDRESS 5-00 ~ 8-15	To control indoor units from group Nos. 5-00 through 8-15

- (3) MAIN/SUB changeover switch setting
With two central remote controllers, centralized control (indoor units) is possible from different locations. In this kind of set-up, it is necessary to set the MAIN/SUB changeover switch.

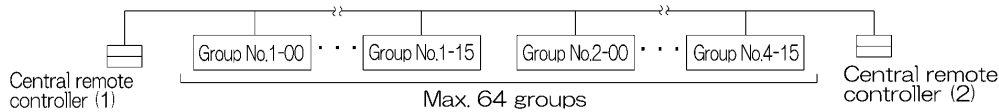

One of the two central remote controllers (1) . (2) is set to "MAIN" while the other is set to "SUB".

- (4) Setting of the sequential operation function
The central remote controller is equipped with a sequential operation function that sequentially turns indoor units on in 2-second intervals during unified operation. (Sequential operation is factory set to "ON.") To switch sequential operation ON or OFF, set as follows.

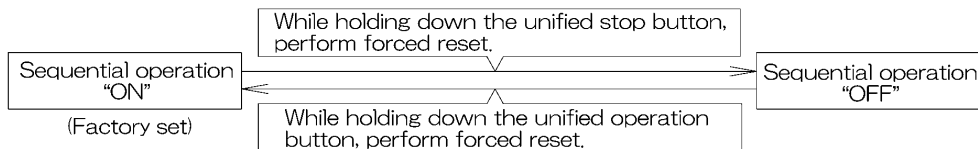

NOTE: The sequential operation function is designed to reduce the load on the power supply equipment, but does not guarantee that compressors will not be started simultaneously. You cannot therefore count on a capacity reduction effect by power supply equipment breaker selection.

- (5) Forced reset switch
When changing the setting of the connector for setting master controller, etc., you can reset simply by setting it to the reset side once and returning to the normal side, without turning the power OFF. (For normal operation, set the switch to the normal side.)

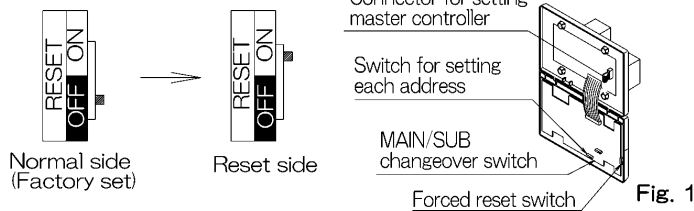
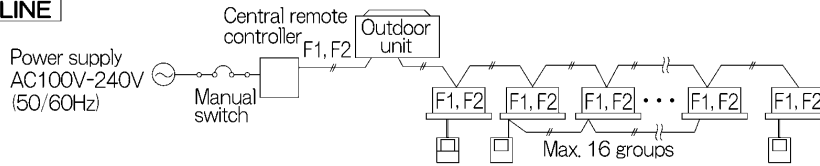

Fig. 1

5 ELECTRIC WIRING

WIRING OUTLINE



WIRING TO THE INDOOR UNIT AND OUTDOOR UNIT

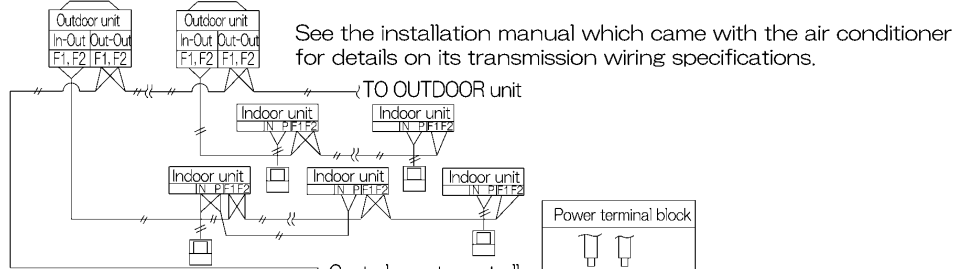

Batch remote control adapter Connector (X2A)
 Separately sold batch remote control adapter.
 Used for DCS302A72 connections.
 See the instruction manual included with the batch remote control adapter for details.

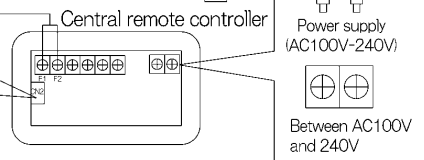

Wiring specifications

Power supply wiring	2mm ²
Transmission wiring for control	0.75 – 1.25 mm ² sheathed vinyl cord or cable (balanced type) – maximum length 1000 m (total overall wiring length 2000 m)
Manual switch	10A or 15A

Wire the indoor units to the outdoor units and between all power, indoor units, and remote controllers. See the instruction manual included with the indoor and outdoor units for details.

CONTROL TERMINAL STRIP

*1 For connecting Indoor unit (F1, F2)

*2 Forced OFF input (T1, T2)

None of the indoor units connected to the forced OFF input contact (non-voltage contact with minimal current) will operate when it is shut off.
 Use only contactors which guarantee the minimum applicable load DC 16V, 10mA.

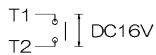

NOTE) Use instantaneous contactor of over 200m sec. energizing time, when necessary.

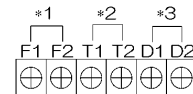

*3 For schedule timer (D1, D2)

Power can be supplied to the schedule timer (DST301B61) separately sold. For details, refer to the installation manual of the schedule timer.

Wire *2 and *3 only when necessary.

(NOTE)

Do not connect the power supply wiring (100 to 240V) to the control terminal strip. If connected by mistake, it may damage or burn electrical parts of optional controllers for centralized control and indoor unit. It may result in serious danger. Be sure to check wirings before turning the power ON.

6 SETTING GROUP NO. FOR CENTRALIZED CONTROL

Set the group number of each group of the indoor unit from the remote controller. (In case of no remote controller, also connect the remote controller and set the group No. Then, remove the remote controller.)

- (1) Turn ON the power of the indoor unit and central remote controller.

(Unless the power is ON, no setting can be made.)

Check that the installation and electrical wiring are correct before turning the power supply ON.

(When the power supply is turned ON, all LCD appear once and the unit may not accept the operation for about one minute with the display of “88”.)

- (2) While in the normal mode, hold down the “” button for a minimum of 4 seconds.

The remote controller will enter the FIELD SET MODE.

- (3) Select the MODE No. “00” with the “” button.

- (4) Use the “” button to select the group No. for each group.
(Group numbers increase in the order of 1-00,1-01,...1-15, 2-00,...8-15.)

- (5) Press “” to set the selected group No.

- (6) Press “” to return to the NORMAL MODE.

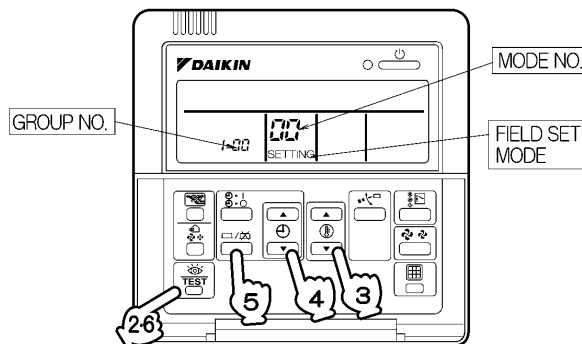

- NOTES) ● For simplified remote controller, see the installation table.
● See the instruction manuals which came with the Ventiair and adapters (i.e., multi-purpose adapters) for details on their Group No. settings.

NOTICE Enter the group No. and installation place of the indoor unit into the installation table in the operation manual. Be sure to keep the operation manual for maintenance.

7 TEST OPERATION (Perform a test operation in the individual screen before registering zones.)

Before starting test operation, check that the power is supplied to the indoor and outdoor units, and central remote controller.

- (1) Select the display “INDIVIDUALLY”

Press “” button to display “INDIVIDUALLY”

- (2) Select the group to be tested.

Select the group No. with “+” “-” “↑” “↓” button.

- (3) Press “” button to select the test operation mode.

“TEST” is displayed.

“HOST” is displayed on the remote controller.

- (4) Press “” button within 10 seconds after entering into the test operation mode.

Operation the unit for 30 minutes.

When pressing the “” button, the unit stops operating.

If the operation lamp flashes, it indicates a malfunction.

Call the group of flashing display, confirm malfunction code, and check the source of malfunction.

(The operation manual lists all error codes, so refer to it.)

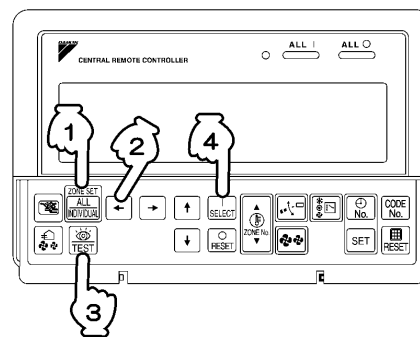

- NOTES ● For test operation, refer to the installation manual of the outdoor unit.
● After turning the power supply ON, if the unit does not accept operation for two minutes or more with the display of “88”, check the following points.
● Check that setting of the connector for setting master controller is correct.
● Check that the group No. for centralized control has been set.

2.6 <DCS302C71> Central Remote Controller (Operation)

BEFORE USE

■ GENERAL DESCRIPTION OF SYSTEM

This central remote controller can monitor and control up to 64 indoor unit groups.
Using two central remote controllers allows monitoring and controlling of up to 128 indoor unit groups.

Main Functions

1. Batch starting and stopping of indoor units connected to the central remote controller.
2. Handling of operation settings such as start/stop, timer operation, remote controller prohibition/permission, etc., and operation status settings such as temperature.
3. Operation status monitoring of operation mode, set temperature, etc.
4. Can be connected to an external central monitor panel and key system using the forced stop input (non-voltage a connector).

- When using 1 central remote controller

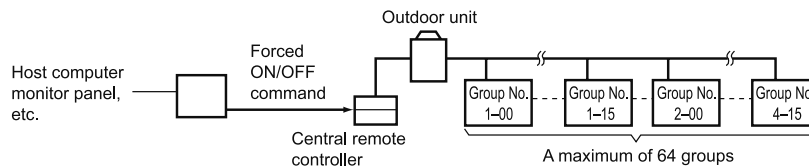

- When using 2 central remote controllers

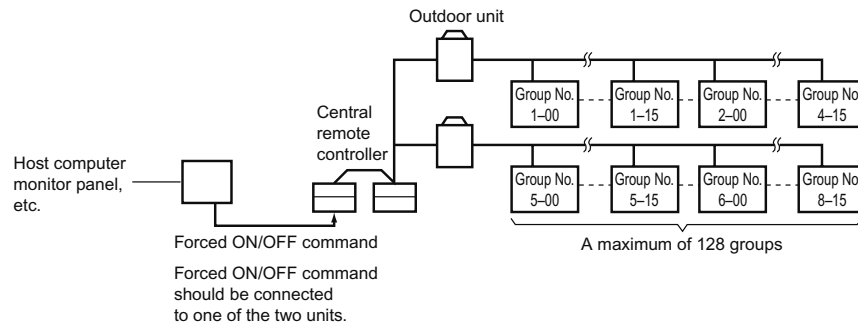

(The central remote controller and the separately sold remote control adapter circuit board or group remote control adapter cannot be used together.)

* GROUP OF INDOOR UNIT refers to the below.

1. A single indoor unit without remote controller

1. A single indoor unit without remote controller

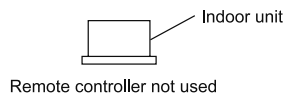

2. A single indoor unit controlled by one or two remote controllers

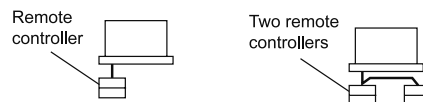

3. Maximum of 16 indoor units, group-controlled by one or two remote controllers

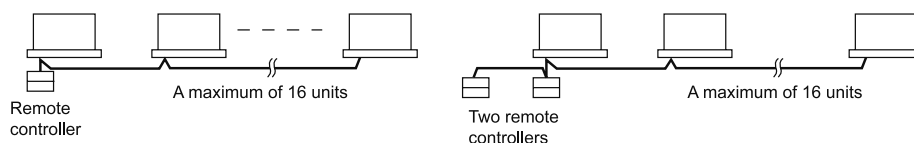

* Zone control from the central remote controller

Zone control is available from the central remote controller. With it, it is possible to make unified settings for multiple groups, so setting operations are greatly simplified.

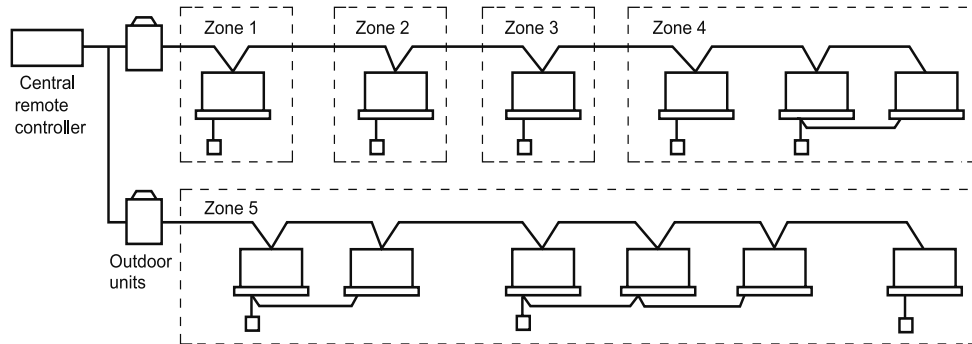

- Any setting you make within a given zone will apply to all groups in the said zone.
- A maximum of 64 zones can be set from a single central remote controller. (Each zone contains a maximum of 64 groups.)
- Zones can be set randomly from the central remote controller.

SAFETY CONSIDERATIONS

Please read these "SAFETY CONSIDERATIONS" carefully before installing air conditioning equipment and be sure to install it correctly. After completing the installation, make sure that the unit operates properly during the start-up operation. Please instruct the customer on how to operate the unit and keep it maintained. Also, inform customers that they should store this installation manual along with the operation manual for future reference. This air conditioner comes under the term "appliances not accessible to the general public".

Meaning of danger, warning, caution and note symbols.

- ⚠ DANGER** Indicates an imminently hazardous situation which, if not avoided, will result in death or serious injury.
- ⚠ WARNING** Indicates a potentially hazardous situation which, if not avoided, could result in death or serious injury.
- ⚠ CAUTION** Indicates a potentially hazardous situation which, if not avoided, may result in minor or moderate injury. It may also be used to alert against unsafe practices.
- ⚠ NOTE**..... Indicates situation that may result in equipment or property-damage-only accidents.

Keep these warning sheets handy so that you can refer to them if needed.

Also, if this equipment is transferred to a new user, make sure to hand over this operation manual to the new user.

⚠ DANGER

- Any abnormalities in the operation of the air conditioner such as smoke or fire could result in severe injury or death. Turn off the power and contact your dealer immediately for instructions.
- **Do not install the unit in an area where flammable materials are present due to risk of explosion resulting in serious injury or death.**
- **Safely dispose of the packing materials.** Packing materials, such as nails and other metal or wooden parts, may cause stabs or other injuries. Tear apart and throw away plastic packaging bags so that children will not play with them. Children playing with plastic bags face the danger of death due to suffocation.

⚠ WARNING

- **Ask your dealer for installation of the air conditioner.** Incomplete installation performed by yourself may result in a water leakage, electric shock, and fire.
- **Ask your dealer for improvement, repair, and maintenance.** Incomplete improvement, repair, and maintenance may result in a water leakage, electric shock, and fire.
- **Improper installation or attachment of equipment or accessories could result in electric shock, short-circuit, leaks, fire or other damage to the equipment. Be sure only to use accessories made by Daikin which are specifically designed for use with the equipment and have them installed by a professional.**
- **Ask your dealer to move and reinstall the air conditioner or the remote controller.** Incomplete installation may result in a water leakage, electric shock, and fire.
- **Never let the indoor unit or the remote controller get wet.** It may cause an electric shock or a fire.

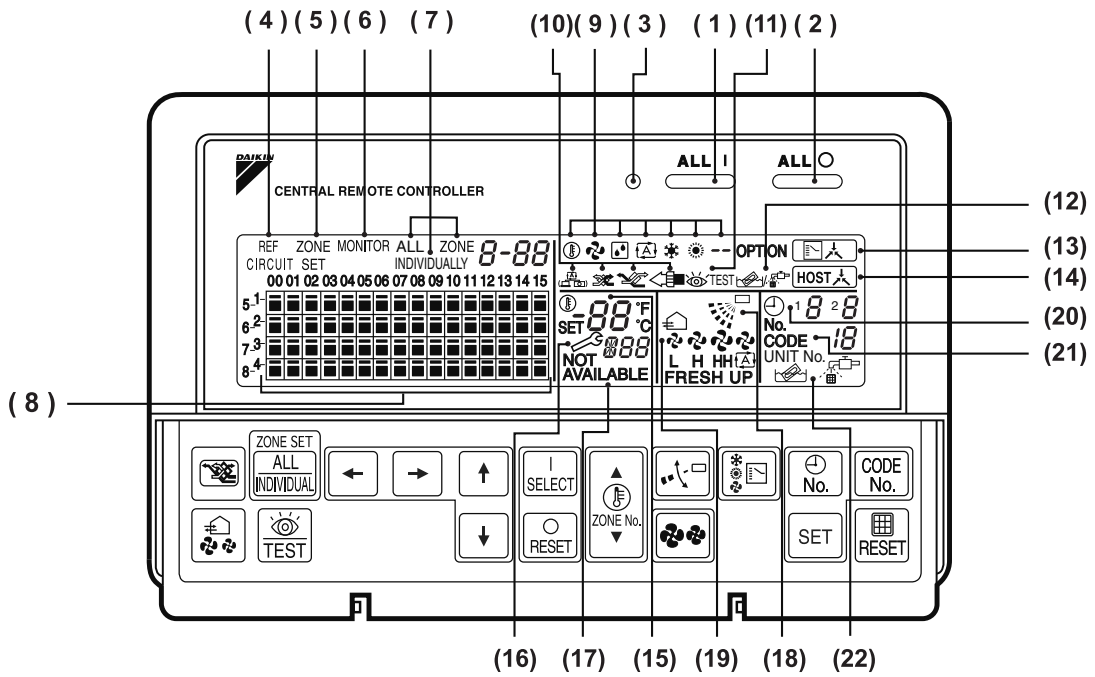

Fig. 1

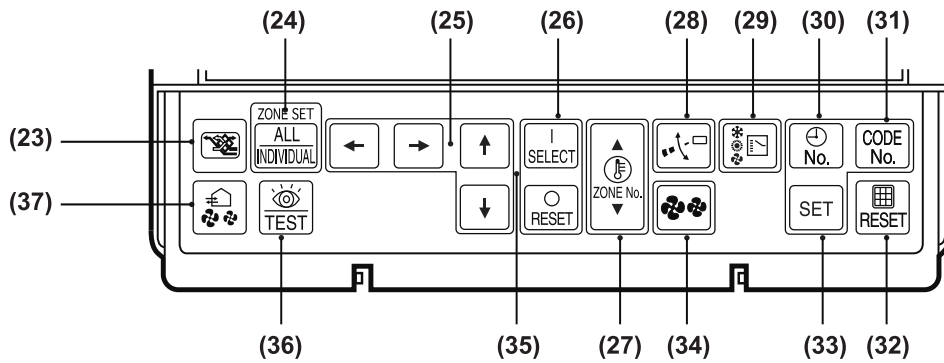

Fig. 2

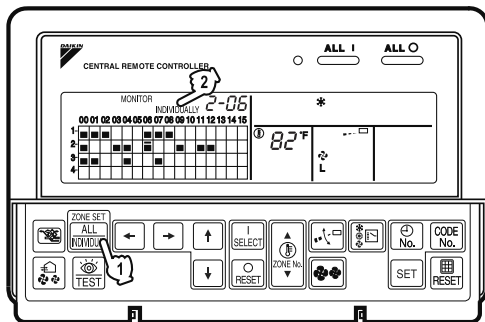

Fig. 3

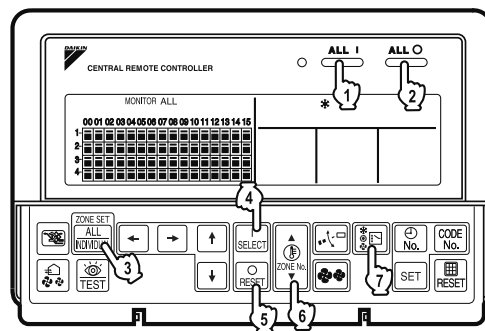

Fig. 4

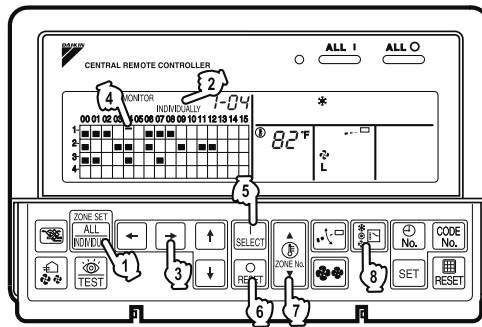

Fig. 5

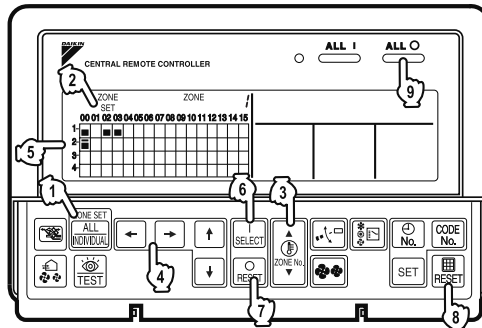

Fig. 6

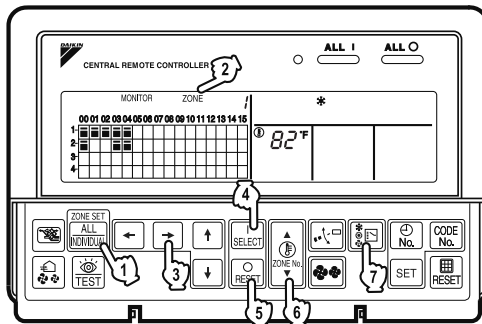

Fig. 7

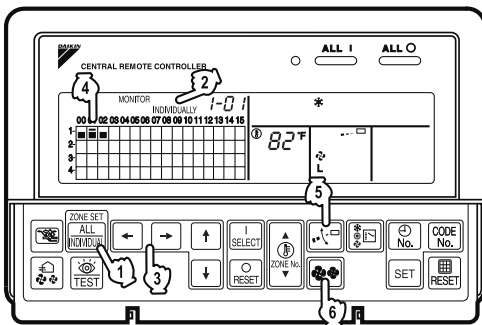

Fig. 8

- **Never use flammable spray such as hair spray, lacquer or paint near the unit.**
It may cause a fire.
- **Do not allow children to play on or around the unit as they could be injured.**
- **Never replace a fuse with that of wrong ampere ratings or other wires when a fuse blows out.**
Use of wire or copper wire may cause the unit to break down or cause a fire.
- **Never inspect or service the unit by yourself.**
Ask a qualified service person to perform this work.
- **Cut off all electric waves before maintenance.**
- **Do not wash the air conditioner or the remote controller with excessive water.**
Electric shock or fire may result.
- **Do not touch the switch with wet fingers.**
Touching a switch with wet fingers can cause electric shock.
- **Never touch the internal parts of the controller.**
Do not remove the front panel because some parts inside are dangerous to touch. In addition, some parts may be damaged by touching. For checking and adjusting internal parts, contact your dealer.
- **Check the unit stand for damage on a continuous basis, especially if it had been in use for a long time.**
If left in a damaged condition the unit may fall and cause injury.
- **Placing a flower vase or other containers with water or other liquids on the unit could result in a shock hazard or fire if a spill occurs.**

CAUTION

- **Avoid placing the controller in a spot splashed with water.**
Water coming inside the machine may cause an electric leak or may damage the internal electronic parts.

- **Do not operate the air conditioner when using a room fumigation - type insecticide.**
Failure to observe could cause the chemicals to become deposited in the unit, which could endanger the health of those who are hypersensitive to chemicals.
- **Do not turn off the power immediately after stopping operation.**
Always wait at least five minutes before turning off the power. Otherwise, water leakage and trouble may occur.
- **The appliance is not intended for use by young children or infirm persons without supervision.**
- **The remote controller should be installed in such a way that children cannot play with it.**

NOTE

- **Never press the button of the remote controller with a hard, pointed object.**
The remote controller may be damaged.
- **Never pull or twist the electric wire of the remote controller.**
It may cause the unit to malfunction.
- **Do not place the controller exposed to direct sunlight.**
The LCD display may get discolored, failing to display the data.
- **Do not wipe the controller operation panel with benzene, thinner, chemical dustcloth, etc.**
The panel may get discolored or the coating peeled off. If it is heavily dirty, soak a cloth in water-diluted neutral detergent, squeeze it well and wipe the panel clean. And wipe it with another dry cloth.
- **Dismantling of the unit, treatment of the refrigerant, oil and eventual other parts, should be done in accordance with the relevant local and national regulations.**

CONTENTS

BEFORE USE	1	OPERATION MODE	13
GENERAL DESCRIPTION OF SYSTEM	1	Setting operation mode	16
SAFETY CONSIDERATIONS	2	Group monitoring	16
FEATURES AND FUNCTIONS	6	Error diagnosing function	17
NAMES AND FUNCTIONS OF THE		Setting master remote controller	20
OPERATING SECTION	7	Display of time to clean	21
OPERATION	8	INSTALLATION TABLE	22
Individual screen, all screen, zone screen	8	OPTIONAL ACCESSORIES	23
Batch operation and stop method	9	DOUBLE CENTRAL REMOTE	
Group operation and stop method	9	CONTROLLERS	23
Registering zones	9	SPECIFICATIONS	24
Zone operation and stop method	10	Specifications	24
Changing the fan direction and fan strength	11	Outline drawings	24
Changing the ventilation mode and			
ventilation strength	11	Fig. 1, 2, 3, 4	3
Timer Number Setting	11	Fig. 5, 6, 7, 8	4
Setting the Operation Code	12	Fig. 9, 10, 11, 12	25
		Fig. 13, 14, 15, 16	26

FEATURES AND FUNCTIONS

■ Operation menu

This central remote controller can operate and stop machines by either group or zone.
Batch operation and batch stop functions are also available. When used in combination with the schedule timer (optional accessory), timer operation and stop functions are available.



See page
8—12.

■ Various operation modes.

You can operate the system from both this unit and the remote controller, so to enable various operation control patterns. Twenty different operation modes are available including five operation patterns:

1. Start/stop: remote controller prohibition, remote controller stop-only permission, central priority, after-press priority, remote controller permission timer
2. Operation modes: remote controller prohibition, remote controller permission
3. Set temperature: remote controller prohibition, remote controller permission



See page
13—15.

■ Zone control for simpler setting procedures

You can control a maximum of 64 groups of indoor units by using this central remote controller. You don't have to repeat the same setting operations by group because you can make each of the following settings by zone.

A functions is available for setting all groups in one batch.

- Operation mode
- Control mode
- Setting temperature
- Programming time No. (Used in conjunction with the schedule timer)



See page
8—16.

■ Monitoring all indoor unit information

The following information can be displayed by group.

- Operation information such as operation mode, set temperature, etc., for indoor units
- Maintenance information such as cleaning signs for filters or elements
- Error codes and other malfunction diagnosis information



See page
16—21.

■ Function of refrigerant system display











This display helps you understand, at a glance, the indoor units sharing the same outdoor unit and the particular indoor unit among them that is set as the master remote controller.





See page 20.

- Room air conditioners and multi-purpose air conditioners may also be connected by using separately-sold adapter boards.
This may limit functionality, so consult the manuals that come with each adapter board.

NAMES AND FUNCTIONS OF THE OPERATING SECTION (Fig. 1, 2)

1	UNIFIED OPERATION BUTTON	Press to operate all indoor units.	13	 DISPLAY (COOLING/HEATING SELECTION PRIVILEGE NOT SHOWN)	For zones or individual units (groups) for which this is displayed, cooling and heating cannot be selected.
	UNIFIED STOP BUTTON	Press to stop all indoor units.		14	 DISPLAY (UNDER HOST COMPUTER INTEGRATED CONTROL)
2	OPERATION LAMP (RED)	Lit white any of the indoor units under control is in operation.	15		 DISPLAY (PRESET TEMPERATURE)
	"REF CIRCUIT" DISPLAY (REFRIGERANT SYSTEM DISPLAY)	This indication in the square is lit while the refrigerant system is being displayed.		16	 DISPLAY (MALFUNCTION CODE)
3	"ZONE SET" DISPLAY (ZONE SETTING)	The lamp is lit while setting zones.	17		"NOT AVAILABLE" DISPLAY (NO FUNCTION DISPLAY)
	"MONITOR" DISPLAY (OPERATION MONITOR)	The lamp is lit while operation is being monitored.		18	 DISPLAY (FAN DIRECTION SWING DISPLAY)
4	"ALL" "ZONE" "INDIVIDUALLY" DISPLAY	The status displays indicates either batch functions or which zone or individual unit (or group) are being used.	19		 DISPLAY (VENTILATION STRENGTH/SET FAN STRENGTH DISPLAY)
	OPERATION MONITOR	Each square displays the state corresponding to each group.		20	 DISPLAY (TIME NO.)
5	 DISPLAY (OPERATION MODE)	Displays operating state.	12		 DISPLAY (TIME TO CLEAN)
	 DISPLAY (VENTILATION CLEANING DISPLAY)	This is displayed when a Ventiair total enthalpy heat exchanger unit or other such unit is connected.			
6	 DISPLAY (INSPECTION/TEST)	Pressing the maintenance/test run button (for service) displays this. This button should not normally be used.			

21	<p>“CODE UNIT No. 18” DISPLAY (OPERATION CODE AND UNIT NUMBER DISPLAY)</p> <p>The method of operation (remote controller prohibited, central operation priority after-press operation priority, etc.) is displayed by the corresponding code. This displays the numbers of any indoor units which have stopped due to an error.</p>
	<p>“” “” DISPLAY (TIME TO CLEAN AIR CLEANER ELEMENT/ TIME TO CLEAN AIR FILTER)</p> <p>Displayed to notify the user it is time to clean the air filter or air cleaner element of the group displayed.</p>
23	<p>VENTILATION MODE BUTTON</p> <p>This is pressed to switch the ventilation mode of the total enthalpy heat exchanger.</p>
24	<p>ALL/INDIVIDUAL BUTTON</p> <p>Pressing this button scrolls through the “all screen”, “zone screen”, and “individual screen”.</p>
25	<p>ARROW KEY BUTTON</p> <p>This button is pressed when calling an individual indoor unit or a zone.</p>
26	<p>ON/OFF BUTTON</p> <p>Starts and stops ALL, ZONE, and INDIVIDUAL units.</p>
27	<p>TEMPERATURE ADJUSTMENT BUTTON (ZONE NUMBER BUTTON)</p> <p>This button is pressed when setting the temperature. Select the zone number if any zones have been registered.</p>
	<p>FAN DIRECTION ADJUSTMENT BUTTON</p> <p>This button is pressed when setting the fan direction to “fixed” or “swing”.</p>
29	<p>OPERATION MODE SELECTOR BUTTON</p> <p>This sets the operation mode. The dry setting cannot be done.</p>
30	<p>TIME NO. BUTTON</p> <p>Selects time No. (Use in conjunction with the schedule timer only).</p>
31	<p>CONTROL MODE BUTTON</p> <p>Selects control mode.</p>
32	<p>FILTER SIGN RESET BUTTON</p> <p>This button is pressed to erase the “clean filter” display after cleaning or replacement.</p>

33	<p>SET BUTTON</p> <p>Sets control mode and time No.</p>
34	<p>FAN STRENGTH ADJUSTMENT BUTTON</p> <p>Pressing this button scrolls through “weak”, “strong”, and “fast”.</p>
	<p>ZONE SETTING BUTTON</p> <p>Zone registration mode can be turned on and off by pressing the start and stop buttons simultaneously for at least four seconds.</p>
36	<p>INSPECTION/TEST RUN BUTTON (FOR SERVICE)</p> <p>Pressing this button scrolls through “inspection”, “test run”, and “system display”. This button is not normally used.</p>
37	<p>VENTILATION STRENGTH ADJUSTMENT BUTTON</p> <p>This button is pressed to switch the ventilation strength (“fresh up”) of the total enthalpy heat exchanger.</p>
	<p>(Notes)</p> <ol style="list-style-type: none"> Please note that all the displays in the figure appear for explanation purposes or when the cover is open. If the unit is used in conjunction with other optional central controllers, the OPERATION LAMP of the unit that is not under operation control may light up and go out a few minutes behind schedule. This shows that the signal is being exchanged, and does not indicate any failure.

OPERATION

■ Individual screen, all screen, zone screen (Fig. 3)

This controller can perform operations in the individual screen, all screen, or zone screen.

- Individual screen The individual screen is used when performing group operations.
- All screen The all screen is used when performing operations for all units at once.
- Zone screen The zone screen is used when performing zone operations.

1. Select the screen by pressing the “ALL/INDIVIDUAL” button.

 Every time the “ALL/INDIVIDUAL” button is pressed, the selection scrolls through INDIVIDUAL → ALL → ZONE.

If nothing is done in the all or zone screens for one minute, it automatically goes to the individual screen.

- If the zone number in the zone screen is displayed as “--,” this indicates that no units are registered in a zone.
Please perform zone registration before proceeding in the zone screen. (See page 9)

■ Batch operation and stop method (Fig. 4)

This is for operating or stopping all connected units at once.

A. What to do when operating or stopping all connected units at once.

1. Press either “ALL I” or

 “ALL O”.

- Operation can be performed from the individual screen, the all screen, or the zone screen.
- The “TEMPERATURE ADJUSTMENT” and “OPERATION MODE SELECTOR” buttons cannot be used.
To set the temperature and operation mode, use B. batch operation.

B. Batch Operation

1. Press the “ALL/INDIVIDUAL button” to enter the all screen.

The “” display lights up on all registered units.

2. Press the “SELECT” button.

The “” display lights up on all connected units.

 Press the “RESET” button.

The “” display goes off on all connected units.
Operation and stop in the batch screen are done the same as with the batch operation and batch stop buttons.

3. Press the “TEMPERATURE ADJUSTMENT” button.

The temperature rises 1° every time the (▲) button is pressed.
The temperature drops 1° every time the (▼) button is pressed.

Set to “--” when you do not wish to use batch setting for the temperature setting.
Setting to 1° above or below the temperature setting range displays “--”.

4. Call up the desired mode by pressing the “OPERATION MODE SELECTOR” button.

Set to “--” when you do not wish to use batch setting for the operation setting.

■ Group operation and stop method (Fig. 5)

This is for operating or stopping connected units in groups.

[Group operation]

1. Press the “ALL/INDIVIDUAL button” to enter the individual screen.

The unit will enter the individual screen automatically if nothing is done for one minute.

2. Using the arrow keys, move the “” to select the units to operate or stop.

Keeping the button pressed down will move it rapidly.

The “” in this screen has selected unit 1-04.

3. Press the “SELECT” button.

The “” display lights up in the group.

 Press the “RESET” button.

The “” display goes off in the group.

4. Press the “TEMPERATURE ADJUSTMENT” button.

The temperature rises 1° every time the (▲) button is pressed.

The temperature drops 1° every time the (▼) button is pressed.

Temperature adjustment cannot be done if the selected group’s air conditioners are in fan mode.

5. Call up the desired mode by pressing the “OPERATION MODE SELECTOR” button.

■ Registering zones (Fig. 6)

It is possible to set multiple groups as one zone and control each zone separately.

No zones are registered when the unit is shipped from the factory.

Zone registration can be done in the individual screen, all screen, or zone screen.

[Registration]

1. Pressing the “ALL/INDIVIDUAL” button for four seconds. Displays ZONE SET.

Zone Number 1 will be displayed, and if there are any groups already registered in the displayed zone, a “” will light up on the operation monitor.

2. Select the Zone Number to be registered using the “ZONE NUMBER” button. Keeping the button pressed down will move it rapidly.
3. “” to the group you wish to register using the arrow keys. Keeping the button pressed down will move it rapidly.
4. Press the “SELECT” button to register that group to the zone.

The “” display lights up on all the selected units.

Pressing the “RESET” button removes the group from that zone, and “” goes off.

Repeat steps 3 and 4 until all the units you wish to register to the zone have been added.

	ZONE SET					ZONE										
	00	01	02	03	04	05	06	07	08	09	10	11	12	13	14	15
1-																
2-																
3-																
4-																

In this example, a screen is shown with units 1-00, 1-02, 1-03, and 2-00 registered to Zone Number 1.

5. Repeat steps 2 to 4 to register to the next zone.
6. Once zone registration is complete, press the “ALL/INDIVIDUAL” button to turn off “ZONE SET” display and return to the individual screen.

The display returns to the normal screen if nothing is done for one minute when in zone registration mode.

(NOTE)

- It is impossible to register one group to several different zones.
If this is done, the last zone registered to will be valid.

[Batch deletion of zone registration]

1. Pressing the “ALL ○” for at least four seconds while pressing the “FILTER SIGN RESET” button when “ZONE SET” is displayed will delete all zone registrations.
The zone registrations for all units will be lost.

■ Zone operation and stop method (Fig. 7)

This is for operating or stopping connected units in zones.

[Zone operation]

1. Press the “ALL/INDIVIDUAL button” to enter the zone screen.
2. Using the arrow keys, select the zone number to operate or stop.

Pressing and reduces the zone number while and raise the number.

Keeping the button pressed down will move it rapidly.

- If the zone number is displayed as “--,” this indicates that no units are registered in a zone. Please perform zone registration before using a zone. (See page 9)

3. Press the “SELECT” button.

The “” display lights up in the group.

4. Press the “RESET” button.

The “” display goes off in the group.

4. Press the “TEMPERATURE ADJUSTMENT” button.

The temperature rises 1° every time the (▲) button is pressed.

The temperature drops 1° every time the (▼) button is pressed.

Set to “--” when you do not wish to use zone setting for the temperature setting.

Setting to 1° above or below the temperature setting range displays “--”.

5. Call up the desired mode by pressing the “OPERATION MODE SELECTOR” button.

Set to “--” when you do not wish to use zone setting for the operation mode.

■ Changing the fan direction and fan strength (Fig. 8)

This changes the fan direction and strength settings in the air conditioner.

Changing the fan direction and strength is done in the individual screen.

[Registration]

1. Press the “ALL/INDIVIDUAL button” to enter the individual screen.

The unit will enter the individual screen automatically if nothing is done for one minute.

2. Using the arrow keys, move the “” to select the units to fan direction adjustment or fan strength adjustment.

Keeping the button pressed down will move it rapidly.

3. Press the “FAN DIRECTION ADJUSTMENT” button.

This sets “fixed” or “swing” for the fan direction.

4. Press the “FAN STRENGTH ADJUSTMENT” button.

Pressing this button scrolls through “”, “”, and “”.

Depending on the indoor unit, only “” and “” may be available.

The functions included in the indoor units may vary. Pressing a button for a function which is not available will cause “NOT AVAILABLE” to be displayed.

■ Changing the ventilation mode and ventilation strength (Fig. 9)

This changes the ventilation mode and strength settings in the total enthalpy heat exchanger.

Changing the ventilation mode and strength is done in the individual screen.

[Registration]

1. Press the “ALL/INDIVIDUAL button” to enter the individual screen.

The unit will enter the individual screen automatically if nothing is done for one minute.

2. Using the arrow keys, move the “” to select the units to ventilation mode or ventilation strength adjustment.

Keeping the button pressed down will move it rapidly.

3. Press the “VENTILATION MODE” button.

It will scroll through “” → “” → “” → “”.

4. Press the “VENTILATION STRENGTH ADJUSTMENT” button.

It will scroll through “” → “” → “” →

“” → “”.

The fresh up function may not be available depending on the connected unit model.

The functions included in the indoor units may vary. Pressing a button for a function which is not available will cause “NOT AVAILABLE” to be displayed.

• Ventilation Mode and Amount

If these are changed using the remote controller depending on the unit model, they cannot be displayed on the central remote controller.

To monitor the ventilation mode and amount, check the values on the remote controller.

■ Timer Number Setting (Fig. 10)

(Only when used with the schedule timer)

Using this together with the schedule timer makes it possible to set on and off times four times a day.

[Registration]

1. Pressing the “TIMER NO.” button causes the number set for timer number 1 to blink.

If no timer setting has been made “-” will be displayed.

Select the desired timer number by pressing the “TIMER NO.” button.

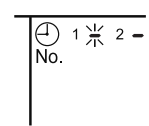

2. Once the desired timer number is displayed, press the “SET” button.

Press the “SET” button within 10 seconds after the timer number is displayed.

The display will return to how it was after 10 seconds.

The display for timer number 1 will stop blinking and then timer number 2 will start blinking.

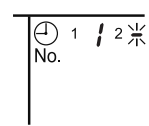

3. Select the desired timer number by pressing the “TIMER NO.” button.

Once the desired timer number is displayed,  press the “SET” button.

The display for timer number 2 will stop blinking.

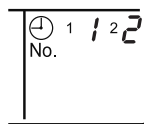

The “ No.” display will disappear after 3 seconds.

Select “-” in the timer number when you do not wish to set a timer number.

It is possible to set only one timer number. (The times for turning the unit(s) on and off twice a day can be set with a single timer number.)

• **Timer Number Setting**

Group control: select the unit in the individual screen and set the timer number.

Batch control: set the timer numbers for all connected units.

Zone control: set the timer numbers for all zone-registered units.
Call up the zones which you wish to set in the zone screen and set the timer numbers.

- **Since the timer number will be set to after-press priority, the timer number in the last screen set will be valid for the connected units.**

Example 1

Setting timer number 1 for unit 1-00 to “1” and timer number 2 to “2” in the individual screen and then setting timer number 1 to “3” and timer number 2 to “4” in the batch screen causes the timer numbers for all units to be set, so timer number 1 for unit 1-00 will be “3” and timer number 2 will be “4”.

Example 2

To prevent leaving units on, timer number 1 is set to “5” in the batch screen.

Setting timer number 1 in zone number 1 to “-” in the zone screen after that will change the timer number for zone number 1, so the setting to prevent leaving the units on will be lost for zone number 1 only.

If a timer number is set incorrectly by accident, redo the setting in the desired screen.

- **What happens when the timer number on time and off time are set to the same time**

When the on time and off time are set to the same time for the same timer number, operation does not change.

When the on time and off time are set to the same time for different timer numbers, the off time is given priority.

When using timer operation, make sure the times do not overlap when setting the program of the schedule timer.

■ **Setting the Operation Code (Fig. 11)**

[Registration]

1.  Pressing the “CONTROL MODE” button causes the currently set operation code to blink.

Call up the desired code number by pressing the  “CONTROL MODE” button.

Scroll through the code numbers.

2.  Once the code number is displayed, press the “SET” button.

The display will stop blinking.

The operation code display will disappear after 3 seconds.

[The Operation Code Setting]

Group control: select the unit in the individual screen and set the operation code.

Batch control: set the operation code for all connected units.

Zone control: set the operation code for all zone-registered units.
Call up the zones which you wish to set in the zone screen and set the operation code.

Since the operation code will be set for after-press priority, setting the operation code in the zone and individual screens after setting the operation code in the batch screen, will cause the operation codes set afterwards to be valid.

OPERATION MODE

The following five operation control modes can be selected along with the temperature setting and operation mode by remote controller, for a total of twenty different modes. These twenty modes are set and displayed with control modes of 0 to 19. (For further details, see **EXAMPLE OF OPERATION SCHEDULE** on the next page.)

- ON/OFF control impossible by remote controller..... Use this mode when operating and stopping from the central remote controller only. (ON/OFF control by the remote controller is disabled.)
- Only OFF control possible by remote controller Use this mode when executing the operation only by the central remote controller, and executing only the stop by remote controller.
- Centralized Use this mode when executing the operation only by the central remote controller, and executing start/stop freely by remote controller during the preset hours.
- Individual Use this mode when executing start/stop both by central remote controller and remote controller.
- Timer operation possible by remote controller..... Use this mode when executing start/stop by remote controller during the preset hours, and not starting operation by the central remote controller at the programmed time of system start.

[HOW TO SELECT THE CONTROL MODE]

- Select whether to accept or to reject the operation from the remote controller regarding the operation, stop, temperature setting and operation mode setting, respectively, and determine the particular control mode from the rightmost column of the table below.

Example

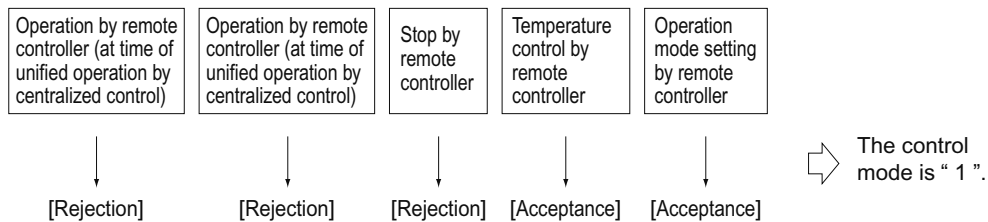

Operation mode	Control by remote controller					Control mode
	Operation		Stop	Temperature control	Operation mode setting	
	Unified operation, individual operation by central remote controller, or operation controlled by timer	Unified stop, individual stop by central remote controller, or timer stop				
ON/OFF control impossible by remote controller	Rejection (Example)	Rejection (Example)	Rejection (Example)	Rejection	Acceptance	0
Only OFF control possible by remote controller				Acceptance (Example)	Acceptance (Example)	1 (Example)
Centralized	Acceptance	Acceptance	Acceptance	Rejection	Acceptance	2
Individual				Acceptance	Rejection	3
				Rejection	Acceptance	4
Timer operation possible by remote controller				Acceptance (During timer at ON position only)	Rejection (During timer at OFF position)	Acceptance
				Acceptance	Rejection	6
				Rejection	Acceptance	7
				Acceptance	Rejection	8
				Rejection	Acceptance	9
				Acceptance	Rejection	10
				Rejection	Acceptance	11
				Acceptance	Rejection	12
				Rejection	Acceptance	13
				Acceptance	Rejection	14
				Rejection	Acceptance	15
				Acceptance	Rejection	16
				Rejection	Acceptance	17
				Acceptance	Rejection	18
				Rejection	Acceptance	19

Note) Do not select the timer operation possible without the remote controller. In this case, timer operation is disabled.

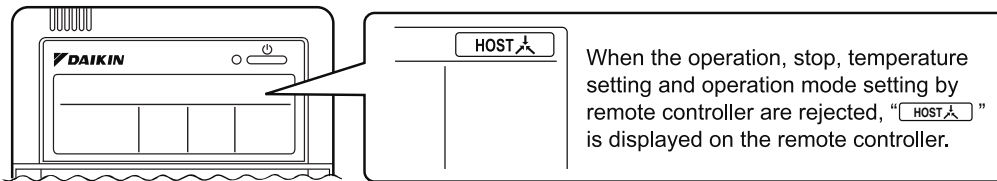

EXAMPLE OF OPERATION SCHEDULE

Operation schedule is possible only in conjunction with the schedule timer (optional accessory).

Liquid crystal display of schedule timer

ON/OFF control impossible by remote controller

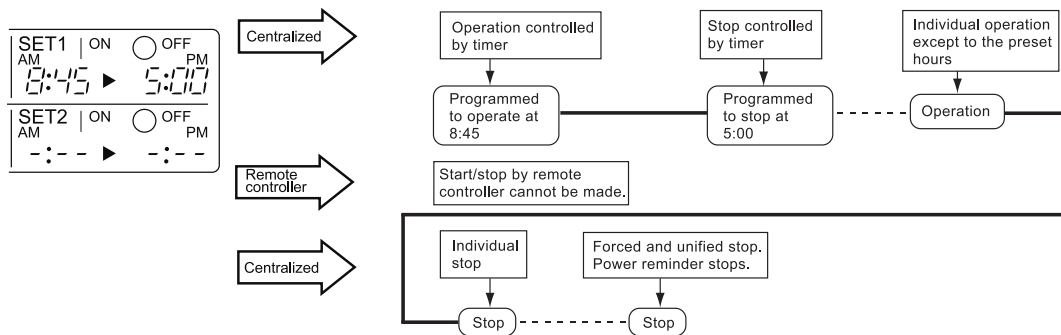

Only OFF control possible by remote controller

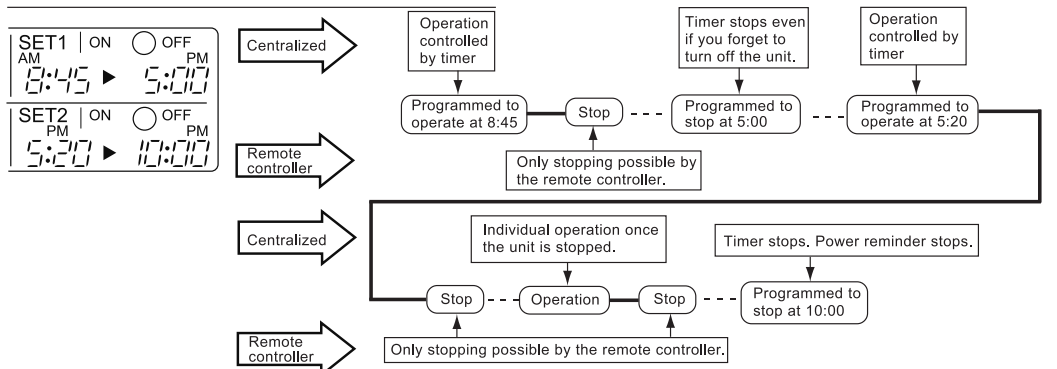

Centralized

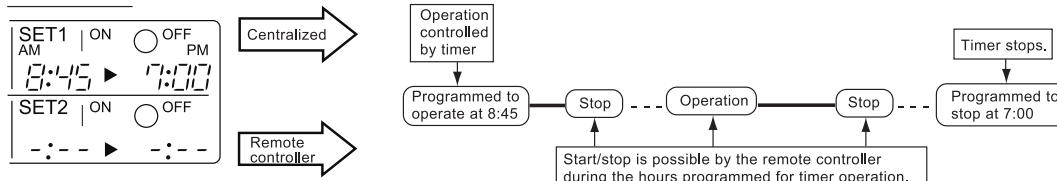

Individual

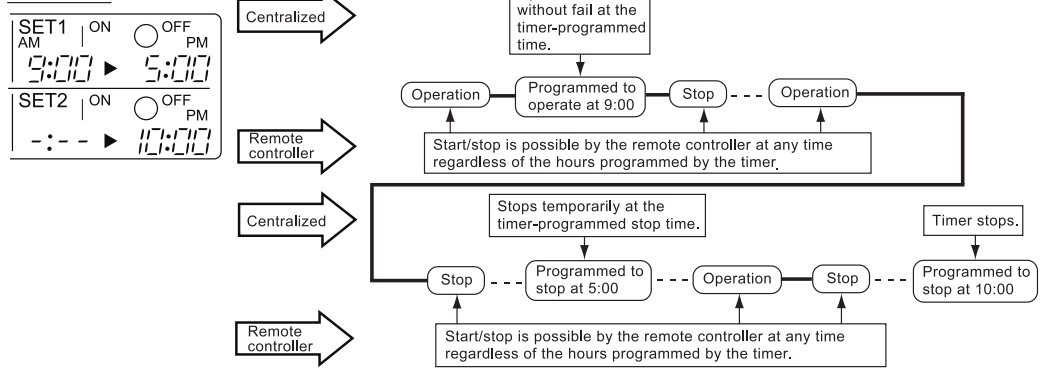

Timer operation possible by remote controller

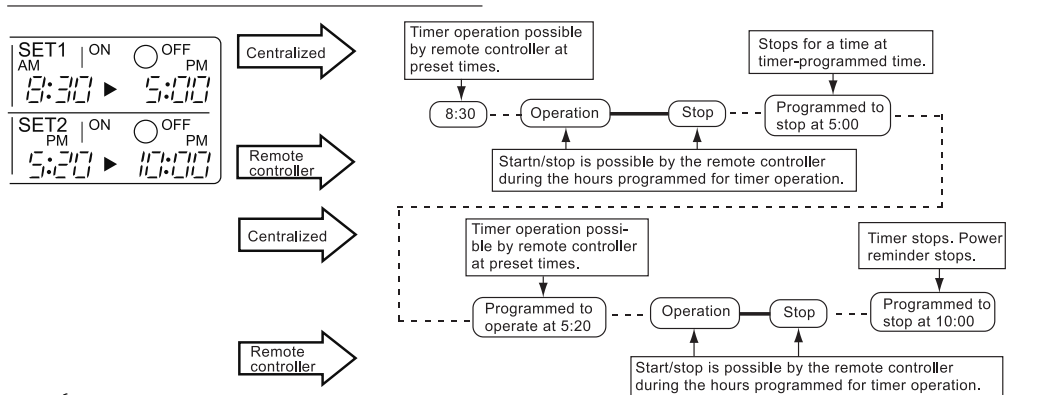

- Air conditioner now operating.
- - - - Air conditioner now stopping.
- ▭ Command by central remote controller
- Command by remote controller

■ Setting operation mode (Fig. 12)

[Registration]

1. Press the OPERATION MODE SELECTOR BUTTON. Each time you press this button, the display rotates as shown on the below list.

- List of operations which can be set
In the below list, “○” refers to the acceptable setting, while “×” refers to the not acceptable setting.

Display	A: Zones and groups with no “ ” display.	
	Setting	Contents of setting
	×	
	○	Can be set in individual zones or groups
	○ * 1	Can be set in individual zones or groups
	○	Can be set in individual zones or groups
	○	Can be set in individual zones or groups
	○ * 1	Can be set in individual zones or groups * 3
	○ * 1	Can be set in individual zones or groups
	○	Select this display if you don't wish to set by zone.

Display	B: Zones and groups with a “ ” display.	
	Setting	Contents of setting
	○	To be set by zone * 2
	○	Can be set in individual zones or groups
	×	
	×	The displays are shown by group * 4
	×	The displays are shown by group * 4
	○ * 1	Can be set in individual zones or groups * 3
	○ * 1	Can be set in individual zones or groups
	○	Select this display if you don't wish to set by zone.

- *1: Setting may not be acceptable depending on the type of indoor unit with which this unit is connected.
- *2: In zone control, the units run in temperature adjustment mode (heating or cooling) for the outdoor system for the groups registered to those zones. Heating or cooling selection is not available.
- *3: Changing the ventilation mode cannot be done in the zone screen. Changing the ventilation mode should be done in the individual screen.
- *4: In group control, the units run in temperature adjustment mode (heating or cooling) for the group outdoor system. Heating or cooling selection is not available.

• The Zone consists of the following two cases.

A. Zone without display “ ”

The group with master remote controller setting exists in this zone.
Setting the master remote controller enables cool/heat selection.
Operations other than cool/heat operations can also be set for some operations. For further details, see the list on the left.

B. Zone with display “ ”

No group with master remote controller setting exists in this zone.
The cool/heat selection is not available because the master remote controller has not been set.
Some operations other than cool/heat operations can be set. For further details, see the list in the left.

See page 20 if the display “ ” is flashing.

- Fan operation can be performed for each zone using the central remote controller even if there is no cooling/heating selection right during cooling or heating. Also, if a VentiAir is connected in the zone, ventilation and ventilation cleaning operation is possible. See the included operating manuals for details.
- When the indoor unit is in heat operation, change the setting to FAN operation through the central remote controller; then, you can switch the fan speed to the extremely low fan speed. Warm air may blow if any other indoor unit belonging to the same system is in heat operation.
- The indoor fan stops during defrost/hot start.
- DRY cannot be set from the central remote controller.

■ Group monitoring (Fig. 13)

Utilize the group monitor function in each of the following cases:

1. Check the malfunction code. (See the next page.)
2. Check the group that requires cleaning of the air filter and air cleaner element. (See page 21.)
3. Change the setting of the master remote controller. (See page 20.)
4. Check the group(s) sharing the same outdoor unit. Or, check the particular group(s) with the master remote controller setting. (See page 20.)
5. Check the conditions of other individual groups.

When in zone screen

The zone screen will revert to the individual screen automatically if nothing is done in it for one minute.

[Registration]

1. Press the “ALL/INDIVIDUAL” button to switch to the “INDIVIDUAL” screen.

2. Using the arrow key, move the “ ” to select the unit to be monitored.

Keeping the button pressed down will move it rapidly.

The “ ” lights up and the status of that unit is displayed in the LCD. The cursor in the screen Fig. 13 has selected unit 2-06.

■ Error diagnosing function

(Fig. 14)

This central remote controller is provided with a diagnosing function, for when an indoor unit stops due to malfunction. In case of actuation of a safety device, disconnection in transmission wiring for control or failure of some parts, the operation lamp, inspection display and unit No. start to flash; then, the malfunction

code is displayed. Check the contents of the display, and contact your DAIKIN dealer because the above signs can give you the idea on the trouble area.

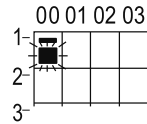

The display “ ” flashes under the group No. where the indoor unit that has stopped due to malfunction.

[Registration]

1. Press the ARROW KEY BUTTON to call up the group that has stopped due to malfunction.

The unit No. the malfunction code is flashing because of an error failure.

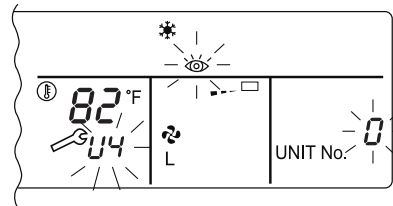

Operation lamp	Maintenance display	Unit No.	Malfunction code	Error content
☀	●	⚡	64	Indoor air thermistor error
☀	●	⚡	65	Outdoor air thermistor error
☀	●	⚡	68	HVU error (Ventiair dust-collecting unit)
☀	●	⚡	6A	Dumper system error
⚡	⚡	⚡	6A	Dumper system error + Thermistor error
☀	●	⚡	6F	Simple remote controller error
☀	●	⚡	6H	Door switch (Ventiair dust-collecting unit), relay harness fault (Ventiair dust-collecting/humidifier unit)
⚡	⚡	⚡	94	Ventiair internal transmission error (between total enthalpy – fan unit)
⚡	⚡	⚡	A0	Indoor unit · external safety device error
⚡	⚡	⚡	A1	Indoor unit · BEV unit (Sky-Air connection unit) PC board assembly fault
☀	●	⚡	A1	Indoor unit · PC board assembly fault
⚡	⚡	⚡	A3	Indoor unit · Drain level error (33H)
⚡	⚡	⚡	A6	Indoor unit · Fan motor (51F) lock, overload
☀	●	⚡	A7	Indoor unit · Fan direction adjustment motor (MA) error
⚡	⚡	⚡	A9	Indoor unit · BEV unit, electric expansion valve motor (20E) error
☀	●	⚡	AF	Indoor unit · Malfunctioning drain
☀	●	⚡	AH	Indoor unit · Dust-collector error
⚡	⚡	⚡	AJ	Indoor unit · Insufficient capacity setting, address setting fault

☼	☼	☼	C4	Indoor unit · Liquid piping thermistor (Th2) Error (faulty connection, cut wire, short circuit, fault)
☼	☼	☼	C5	Indoor unit · BEV unit, gas piping thermistor (Th3) Error (faulty connection, cut wire, short circuit, fault)
☼	☼	☼	C9	Indoor unit · Intake air thermistor (Th1) Error (faulty connection, cut wire, short circuit, fault)
☼	☼	☼	CA	Indoor unit · Outlet air thermistor (Th4) Error (faulty connection, cut wire, short circuit, fault)
☼	●	☼	CJ	Indoor unit · remote controller sensor error
☼	☼	☼	E0	Outdoor unit · Safety device operation
☼	☼	☼	E1	Outdoor unit · PC board assembly fault
☼	●	☼	E1	Outdoor unit · PC board assembly fault
☼	☼	☼	E3	Outdoor unit · High-pressure switch fault
☼	☼	☼	E4	Outdoor unit · Low-pressure switch fault
☼	☼	☼	E9	Outdoor unit · Electric expansion valve motor (20E) error
☼	●	☼	EC	Heat source unit · Intake water temperature inter-lock operation (fan operation)
☼	☼	☼	EF	Outdoor unit · Ice thermal storage unit error
☼	☼	☼	F3	Outdoor unit · Discharge piping temperature error
☼	●	☼	H3	Outdoor unit · High-pressure switch operation
☼	☼	☼	H4	Outdoor unit · Low-pressure switch operation
☼	☼	☼	H9	Outdoor unit · Outdoor air thermistor (Th1) Error (faulty connection, cut wire, short circuit, fault)
☼	●	☼	H9	Outdoor unit · Outdoor air thermistor (Th1) Error (faulty connection, cut wire, short circuit, fault)
☼	●	☼	HC	Outdoor unit · Water temperature sensor system error
☼	●	☼	HF	Ice thermal storage unit error, ice thermal storage controller error, error in outdoor unit during ice thermal storage operation
☼	☼	☼	HJ	Outdoor unit · water system fault
☼	☼	☼	J1	Outdoor unit · pressure sensor error
☼	☼	☼	J3	Outdoor unit · Discharge piping thermistor (Th3) Error (faulty connection, cut wire, short circuit, fault)
☼	●	☼	J3	Outdoor unit · Discharge piping thermistor (Th3) Error (faulty connection, cut wire, short circuit, fault)
☼	☼	☼	J5	Outdoor unit · Intake piping thermistor (Th4) Error (faulty connection, cut wire, short circuit, fault)
☼	☼	☼	J6	Outdoor unit · Heat exchange thermistor (Th2) error
☼	●	☼	J6	Outdoor unit · Heat exchange thermistor (Th2) error Error (faulty connection, cut wire, short circuit, fault)
☼	☼	☼	J7	Outdoor unit · Header thermistor (Th6) error
☼	☼	☼	JA	Outdoor unit · Discharge piping pressure sensor error
☼	☼	☼	JC	Outdoor unit · Intake piping pressure sensor error
☼	☼	☼	JF	Outdoor unit · Oil temperature sensor (Th5) system error
☼	●	☼	JH	Outdoor unit · Oil temperature sensor (Th5) system error
☼	☼	☼	L0	Outdoor unit · Inverter system fault
☼	☼	☼	L4	Outdoor unit · Inverter cooler fault
☼	☼	☼	L5	Outdoor unit · Ground circuit for compressor motor, short circuit, or power unit short circuit

☼	☼	☼	L6	Outdoor unit · Ground circuit for compressor motor, short circuit
☼	☼	☼	L8	Outdoor unit · Compressor overload, compressor motor wire disconnection
☼	☼	☼	L9	Outdoor unit · Compressor lock
☼	☼	☼	LA	Outdoor unit · Power unit error
☼	☼	☼	LC	Outdoor unit · Transmission error between inverter and outdoor control unit
☼ or ●	☼	☼	M1	Central controller: PC board fault
☼ or ●	☼	☼	M8	Transmission error between central controllers
☼ or ●	☼	☼	MA	Central controller: Incorrect combination
☼ or ●	☼	☼	MC	Central controller: Address setting fault
☼	●	☼	P0	Insufficient gas (thermal storage)
☼	☼	☼	P1	Outdoor unit · Power voltage imbalance, phase loss
☼	☼	☼	P4	Outdoor unit · Power unit temperature sensor error
☼	●	☼	U0	Pressure drop due to insufficient refrigerant, electric expansion valve fault, etc.
☼	☼	☼	U1	Reversed or lost phase
☼	☼	☼	U2	Power voltage error, momentary electrical stoppage
☼	☼	☼	U4	Transmission error between indoor unit/BEV unit and outdoor/BS unit, Transmission error between outdoor unit and BS unit
☼	☼	☼	U5	Transmission error between remote controller and indoor control unit
●	☼	●	U5	Remote controller board fault or remote controller setting fault
☼	☼	☼	U6	Transmission error between indoor units
☼	☼	☼	U7	Transmission error between outdoor units Transmission error between outdoor unit and ice thermal storage unit
☼	●	☼	U7	Transmission error between outdoor units (cooling/heating batch, low-noise operation)
☼	☼	●	U8	Transmission error between master remote controller and slave remote controller (slave remote controller error) Incorrect combination of indoor unit and remote controller within a single system (model)
☼	☼	☼	U9	Transmission error between indoor unit/BEV unit and outdoor unit within a single system Transmission error between BS unit and indoor unit/BEV unit and outdoor unit within a single system
☼	☼	☼	UA	Incorrect combination of indoor, BS, and outdoor units within a single system (model, number of units, etc.) Incorrect combination of indoor unit and remote controller (remote controller in question) BS unit connection position fault
☼	●	☼	UC	Central control group numbers overlap
☼	☼	☼	UE	Transmission error between indoor unit and central controller
☼	☼	☼	UF	Unset system, incorrect settings between BEV unit and indoor unit
☼	☼	☼	UH	System fault

■ error codes (in outline font) do not display “maintenance” and the system will run, but please check the content of the display and contact your dealer.

■ Setting master remote controller (Fig. 15)

You must set the master remote controller of the operation mode for one of the indoor units, if two or more such indoor units with the remote controller are connected with the outdoor unit where the operation modes such as cool/heat operation and FAN operation can be set by remote controller and central remote controller.

1. Preparations

When you want to fix settings

- Check the particular group with the master remote controller setting for the refrigerant system you wish to reset. (See the below.)
- Call up the group without the display “” (See page 16.)



➡ Hold the OPERATION MODE SELECTOR BUTTON down for about four seconds while the above group is being called up.

The display “” flashes on the liquid crystal display of the remote controller for all the groups sharing the same outdoor unit or BS unit.

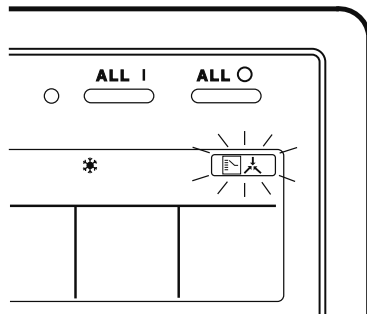
When you turn on the power switch for the first time, the display “” flashes.



2. Setting selection right

Pull up the desired group to set the master remote controller, and ➡ press the OPERATION MODE SELECTOR BUTTON. The master remote controller is set for this group, and the display “” goes out. The display “” appears for the other groups. Setting is finished now.



When switching operation

● In case of operation switch



Call up the zone including the group with the setting of master remote controller.

(Zone without the display “”)

➡ Press the OPERATION MODE SELECTOR BUTTON several times, and switch to the desired operation mode.

Each time you press it, the display is switched to “” “” “” and “--” in sequence.

NOTE

- However, the displays “” “” and “VENTILATION MODE” may appear in some zones, depending on the type on indoor unit with which they are connected.

(VENTILATION MODE)



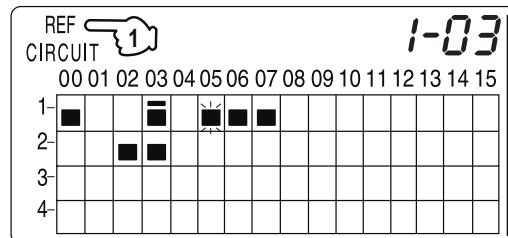

[System Display]

1. Test run mode is necessary to display the system display.
2. In order to turn on test run mode, select the appropriate air conditioner on the individual screen with the cursor and then set its operation mode to either cooling or heating. (It makes no difference if the air conditioner is running or not running while this operator is being performed.)
3. Press the “inspection/test run” button twice to put it into test run mode.
4. Pressing the “inspection/test run” button for four or more seconds in test run mode will display ➡ the “REF CIRCUIT.”



Call the unit whose system you wish to look up using the arrow keys.

The “” on all groups in the same system as the displayed group will light up.

Of those, the “” display in all groups which have cooling/heating selection privilege will blink.

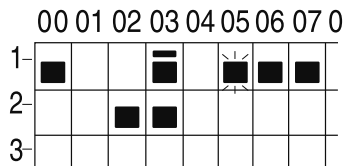

In this example, individual units 1-00, 1-03, 1-05, 1-06, 1-07, 2-02, and 2-03 are in the same system, and 1-05 has the cooling/heating selection privilege.

To look up other systems, call up all the units you wish to look up using the arrow keys.

Pressing the inspection/test run button one more time gets rid of the system display and ends it.

The unit will enter the individual screen automatically if nothing is done for one minute in the system display screen.



This function may not be available for all connected outdoor units, in which case “REF CIRCUIT” will blink. It will also not be correctly displayed if DIII-NET extension ADP is used.

■ Display of time to clean (Fig. 16)



This central remote controller displays the time to clean the air filter or air cleaner element for each group or any given group by utilizing two types of signs. The display “” tells the time to clean the air filter or the air cleaner element of some group.

If a cleaning sign is displayed

A filter or element in some group is ready to be cleaned.



1.  Press the **ARROW KEY BUTTON**, and search the groups displaying “” or “” (The group may be plural.)

Clean or change the air filter or air cleaner element.

For further details, see the operation manual attached to each indoor unit. (Clean or change the air filter or air cleaner element of all the groups displaying “” or “”.)

2.  Press the **FILTER SIGN RESET BUTTON**, and the display “” disappears. (Including all the groups where the air filter has been cleaned.)

NOTE

Be sure to check the display “” “” has disappeared at this point. The appearance of the above display is a sign that the air filter or air cleaner element of some group still needs cleaning.







INSTALLATION TABLE

When installing the equipment, mark the zone No. of each group and installation location in the below table.

Setting group No.

(Setting is not possible unless power is activated to both the central remote controller and indoor unit.)

Operated by remote controller

1. Activate power to both the central remote controller and indoor unit.
2. While in the normal mode, hold down the “” button for a minimum of 4 seconds. The unified ON/OFF controller will enter the FIELD SET MODE.
3. Select the MODE No. “” with the “” button.
4. Use the “” button to select the group No. for each group. (Group No. increases in the order of 1-00, 1-01 ... 1-15, 2-00, ... 8-15.)
5. Press “” to set the selected group No.
6. Press “” to return to the NORMAL MODE.

Operated by simplified remote controller

1. Activate power to both the central remote controller and indoor unit.
2. Remove the upper part of the remote controller.
3. Press the **BS6** BUTTON (field set) on the PC board. The controller will enter the FIELD SET MODE.
4. Select the MODE No. “” with the **BS2** BUTTON and **BS3** BUTTON (temperature setting).
5. Use the **BS9** BUTTON (set A) and **BS10** BUTTON (set B) to select the group No. for each group. (Group No. increases in the order of 1-00, 1-01 ... 1-15, 2-00, ... 8-15.)
6. Press **BS7** BUTTON (set/cancel) to set the selected group No.
7. Press **BS6** BUTTON (field set) to return to the NORMAL MODE.

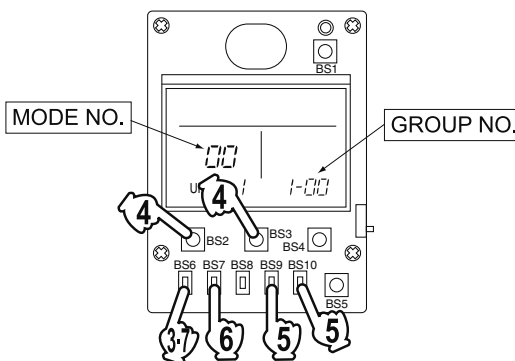
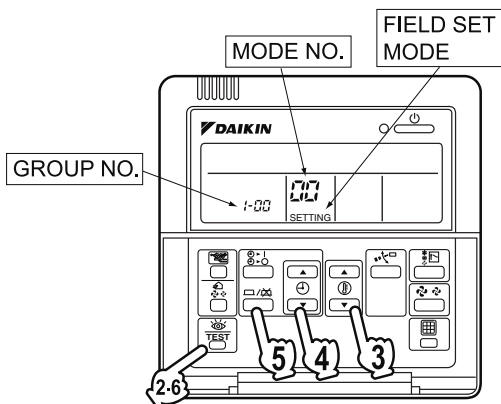

Zone No.																
Group No.	-00	-01	-02	-03	-04	-05	-06	-07	-08	-09	-10	-11	-12	-13	-14	-15
Indoor unit Quantity of units Controlled by																
Location																
Zone No.																
Group No.	-00	-01	-02	-03	-04	-05	-06	-07	-08	-09	-10	-11	-12	-13	-14	-15
Indoor unit Quantity of units Controlled by																
Location																

Zone No.																
Group No.	-00	-01	-02	-03	-04	-05	-06	-07	-08	-09	-10	-11	-12	-13	-14	-15
Indoor unit Quantity of units Controlled by																
Location																
Zone No.																
Group No.	-00	-01	-02	-03	-04	-05	-06	-07	-08	-09	-10	-11	-12	-13	-14	-15
Indoor unit Quantity of units Controlled by																
Location																

OPTIONAL ACCESSORIES

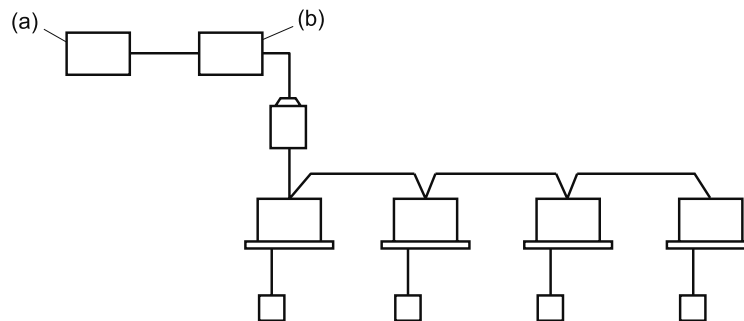

You can perform the normal operation, take off the malfunction contact point and unified start/stop by contact point, all by connecting this unit with the unification adaptor for computerized control. For further details, ask your DAIKIN dealer.

(a) Unification adaptor for computerized control (b) Central remote controller

DOUBLE CENTRAL REMOTE CONTROLLERS

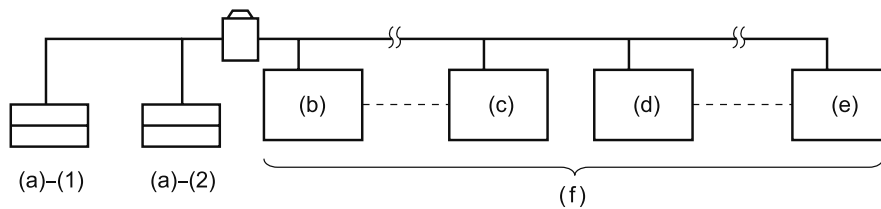

With two central remote controllers, centralized control (indoor units) is possible from different locations.

(a) Central remote controller (b) Group No. 1 - 00 (c) Group No. 1 - 15 (d) Group No. 2 - 00
 (e) Group No. 4 - 15 (f) A maximum of 64 groups

Note)

- For control alignment and settings for double central remote controllers, contact your dealer.

SPECIFICATIONS

■ Specifications

Power supply	1 ~ 50/60Hz, 100V - 240V
Power consumption	Max. 8W
Forced ON/OFF input	Continuous "a" contact Contact current: approximately 10mA
Size	180 (W) × 120 (H) × 64.5 (D)
Weight	420g

■ Outline drawings

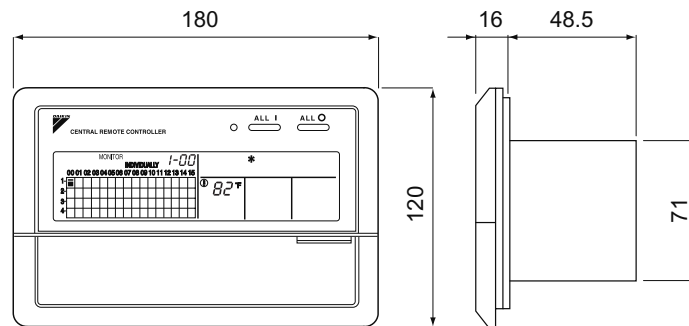

When using this unit an electric parts box of KJB311A is required.
For installation, a steel electric parts box to be embedded is mandatory.

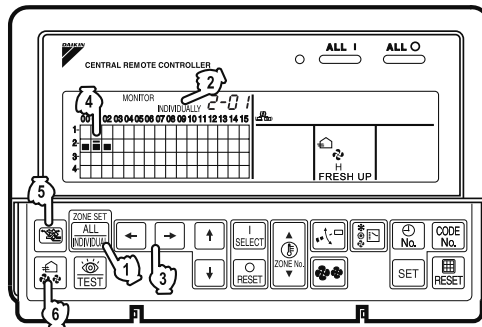

Fig. 9

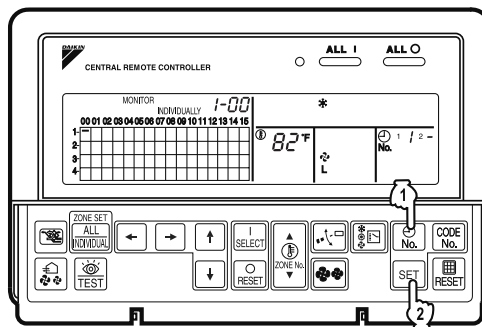

Fig. 10

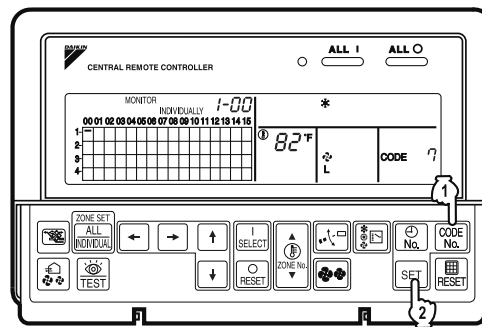

Fig. 11

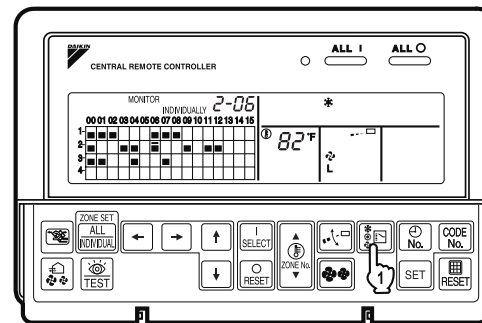

Fig. 12

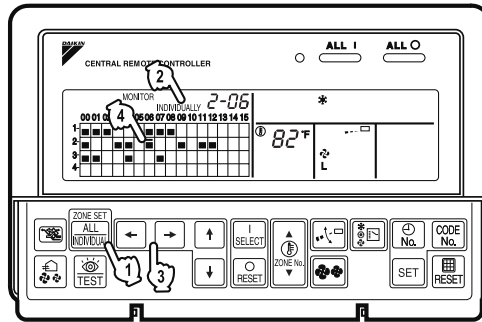

Fig. 13

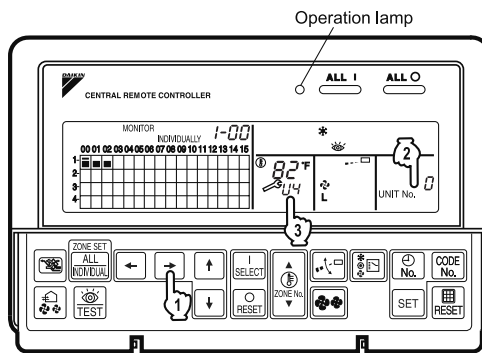

Fig. 14

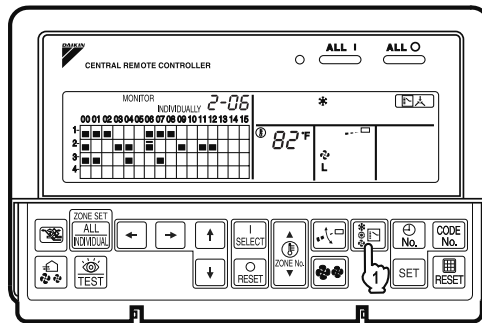

Fig. 15

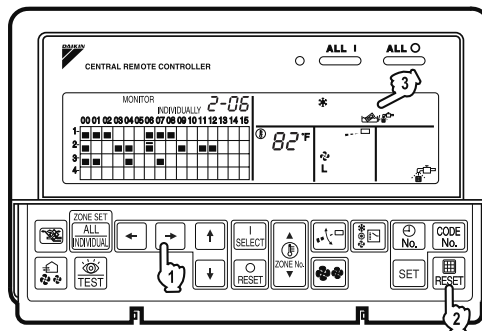





Fig. 16

2.7 <DCS301C71> Unified ON/OFF Controller (Installation)

Please read these "SAFETY CONSIDERATIONS" carefully before installing air conditioning equipment and be sure to install it correctly. After completing the installation, make sure that the unit operates properly during the start-up operation.
Please instruct the customer on how to operate the unit and keep it maintained.
Also, inform customers that they should store this installation manual along with the operation manual for future reference.
This air conditioner comes under the term "appliances not accessible to the general public".

Meaning of warning, caution and note symbols.

-  **WARNING**..... Indication a potentially hazardous situation which, if not avoided, could result in death or serious injury.
 **CAUTION**..... Indication a potentially hazardous situation which, if not avoided, may result in minor or moderate injury. It may also be used to alert against unsafe practices.
 **NOTE**..... Indication situation that may result in equipment or property-damage-only accidents.

WARNING

Ask your dealer or qualified personnel to carry out installation work. Do not try to install the machine by yourself.

Improper installation may result in water leakage, electric shocks or fire.

Perform installation work in accordance with this installation manual.

Improper installation may result in water leakage, electric shocks or fire.

Be sure to use only the specified accessories and parts for installation work.

Failure to use the specified parts may result in water leakage, electric shocks, fire or the unit falling.

Carry out the specified installation work after taking into account strong winds, typhoons or earthquakes.

Improper installation work may result in the equipment falling and causing accidents.

Make sure that a separate power supply circuit is provided for this unit and that all electrical work is carried out by qualified personnel according to local laws and regulations and this installation manual.

An insufficient power supply capacity or improper electrical construction may lead to electric shocks or fire.

Make sure that all wiring is secured, the specified wires are used, and no external forces act on the terminal connections or wires.

Improper connections or installation may result in fire.

When wiring the power supply and connecting the remote controller wiring and transmission wiring, position the wires so that the electric parts box lid can be securely fastened.

Improper positioning of the electric parts box lid may result in electric shocks, fire or the terminals overheating.

Before touching electrical parts, turn off the unit.

Ground the air conditioner. Do not connect the ground wire to gas or water pipes, lightning rod or a telephone ground wire.

Incomplete grounding may result in electric shocks.

When installing or relocating the system, be sure to keep the refrigerant circuit free from substances other than the specified refrigerant (R410A), such as air.

Do not reconstruct or change the settings of the protection devices.

If the pressure switch, thermal switch, or other protection device is shorted and operated forcibly, or parts other than those specified by Daikin are used, fire or explosion may result.

Do not touch the switch with wet fingers.

Touching a switch with wet fingers can cause electric shock.

Install a leak circuit breaker, as required.

If a leak circuit breaker is not installed, electric shock may result.

Do not install the air conditioner or the remote controller in the following locations:

- (a) where a mineral oil mist or an oil spray or vapor is produced, for example in a kitchen
Plastic parts may deteriorate and fall off or result in water leakage.
- (b) where corrosive gas, such as sulfuric acid gas, is produced
Corroding copper pipes or soldered parts may result in refrigerant leakage.
- (c) near machinery emitting electromagnetic waves
Electromagnetic waves may disturb the operation of the control system and result in a malfunction of the equipment.
- (d) where flammable gases may leak, where there are carbon fiber or ignitable dust suspensions in the air, or where volatile flammables such as thinner or gasoline are handled.
Operating the unit in such conditions may result in fire.

CAUTION

Be very careful about product transportation.

Safely dispose of the packing materials.

Packing materials, such as nails and other metal or wooden parts, may cause stabs or other injuries.
Tear apart and throw away plastic packaging bags so that children will not play with them. If children play with a plastic bag which was not torn apart, they face the risk of suffocation.

Do not turn off the power immediately after stopping operation.

Always wait at least five minutes before turning off the power. Otherwise, water leakage and trouble may occur.

NOTE

Install the indoor and outdoor units, power supply wiring and connecting wires at least 3.5ft. away from televisions or radios in order to prevent image interference or noise.

(Depending on the radio waves, a distance of 3.5ft. may not be sufficient enough to eliminate the noise.)

Remote controller (wireless kit) transmitting distance can result shorter than expected in rooms with electronic fluorescent lamps.

(inverter or rapid start types)
Install the indoor unit as far away from fluorescent lamps as possible.

This unit is a class A product.

In a domestic environment this product may cause radio interference in which case the user may be required to take adequate measures.

Dismantling of the unit, treatment of the refrigerant, oil and eventual other parts, should be done in accordance with the relevant local and national regulations.

1 COMPONENTS

Check the following components are included in this optional accessory before installation.

Body

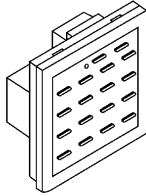

Installation screw (M4 x 16)	2
Operation manual	1
Installation manual	4
Installation table	4
Switch display sticker	1

When using this optional accessory an electric parts box of KJB212A is required. For installation, a steel electric parts box to be embedded is mandatory.

2 SYSTEM CONFIGURATION

This unified ON/OFF controller enables individual and unified operation/stop for a maximum of 16 groups of indoor units. With 2 to 8 unified ON/OFF controllers, individual and unified control is possible with up to a maximum 128 groups of indoor units.

- When using 1 unified ON/OFF controller

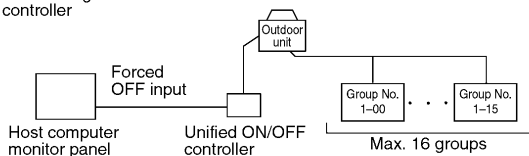

(This optional accessory can not be used in conjunction with wiring adapter for electrical appendices (optional accessory).)

- When using 2 to 8 unified ON/OFF controllers

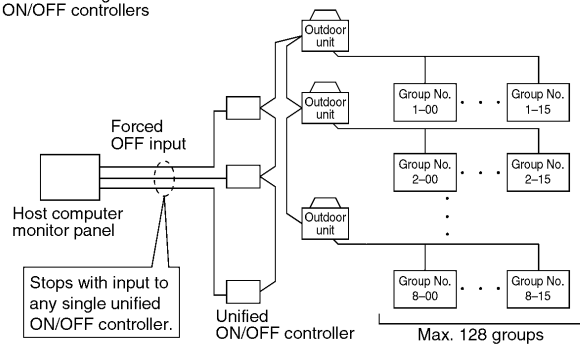

The groups of indoor units are as follows:

- 1 One indoor unit without remote controller

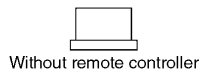

- 2 One indoor unit controlled by one or two remote controllers

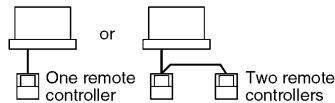

- 3 A maximum of 16 indoor units controlled in groups by one or two remote controllers

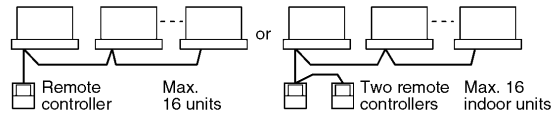

3 INSTALLATION

- 1 Open the upper part of remote controller. Insert a ⊖ screwdriver (2 locations) into the recess between the upper part and the lower part of remote controller and twist the screwdriver lightly.

PC board is attached with both the upper and lower part of remote controller. Do not damage the board with the screwdriver.

- 2 Open the upper part of remote controller and install the electric parts box (part to be procured in the field) with the attached installation screws (M4 x 16).

NOTE) Suitable length of the electric wire is about 160mm from the inlet of the electric parts box. If it is difficult to contain a long wiring, strip the sheathed part of the wiring.

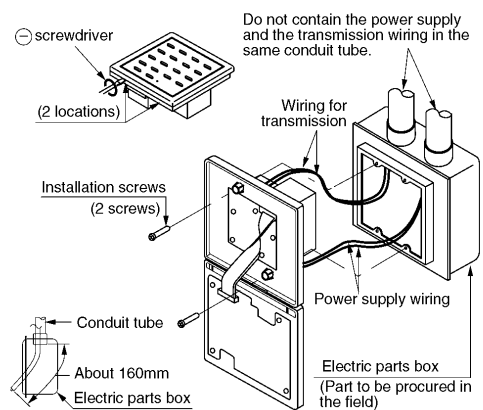

4 INITIAL SETTING

Setting ① through ③ are initialized when power is turned ON, therefore complete settings BEFORE activating the power.

- Connector for setting master controller (X1A) (Provided with connector at factory set)
 - When using 1 unified ON/OFF controller, do not disconnect the connector for setting master controller. (Use the unit with the connector in the state in which it was delivered.)
 - When using multiple unified ON/OFF controllers, or using the unified ON/OFF controller in conjunction with other optional controllers for centralized control, makes settings as indicated in the right table.

Pattern of connection of optional controllers for centralized control			Connector for setting master controller (X1A) Settings		
Unified ON/OFF controller	Central remote controller	Schedule timer	Unified ON/OFF controller	Central remote controller	Schedule timer
1 to 16	1 to 4		Set one to "Used" and all the rest to "Not used".		
		1	Set all to "Not used".	(Note)	
	1 to 4	1	Set one to "Used" and all the rest to "Not used".	(Note)	"Not used"

(Note) For instructions on how to set the connector for setting master controller on the central remote controller, see the installation manual provided with the central remote controller.

- Switch for setting each address (DS1)
These switches are used to set group control address.
Groups Nos. 1-00 through 1-15 are grouped in the same control group when the unit is shipped from the factory.

Each Address	1-00 ~ 1-15	2-00 ~ 2-15	3-00 ~ 3-15	4-00 ~ 4-15	5-00 ~ 5-15	6-00 ~ 6-15	7-00 ~ 7-15	8-00 ~ 8-15
DS1 setting								

NOTE) ■ indicates the position of switches.

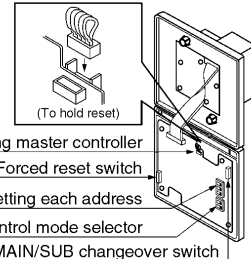

After setting, attach the number seal applicable to respective control range of the attached switch display sticker, as shown in the diagram below.

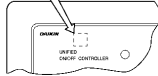

(Example)
In the case of 1-00 to 1-15, attach 1.

- MAIN/SUB changeover switch setting
With two unified ON/OFF controllers, centralized control (indoor units) is possible from different locations. In this kind of set-up, it is necessary to set the MAIN/SUB changeover switch. One of the two unified ON/OFF controllers (1)-(2) is set to "MAIN" while the other is set to "SUB".
- Setting of the sequential operation function
The unified ON/OFF controller is equipped with a sequential operation function that sequentially turns indoor units on in 2-second intervals during unified operation. (Sequential operation is factory set to "ON.")
To switch sequential operation ON or OFF, set as follows.

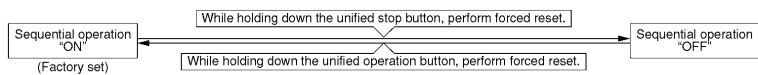

NOTE: The sequential operation function is designed to reduce the load on the power supply equipment, but does not guarantee that compressors will not be started simultaneously. You cannot therefore count on a capacity reduction effect by power supply equipment breaker selection.

- Control mode selector (DS2)
The following four patterns of control mode can be set.

Control mode	Individual	Centralized	Timer operation possible by remote controller	ON/OFF control impossible by remote controller
Content	Operation/stop is controlled by both unified ON/OFF controller and remote controller.	After operated by unified ON/OFF controller, operation/stop is freely controlled by remote controller until stopped by unified ON/OFF controller.	When used in conjunction with schedule timer, operation/stop is controlled freely by remote controller during the set time but operation is not available when schedule timer is ON.	Operation/stop is controlled by unified ON/OFF controller only. (This unit can not be operated/stopped by remote controller.)
DS2 setting	(Factory set)			

- NOTES)
- indicates the position of switches.
 - Set control mode before turning power supply ON.
 - When used in conjunction with central remote controller, the control modes of the central remote controller has the priority.

- Forced reset switch (SS1)
When changing the setting of the connector for setting master controller, etc., you can reset simply by setting it to the reset side once and returning to the normal side, without turning the power OFF.
(For normal operation, set the switch to the normal side.)

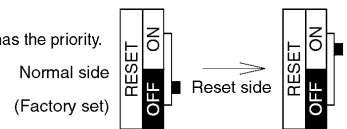

5 ELECTRIC WIRING

GENERAL INSTRUCTIONS

- All wiring, components and materials to be procured on the site must comply with the applicable local and national codes.
- Use copper conductors only.
- All field wiring and components must be provided by licensed electrician.
- Unit shall be grounded in compliance with the applicable local and national codes.
- Fit the power supply wiring with a fuse and a switch.
- After wiring work, check power to the equipment shuts OFF when switch is shut OFF.

WIRING OUTLINE

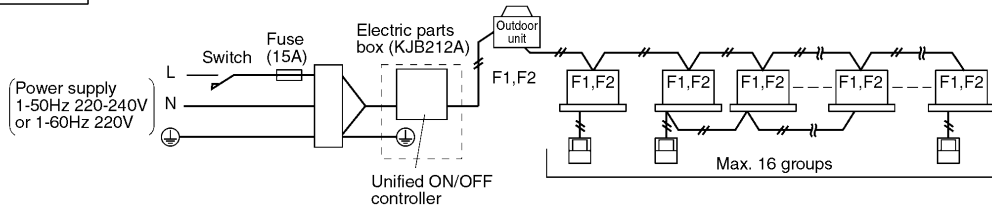

Wiring specification

	Type	Size
Power supply wiring	H05VV-U3G	(NOTE 1)
Transmission wiring	Sheathed wire (2 wire) (NOTE 2)	0.75 - 1.25mm ²

- NOTES) 1. The size of power supply wiring must comply with the applicable national and local codes.
 2. Allowable length of transmission wiring is as follows.
 Max. 1000m (Total wiring length: 2000m)

Connect the wiring between indoor and outdoor units, indoor/outdoor units and power supply, and indoor units and remote controllers. For details, refer to the installation manuals of indoor and outdoor units.

WIRING TO THE INDOOR UNIT AND OUTDOOR UNIT

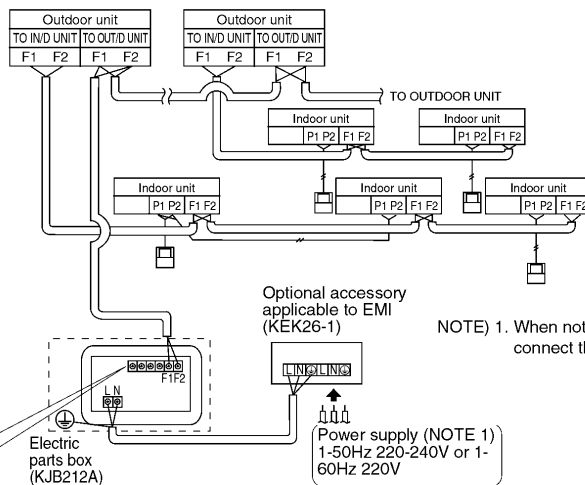

NOTE) 1. When not using the optional accessory applicable to EMI (KEK26-1), connect the power supply wiring directly to the unified ON/OFF controller.

CONTROL TERMINAL STRIP

- *1 For connecting indoor unit (F1, F2)
- *2 Forced OFF input (T1, T2)

While the forced OFF input (no voltage contactor, for micro current) is ON (energized), all the connected indoor units are stopped and can not be operated. Use only contactors which guarantee the minimum applicable load ≧ 16V, 10mA.

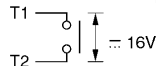

NOTE) Use instantaneous contactor of over 200msec. energizing time, when necessary.

- *3 For schedule timer (D1, D2)

Power can be supplied to the schedule timer (DST301B51*61 optional accessory). For details, refer to the installation manual of the schedule timer. Wire *2 and *3 only when necessary.

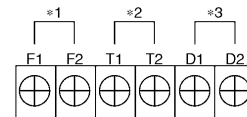







(NOTE)

Do not connect the power supply wiring (220 to 240V) to the control terminal strip. If connected by mistake, it may damage or burn electrical parts of optional controllers for centralized control and indoor unit. It may result in serious danger. Be sure to check wirings before turning the power ON.

6 SETTING GROUP NO. FOR CENTRALIZED CONTROL

Set the group number of each group of the indoor unit from the remote controller. (In case of no remote controller, also connect the remote controller and set the group No. Then, remove the remote controller.)

- 1 Turn ON the power of the indoor unit and unified ON/OFF controller. (Unless the power is ON, no setting can be made.)
Check that the installation and electrical wiring are correct before turning the power supply ON.
When the power supply is turned ON, all LCD appear once and the unit may not accept the operation for about one minute with the display of "  " flashing (an interval of ON, ON, and OFF).
- 2 While in the normal mode, hold down the "  " button for a minimum of 4 seconds.
The remote controller will enter the FIELD SET MODE.
- 3 Select the MODE No. "  " with the "  " button.
- 4 Use the "  " button to select the group No. for each group.
(Group numbers increase in the order of 1-00, 1-01, ... 1-15, 2-00, ... 8-15.)
- 5 Press "  " to set the selected group No.
- 6 Press "  " to return to the NORMAL MODE.

- NOTES)
- For simplified remote controller, see the installation table.
 - For setting group No. of HRV and wiring adaptor for other air conditioners, etc., refer to the instruction manual attached.

NOTICE Enter the group No. and installation place of the indoor unit into the attached installation table.
Be sure to keep the installation table with the operation manual for maintenance.

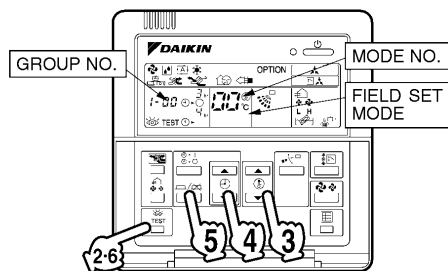

7 CONFIRMING OPERATION

Before starting test operation, supply power to the indoor units, outdoor units, and unified ON/OFF controller and press the ON/OFF BUTTON.

If the operation lamp flashes, it indicates a malfunction in the indoor unit of the applicable group.



If the display of "  " flashes, it indicates a malfunction in the optional controllers for centralized control. Check for such malfunctions.

- NOTES**
- For test operation of indoor and outdoor units, refer to the installation manual attached with the outdoor unit.
 - After turning the power supply ON, if the unit does not accept operation for two minutes or more with the display of "  " flashing, check the following points.
 - Check that setting of the connector for setting master controller is correct.
 - Check that the group No. for centralized control has been set.

2.8 <DCS301C71> Unified ON/OFF Controller (Operation)

Please read these "SAFETY CONSIDERATIONS" carefully before installing air conditioning equipment and be sure to install it correctly. After completing the installation, make sure that the unit operates properly during the start-up operation.
Please instruct the customer on how to operate the unit and keep it maintained.
Also, inform customers that they should store this installation manual along with the operation manual for future reference.
This air conditioner comes under the term "appliances not accessible to the general public"

Meaning of warning, caution and note symbols.

-  **WARNING** Indication a potentially hazardous situation which, if not avoided, could result in death or serious injury.
-  **CAUTION** Indication a potentially hazardous situation which, if not avoided, may result in minor or moderate injury. It may also be used to alert against unsafe practices.
-  **NOTE** Indication situation that may result in equipment or property-damage-only accidents.

Keep these warning sheets handy so that you can refer to them if needed.

Also, if this equipment is transferred to a new user, make sure to hand over this operation manual to the new user.

WARNING

In order to avoid electric shock, fire or injury, or if you detect any abnormality such as smell of fire, turn off power and call your dealer for instructions.

Ask your dealer for installation of the air conditioner.

Incomplete installation performed by yourself may result in a water leakage, electric shock, and fire.

Ask your dealer for improvement, repair, and maintenance.

Incomplete improvement, repair, and maintenance may result in a water leakage, electric shock, and fire.

Improper installation or attachment of equipment or accessories could result in electric shock, short-circuit, leaks, fire or other damage to the equipment. Be sure only to use accessories made by Daikin which are specifically designed for use with the equipment and have them installed by a professional.

Ask your dealer to move and reinstall the air conditioner or the remote controller.

Incomplete installation may result in a water leakage, electric shock, and fire.

Never let the indoor unit or the remote controller get wet.

It may cause an electric shock or a fire.

Never use flammable spray such as hair spray, lacquer or paint near the unit.

It may cause a fire.

Never replace a fuse with that of wrong ampere ratings or other wires when a fuse blows out.

Use of wire or copper wire may cause the unit to break down or cause a fire.

Never inspect or service the unit by yourself.

Ask a qualified service person to perform this work.

Cut off all electric waves before maintenance.

Do not wash the air conditioner or the remote controller with excessive water.

Electric shock or fire may result.

Do not install the air conditioner or the remote controller at any place where flammable gas may leak out.

If the gas leaks out and stays around the air conditioner, a fire may break out.

Do not touch the switch with wet fingers.

Touching a switch with wet fingers can cause electric shock.

CAUTION

After a long use, check the unit stand and fitting for damage.

If they are left in a damaged condition, the unit may fall and result in injury.

Do not allow a child to mount on the unit or avoid placing any object on it.

Falling or tumbling may result in injury.

Do not let children play on and around the unit.

If they touch the unit carelessly, it may result in injury.

Do not place a flower vase and anything containing water.

Water may enter the unit, causing an electric shock or fire.

Never touch the internal parts of the controller.

Do not remove the front panel. Some parts inside are dangerous to touch, and a machine trouble may happen.

For checking and adjusting the internal parts, contact your dealer.

Avoid placing the controller in a spot splashed with water.

Water coming inside the machine may cause an electric leak or may damage the internal electronic parts.

Do not operate the air conditioner when using a room fumigation - type insecticide.

Failure to observe could cause the chemicals to become deposited in the unit, which could endanger the health of those who are hypersensitive to chemicals.

Safely dispose of the packing materials.

Packing materials, such as nails and other metal or wooden parts, may cause stabs or other injuries.

Tear apart and throw away plastic packaging bags so that children will not play with them. If children play with a plastic bag which was not torn apart, they face the risk of suffocation.

Do not turn off the power immediately after stopping operation.

Always wait at least five minutes before turning off the power. Otherwise, water leakage and trouble may occur.

The appliance is not intended for use by young children or infirm persons without supervision.

The remote controller should be installed in such away that children cannot play with it.

NOTE

Never press the button of the remote controller with a hard, pointed object.

The remote controller may be damaged.

Never pull or twist the electric wire of the remote controller.

It may cause the unit to malfunction.

Do not place the controller exposed to direct sunlight.

The LCD display may get discolored, failing to display the data.

Do not wipe the controller operation panel with benzine, thinner, chemical dustcloth, etc.

The panel may get discolored or the coating peeled off. If it is heavily dirty, soak a cloth in water-diluted neutral detergent, squeeze it well and wipe the panel clean. And wipe it with another dry cloth.

Dismantling of the unit, treatment of the refrigerant, oil and eventual other parts, should be done in accordance with the relevant local and national regulations.

1 NAMES AND FUNCTIONS

“UNDER HOST COMPUTER INTEGRATED CONTROL” LAMP
When this lamp turns on, no other operations are possible.

GROUP NO.

ROOM NAME INDICATION PLATE
Refer to the “2. PUTTING ROOM NAME INDICATION STICKER”

UNIFIED OPERATION/STOP BUTTON
Starts/stops all indoor units.

OPERATION LAMP
Turns on during operation of each group and flashes during malfunction stop.

INDIVIDUAL OPERATION/STOP BUTTON
Starts/stops each indoor unit group individually.

«NOTE»

- When using unified ON/OFF controller with other optional controllers for centralized control, “OPERATION LAMP” of the equipment which is not operated may turn on or off after several minutes. This state occurs due to signal communications and is not a failure.
- Do not open the upper part of remote controller except when rewriting the indication sticker or selecting control modes.

2 PUTTING ROOM NAME INDICATION STICKER

- Open the upper part of remote controller. Insert a (-) screwdriver into the recess between the upper and lower part of remote controller (at 2 locations) and twist the screwdriver lightly.

PC board is attached both the upper and lower part of remote controller. Do not damage the board with the screwdriver.
- Pull out the room name indication plate. Insert the point of a mechanical pencil etc. into the hole of the indication sticker to pull it out.
- Put the attached indication sticker on the room name indication plate.

In case of serial type indication sticker: Put the sticker aligning the lines of the sticker with those of the plate.

In case of individual type indication sticker: Write the room name in the frame of the sticker with a ball point pen or a felt-tip pen (oil-base).
- Reinstall the plate as it were, with checking the correct direction.
- Close the upper part of remote controller.

3 SELECTING CONTROL MODES

The following four patterns of control mode can be set.

Control mode	Individual	Centralized	Timer operation possible by remote controller	ON/OFF control impossible by remote controller
Content	Operation/stop is controlled by both unified ON/OFF controller and remote controller.	After operated by unified ON/OFF controller, operation/stop is freely controlled by remote controller until stopped by unified ON/OFF controller.	When used in conjunction with schedule timer, operation/stop is controlled freely by remote controller during the set time but operation is not available when schedule timer is ON.	Operation/stop is controlled by unified ON/OFF controller only. Indoor units can not be operated/stopped by remote controller.
DS2 setting				

NOTE:

- indicates the position of switches.
- Set control modes before turning power supply on.
- When used in conjunction with central remote controller, the control modes of the central remote controller has the priority.

4 DISPLAY OF MALFUNCTION

Flashing of lamps indicates malfunctions. Contact your Daikin dealer. When turning power supply on, all lamps may light and UNDER HOST COMPUTER INTEGRATED CONTROL lamp may flash and not accept the operation for about on minute. These conditions are not malfunctions.

States of lamps	Contents of malfunctions
Flashing of operation lamp	Indicates malfunctions in the indoor unit in the group where the operation lamp is flashing.
Flashing of UNDER HOST COMPUTER INTEGRATED CONTROL lamp	Indicates malfunctions in optional controllers for centralized control.

2.9 <DST301BA61> Schedule Timer Controller (Installation)

Please read these "SAFETY CONSIDERATIONS" carefully before installing air conditioning equipment and be sure to install it correctly. After completing the installation, make sure that the unit operates properly during the start-up operation. Please instruct the customer on how to operate the unit and keep it maintained. Also, inform customers that they should store this installation manual along with the operation manual for future reference. This air conditioner comes under the term "appliances not accessible to the general public".

Meaning of warning, caution and note symbols.

- ⚠ **WARNING** Indication a potentially hazardous situation which, if not avoided, could result in death or serious injury.
- ⚠ **CAUTION** Indication a potentially hazardous situation which, if not avoided, may result in minor or moderate injury. It may also be used to alert against unsafe practices.
- ⚠ **NOTE** Indication situation that may result in equipment or property-damage-only accidents.

⚠ **WARNING**

Ask your dealer or qualified personnel to carry out installation work. Do not try to install the machine by yourself.
Improper installation may result in water leakage, electric shocks or fire.

Perform installation work in accordance with this installation manual.
Improper installation may result in water leakage, electric shocks or fire.

Be sure to use only the specified accessories and parts for installation work.
Failure to use the specified parts may result in water leakage, electric shocks, fire or the unit falling.

Carry out the specified installation work after taking into account strong winds, typhoons or earthquakes.
Improper installation work may result in the equipment falling and causing accidents.

Make sure that a separate power supply circuit is provided for this unit and that all electrical work is carried out by qualified personnel according to local laws and regulations and this installation manual.
An insufficient power supply capacity or improper electrical construction may lead to electric shocks or fire.

Make sure that all wiring is secured, the specified wires are used, and no external forces act on the terminal connections or wires.
Improper connections or installation may result in fire.

When wiring the power supply and connecting the remote controller wiring and transmission wiring, position the wires so that the electric parts box lid can be securely fastened.
Improper positioning of the electric parts box lid may result in electric shocks, fire or the terminals overheating.

Before touching electrical parts, turn off the unit.

Ground the air conditioner. Do not connect the ground wire to gas or water pipes, lightning rod or a telephone ground wire.
Incomplete grounding may result in electric shocks.

When installing or relocating the system, be sure to keep the refrigerant circuit free from substances other than the specified refrigerant (R410A), such as air.

Do not reconstruct or change the settings of the protection devices.
If the pressure switch, thermal switch, or other protection device is shorted and operated forcibly, or parts other than those specified by Daikin are used, fire or explosion may result.

Do not touch the switch with wet fingers.
Touching a switch with wet fingers can cause electric shock.

Install an earth leak circuit breaker, as required.
If an earth leak circuit breaker is not installed, electric shock may result.

Do not install the air conditioner or the remote controller in the following locations:

- (a) where a mineral oil mist or an oil spray or vapor is produced, for example in a kitchen
Plastic parts may deteriorate and fall off or result in water leakage.
- (b) where corrosive gas, such as sulfurous acid gas, is produced
Corroding copper pipes or soldered parts may result in refrigerant leakage.
- (c) near machinery emitting electromagnetic waves
Electromagnetic waves may disturb the operation of the control system and result in a malfunction of the equipment.
- (d) where flammable gases may leak, where there are carbon fiber or ignitable dust suspensions in the air, or where volatile flammables such as thinner or gasoline are handled.
Operating the unit in such conditions may result in fire.

CISPR 22 Class A Warning.

This is a class A product. In a domestic environment this product may cause radio interference in which case the user may be required to take adequate measures.

⚠ CAUTION

Be very careful about product transportation.

Safely dispose of the packing materials.

Packing materials, such as nails and other metal or wooden parts, may cause stabs or other injuries. Tear apart and throw away plastic packaging bags so that children will not play with them. If children play with a plastic bag which was not torn apart, they face the risk of suffocation.

Do not turn off the power immediately after stopping operation.

Always wait at least five minutes before turning off the power. Otherwise, water leakage and trouble may occur.

⚠ NOTE

Install the indoor and outdoor units, power supply wiring and connecting wires at least 3.5ft. away from televisions or radios in order to prevent image interference or noise.

(Depending on the radio waves, a distance of 3.5ft. may not be sufficient enough to eliminate the noise.)

Remote controller (wireless kit) transmitting distance can result shorter than expected in rooms with electronic fluorescent lamps. (inverter or rapid start types)

Install the indoor unit as far away from fluorescent lamps as possible.

This unit is a class A product.

In a domestic environment this product may cause radio interference in which case the user may be required to take adequate measures.

Dismantling of the unit, treatment of the refrigerant, oil and eventual other parts, should be done in accordance with the relevant local and national regulations.

1 ACCESSORIES

Check the following accessories are included in the kit before installation.

Body	1	Installation screws (M4 × 16)	2
Operation manual	1	Attached electric wire (for individual use)	1
Installation manual*	4	Crimp style terminal (for individual use)	2

For Installation, a electrical box to be embedded is necessary (part to be procured in the field/with covers).

* DST301BA61 includes only one installation manual.

2 INSTALLATION AND INITIAL SETTING

1. Remove the upper part of the remote controller.

- Insert a (-) screwdriver (2 locations) into the recess between the upper part and the lower part of the remote controller and twist the screwdriver lightly.

(The PC board is attached with the upper part of the remote controller. Do not damage electric parts with a screwdriver, etc.)

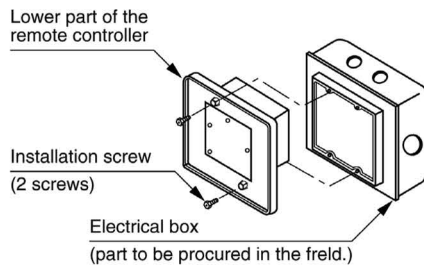
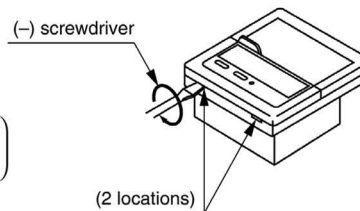

- Attach the lower part to the electrical box (part to be procured in the field) with the provided installation screws.

(Select a flat face as a installation place. Do not tighten the installation screws excessively not to damage the lower part of the remote controller.)

For part to be procured in the field electrical box, use KJB212AA (optional accessory).

2. Initial setting

① Setting connector for individual use (X1A) (Factory set : OFF) (Set for individual use only)

- For individual use of schedule timer
Insert the connector attached with the body case on the PC board.
- For combined use with other optional controllers for centralized control
Do not change the factory setting.

② Control mode selector (SS2) (Set for individual use only)

By changing the switch, setting mode of individual and centralized operation is available.

Note) When used with other optional controllers, control mode of central remote controller and unified ON/OFF controller have the priority.

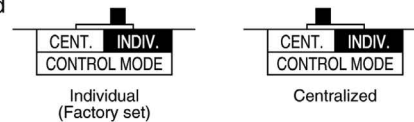

③ Setting of the sequential operation function

The schedule timer is equipped with a sequential operation function that sequentially turns indoor units on in 2-second intervals during unified operation.

(Sequential operation is factory set to "ON.")

To switch sequential operation ON or OFF, set as follows.

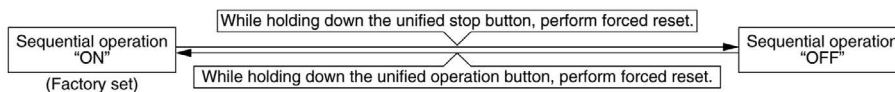

Note) The sequential operation function is designed to reduce the load on the power supply equipment, but does not guarantee that compressors will not be started simultaneously. You cannot therefore count on a capacity reduction effect by power supply equipment breaker selection.

④ Forced reset switch (SS1)

When changing the setting of the connector for individual use, etc., the switch can be reset simply by setting it to the reset side once and returning to the normal side. This procedure enables to reset without turning off the power. (Set the normal side at normal operation.)

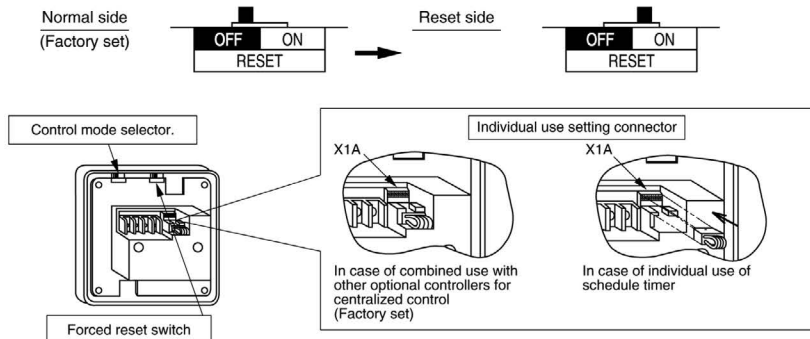

⑤ Setting for special function

When you want to have a programmed operation of a part of indoor units by using only schedule timer, cut off JP1 and supply the power again. You can have a programmed operation of the indoor units set the address for central control by local remote controller.

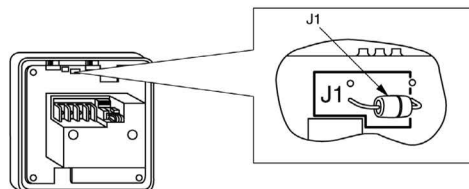

3. Transmission wiring

- In case of individual use of schedule timer
Connect terminals of the schedule timer (F1, F2) with terminals of the indoor unit (F1, F2). Connect terminals of the schedule timer (D1, D2) and the connector on the indoor unit PC board, using the attached electric wire and crimp style terminals. Prevent the connection part of crimp style terminal from getting out of the electric parts box of indoor unit.
- In case of combined use with other optional controllers for centralized control
Connect terminals of the schedule timer (F1, F2, D1, D2) and the terminals of the central remote controller (or unified ON/OFF controller).

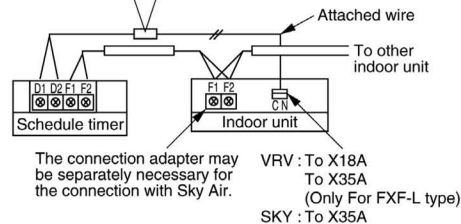
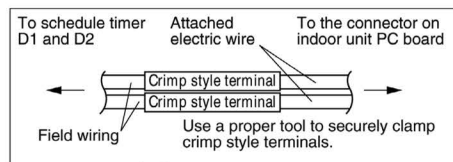

Wiring specifications

	F1, F2	D1, D2
Wiring	Sheathed wire (2-wire)	Sheathed wire (2-wire)
Gauge	0.75 ~ 1.25mm ²	0.75 ~ 1.25mm ²
Length	Max. 1000m	Max. 150m

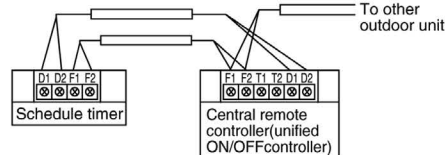

NOTES:

- Electrical box and transmission wiring are not attached.
- Do not touch the PC board with your hand.
- Keep transmission wiring at least 50 mm away from power supply wiring to avoid malfunctions.

4. Install the upper part of the remote controller as before.

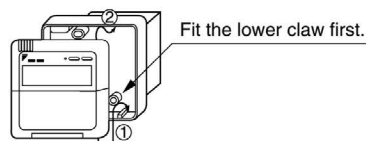

3 SETTING GROUP NO. FOR CENTRALIZED CONTROL

Set the group number of each group of the indoor unit from the remote controller. (In case of no remote controller, also connect the remote controller and set the group No. Then, remove the remote controller.)

- (1) Turn ON the power of the indoor unit and SCHEDULE TIMER.
(Unless the power is ON, no setting can be made.)
Check that the installation and electrical wiring are correct before turning the power supply ON.
(When the power supply is turned ON, all LCD appear once and the unit may not accept the operation for about one minute with the display of "88".)

- (2) While in the normal mode, hold down the "TEST" button for a minimum of 4 seconds.
The remote controller will enter the FIELD SET MODE.

- (3) Select the MODE No. "00" with the "MODE" button.

- (4) Use the "GROUP NO." button to select the group No. for each group.

(Group numbers increase in the order of
1-00,1-01,...1-15, 2-00,...8-15.)

- (5) Press "OK" to set the selected group No.

- (6) Press "EXIT" to return to the NORMAL MODE.

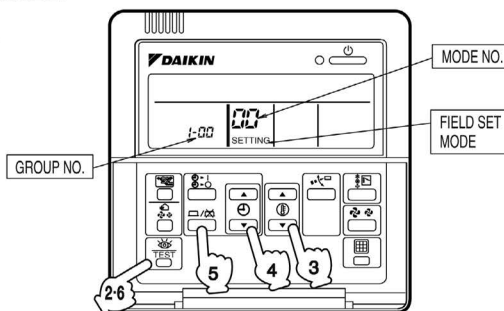

- NOTES)
- In case of individual use of schedule timer
Group number setting is not necessary. It is automatically set when turning power supply ON.
 - See the instruction manuals which came with the VentiAir and adapters (i.e., multi-purpose adapters) for details on their Group No. settings.

NOTICE Be sure to keep the operation manual for maintenance.

4 TEST OPERATION

Refer to the installation manual attached to the outdoor unit.

In case the schedule timer is used individually and the wiring is changed after the system has been operated, reset the power after energizing for more than five minutes.
It may not be possible to control the unit from the schedule timer.

2.10 <DST301BA61> Schedule Timer Controller (Operation)

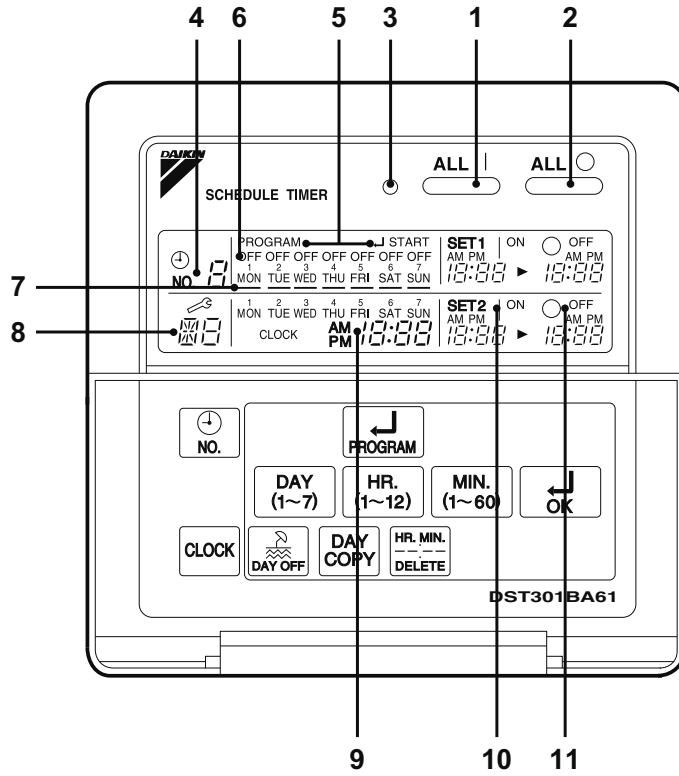

1

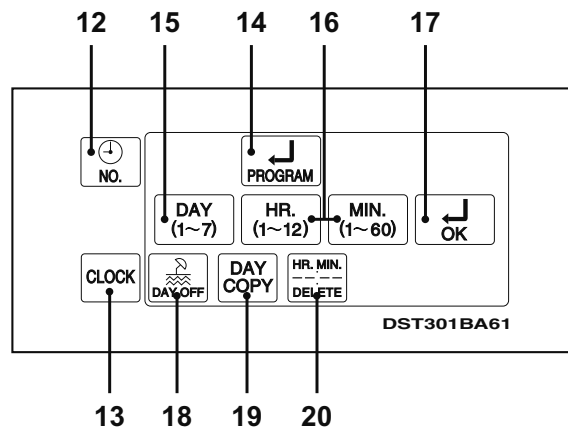

2

[1]

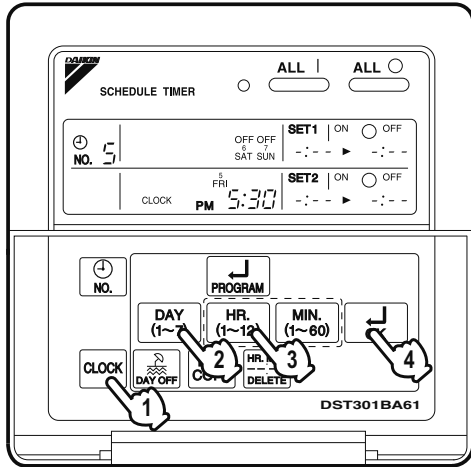

3

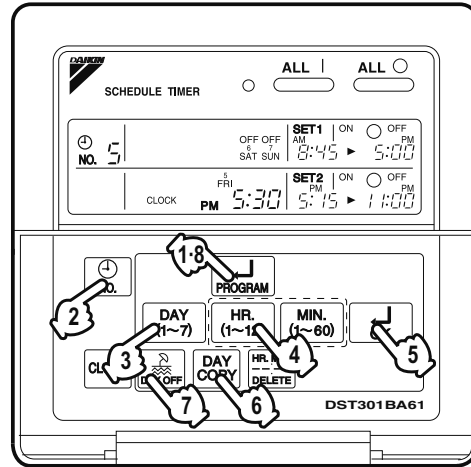

4

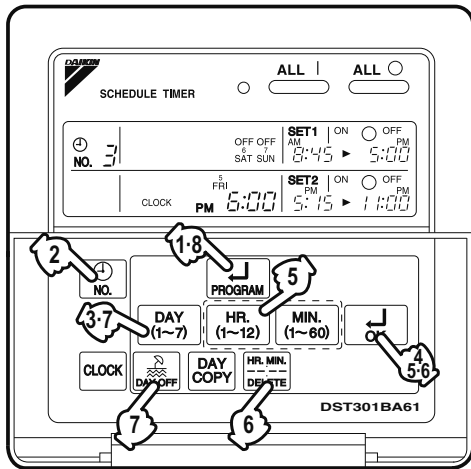

5

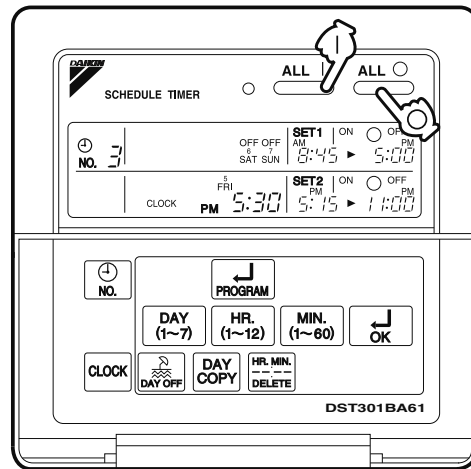

6

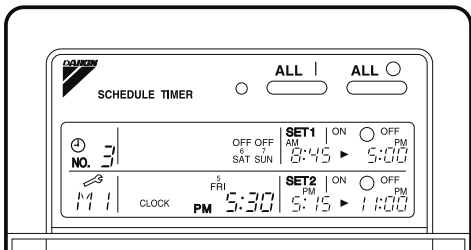

7

[2]

SAFETY CONSIDERATIONS

Please read these " SAFETY CONSIDERATIONS " carefully before installing air conditioning equipment and be sure to install it correctly. After completing the installation, make sure that the unit operates properly during the start-up operation.

Please instruct the customer on how to operate the unit and keep it maintained.

Also, inform customers that they should store this installation manual along with the operation manual for future reference.

This air conditioner comes under the term " appliances not accessible to the general public ".

Meaning of warning, caution and note symbols.

 **WARNING** Indicates a potentially hazardous situation which, if not avoided, could result in death or serious injury.

 **CAUTION** Indicates a potentially hazardous situation which, if not avoided, may result in minor or moderate injury. It may also be used to alert against unsafe practices.

 **NOTE** Indicates situation that may result in equipment or property-damage-only accidents.

Keep these warning sheets handy so that you can refer to them if needed.

Also, if this equipment is transferred to a new user, make sure to hand over this operation manual to the new user.

WARNING

In order to avoid electric shock, fire or injury, or if you detect any abnormality such as smell of fire, turn off power and call your dealer for instructions.

Ask your dealer for installation of the air conditioner.

Incomplete installation performed by yourself may result in a water leakage, electric shock, and fire.

Ask your dealer for improvement, repair, and maintenance.

Incomplete improvement, repair, and maintenance may result in a water leakage, electric shock, and fire.

Improper installation or attachment of equipment or accessories could result in electric shock, short-circuit, leaks, fire or other damage to the equipment. Be sure only to use accessories made by Daikin which are specifically designed for use with the equipment and have them installed by a professional.

Ask your dealer to move and reinstall the air conditioner or the remote controller.

Incomplete installation may result in a water leakage, electric shock, and fire.

Never let the indoor unit or the remote controller get wet.

It may cause an electric shock or a fire.

Never use flammable spray such as hair spray, lacquer or paint near the unit.

It may cause a fire.

Never replace a fuse with that of wrong ampere ratings or other wires when a fuse blows out.

Use of wire or copper wire may cause the unit to break down or cause a fire.

Never inspect or service the unit by yourself.

Ask a qualified service person to perform this work.

Cut off all electric waves before maintenance.

Do not wash the air conditioner or the remote controller with excessive water. Electric shock or fire may result.

Do not install the air conditioner or the remote controller at any place where flammable gas may leak out.

If the gas leaks out and stays around the air conditioner, a fire may break out.

Do not touch the switch with wet fingers.

Touching a switch with wet fingers can cause electric shock.

CISPR 22 Class A Warning:

This is a class A product. In a domestic environment this product may cause radio interference in which case the user may be required to take adequate measures.

— CAUTION —

After a long use, check the unit stand and fitting for damage.

If they are left in a damaged condition, the unit may fall and result in injury.

Do not allow a child to mount on the unit or avoid placing any object on it.

Falling or tumbling may result in injury.

Do not let children play on and around the unit.

If they touch the unit carelessly, it may result in injury.

Do not place a flower vase and anything containing water.

Water may enter the unit, causing an electric shock or fire.

Never touch the internal parts of the controller.

Do not remove the front panel. Some parts inside are dangerous to touch, and a machine trouble may happen.

For checking and adjusting the internal parts, contact your dealer.

Avoid placing the controller in a spot splashed with water.

Water coming inside the machine may cause an electric leak or may damage the internal electronic parts.

Do not operate the air conditioner when using a room fumigation - type insecticide.

Failure to observe could cause the chemicals to become deposited in the unit, which could endanger the health of those who are hypersensitive to chemicals.

Safely dispose of the packing materials.

Packing materials, such as nails and other metal or wooden parts, may cause stabs or other injuries.

Tear apart and throw away plastic packaging bags so that children will not play with them. If children play with a plastic bag which was not torn apart, they face the risk of suffocation.

Do not turn off the power immediately after stopping operation.

Always wait at least five minutes before turning off the power. Otherwise, water leakage and trouble may occur.

The appliance is not intended for use by young children or infirm persons without supervision.

The remote controller should be installed in such away that children cannot play with it.

— NOTE —

Never press the button of the remote controller with a hard, pointed object.

The remote controller may be damaged.

Never pull or twist the electric wire of the remote controller.

It may cause the unit to malfunction.

Do not place the controller exposed to direct sunlight.

The LCD display may get discolored, failing to display the data.

Do not wipe the controller operation panel with benzine, thinner, chemical dustcloth, etc.

The panel may get discolored or the coating peeled off. If it is heavily dirty, soak a cloth in water-diluted neutral detergent, squeeze it well and wipe the panel clean. And wipe it with another dry cloth.

Dismantling of the unit, treatment of the refrigerant, oil and eventual other parts, should be done in accordance with the relevant local and national regulations.

CONTENTS

<p>SAFETY CONSIDERATIONS1</p> <p>FEATURES AND FUNCTIONS3</p> <p>NAMES AND FUNCTIONS OF OPERATING SECTION4</p> <p>OPERATION5</p> <p>Setting present time5</p> <p>Setting no. of programmed time6</p>	<p>Change and cancellation of no. of programmed time7</p> <p>Manual operation9</p> <p>Operation control code9</p> <p>Error diagnosing function9</p> <p>QUESTION AND ANSWER10</p> <p>SPECIFICATIONS12</p> <p>Specifications12</p> <p>Outline drawings12</p>
---	--

FEATURES AND FUNCTIONS

■ **Operation controlled by programmed time**

Operating time and stopping time can be set to the minute by each day of the week. The operating and stopping patterns can also be set in schedule according to the time slot given twice a day in tune with the uses.



See page
5—9.

■ **Unified Operation/Stop**

By using this schedule timer, the unified operation/stop of the indoor unit can be executed manually regardless of the No. of programmed time in operation.











See page
9.

• **When used in conjunction with central remote controller (Optional Accessory)**

The operation controlled by programmed time can be set for up to eight different patterns (timer No. 1 – 8). Each schedule pattern can be also selected.

NAMES AND FUNCTIONS OF OPERATING SECTION (Fig. 1, 2)

1	UNIFIED OPERATION BUTTON “ ALL ” 	Press this button to perform the unified operation regardless of the No. of programmed time.	9	DISPLAY “ <small>MÓN TUE WED THU FRI SAT SUN</small> CLOCK <small>AM PM</small> 12:00 ” (PRESENT TIME)	Displays the present day of the week and time.
	2			UNIFIED STOP BUTTON “ ALL ○ ” 	
3	OPERATION LAMP (RED)	The light turns on during the operation of the indoor unit.	11	DISPLAY “ <small>OFF</small> 12:00 ” (PROGRAMMED TIME OF SYSTEM OFF) <small>AM PM</small>	Displays the time programmed to stop.
	4			DISPLAY “ <small>NO.</small> 8 ” (TIME NO.) <small>⊕</small>	
5	DISPLAY “PROGRAM ↵ START.” (PROGRAMMING START)	The light turns on when the timer is programmed.	13	CLOCK ADJUSTING BUTTON “ CLOCK ” 	Press this button to set the present time.
	6			DISPLAY “ OFF ” (HOLIDAY SETTING)	
7	DISPLAY “ — ” (SETTING OF DAYS OF A WEEK)	Flashes below the day of the week programmed.	15	BUTTON FOR SELECTING DAYS OF A WEEK “  ”	Press this button to select the day of the week.
	8			DISPLAY “  ” (MALFUNCTION CODE)	

17	TIMER ON BUTTON “  ”
	Press this button to set the present time and the programmed time.
18	HOLIDAY SETTING BUTTON “  ”
	Press this button to set holidays.
19	BUTTON FOR COPYING PROGRAM OF PREVIOUS DAY “  ”
	Use this button to set the No. of programmed time same as that of the previous day.
20	PROGRAM CANCELING BUTTON “  ”
	Use this button to set the programmed time to cancel. The display shows “-;--”.
(Note) 1. Please note that all the displays in the figure appear for explanation purpose or when the cover is open.	

OPERATION

■ Setting present time (Fig. 3)

(Example) In case of setting Friday, 5:30 p.m.

1.  Press the **CLOCK ADJUSTING BUTTON**. The present time display flashes.

(NOTE)

- The present time needs adjusting in case of turning power supply on for the first time or the occurrence of power failure over the period of 48 hours or more.



2.  Press the **BUTTON FOR SELECTING DAYS OF A WEEK**. Each time the button is pressed, the day display shifts to the right.

(NOTE)

- The display “ MON ” follows the display “ SUN. ”

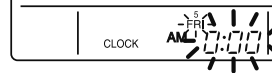

Set the day to Friday.

3.  Set the time with the **HOUR/MINUTE BUTTON**. Each time the HOUR/MINUTE BUTTON is pressed, the display is put forward minute by minute and hour by hour. When the button is kept pressed, the display is put forward continuously.

(NOTES)

- After becoming “ AM 11:00 ”, when the button is pressed, the display becomes “ PM 0:00 ”.
- After becoming “ 59 ” (minute), when the button is pressed, the display becomes “ 00 ” (minute).

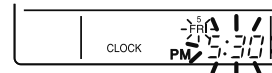

Set the time to 5:30 p.m.

4.  Press the **TIMER ON BUTTON** the moment the time signal of TV, radio, telephone, etc. is heard. The mark “ : ” flashes, and the clock starts.

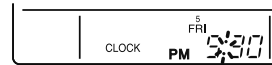

Press the **TIMER ON BUTTON** in tune with the time signal at 5:30 p.m.

(NOTES)

- The clock used is of 12-hour type.
- When you turn power supply on, the system may display “ 88 ” for about one minute and not start to operate after all the liquid crystal displays appear at a time.
- If the **CLOCK ADJUSTING BUTTON** is pressed by mistake, press it again to return to the original state. As the clock does not stop, the time indicated by the clock is kept correct. In case of power failure within 48 hours, the clock keeps operating by utilizing the built-in battery.

■ Setting no. of programmed time (Fig. 4)

(Example) Time No. 5 (to be programmed only when used in conjunction with the central remote controller)

Monday to Friday:

Operating from 8:45 a.m. till 5:00 p.m.

Operating from 5:15 p.m. till 11:00 p.m.

Saturday and Sunday:

Setting the whole day stop operation (application for holidays) controlled by programmed time.

1. Press the PROGRAMMING START BUTTON. Programming is available. The display "PROGRAM J START" appears, and the display of days of a week flashes.

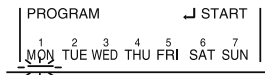

2. Press the TIME No. BUTTON, and select the desired number.

(NOTE)

- Unless used in conjunction with the central remote controller, The TIME No. is not displayed and can not be selected.

Select the TIME No. 5.

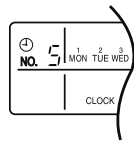

3. Press the BUTTON FOR SELECTING DAYS OF A WEEK, and set the proper day of the week. Each time you press it, the flashing display of days of a week shifts to the right.



Set to Monday.

(1) Setting programmed time

4. Set the programmed time of system start 1 by using the HOUR/MINUTE BUTTON. Each time the HOUR/MINUTE BUTTON is pressed, the display is put forward minute by minute and hour by hour. When the button is kept pressed, the display is put forward continuously.



Set the "PROGRAMMED TIME OF SYSTEM START 1" at 8:45 a.m.

5. Press the TIMER ON BUTTON, and set the programmed time of system start 1. Each time you press it, the next area to be set flashes.

(NOTE)

- Set the other programmed time in the same procedure.

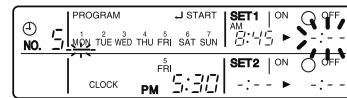

- (2) **Set the next day of the week.**
 Set the day of the week to Tuesday, and copy the program of the previous day (Monday). In the same procedure, set the day of the week to Wednesday through Friday in sequence.

6.  **Press the BUTTON FOR SELECTING DAYS OF A WEEK and set the following day. Press the BUTTON FOR COPYING PROGRAM OF PREVIOUS DAY. The same program as that of the immediately preceding day of the week is set.**

(NOTE)

- Repeat each procedure 3 – 5 in the above when not copying the contents of the previous day.

- (3) **Holiday setting**

7.  **Press the BUTTON FOR SELECTING DAYS OF A WEEK and set one or more days of the week as holiday. Press the HOLIDAY SETTING BUTTON, and the display “ OFF ” is displayed at the top of the day of the week. If you press it again, the display returns to the original state.**

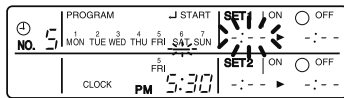

Set Saturday and Sunday as holidays.

8.  **Press the PROGRAMMING START BUTTON, and finish the program setting.**

(NOTES)

- Unless the button is pressed within 20 minutes, the display will automatically revert back to the original state. In this case, setting contents up to the point where the TIMER ON BUTTON (or HOLIDAY SETTING BUTTON or BUTTON FOR COPYING PROGRAM OF PREVIOUS DAY) is pressed will only take effect.
- The display “ PROGRAM ↵ START ” and the display of days of a week “ — ” disappears.

- The flashing display goes off, and the No. of programmed time of the present day is displayed. Then the operation controlled by timer starts.
- The operation controlled by timer is executed even while the program is being set.





This is the end of the setting example.

■ Change and cancellation of no. of programmed time (Fig. 5)

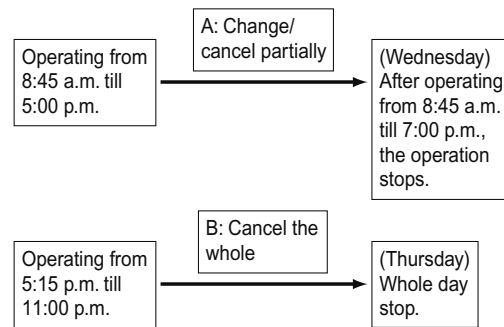
(Example) **Time No. 3 (to be set only when used in conjunction with the central remote controller)**



-  **Press the PROGRAMMING START BUTTON. The program setting is ready. The display “ PROGRAM ↵ START ” appears, and the display of days of a week flashes.**
-  **Press the TIME No. BUTTON, and select the desired No.**

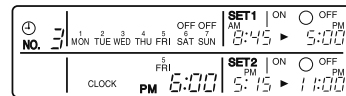

Select the time No. 3.

3.  Press the **BUTTON FOR SELECTING DAYS OF A WEEK**, and set the day of the week to be changed. The set No. of programmed time of the day of the week is displayed.

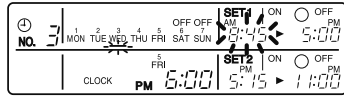

Set the day to Wednesday.

A. Change/cancel partially

4.  Press the **TIMER ON BUTTON** and change, and the display of programmed time flashes. Each time you press it, the next area to be set flashes.

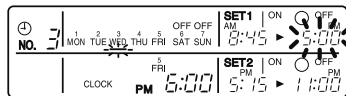

Shift to the display "PROGRAMMED TIME OF SYSTEM OFF 1".

5.  Press the **HOUR/MINUTE BUTTON** and change the programmed time. Press the **TIMER ON BUTTON**, and finalize the setting of change.

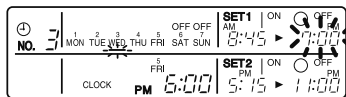

Change the "PROGRAMMED TIME OF SYSTEM OFF 1" to 7:00 p.m.

6.  Press the **PROGRAM CANCELING BUTTON**, and cancel the programmed time. If you press it again, display returns to the original state. Press the **TIMER ON BUTTON** to finalize the cancellation.



Shift to the "PROGRAMMED TIME OF SYSTEM START 2".

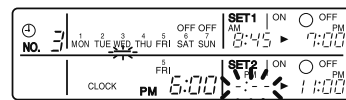

Set the "PROGRAMMED TIME OF SYSTEM START 2" to program cancellation.

In the same procedure, cancel the programmed time of system off 2.

B. Cancel the whole

7.  Press the **BUTTON FOR SELECTING DAYS OF A WEEK**, and shift to the day of the week to be canceled. Then, press the **HOLIDAY SETTING BUTTON**, the display "OFF" appears at the top of the particular day of the week. The programmed time is canceled. If you press the button again, the display returns to the original state.

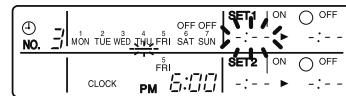

Shift the day of the week to Thursday to set as a holiday.



8.  Press the **PROGRAMMING START BUTTON**. The program setting is now finished.

(NOTES)

- Unless the button is pressed within 20 minutes, the display will automatically revert back to the original state. In this case, setting contents to the point where the **TIMER ON BUTTON** (or **HOLIDAY SETTING BUTTON** or **BUTTON FOR COPYING PROGRAM OF PREVIOUS DAY**) is pressed will only take effect.
- To continue the change/cancellation, do not press the **PROGRAMMING START BUTTON** until all change/cancellation are completed.
- The operation controlled by timer is executed even while the program is being set.

■ Manual operation (Fig. 6)

This schedule timer enables the operation/stop by pressing the **UNIFIED OPERATION/STOP BUTTON** in addition to the operation controlled by timer (operation/stop according to the programmed time) at any time.

1.  Press the **UNIFIED OPERATION BUTTON**, and the **OPERATION LAMP** turns on.
2.  Press the **UNIFIED STOP BUTTON**, and the **OPERATION LAMP** is turned off.

(NOTES)

- The operation automatically stops according to the programmed time of system off even during the manual operation. In the meantime, the operation starts automatically according to the programmed time of system start even during the stop of operation.
- If the unit is used in conjunction with other optional controllers for centralized control, the **OPERATION LAMP** of the unit that is not under operation control may be turned on or off a few minutes behind schedule. This shows that the signal is being exchanged, and does not indicate any failure.

Operation lamp

- Turn on: The light turns on when any of the indoor units is in operation whether the operation is controlled by timer or by hand.
- Turn off: The light turns off when all the indoor units stop.

■ Operation control code

Two different types of operation control codes can be selected when this kit is used independently (when not used in conjunction with the central remote controller, unified ON/OFF controller, etc.).

Individual

In case where the operation/stop is controlled by both schedule timer and remote controller.

Centralized

The operation is controlled by the schedule timer alone, and the operation/stop is controlled freely with the remote controller during the programmed time.

(NOTES)

- For current settings, contact your DAIKIN dealer.
- To change settings, contact your DAIKIN dealer.
Do not change settings yourself.

■ Error diagnosing function (Fig. 7)



This schedule timer is provided with the malfunction diagnosing function. The malfunction code flashes if there occurs any malfunction in communication, etc. between and among the optional controllers for centralized control. In addition, the operation lamp also flashes if there occurs any malfunction in communication with the indoor unit. Check the contents of the display and contact your DAIKIN dealer because the signals give you the idea of the trouble area.

Operation lamp	Malfunction code	Contents of malfunction
Turn off	M1	Failure of PC board of schedule timer. Fixes The following causes are possible. Check each one. 1. PC board problems
Turn on or off	M8	Malfunction of transmission between each optional controllers for centralized control. Fixes Check all central devices which are connected (e.g., power supply, transmission wiring, etc.).
Turn on or off	MA	Improper combination of optional controllers for centralized control. Fixes The following causes are possible. Check each one. 1. Are all central devices combined correctly? 2. Is the master central connector attached to two or more central devices? 3. Are there 128 or more indoor units connected?

Turn on or off	MC	Address failure of schedule timer. Fixes The following causes are possible. Check each one. 1. Do the control range addresses in the central remote controller overlap? 2. Do the control range addresses in the on/off controller overlap? 3. Are there 2 or more schedule timers connected?
Flash	UE	Malfunction of transmission between indoor unit and optional controllers for centralized control. Fixes Inspect all indoor units which are displaying an error (e.g., power supply, transmission wiring, etc.).
Flash	—	Malfunction in indoor unit (Refer to the malfunction codes of the indoor remote controller, while also read the "CAUTION FOR SERVICING" attached to the indoor unit.)

QUESTION AND ANSWER

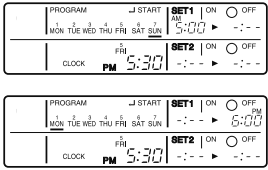
Question	Answer
It is possible to make settings twice a day, but is it possible to make only the "off" setting? (To avoid forgetting to turn the unit off.)	Yes. Press the PROGRAM CANCELING BUTTON in the "AM/PM ON 12:00" section in order to set it to "OFF".

<p>Is it possible to set times which straddle days?</p>	<p>Yes, it is possible. Example: Start operation at 5:00 a.m. on Sunday Stop operation at 6:00 p.m. on Monday</p> 	<p>The TIME NO. is not displayed.</p>	<p>The following causes are possible. 1. The TIME NO. is not displayed when using the schedule timer alone. (It can be set if using the central remote controller at the same time.)</p>
<p>The unit does not turn on even though the set "on" time has come. (When using the schedule timer alone)</p>	<p>The following causes are possible. 1. Are the "on" time and the "off" time set to the same time?</p>	<p>The display remains</p>  <p>even though I push the HOUR/MINUTE BUTTON in the timer program settings.</p>	<p>The following causes are possible. 1. Is the day set to a holiday?</p>
<p>The unit does not turn on even though the set "on" time has come. (When using the unit with a central remote controller)</p>	<p>The following causes are possible. Check each one. 1. Was the timer number set with the central remote controller? Was an incorrect timer number set? 2. Is another timer no. set with the central remote controller set for "off" at the same time? 3. Is the operation code set to "remote control permission timer" using the central remote controller or the on/off controller?</p>	<p>I cannot set "central management priority" or "after-push priority" with the schedule timer.</p>	<p>The following causes are possible. 1. Is a central remote controller or on/off controller also installed? * The priority order of the operation codes depends on the central devices which are installed. The below operation codes are set. • Schedule timer Central remote controller is used as well Operation code of the central remote controller • Schedule timer On/off controller is used as well Operation code of the on/off controller • Schedule timer Central remote controller On/off controller is used as well Operation code of the central remote controller</p>
<p>The unit operates even though that day is set as a holiday. (When using the unit with a central remote controller)</p>	<p>The following causes are possible. 1. Is another timer number set with the central remote controller set for "on" at the same time? (If two timer numbers are set, make sure that the settings for holidays and working days do not overlap between the different timer numbers.)</p>		

2.11 <KRP928BB2S> Interface Adaptor for DIII-NET

Safety Precautions

- Read these Safety Precautions carefully to ensure correct installation. This manual classifies precautions into WARNING and CAUTION.

WARNING : Failure to follow WARNING is very likely to result in such grave consequences as death or serious injury.

CAUTION : Failure to follow CAUTION may result in serious injury or property damage, and in certain circumstances, may result in a grave consequence.

Be sure to follow all the precautions below ; they are all important for ensuring safety.

WARNING

- Installation should be left to the dealer or another qualified professional.** Improper installation by yourself may cause malfunction, electrical shock, or fire.
- Install the set according to the instructions given in this manual.** Incomplete or improper installation may cause malfunction, electrical shock, or fire.
- Be sure to use the standard attachments or the genuine parts.** Use of other parts may cause malfunction, electrical shock, or fire.
- Disconnect power to the connected equipment before starting installation.** Failure to do so may cause malfunction, electrical shock, or fire.
- A ground fault circuit interrupter / an earth leakage circuit breaker should be installed.** If the breaker is not installed, electrical shock may occur.

CAUTION

- Do not install the set in a location where there is danger of exposure to inflammable gas.** Gas accumulated around the unit at the worst may cause fire.
- To prevent damage due to electrostatic discharge, touch your hand to a nearby metal object (doorknob, aluminum sash, etc.) to discharge static electricity from your body before touching this kit.** Static electricity can damage this kit.
- Lay this cable separately from other power cables to avoid external electrical noises.**
- After installation is complete, test the operation of the PCB set to check for problems, and explain how to use the set to the end-user.

1. Overview, Features and Compatible Models

This kit is the interface required when connecting the central controller and a Room Air Conditioner. Use of the central controller makes it possible to perform the following monitoring and operations. It is compatible with room air conditioners which have an HA connector S21.

- Run / stop for the central controller and wired remote controller, operating mode selection, and temperature can be set.
- The operating status, any errors, and the content of those errors can be monitored from the central controller and wired remote controller.
- Run / stop for the central controller and wireless remote controller, operating mode selection, and the temperature setting can be limited by the central controller.
- Zone control can be performed from the central controller.
- The unit can remember the operating status of the air conditioner before a power outage and then start operating in the same status when the power comes back on.
- Card keys, operating control panels, and other constant / instantaneous connection-compatible equipment can be connected.
- The Operating / error signals can be read.
- The indoor temperature can be monitored from the iTM / iTC.

Precaution

- When reading the Operating / error signals, a separate external power source (12 V DC) is needed.
- A separate timer power source (16 V DC) is needed when using the schedule timer independently, and not in conjunction with other central controllers.
- The range of temperatures that can be set from the central controller is 18°C to 32°C in cooling and 14°C to 28°C in heating.
- Fan operation cannot be selected from the central controller or wired remote controller.
- Group control (i.e., control of multiple indoor units with a single remote controller) is not available.
- Monitoring is not available of the thermo status, compressor operating status, indoor fan operating status, electric heater, or humidifier operating status.
- Forced thermo off, filter sign display and reset, fan direction and speed settings, air conditioning fee management, energy savings instructions, low-noise instructions, and demand instructions cannot be made.

2. Component Parts

This kit includes the following components. Check to ensure that none of these are missing.

Parts	Q'ty	Parts	Q'ty
 Kit assy PCB is in the housing.	1	Connection harness (about 1.6m)	1
		Mounting screws	3
		Binding band	6
		Installation manual	2

3. Names of Parts and Electric Wiring

<Wiring procedure>

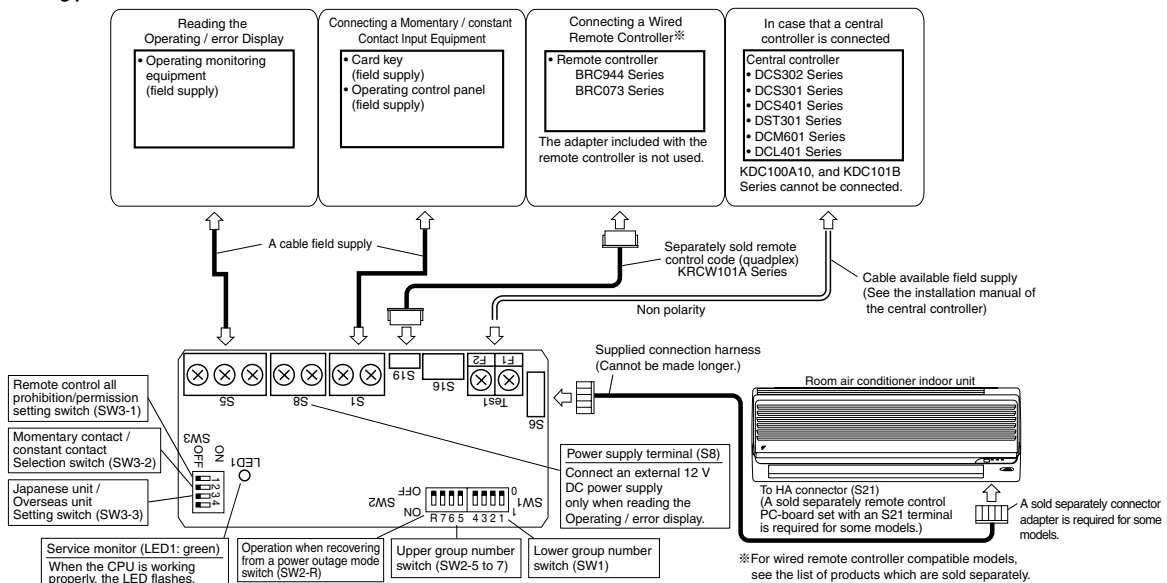

4.Switch Settings

NOTE Turn the power on after all the switches have been set. Settings made while the power is on are invalid.

Open the Kit's case and set the switches on the circuit board.
 (1) For Overseas / Japanese unit setting (SW3-3)
 Room air conditioners, different methods are used for setting the temperature in automatic mode, so this switch needs to be set.

Destination	SW3-3 setting	What Happens
Japan	OFF (Factory setting)	• "Automatic" operation is not available from the central controller. When using "automatic" operation using the wireless remote controller, the central controller displays automatic cooling (heating) and 25°C. Even if the temperature is changed, it will return to 25°C after a while.
Overseas	ON	• "Automatic" operation is available from the central controller.

(2) Group number settings (SW1 and SW2-5 to SW2-7)
 Set these when using the central controller. (Set to the side.) Do not set more than one unit to the same number.
 Use SW2-R for (3) Settings when recovering from a power outage.

However, these settings do not need to be made when using the schedule timer independently.
 (The settings are needed when used in conjunction with another DCS Series central controller.)
 In this case, the schedule timer performs an auto address after the power is turned on, so new group numbers are automatically set. Settings made using the switches will be overwritten.

Group NO. Upper settings SW2		Group NO. Lower settings SW1	
1-4	5-8	00-03	04-15
:Use with power failure recovery settings Set to the side :ON :OFF			

NOTE also that a separate timer power source is needed when using the schedule timer independently.
 Power source specs: 16 V DC, +10%, -15%, 200mA.

(3) Settings when recovering from a power outage (SW2-R)
 This selects whether to restart operation when the power comes back on after a power outage occurred during operation. This setting is given priority in cases where the indoor unit has an auto start ON / OFF jumper. Note also that regardless of whether switch SW2-R is on or off, the operating mode (NOTE), set temperature, fan direction and speed settings, and remote control prohibition status are stored.

SW2-R setting	What Happens
OFF (Factory setting)	Stops after recovering from a power outage
ON	Stops if the unit was stopped before the power outage and runs if it was running.

(NOTE) The following settings apply to the models below.

Mode before the power outage	COOLING	HEATING
Room air conditioner		
Models with humid heating and dehumidifying functions.	DRY COOLING	HUMID HEATING
Models with dehumidifying function.		HEATING

(4) Contact input function settings (SW3-1 to SW3-2)
 When using contact input (S1), choose one of the following functions.

S1 operating mode	SW3-1 setting	SW3-2 setting	What Happens	Control mode
Instantaneous contact input (factory setting)	OFF	OFF	The operating status of the air conditioner is reversed by an instantaneous input of 100 msec or more.	Last command priority
	OFF	ON	Contact - Open to close: air condition runs. Close to open: air conditioner is stopped (NOTE 1).	ON / OFF control is rejected (operate / stop / timer prohibition) (NOTE 2).
Remote control all prohibition/permission input	ON	Invalid	Contact - Open to close: air condition stops. Close to open: no change in operating status.	All remote controller actions are prohibited when the contact is closed. (NOTE 3)

NOTE1: Since central controller uses last command priority, the contact status and operating status of the air conditioner might not match sometimes.
 Example: If the unit is run from the central controller while the air conditioner is stopped with an open contact, the contact will be open and the unit will be running.

NOTE2: Operating mode and fan direction and speed settings can be changed.

NOTE3: If the contact is closed while the ON timer is set, as the power ON timer function is still operating, the operation starts at the time specified by the timer. To prevent operation of the power ON timer, use of the (KRP413BB1S) remote control PC-board set is recommended. However, note that it cannot be used in tandem with the central controller.
 If this product is connected to an air conditioner manufactured in or after 2011, when the contact is closed, the power ON timer may be cancelled depending on the combination with the model.

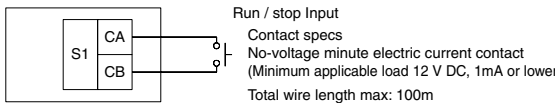

5.Control Codes

When using a central remote controller, the operating codes can be used to limit operation from wireless remote controllers. Three beeps for signal reception will be heard continuously when the wireless remote controller is operated while in central control.
 ○ : permitted; × : prohibited

S1 operating mode	Control mode	Control code	Operations from the remote controller								
			"Run" control from the central controller				"Stop" control from the central controller				
			Run / timer	Stop	Operating mode temperature	Fan direction and fan speed	Run / timer	Stop	Operating mode temperature	Fan direction and fan speed	Operations from central controller and contact input
Instantaneous contact mode	ON / OFF control is rejected	0,1,3	×	×	×	×	×	×	×	×	○
		10,11	×	×	×	×	×	×	×	×	
	Only OFF control is accepted	2	×	○	×		×	×	×		
		12-19	×	○	×		×	×	×		
		4	○	○	○		×	×	×		
Constant contact mode	Central priority	5	○	○	○		×	×	×		
		6,7	○	○	○		×	×	×		
	Last command priority	8	○ [※]	○ [※]	○ [※]		×	×	×		
		9	○ [※]	○ [※]	○ [※]		×	×	×		
		2,10-19				×				×	
All remote controller actions are prohibited	Timer operation is accepted by remote controller	0,1,3,5-7								○	
		4	×	×			×	×		○	
		8								×	
		9								○	

※Only during timer operation
 The remote controller permission / prohibition settings using the iTM / iTC are as follows.
 ○ : permitted; × : prohibited

S1 pin operating mode	iTM / iTC settings			Operations from the remote controller			Operations from central controller and contact input
	Start / stop	Change operating mode	Change set temperature	Run / timer	Stop	Operating mode temperature	
Instantaneous contact mode	ON / OFF control is rejected	permitted	permitted/prohibited	×	×	○	○
		prohibited	permitted/prohibited	×	×	×	
Constant contact mode	Only OFF control is accepted	permitted	permitted/prohibited	×	×	○	○
		prohibited	permitted/prohibited	×	×	×	
Instantaneous contact mode	Last command priority	permitted	permitted/prohibited	○	○	×	○
		prohibited	permitted/prohibited	×	×	×	
Constant contact mode	Last command priority	permitted	permitted/prohibited	×	×	×	○
		prohibited	permitted/prohibited	×	×	×	
All remote controller actions are prohibited				Does not affect settings	×	×	×

6.Read Operating / Error Display Signal

The Operating / error signals can be read from the contact output (S5).
 Output specs
 M1: Turn MR 1 ON when the air conditioner is running.
 M2: Turn MR 2 when a communication error has occurred between the KRP928BB2S and the air conditioner, or MR 1 is ON and the unit has stopped after an error.
 MR 2 is not turned ON during a warning.

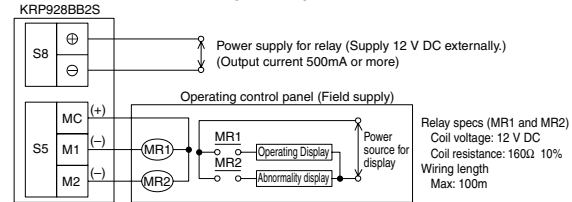

7.Combining Equipment

The central controller can be combined with the following devices.

	Central Remote Controller	ON / OFF controller	Schedule timer	D-BIPS	Contact input	Wired Remote Controller	Wireless Remote Controller
Central Remote Controller	○	○	○	○	○	○	○
ON / OFF controller	○	○	○	○	○	○	○
Schedule timer	○	○	×	×	○	○	○
D-BIPS	○	○	×	×	○	○	○
Contact input	○	○	○	○	×	○	○
Wired Remote Controller	○	○	○	○	○	×	×
Wireless Remote Controller	○	○	○	○	○	×	○

Connection to Remote Control PC-board

1. Removal of upper HA casing

① Insert a flat-blade screwdriver into the groove between the upper and lower casings.

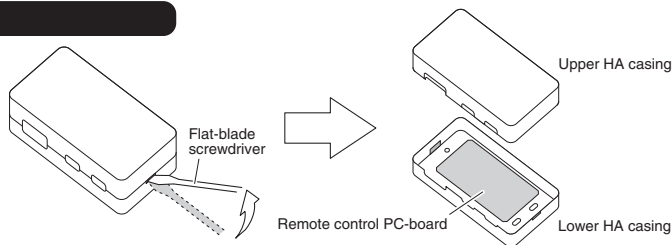

② Lift the handle of the screwdriver upward.

2. Securing of lower HA casing

Mount and secure the lower HA casing directly on the wall with the provided screws inserted into the screw holes (a round hole and two ellipse holes) of the casing.

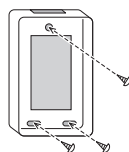

NOTE

Mount the HA casing in a direction where the wiring through-holes will be hidden in order to prevent infants from putting their fingers into the HA casing and the LED light on the internal PC board from leaking outside.

3. Connection of wiring

Connect the wiring to the connector terminals.

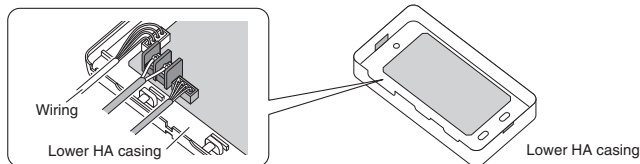

4. Fixation of wiring

① Insert the provided binding band under the pillar of the HA casing and secure the covers of the wiring with the binding band.

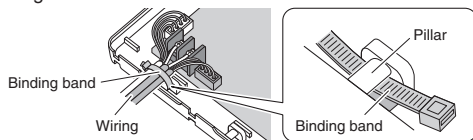

② Insert the second binding band into the groove on the side of the HA casing and fix the wiring securely so that the wiring will not be disconnected.

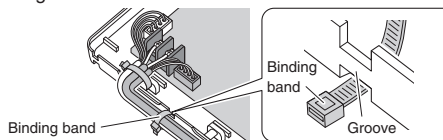

A large number of wires

Make a slit with an appropriate tool, such as a cutter knife, on the thin part of the upper HA casing along the frame. Then cut the part with an appropriate tool, such as a pair of nippers.

(NOTE) Cut off only the thin part required for wiring.

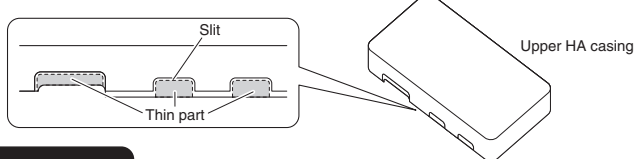

5. Finishing

Mount the upper HA casing to the original position.

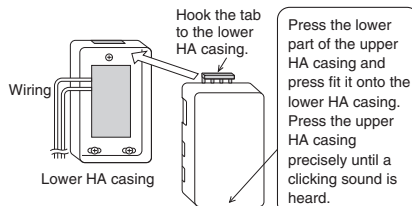

Information

When the contact input device (such as card keys) and central controller are used in tandem:

Even when the operating mode of the S1 pin is set to prohibit all remote controller actions, run/stop operation from the central controller is possible. The operation also starts when the power ON timer of the indoor unit is up while all remote controller actions are prohibited. (*) In this case, stop the operation from the central controller. For the compatible models of the (KRC944 series) remote controller, the operation can be prohibited by using the remote controller in tandem with the central controller. *If this product is connected to an air conditioner manufactured in or after 2011, when the contact is closed, the power ON timer may be cancelled depending on the combination with the model.

2.12 <KRP1C74/75> Wiring Adaptor

Accessories

Check if the following accessories are included in the kit.

Name	Adactor for wiring	Harness	PCB support	Clamp	Installation manual
Shape					
Quantity	× 1	× 1	× 4	× 3	× 1

Notes

- Kits vary according to applicable models.
- A special adaptor fixing plate and box are required for the following models.
 FXSQ~T KRP4A98
 FXZQ KRP1BA101

< Caution >

- All wiring must be performed by an authorized electrician.
- For electric wiring work, refer to also "Wiring diagram" attached to the control box lid and this manual.
- All wiring must be worked after shutting down power supply.
- All field supplied parts and materials and electric works must conform to local codes.
- A circuit breaker capable of shutting down power supply to the entire system must be installed.

1 Names of parts

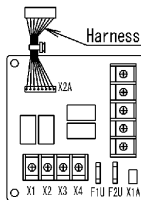

This function can not be used.
 Terminals for controlling auxiliary heater, humidifier, and other equipment.

Terminals for operation status

2 Electric wiring

- Refer to the wiring diagram attached to the indoor unit before attempting to wire.
 [Make sure wires to units do not pass over the PCB when wiring.]
- Wire the adaptor to the indoor unit as shown below.

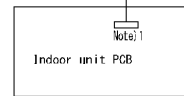
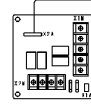

Note) 1 Connector No.
 X16A: FXLQ, FXNQ, FXMQ~M, FXDQ, FXHQ, FHQ, FXZQ~M
 X33A: FXTQ, FTQ, FXMQ~P, FXFQ, FCQ, FBQ, FXEQ
 FXSQ~T, FXZQ~T

1 Thermo-ON and Fan ON status

- Thermo-ON status
 Contact terminals X1 and X2 close while the indoor unit is Thermo-ON (call for cooling or heating)
- Fan ON status
 Contact terminals X3 and X4 close when indoor unit fan is ON

Example: Obtaining status

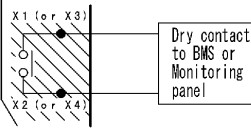

Example: Interlock

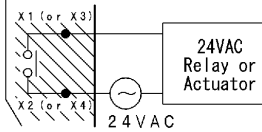

2 Interlocking Humidifier and Heater

- Humidifier output (Y2-YC)
 • Energized while heating Thermo-ON (call for heating)
- Heater output (Y1-YC)
 • Auxiliary heater output with heat pump heating
 • Primary heater output when heat pump lockout enabled

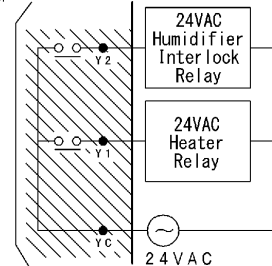

3 Installation

- Installation differs according to models as shown below.
- Do not bundle low and high voltage wires together.
- Bundle any excess wires with the attached clamps so as to keep loose wires off the indoor unit PCB.

< Ceiling mounted duct type >

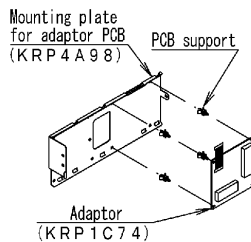

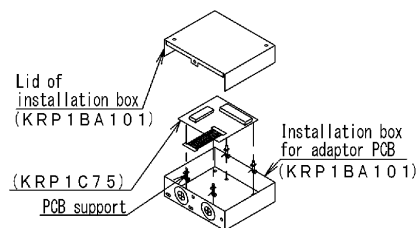

< Ceiling mounted cassette type (2' X2') >

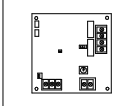

2.13 <KRP4A74> Wiring Adaptor

Accessories Check if the following accessories are included in the kit.

Adaptor	Relay harness	PCB support	× 4
× 1	(1) × 1 each	Clamp	× 3
	(2) 	Installation manual	× 1

Notes

- Kits vary according to applicable models.
- A special adaptor fixing plate and box are required for the following models.

1 System outline

This kit enables remote control (ON/OFF control, temperature setting, operation display, error display) and can be used with the following systems though it cannot be used in conjunction with other optional controllers for centralized control.

1. Individual control (Each indoor unit is controlled individually.)

This system requires the following parts.

- Adaptor.....KRP4A71 - 72 - 73 - 74 Any one kit
- Remote controller.....BRC1E71 (For operation control)

(Ex.)When individually controlling 8 FXS012MVJU units
KRP4A71×8 kits
BRC1E71×8 kits

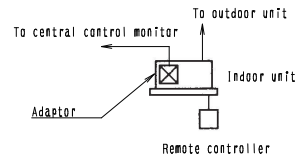

2. Group control (Multiple indoor units are controlled as a group.)

This system requires the following parts.

- Adaptor.....KRP4A71 - 72 - 73 - 74 Any one kit
- Remote controller (For operation control).....BRC1E71

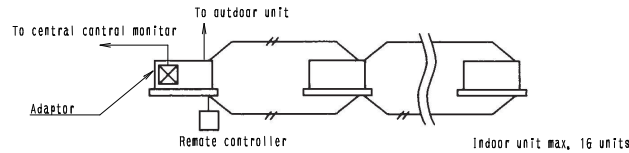

2 Names of parts and function

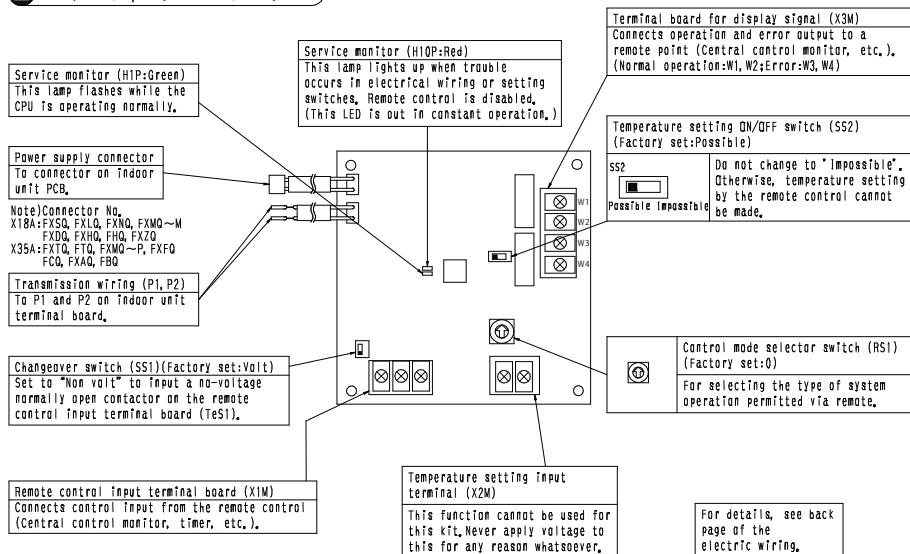

3 Installation

<Ceiling-mounted cassette type>

[XFQ] (Fit the edge of the adaptor PCB into the grooves on the adaptor box,)

[FCQ]

Lid of installation box
KRP1H98

Adaptor
(KRP4A74)

PCB support

Installation box
for adaptor PCB
KRP1H98

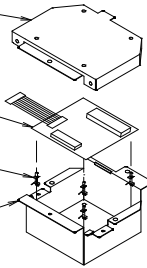

4 Electric wiring

- ① First, wire between the indoor and outdoor units, and then to the separate power sources, and finally between the indoor units and the remote controllers. Then, check if they operate properly. (If wiring for group control by remote controller, check crosswires.)
For details, see the installation manual of the indoor and outdoor units.
- ② Next, wire between outside units such as the central control monitor, etc. and make the necessary settings.
For details, see [Wiring to outside units(Central control monitor)].

Wiring to indoor units

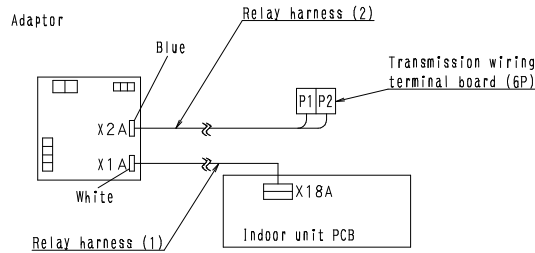

Make connections as shown above, using the attached relay harnesses (1) and (2) .

- Connect relay harness (1) to the connector (X18A) on the indoor unit PCB.
- Relay harness (2) has no polarity. Connect it to terminals P1 and P2 on the transmission wiring terminal board inside the indoor unit electric parts box.

Wiring to outside units (Central control monitor)

1. Remote control input (Operation control)
Wire as described below. Wiring differs depending on whether using a voltage or no-voltage input.

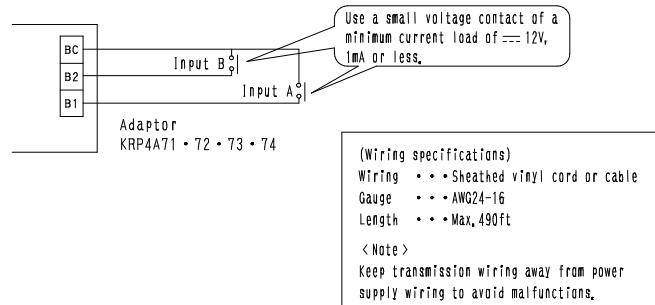
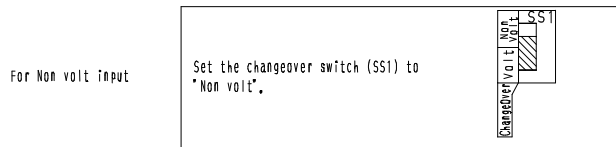
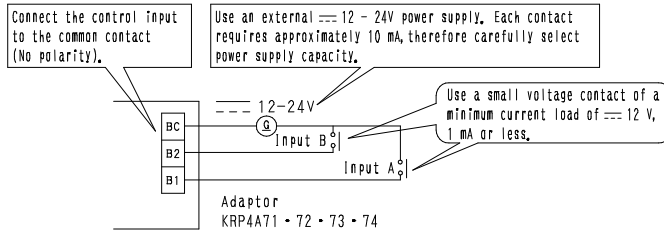
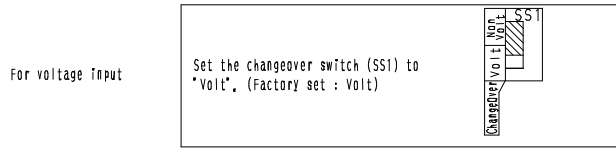

2. Setting the control mode selector switch (RS1)

Using the control mode selector switch (RS1), select the control mode as described below.



(Factory set)
"0" position

① For specifying individual display

Position	Function
0	Individual display (Input ignored)

② When operating the unit with constant input at input A

Position	Function	When input A is ON	When input A is OFF
1	ON/OFF control impossible by remote controller	Operation (Normally ON/OFF control impossible by remote controller)	OFF + ON/OFF control impossible by remote controller
2	Centralized	Operation + ON/OFF control possible by remote controller	
3	OFF control possible by remote controller	Operation + OFF control possible by remote controller (ON control impossible by remote controller)	
4	ON/OFF control possible by remote controller	ON/OFF control possible by remote controller (Operation impossible by optional controller)	

<Note>

- Input B is for forced ON/OFF input. When input B is ON, OFF control is possible but ON/OFF control by the remote controller is impossible, and input A is ignored. When it is OFF, input A is ignored even if selected. It is necessary to reselect input A.

③ When operating the unit using instantaneous input at input A
(Use an instantaneous input of 200 msec or longer ON time).

Position	Function	Input A	Input B capacity
5	ON/OFF control impossible by remote controller	Turns OFF system with ON input Turns ON system with ON input	Input B is for forced OFF input (when ON, OFF control is possible but ON/OFF control by remote controller is impossible, and input A is ignored)
6	Individual	Turns OFF system with ON input Turns ON system with ON input (Normally ON/OFF control possible by remote controller)	

★ For thermostat control using input B

Position	When input A is ON	When input B is ON
C	ON/OFF control impossible by remote controller (Same as position 5)	Forced thermostat OFF command
D		Energy saving command (*)
E	Individual (Same as position 6)	Forced thermostat OFF command
F		Energy saving command (*)

- Forced thermostat OFF command
Indoor unit fan only operates.
- Energy saving command (*)
The indoor unit operates at 4° F higher (cooling)/lower (heating) the set temperature.

<Note>

- In such case, even if input A is ON, thermostat control is turned OFF, and all units in the same group will stop.

④ When operating the unit using instantaneous input at input A and B
(Use an instantaneous input of 200 msec or longer ON time).

Position	Function	When input A is ON	When input A is OFF
7	ON/OFF control impossible by remote controller	Operation (Normally ON/OFF control impossible by remote controller)	OFF + ON/OFF control impossible by remote controller
8	Centralized	Operation + ON/OFF control possible by remote controller	
9	OFF control possible by remote controller	Operation + OFF control possible by remote controller (ON control impossible by remote controller)	
A	ON/OFF control possible by remote controller	ON/OFF control possible by remote controller (Operation impossible by optional controller)	
B	Individual	Operation (Normally ON/OFF control possible by remote controller)	OFF (Normally ON/OFF control possible by remote controller)

<Note>

- When set to position 7-A, and using the constant mode for input B, forced stop capacity is enabled (input A is ignored).
- At position B, the constant mode for input B is not used.

3. Cancelling display signals

Operation output terminals (W1 and W2) and error output terminals (W3 and W4) are no-voltage normally constant contacts,

(Allowed electric current per contact is between 10 mA and 3 A,)

Normal operation output (Ry1)
ON when the indoor unit is operating normally,

Error output (Ry2)
ON when the indoor unit stops because of malfunction or when a transmission error occurs between the adaptor and the indoor unit,

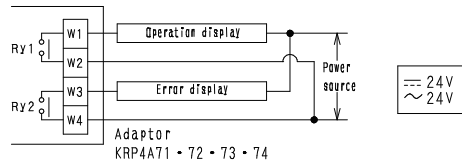

Display output is as described below,

Output	Both Ry1 and Ry2 OFF	Only Ry1 ON	Only Ry2 ON
Display	OFF	Normal operation	System stopped due to malfunction or transmission error generated between adaptor and indoor unit

2.14 <KRP4A98> Installation Box for Adaptor PCB

Precaution

- This is installable to the ceiling mounted duct type air conditioners and to the ceiling mounted cassette built-in type air conditioners.
- When mounting the adaptor plate, see also the indoor unit installation manual and the adaptor printed circuit board mounting instruction.
- Fixing method is not in the installation manual attached to the adaptor printed circuit board. Please follow directions on this sheet.

Accessories

- Check if the following accessories are included with your kit.

<Precaution>

The accessories are required for the installation of the air conditioner.
Be sure to keep them until the installation work is completed.

Name	adaptor plate(1)	adaptor plate(2)	Screws(1)	Screws(2)	Sealing material	Clamp	(Others)
Quantity	1PC.	1PC.	4PCS.	1PC.	2PCS.	10PCS.	Installation Manual
Shape							(This copy)

1 Mounting the adaptor plate

<Wiring to the indoor unit>

- (1) Remove the control box lid. For built-in type, open the terminal block fixing plate.
(The control box can be removed if it is hard to work.) [Fig. 1]
* For terminal blocks for remote control wiring (X2M) or terminal blocks for power wiring (X1M) If wiring is required, refer to the installation instructions for the indoor unit, connect the wiring before, installing the adapter mounting plate.
(In the case of duct type and back suction of built-in type.)
- (2) Connect the wiring attached to the adaptor printed board to the indoor unit. (The work is easier if the wiring is connected first.)
 - Refer to the instruction attached to the adaptor PCB for where to connect the wires.
 - Refer to Fig. 7 and 8. of **2 How to mount the adaptor printed circuit board and handle the wiring** for the connector location.

<Mounting the adaptor plate>

- When installing the adapter mounting plate after completing the wiring to the indoor unit
 - (1) Fix the adaptor plate (2) to the control box with the attached screws (1) at 2 locations. [Fig. 2]
 - (2) Attach the adaptor plate (1) to the control box with the attached screw (1) and attach adaptor plate (1) and (2) to the control box with the attached screw (2). [Fig. 3]
- When wiring to the indoor unit after installing the adapter mounting plate
 - (1) Remove one of the mounting screws (1) on the adaptor mounting plate (2), and then loosen the mounting screws (1) on the adaptor mounting plate (1) and (2) respectively. [Fig. 4]
 - (2) Move the adaptor mounting plates (1) and (2), and wire the **2 How to mount the adaptor printed circuit board and handle the wiring** and Perform the wiring according to the installation instructions supplied with the indoor unit. After installation, move the adaptor mounting plates (1) and (2) and return them to their original positions. [Fig. 5]
 - (3) Follow the reverse procedure of (1), screwing the mounting screws (1) of the adapter mounting plate (2) in two places, and then screw the mounting screws (1) of the adapter mounting plate (1) in two places. [Fig. 4]

<Caution>Make sure that the screws are securely fastened. There is a possibility that the adaptor mounting plate may come off.

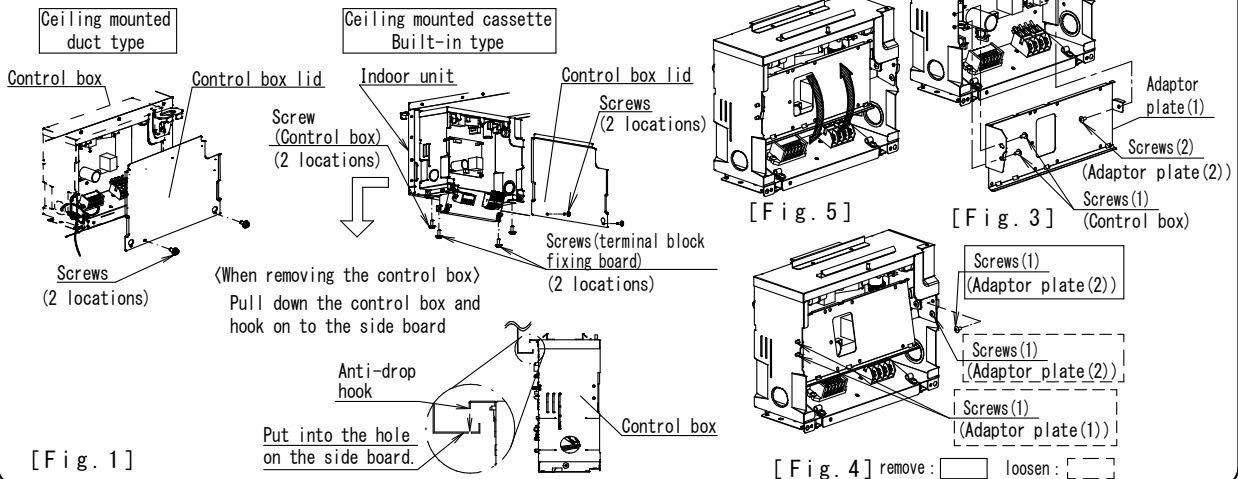

2 How to mount the adaptor printed circuit board and handle the wiring

<How to lead-in external wires>

Lay the high-voltage and low-voltage wires in the control box separately through the wire inlet on the side of the control box. [Fig. 6]

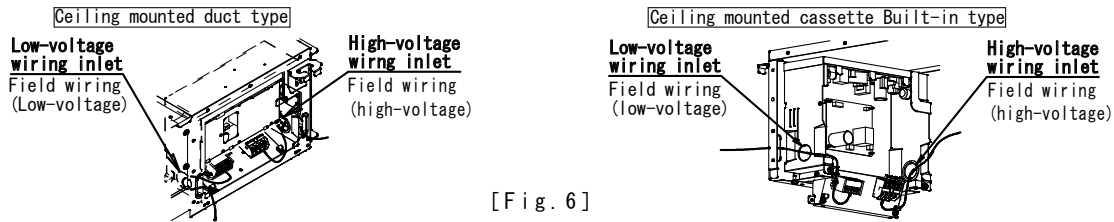

[Fig. 6]

《How to mount the adaptor printed circuit board》

- Connect the wiring to the adaptor printed circuit board.
(The work is easier if the wiring is connected to the printed circuit board first.)
 - See the instruction attached to the adaptor PCB for the connecting locations of wiring.
- Mount adaptor printed circuit board onto the adaptor plate in the direction as shown on Fig. 7 and 8.
 - Use printed circuit board supports attached to the adaptor PCB.

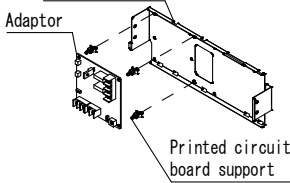

《Adaptor for wiring, Wiring adaptor for electrical appendices for group, Wiring adaptor for electrical appendices》

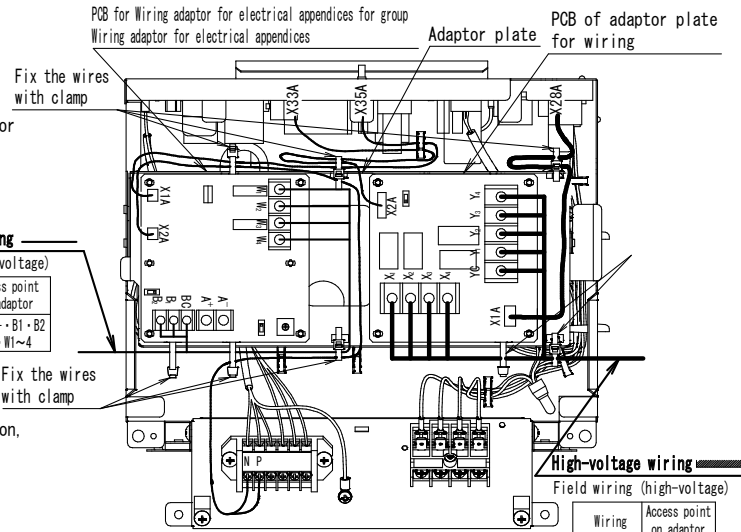

[Fig. 7]

《Caution》 If adaptor PCB is mounted in a wrong direction, electric noise may cause malfunction of the system or may influence upon other devices.

Adaptor PCB	Location to mount
Adaptor plate for wiring	KRP1C64 [Fig. 7]
Wiring adaptor for electrical appendices for group.	KRP4AA51 [Fig. 7]
Wiring adaptor for electrical appendices(※1)	KRP2AA61 [Fig. 7]
External control adaptor (※1)	DTA104A61 [Fig. 8]

Adaptor(※1) Only one adaptor can be mounted.

《How to handle the wiring》

《Caution》 Do not make high-voltage and low-voltage wires run in parallel.
Electric noise may cause malfunction of the system or may influence upon other devices.

- Fix the internal wiring. Fix the wiring to the adaptor plate with the attached clamps as shown on Fig. 7 and 8. (Put clamps through the corner holes to fix wires.)

Wiring	Access point on adaptor
Wiring on-site (low-voltage)	F1・F2・P3・P4 DEMAND CONTROL1~3 C・L・N・O

- Attach the control box terminal block fixing board and control box lid and wrap the wire sealing material around the wires so as to block the wire through hole. [Fig. 9]
 - Take precautions to prevent the wires from getting caught.
 - Fill in any gaps in the through holes with putty or insulation (Procured locally) to prevent small animals and insects from entering the unit from outside, which may cause short circuits in the control box.

⚠Warning

Trim and lay the wiring neatly and attach the control box lid securely. An electric shock or fire may result if the control box lid catches any wiring or the wires push up the lid.

- Fix the wiring fixture attached to the indoor unit with the wire fixing screws. Fix each wiring with the attached clamp materials. [Fig. 9]
 - See the instruction attached to the indoor unit.

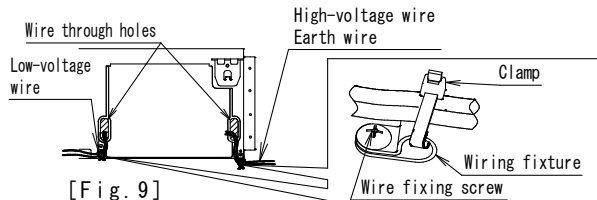

[Fig. 9]

《External control adaptor》

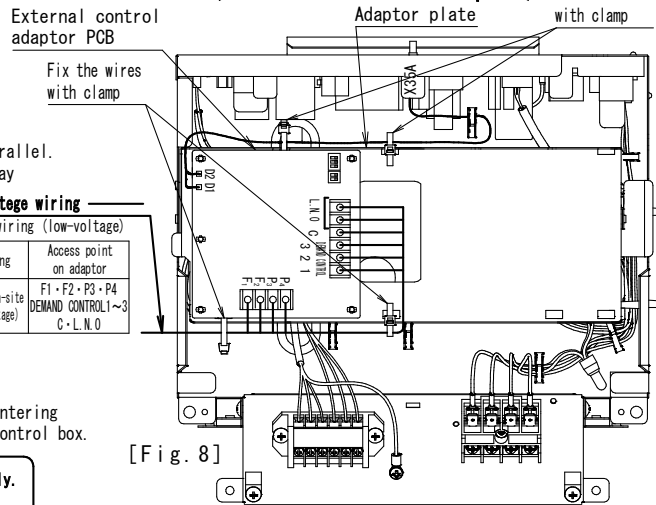

[Fig. 8]





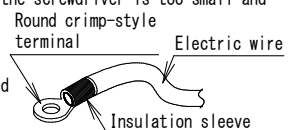

《Caution》

- Be sure to use round crimp-style terminal to connect to the terminal block. Provide insulation to the crimping part by attaching the insulation sleeve and such.
- Connect proper wires securely and fix the wires so that external force will not be imposed on the terminals.
- Use appropriate screwdriver to tighten the terminal screws. The screw heads may be damaged if the screwdriver is too small and terminal screws will not be tightend properly.
- Refer to the instruction attached to the indoor unit for the required tightening torque values of the terminal screws.

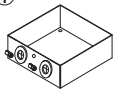
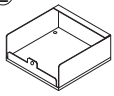

2.15 <KRP1BA101> Installation Box for Adaptor PCB

Accessories Check the following accessories are included in this kit.

Name	Installation box	Lid of installation box	Clamp	Screw	Cord sticker	Installation manual	Screw
Quantity	x1	x1	x3	x3	x3	KRP1B101 English KRP1BA101 Englishx1, Japanesex1	x2
Shape	① 	② 	③ 	④ 	⑤ 	⑥  (This manual)	⑦ 

① Method of attaching the adaptor

Attach the adaptor

Attach the adaptor in the installation box ① by the PCB supports.
(PCB supports are accessories of adaptor.)

- Detach the aluminum tapes of the installation box ① to insert the PCB support.

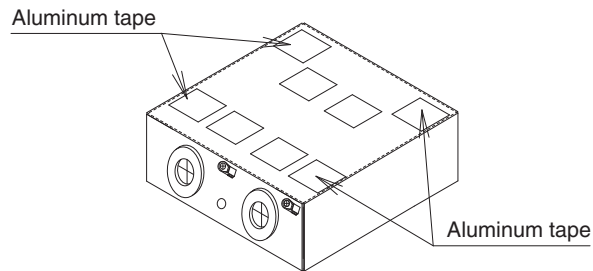

- Connect wires with the adaptor before attaching to the installation box ①.
- Low voltage wires and high voltage wires should be kept space at least 50 mm from each other.

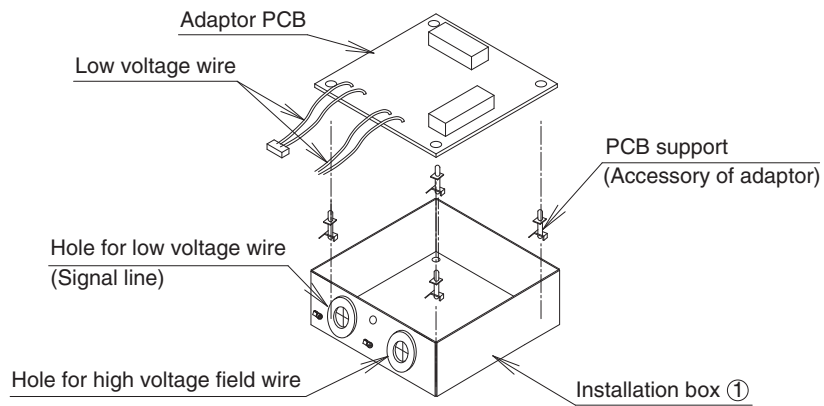

Attach the lid of installation box

Attach the lid of installation box ② to indoor unit with two screws. If two adaptors are installed, the second adaptor is attached to side of first one.

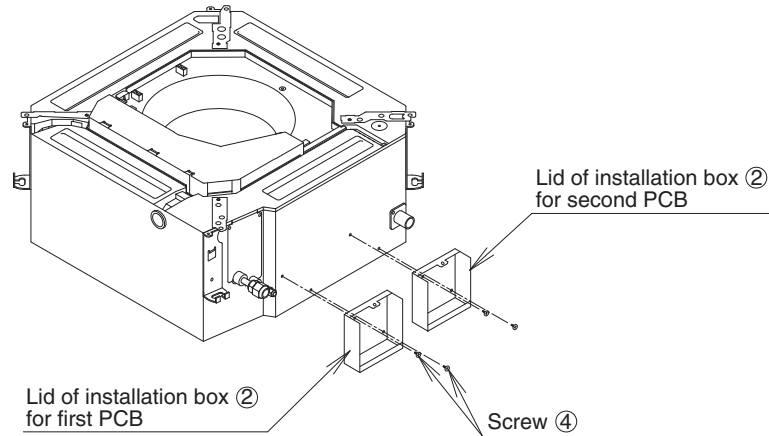

Attach the installation box

Attach the installation box ① into the lid of installation box ② with the screw.

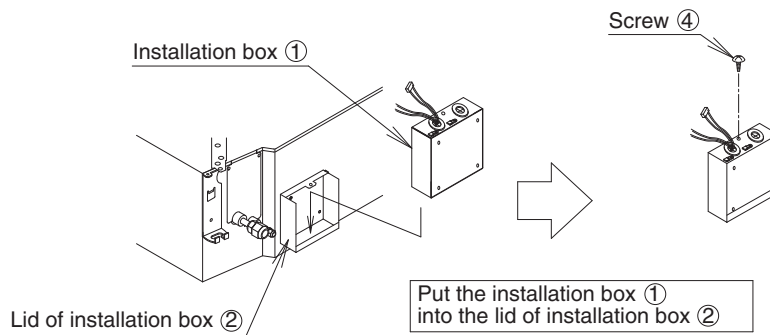

② Method of wiring processing

- Connect wires with the control box. (Refer to the installation manual attached to the adaptor.)
- After connecting wires with the control box, clamp wires by using the cord stickers ⑤ and the clamp ③ as shown in the below drawing.

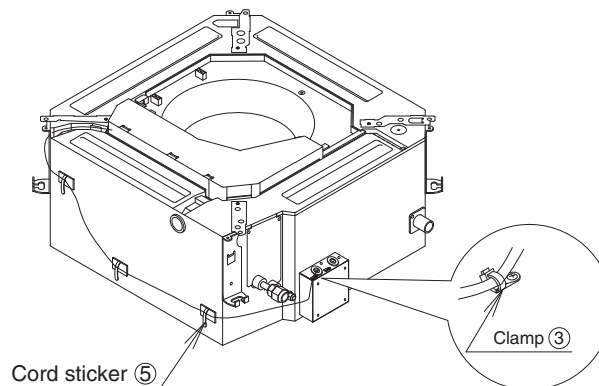





2.16 <KRCS01-4B> Remote Sensor

Notes

- Please check applicable kit model name by catalog etc.
- When installed on SkyAir Round-flow type models, the dehumidification by detection of humidity does not operate.

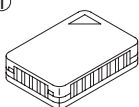
Accessories

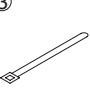
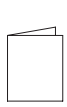
Check the following accessories.

Name	Remote sensor (sensor box)	Extension cable (2-core, 12m)	Clamp	Installation manual (this drawing)	Mounting screw (M4x16)
Shape	① 	② 	③ 	④ 	⑤ 
Quantity	x 1	x 1	x 2	x 1	x 2

1 Mounting

1) Selection of mounting location.

The thermistor for temperature detection is incorporated into the remote sensor. Select the mounting location taking the following cautions into account.

- ① Where the average temperature of an air conditioned room can be detected.
- ② Where it is not exposed to the direct sunlight.
- ③ Where it is not influenced by other heat sources.
- ④ Where it is not exposed to the direct discharge air from the air conditioner.
- ⑤ Where it is not exposed to the outdoor air infiltrated into the room by opening the door.

2) Mounting

- Remove the cover of the sensor box.

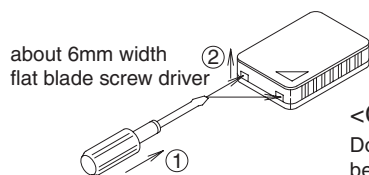

① Insert a flat blade screw driver into the sensor box concave part (2 locations).

② Remove the cover pushing up the nail to the cover of the sensor box.

<Cautions>

Do not push the nail powerfully with a narrow flat blade screw driver, because you may break off the nail.

(a) When mounting on the wall

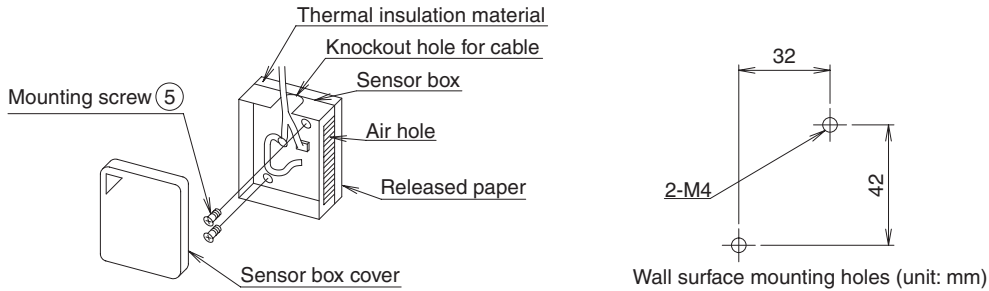

- Break open the knockout hole in the sensor box with a nipper or a similar tool. Pass the extension wires through the hole and fasten the wires to the terminals with screws.
- To avoid tensile force on the terminals, pass the attached clamp through the holes shown in the below right figure and tighten the extension cable with the attached clamp at the sheathed part. (The knot must come to the box inside.)

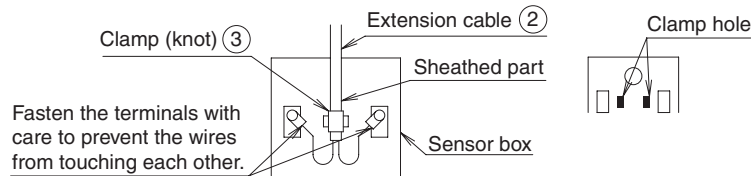

- Screw the sensor box securely to the wall surface with screws M4x16 (2 places).
If the sensor box cannot be screwed to wall surface, tear off the released paper and mount it on the wall surface.

(b) For embedded wiring

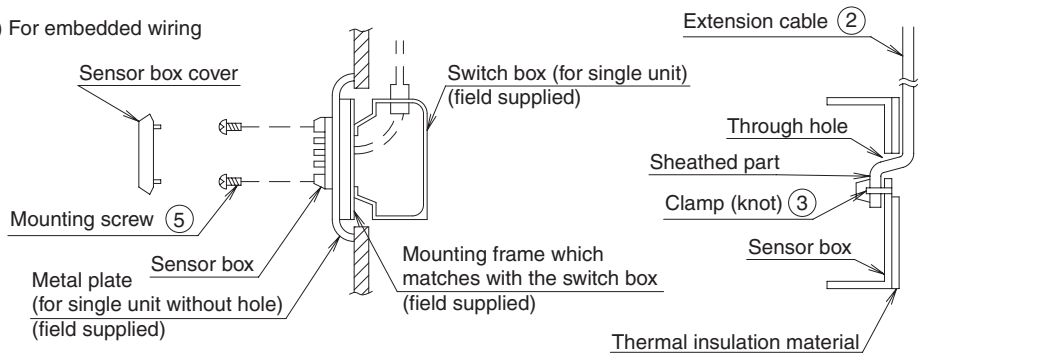

- Pass the extension cable through the switch box cable hole and carry out the wiring.
- Pass the attached clamp through the clamp holes and tighten the extension cable at the sheathed part as shown in the upper right figure.
- Tap M4 screw holes in the metal plate (field supplied) as shown in the right drawing and mount the switch box on the metal plate.

<Cautions>

- When wiring the extension cable, the air holes will not be blocked.
- When the extension cable is longer than necessary, cut it to the appropriate length, peel the insulation, attach the round crimp terminal for M3 (field supplied) and carry out the wiring. The length of insulation to be peeled off is as shown. (Work carefully so that the connector side may not be cut.)



2 Wiring method

Connect the extension cable connector side to the indoor unit PCB (printed circuit board)
For connection to the indoor unit, follow the procedure shown below.

⚠ Caution

- 1) Make sure to turn off the power supply before starting the wiring work and do not turn on until all the work is completed.
Read also the installation manual and the wiring diagram of the indoor unit when carrying out the work.
- 2) When wiring the extension cable, do not pass where the extension cable may be affected by the power line or noise.
- 3) Make sure to securely connect the connectors.
Defective connection may result in incorrect detection of room temperature or malfunction.
- 4) Do not splice wires.
- 5) Since the connector marking of the thermistor for detection of inlet air temperature differ depending on the indoor unit type, make sure to check the indoor unit wiring diagram and follow it correctly.
- 6) Lay and clamp the extension cable inside the indoor unit switch box just like the low voltage line (cord for remote controller).
And do not pass where the extension cable inside the indoor unit switch box may be affected by the power line (cord for the indoor unit and the other electric line).

<Procedure>

- 1) When wiring to the indoor unit PCB, remove the existing thermistor (for detection of inlet air temperature) and then connect the extension cable.
When doing this work, make sure to check the symbol of connecting address on the PCB whether it is correct or not referring to the wiring diagram.

<For SkyAir and VRV>

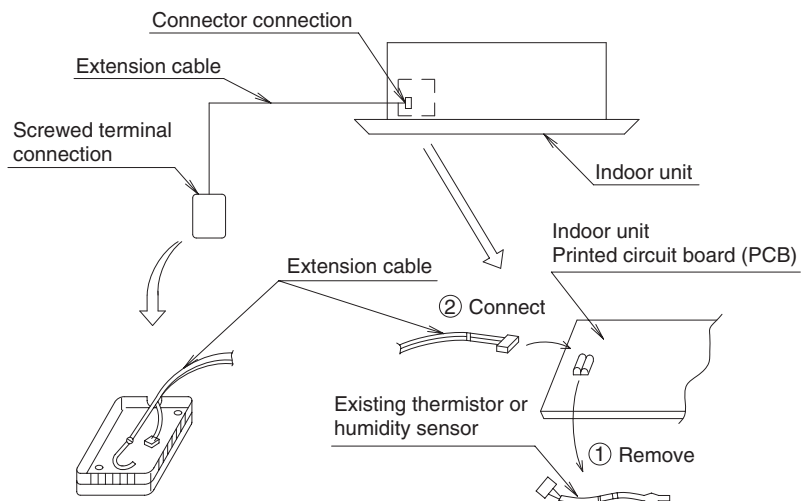

- 2) Lay and clamp the extension cable inside the indoor unit switch box just like the existing thermistor.
When doing this work, keep a certain distance between the high voltage wiring and the low voltage wiring to avoid error of sensor.
Provide protection of the existing cable for thermistor without affecting other components.
- 3) Fit the sensor box cover into the sensor box.

3 Operation test after mounting the sensor

Conduct cooling and heating operation test after the sensor is mounted and the wiring is completed.

3. Indoor Unit

3.1 <BRYQ60A2W(S)> Sensor Kit

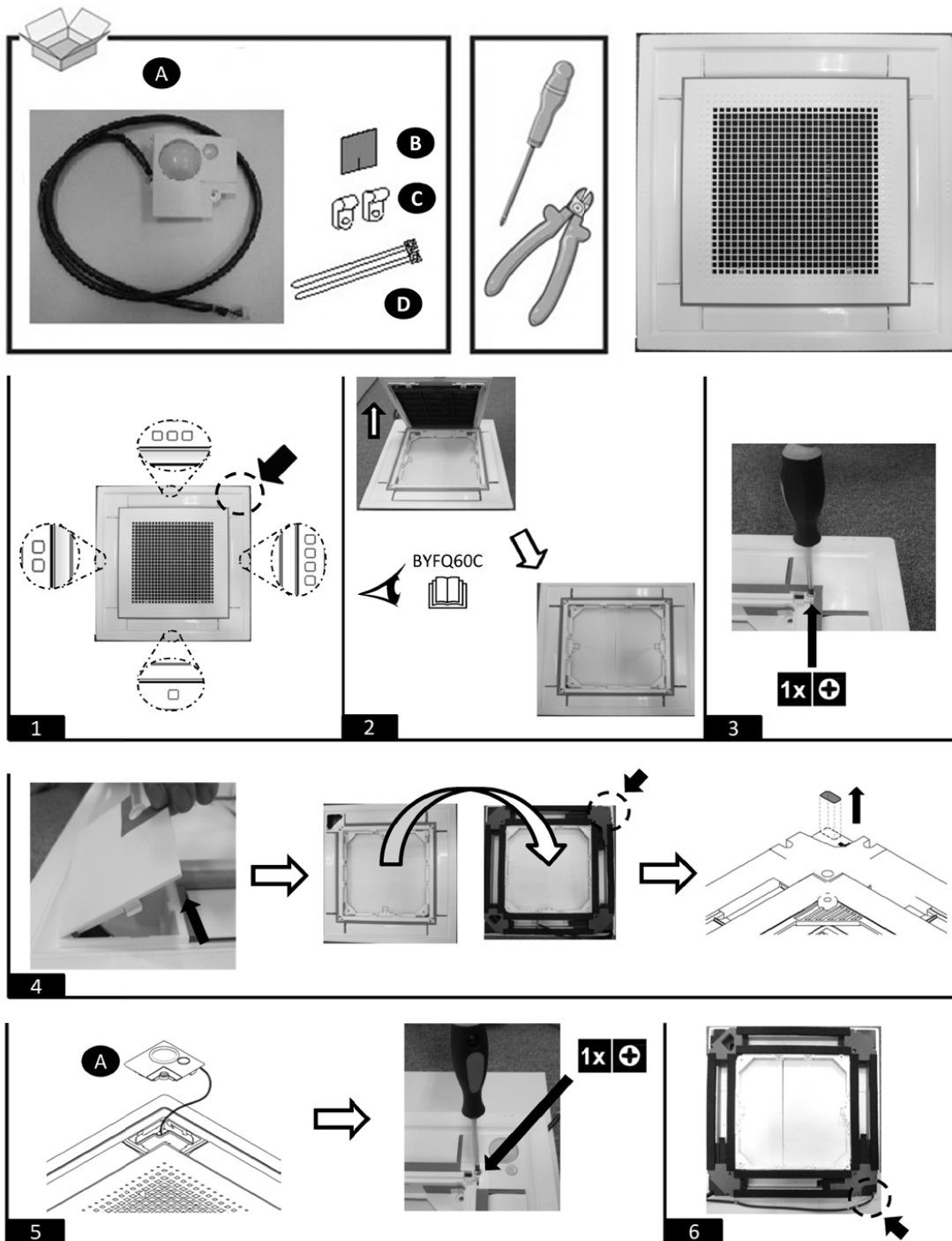

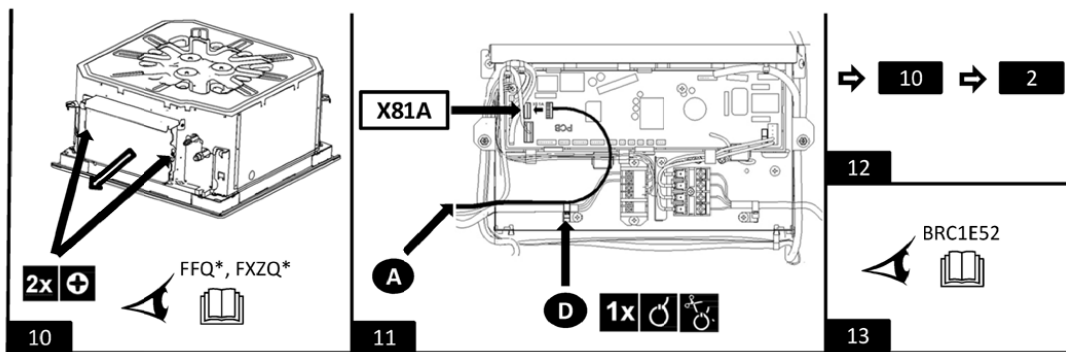
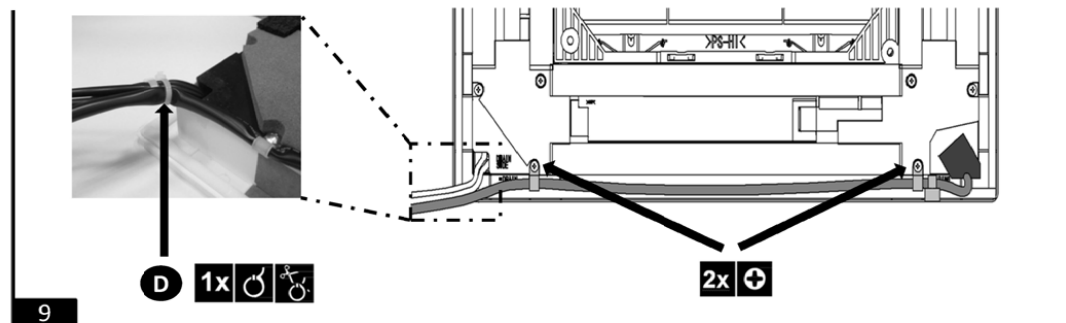
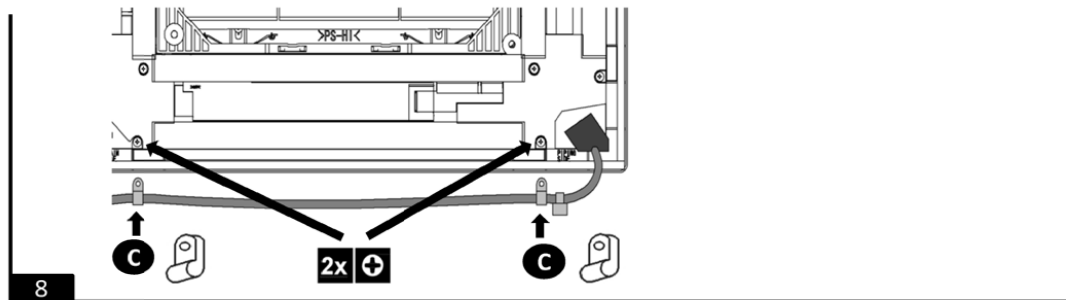
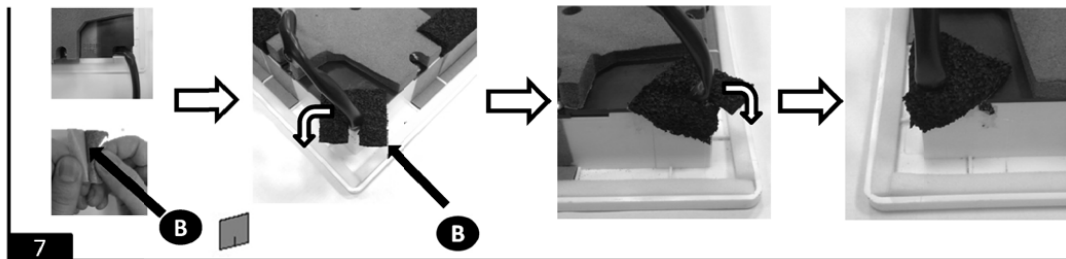





3.2 <KDBQ44BA60A> Panel Spacer



Caution

- When the Panel Spacer is installed, it is not possible to have 2-way air outlet.
- Refer to the installation manual for both indoor unit and the Panel spacer for its installation.

Contents of kit

Check if following parts are included with your kit.

Name	Panel spacer frame	Resin corner part	Fixing metal	Screw
Quantity	4 PCS.	4 PCS.	4 PCS.	28 PCS.
Shape · number	① 	② 	③ 	④  M4 12 Tapping screw (Class 2)

Name	Sealing material	
Quantity	2 PCS.	2 PCS.
Shape · number	⑤ 	⑥ 

1 Preparation of the decoration panel

- Handle the decoration panel with care.

Never place the panel face down, or lean the panel against wall or place on the projective object.
(It causes the dent or damage of the surface of the panel or damage of swing motor.)

- Remove the suction grill from the decoration panel.
(Refer to the installation manual of the decoration panel how to remove.)
- Place the panel face down on the corrugated board or the vinyl sheet to protect the surface of the panel.

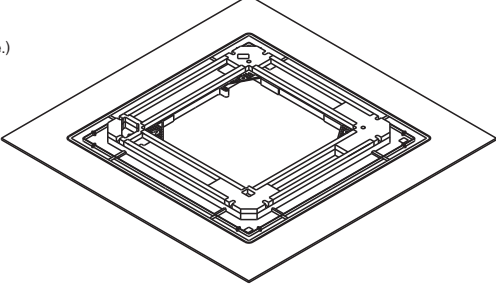

2 Installation of the indoor unit

Adjust the height of the indoor unit.

Be sure the piping will not contact with the ceiling joist etc. after adjusting the height.

Standard installation

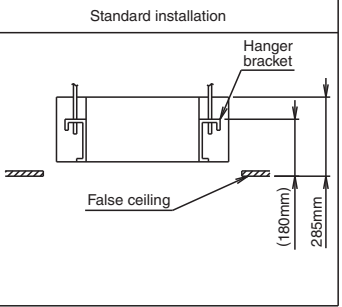

→

When the Panel spacer is installed

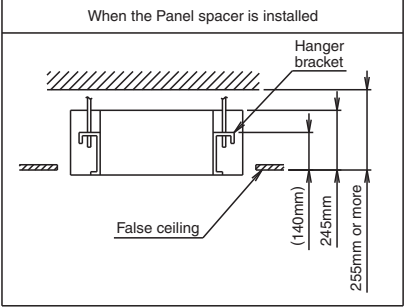

3 Assembly of panel spacer

(1) Assemble the panel spacer frame (1) and the plastic corner joint (2) temporarily.

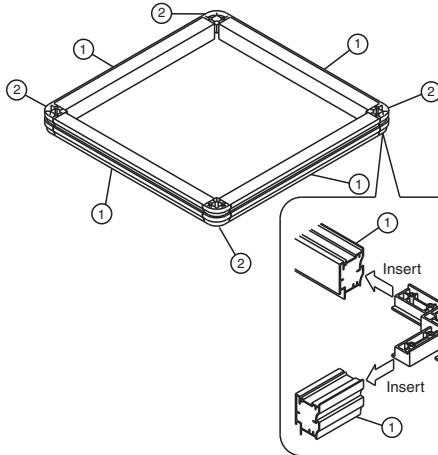

(2) Fix with the screws (4) from the top. (4 screws in each corner)

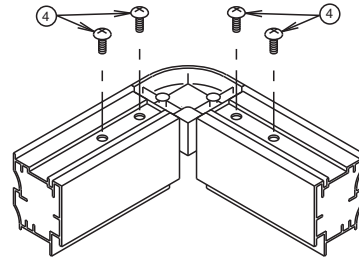

4 Fixing to the decoration panel

(1) Set the fixing metal (3) on each corner with screws (4).

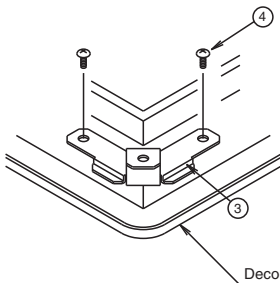

(2) Place the panel spacer assembled in item (3) Assembly of panel spacer (3) on the outer frame of the decoration panel.

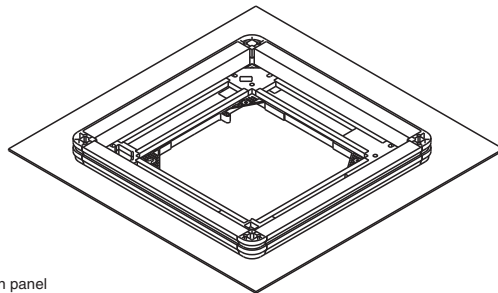

(3) Fix the panel spacer to the fixing metal (3) with screws (4) (4 portions).

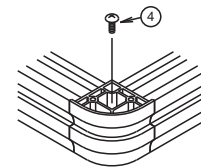

5 Adhesion of the sealing material

Adhere the sealing material (5) (6) on the upper face of the panel spacer in the order of (5) and (6).

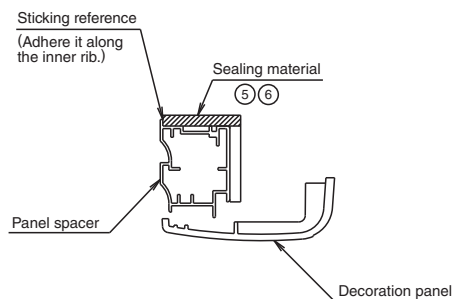
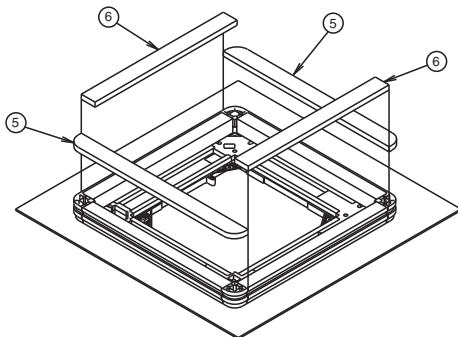

6 Installation of the decoration panel

Install the decoration panel to the indoor unit according to the installation manual of decoration panel.

The panel spacer is not firmly fixed to the decoration panel, so that never hold the panel spacer directly or lean the decoration panel extremely.

3.3 <BDBHQ44C60> Sealing Member

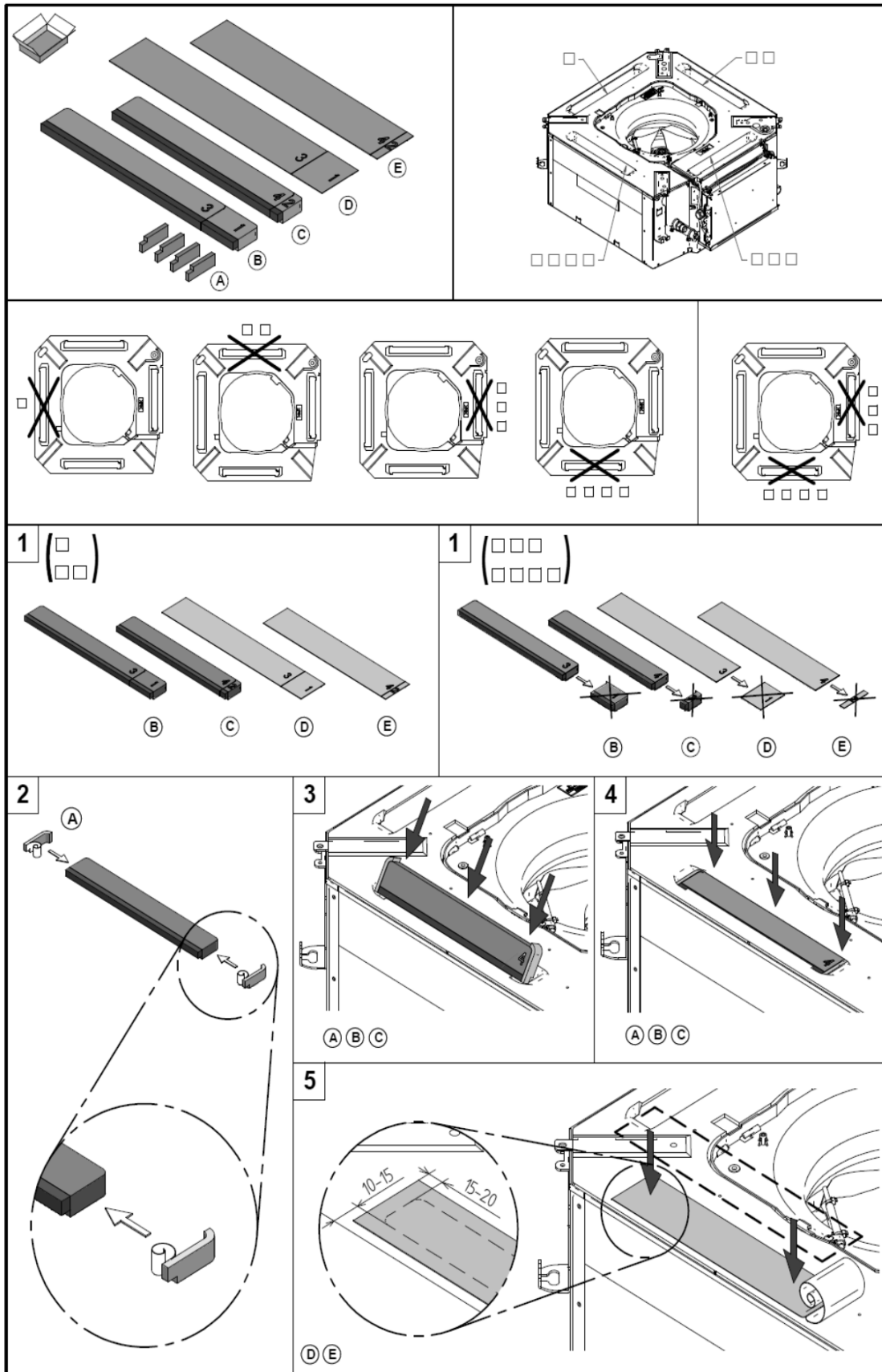

- The 3 different kinds of setting such as "Mode number", "First code number" and "Second code number" must be made by the remote controller.
- The setting and operation procedure are written in the installation manual provided with the remote controller.
- Do not perform settings that are not listed in the table.

Setting according to number of air outlets used

Set the "Second code number". It is shown in the table below depending on the number of air outlet used.

Setting	Mode number (Note)	First code number	Second code number
4-way flow	13(23)	1	01
3-way flow			02
2-way flow			03

3.4 <KDDQ44XA60> Fresh Air Intake Kit





Remarks :

1. This kit can be installed to the Ceiling mounted cassette type (Multi-flow).
2. When installing this kit, duct (Nominal dia. : $\phi 100$) is required on site.

- In case that metal duct is penetrated through wooden walls, make sure the duct and the wall electrically insulated.
- Install the duct inclined downwardly to outdoor so that the rain may not get into the duct. (Inclination 1/100 to 1/50)
- To avoid birds, small animals or insects getting inside the duct, make sure to install net where it contacts the outside air.

Contents

Prior to installation, make sure you have the complete kit of parts.

Name	① Duct flange	② Screws	③ Insulation for duct flange	④ Insulation for opening of unit	⑤ Installation manual
Q'ty	1 piece	4 pieces	1 piece	1 piece	1 piece
Shape		 M4×12			

Necessary tools

Philips head screw driver, nipper, cutter etc.

1 Installation procedures of duct flange

1. Cut off the knockout hole on the side plate. (Fig.1)

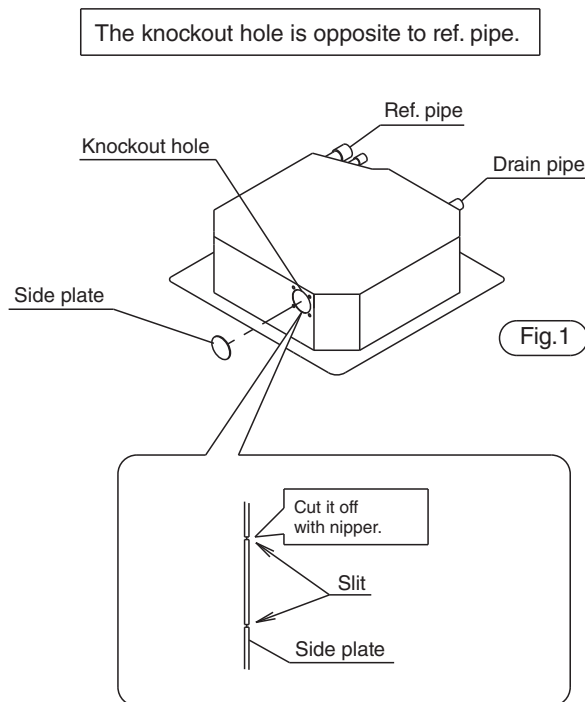

2. Adhere the insulation ④ for opening of unit to the opening. (Fig. 2)

Put the insulation ④ to be suitable for the hole of the insulation ④ and hole of the indoor unit.
However, put the insulation ④ so as not to conceal the screw hole of the indoor unit.

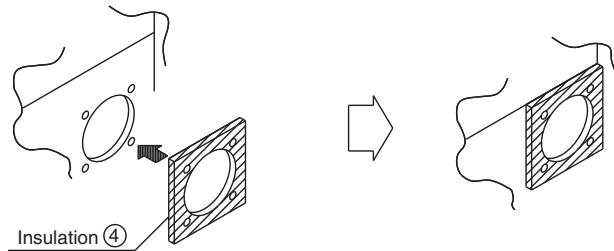

Fig. 2

3. Install the duct flange ① with screws ② (M4x12, 4 screws) to the opening and adhere the insulation ③ (Fig. 3)

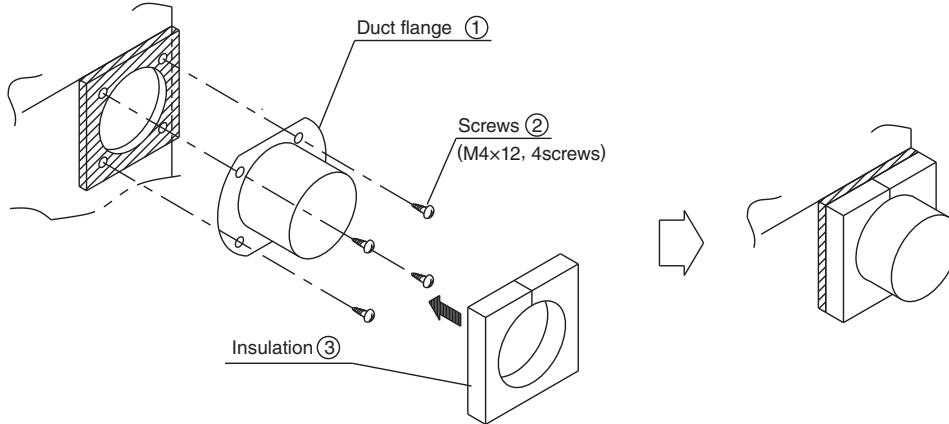

Fig. 3

2 Installation procedures of duct <Nominal diameter of duct : f100>

1. Connect the duct to the duct flange. (Flange fits inside the duct.) (Fig. 4)
2. After connection, wrap vinyl tape (field supply) around the duct connection to prevent air leak.

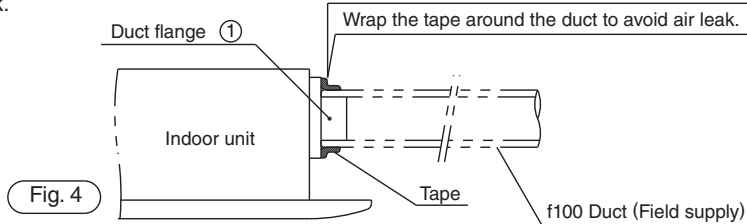

Fig. 4

Precaution

- All ducts must be completely insulated.
- Do not do the followings when installing duct.

- A) To bend the duct excessively B) To bend the duct too many times C) To reduce the duct diameter



WRONG



WRONG

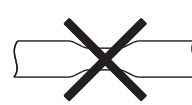





WRONG

4. Outdoor Unit

4.1 <KPW063B4> Air Direction Adjustment Grille

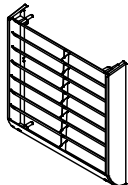
Component parts Be sure to check that the following parts are included before installation.

Component parts

Name	① Air direction adjustment grille	② Screw	③ Spacer	④ Installation Manual
Illustration				
Quantity	1 pcs.	4 pcs.	4 pcs.	1 sheet (this sheet)

Selection of installation site

Install only on an outdoor unit in a location that satisfies the following conditions:

- When installing the outdoor unit near the neighbouring house.
- Where you wish to change the exhaust airflow direction because the outdoor unit has been installed facing a road, so that passing people are not exposed to its exhaust air
- When changing the airflow direction to prevent exhaust blowing directly onto passersby or garden plants.

Cautions for usage

- Be sure to perform the following as installation precautions to ensure correct and safe use of the air direction adjustment grille.
 1. Install the product so that it is situated high enough to allow access to the outdoor unit for maintenance purposes.
 2. When installing the product in a location in which it may be exposed to strong winds, install a rollover prevention bracket (sold separately) at the same time.
 3. Tighten screws securely. Failure to do so may result in vibration.

1 Verifying the amount of space required for installation

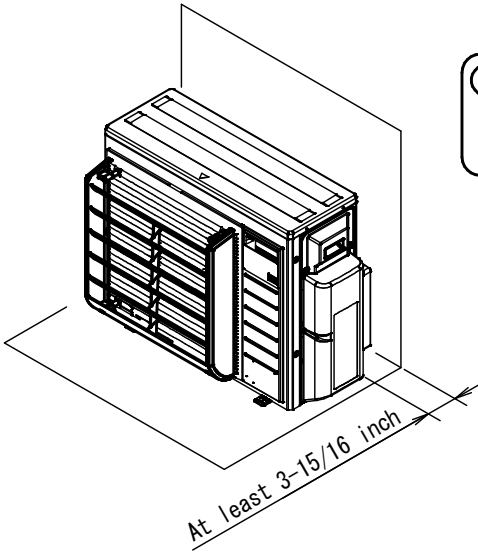

⚠ Caution

Leave at least 3-15/16 inch between the rear of the outdoor unit and any obstructions (walls, etc.).

2 Installation of air direction adjustment grille

⚠ Caution
 Install the air direction adjustment grille on top of the outlet grille.
 Be sure to install the outlet grille as installing only the air direction adjustment grille would allow a person to reach his or her hand into the outdoor unit far enough to come into contact with the rotating fan.

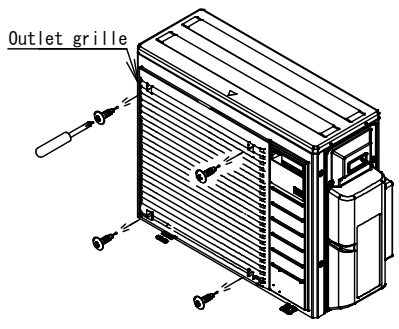

- (1) Remove the 4 outlet grille fixing screws.
- (2) Referring to the following illustration, attach the outlet grille and air direction adjustment grille, taking care to align them with the air outlet direction.
- Attach the air direction adjustment grille on top of the outlet grille using the same screws.

Upward facing

Downward facing

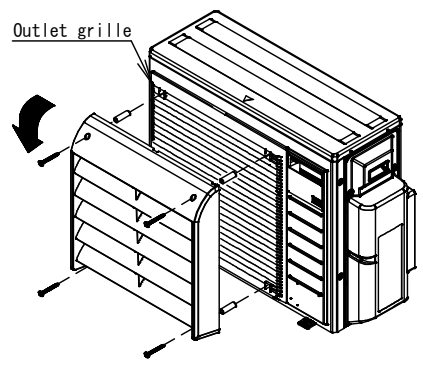
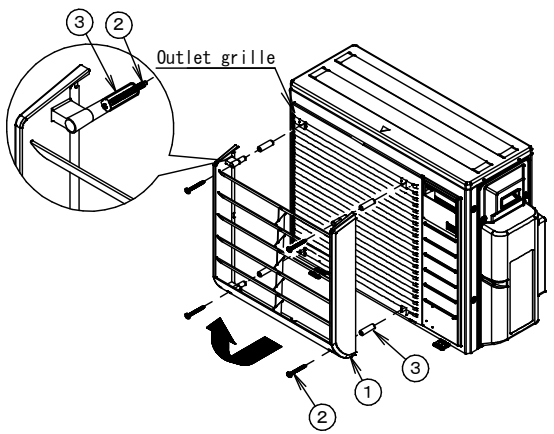

Appearance of the air direction adjustment grille after installation (when installed with the louvers facing up)

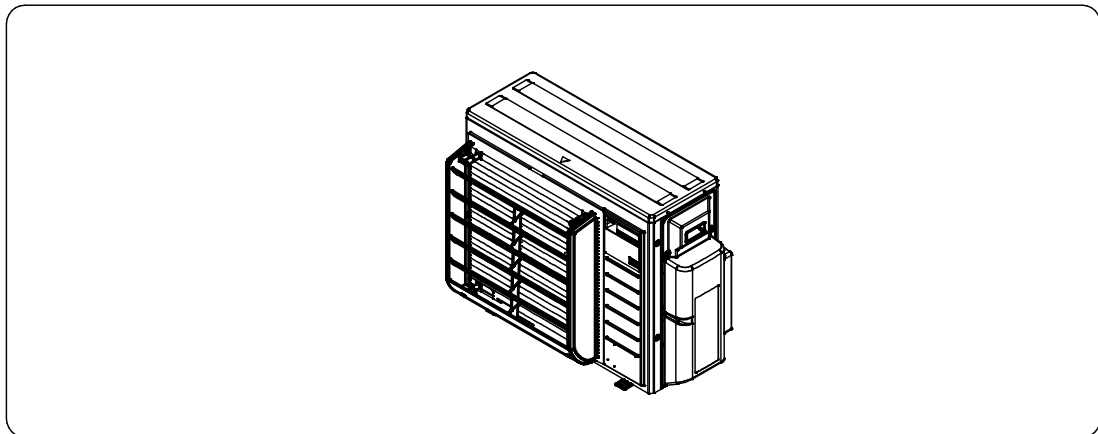

4.2 <KPW082A41> Air Direction Adjustment Grille

Safety Considerations

Give this installation manual to the user when installation is completed.

- Read these **Safety Considerations** carefully to ensure correct installation.
- Meaning of **WARNING** and **CAUTION** symbols:

⚠ WARNING: Indicates a potentially hazardous situation which, if not avoided, could result in death or serious injury.

⚠ CAUTION: Indicates a potentially hazardous situation which, if not avoided, may result in minor or moderate injury. It may also be used to alert against unsafe practices.





⚠ WARNING

- Only qualified personnel must carry out the installation work. Installation must be done in accordance with this installation manual. Improper installation may result in electric shock, fire, or equipment damage.
- Use only specified accessories and parts for installation work. Failure to use specified parts may result in electric shock, fire, the product falling, or equipment damage.

⚠ CAUTION

- Wear protective gloves at the time of installation. Touching the suction mouth or aluminum fins of the outdoor unit may result in injury.

Accessories

(A) Air direction adjustment grille 	1	(B) Spacer 	4
(C) Washer 	4	(D) Screw M5 × 1-3/16" (M5 × 30mm) 	4
(E) Installation manual 	1		

Tools Required for Installation

- Phillips screwdriver

Installation Procedure

⚠ WARNING

- Be sure to check that the power supply of the product is turned off.

Use when the outdoor unit is installed in a location which meets any of the following conditions.

- When installing near the border to a neighbor's house.
- If exhaust blows directly on passers-by because outdoor unit is installed facing a road.
- Changing the fan direction of the outdoor unit to prevent it blowing directly on shrubbery, etc.

1. Temporarily assemble the air direction adjustment grille.

- 1) Attach the (B) spacers and (C) washers to the (A) air direction adjustment grille, then fix with the (D) screws (4 locations).
 - Depending on the installation, 4 outlet directions are possible (up, down, left and right). Refer to the illustration for screw fixing locations.

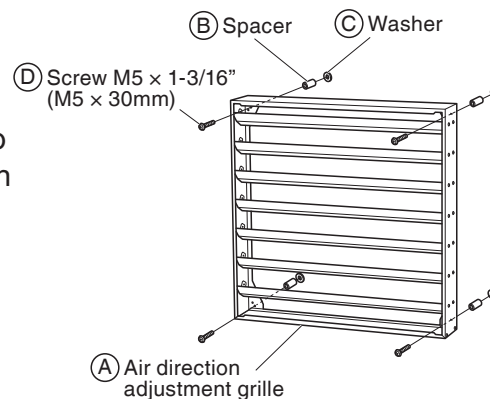

Screw fixing position

- In the case of up or down outlet

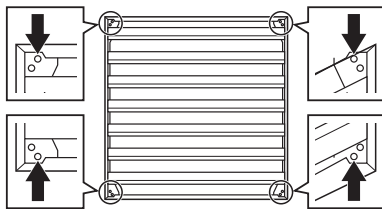

- In the case of left or right outlet

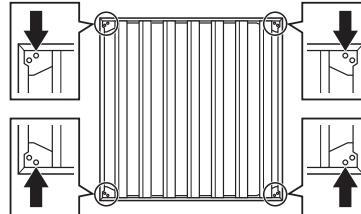

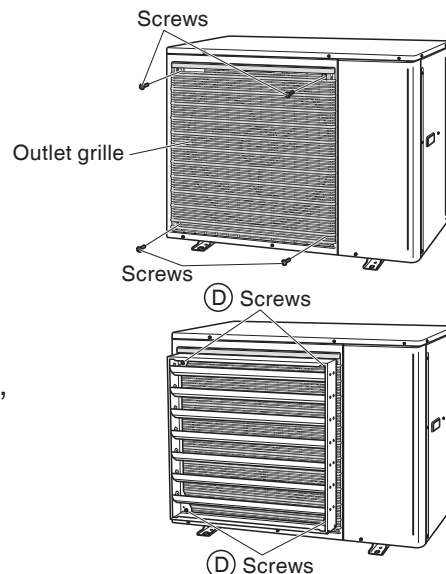

2. Attach the (A) air direction adjustment grille to the outdoor unit.

- 1) Remove the outlet grille screws from the outdoor unit (4 locations).
 - Do not detach the outlet grille.
 - Be careful not to drop the outlet grille.
- 2) Attach the (A) air direction adjustment grille which was temporarily assembled in **step 1**, then tighten and secure with the (D) screws (4 locations).



4.3 <KKG063A42> Back Protection Wire Net

Component parts

Name	① Protection net	② Installation manual
Shape		
Q'ty	1pc.	1sheet (this sheet)

Caution

Be sure to wear protection gloves when performing installation work as the fins on the heat exchanger may cause injury.

Part names

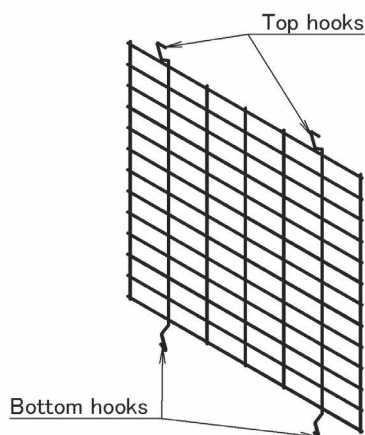

2 Attach the protection net (①)

Orient the protection net (①) so that top and bottom hooks are facing the heat exchanger and insert the two bottom hooks between the heat exchanger and the bottom frame.

Insert the two top hooks between the heat exchanger and the top panel while flexing the protection net (①).

※ Be careful not to damage the heat exchanger's cooling tubes.

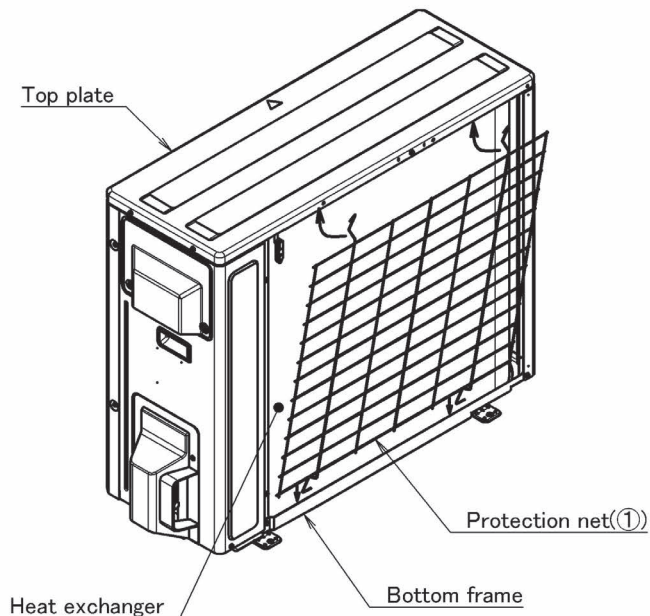

1 Verify the location at which the protection net (①) is to be installed.

Attach the protection net (①) so that the vertical grating is aligned with the edge of the installation leg on the right side of the outdoor unit.

Positioning line when installing the protection net (①)

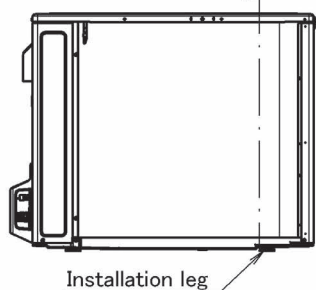

3 Appearance of the protection net (①) following installation

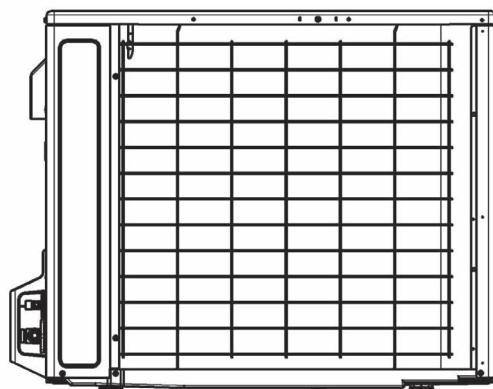

4.4 <KKG082A41> Back Protection Wire Net

Safety Considerations

Give this installation manual to the user when installation is completed.

- Read these **Safety Considerations** carefully to ensure correct installation.
- Meaning of **WARNING** and **CAUTION** symbols:

WARNING: Indicates a potentially hazardous situation which, if not avoided, could result in death or serious injury.

CAUTION: Indicates a potentially hazardous situation which, if not avoided, may result in minor or moderate injury. It may also be used to alert against unsafe practices.



WARNING

- Only qualified personnel must carry out the installation work. Installation must be done in accordance with this installation manual. Improper installation may result in electric shock, fire, or equipment damage.
- Use only specified accessories and parts for installation work. Failure to use specified parts may result in electric shock, fire, the product falling, or equipment damage.

CAUTION

- Wear protective gloves at the time of installation. Touching the suction mouth or aluminum fins of the outdoor unit may result in injury.

Accessories

(A) Protection net 	1	(B) Screw M5 × 1/2" (M5 × 12mm) 	6
(C) Installation manual 	1		

Tools Required for Installation

- Phillips screwdriver

Installation Procedure

1. Remove the 3 screws that hold the heat exchanger.

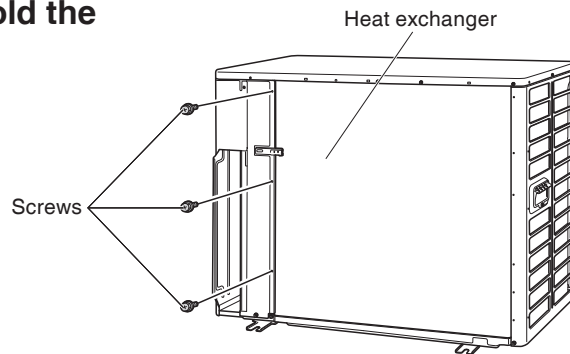

2. Attach the (A) protection net.

Orient the (A) protection net so that the top and bottom hooks are facing the heat exchanger and insert the 2 bottom hooks between the heat exchanger and the bottom frame.

Insert the 2 top hooks between the heat exchanger and the top plate while flexing the (A) protection net.

- Be careful not to damage the heat exchanger's cooling tubes.

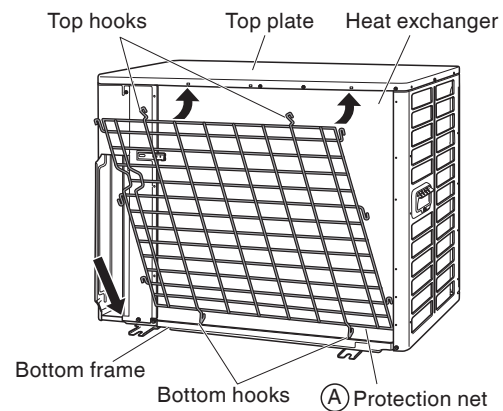

3. Secure the (A) protection net with the (B) screws (6 locations).

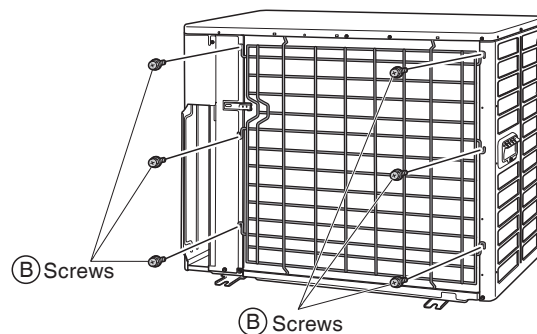

4.5 <BKP082A41> Drain Plug

Safety Considerations

Give this installation manual to the user when installation is completed.

- Read these **Safety Considerations** carefully to ensure correct installation.
- Meaning of **WARNING** and **CAUTION** symbols:

⚠ WARNING: Indicates a potentially hazardous situation which, if not avoided, could result in death or serious injury.

⚠ CAUTION: Indicates a potentially hazardous situation which, if not avoided, may result in minor or moderate injury. It may also be used to alert against unsafe practices.





⚠ WARNING

- Only qualified personnel must carry out the installation work. Installation must be done in accordance with this installation manual. Improper installation may result in electric shock, fire, or equipment damage.
- Use only specified accessories and parts for installation work. Failure to use specified parts may result in electric shock, fire, the product falling, or equipment damage.

⚠ CAUTION

- Wear protective gloves at the time of installation. Touching the suction mouth or aluminum fins of the outdoor unit may result in injury.

Accessories

<p>Ⓐ Drain plug</p> 	<p>9</p>	<p>Ⓑ Drain socket</p> 	<p>1</p>
<p>Ⓒ Drain socket cap</p> 	<p>1</p>	<p>Ⓓ Installation manual</p> 	<p>1</p>

Installation Procedure

- If the outdoor unit drain hole is hidden by an installation platform or the surface of the floor, create a space of 3-15/16 inch (100mm) or more under the legs of the outdoor unit.
- Do not use in cold areas, because in severe cold, the drain water may freeze inside the bottom frame of the outdoor unit and drainage may become difficult.
- If there is any debris or dirt adhered to the areas around the attachment locations, wipe it away with a cloth. If debris or dirt is adhered, water leakage may result.

1. Attach the (A) drain plugs (9 pieces).

- 1) Insert the (A) drain plug into the bottom frame until it is flush with the bottom frame around the entire circumference, as shown in area A.

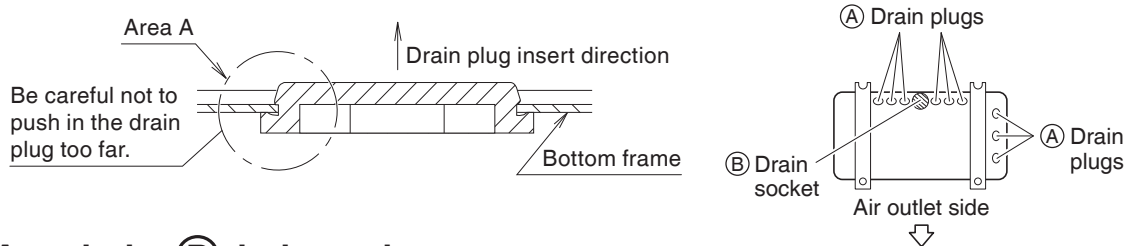

2. Attach the (B) drain socket.

- 1) Attach the (C) drain socket cap to the (B) drain socket.
 - Make sure the (C) drain socket cap is inserted firmly above area B. If not inserted, water leakage may result.
 - Make sure the (C) drain socket cap is not caught on the hooks or other places.
- 2) Insert into area C, the bottom frame drain hole of the outdoor unit, and turn about 40° to the right.

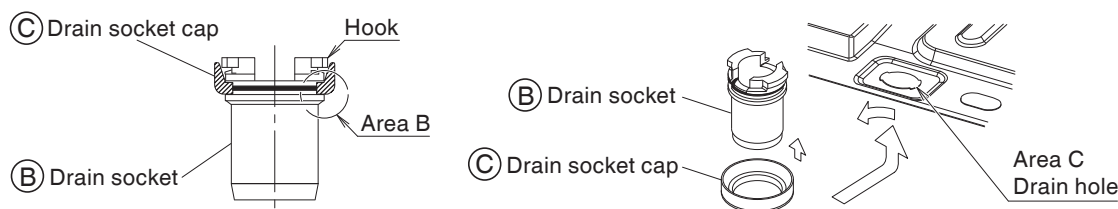

3. Using clamp metal (field supply) connect drain hose (field supply: inner diameter 1 inch (25mm)) to the (B) drain socket.

- Ensure there are no bends in the hose if it is too long or hangs down.

4. After installation, make sure the (A) drain plugs and the (B) drain socket of the outdoor unit are securely inserted and there is no leakage.

4.6 <KEH063A4E> Drain Pan Heater

SAFETY CONSIDERATIONS

Read these **Safety Considerations** carefully before installing the drain pan heater. After completing the installation, check if the unit operates properly during the start-up operation.

Meaning of **DANGER**, **WARNING**, and **CAUTION** symbols



Indicates an imminently hazardous situation which, if not avoided, will result in death or serious injury.



Indicates a potentially hazardous situation which, if not avoided, could result in death or serious injury.



Indicates a potentially hazardous situation which, if not avoided, may result in minor or moderate injury. It may also be used to alert against unsafe practices.

- Inform users that they should store this installation manual for future reference.
- After completing the installation, make sure that the unit operates properly during the startup operation.
- All phases of the field-installation, including, but not limited to, electrical, piping, and safety, must be done in accordance with manufacturer's instructions and must comply with national, state, provincial, and local codes.
- This product is a heater designed to melt snow that is blown into the product from the outside to prevent the drain pan of the outdoor unit from freezing.
- Install the product with a snow-break hood on a high stand if this product is used in heavy snow areas.



WARNING

Only personnel that have been trained to install, adjust, service or repair (hereinafter, "service") the equipment specified in this manual should service the equipment. The manufacturer will not be responsible for any injury or property damage arising from improper service or service procedures. If you service this unit, you assume responsibility for any injury or property damage which may result. In addition, in jurisdictions that require one or more licenses to service the equipment specified in this manual, only licensed personnel should service the equipment. Improper installation, adjustment, servicing or repair of the equipment specified in this manual, or attempting to install, adjust, service or repair the equipment specified in this manual without proper training may result in product damage, property damage, personal injury or death.



DANGER

Do not touch the heater unit without wearing gloves. The temperature of the heater unit will become high when the heater is turned on. Touching the heater unit with bare hands will result in burns or injury.



WARNING







- Wear protective gloves at the time of installation. Touching the suction mouth or aluminum fin of the outdoor unit may result in injury.
- Do not install the product in places where there is danger of exposure to inflammable gas leakage. If the gas leaks and builds up around the unit, it may catch fire.
- Do not grab the top plate of the outdoor unit carelessly when removing the top plate. The sharp edge of the top plate may cause injury.
- Do not install the outdoor unit in places where small animals may nest in the outdoor unit. If small animals intrude and touch the internal parts of the outdoor unit, the outdoor unit may malfunction, generate smoke, or ignite. Advise the user to keep the place clean.
- Do not touch the heater unit with bare hands. The temperature of the heater unit will become high when the heater is turned on. Touching the heater unit with bare hands may result in burns or injury.

 **WARNING**

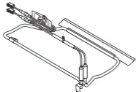
- **REQUEST THE DEALER OR AN AUTHORIZED TECHNICIAN TO INSTALL THE PRODUCT.**
IMPROPER INSTALLATION OF THE PRODUCT COULD RESULT IN WATER LEAKAGE, AN ELECTRIC SHOCK, OR FIRE.
- **THE PRODUCT MUST BE INSTALLED ACCORDING TO THE INSTRUCTIONS GIVEN IN THIS MANUAL.**
THE INCOMPLETE INSTALLATION OF THE PRODUCT COULD RESULT IN WATER LEAKAGE, AN ELECTRIC SHOCK, OR FIRE.
- **USE THE SUPPLIED OR SPECIFIED INSTALLATION PARTS.**
USE OF OTHER PARTS COULD RESULT IN THE UNIT BECOMING LOOSE AND FALLING, WATER LEAKAGE, ELECTRIC SHOCK, OR FIRE.
- **TURN OFF THE POWER SUPPLY AT THE TIME OF INSTALLATION.**
TOUCHING ANY ELECTRICAL PARTS WITH THE POWER SUPPLY TURNED ON COULD RESULT IN ELECTRIC SHOCK.
- **USE SPECIFIED WIRES. CONNECT AND FIX THE WIRES SO THAT THE WIRES WILL NOT PUT IMPROPER FORCE ON THE TERMINAL JUNCTIONS.**
WIRES CONNECTED OR FIXED IMPROPERLY COULD RESULT IN TERMINAL OVERHEATING, AN ELECTRIC SHOCK, OR FIRE.
- **WHEN WIRING AND CONNECTING THE INDOOR AND OUTDOOR UNITS, CAREFULLY ARRANGE THE WIRING SO THAT THEY WILL NOT PUT IMPROPER FORCE ON THE STRUCTURES.**
INSTALL COVERS OVER THE WIRES. INCOMPLETE COVER INSTALLATION COULD RESULT IN TERMINAL OVERHEATING, AN ELECTRIC SHOCK, OR FIRE.

ACCESSORIES

Read these **Safety Considerations** carefully before installing the drain pan heater. After completing the installation, check if the unit operates properly during the start-up operation.

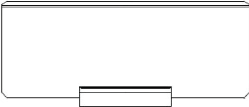
		KEH067A41E(A) FTDBHMS	KEH063A4E FTDBHML	KEH063A4EA
(A) Drain Pan Heater		1	1	1
(B) M4 piercing screw		3	6	6
(C) Binding band		1	1	1
(D) Sealing Material		1	2	2
(E) Installation Manual (multi-language)		1	1	1
(F) Electric Wiring Diagram Label		1	1	1
(G) Information Label		1	1	1
(H) Alternate Mounting Plate		0	0	3

TOOLS REQUIRED

- Electric Drill
- $\phi 1/8$ inch ($\phi 3.2$ mm) drill
- Phillips Screwdriver
- Nippers

INSTALLATION PROCEDURE



WARNING

BE SURE TO CHECK THAT THE POWER SUPPLY OF THE PRODUCT IS TURNED OFF.

Some stages in the installation procedure differ by model of the outdoor unit. Refer to the instructions for the relevant model.

TYPE A MODELS: RX09/12NMVJU, RX09/12AXVJU, RXN09/12, RXL09/12

TYPE B MODELS: RX18/24NMVJU, RXN18/24, RXL15

TYPE C MODELS: 2/3/4MXS, 2/3MXL

TYPE D MODELS: RX18/24AXVJU

TYPE E MODELS: RX09/12RMVJU9A, RXL09/12QMVJU(9)A

1. REMOVE EACH COMPONENT OF THE OUTDOOR UNIT.

1. Remove the top plate.
2. Affix the (F) electric wiring diagram label where there is enough space available on the back of the top plate.
3. Remove the screws from the protective wire mesh if one is fitted. (2 screws)
(For type B and C models only)
4. Remove the front plate.
5. Remove the anti-drip cover.
(For type B and C models only)
6. Affix the (G) information label near the manufacture's label.
 - The appearance of the outdoor unit and the number of screws may differ from some models.
 - Screw types for each component are indicated as below.

No Icon: Hexagon tapping screw

△ : Truss head tapping screw

FOR TYPE A AND D MODELS

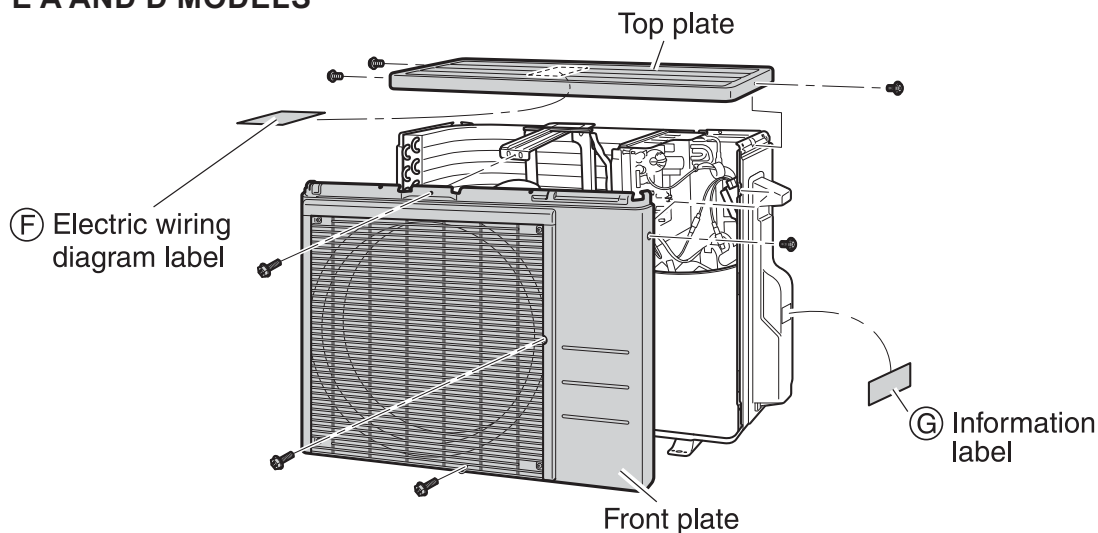

FOR TYPE B AND C MODELS

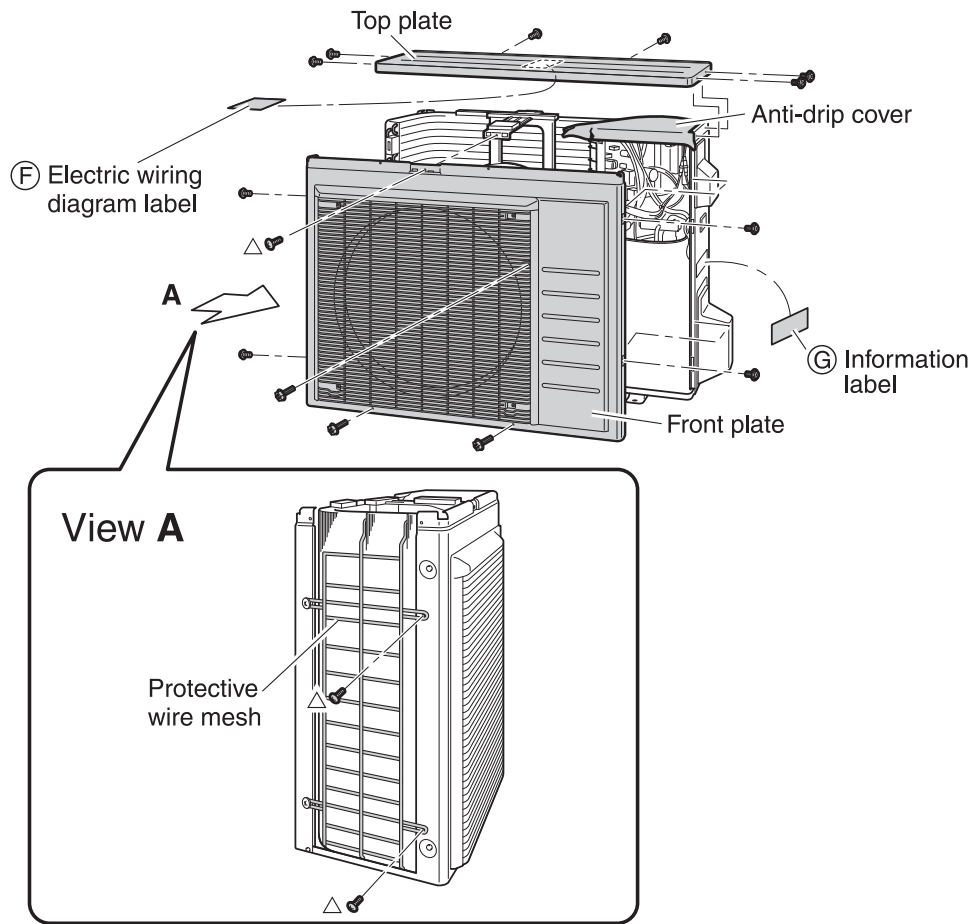

FOR TYPE E MODELS

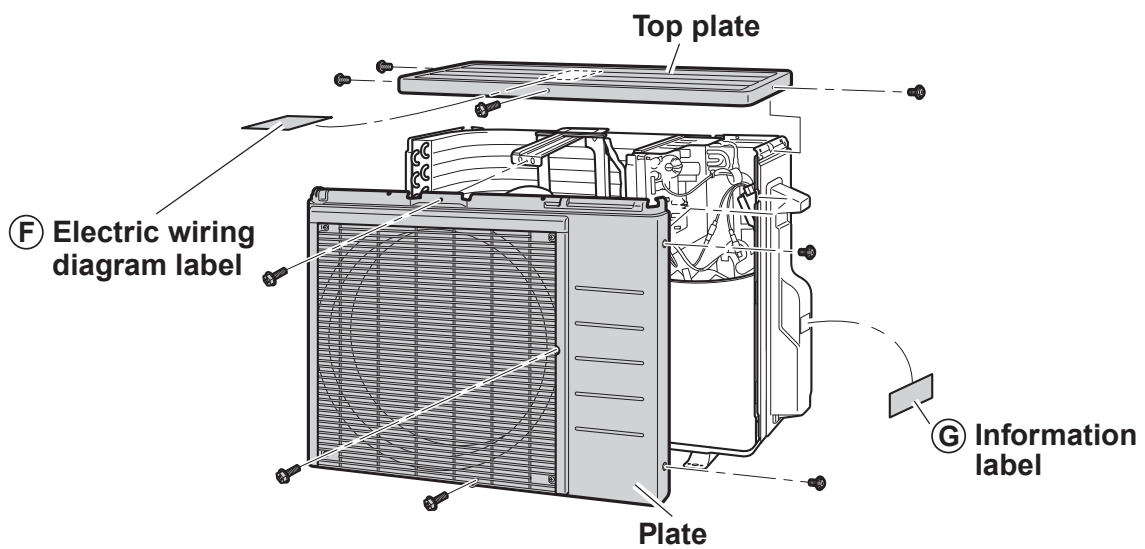

2. REMOVE THE FAN MOTOR BASE.

1. Remove the fixing screws at the lower section of the fan motor base. (2 screws)
2. Remove the fan motor base together with the propeller fan and ensure that stress is not placed on the propeller fan when placing them aside.
 - Do not remove the fan motor harness.
 - Ensure that the fan motor harness does not come into contact with the edges of the heat exchanger or other components.

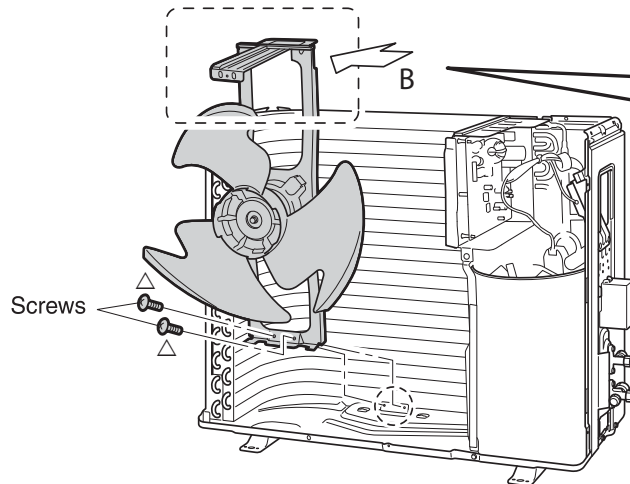

View B

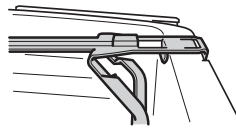

The lugs of the fan motor base are hooked on the heat exchanger.

Appearance of the outdoor unit may differ from some models.

△: Truss head tapping screw

3. INSTALL THE DRAIN PAN HEATER.



CAUTION

WHEN DRILLING A HOLE, BE CAREFUL NOT TO DAMAGE THE SOUNDPROOFING MATERIAL AND OTHER COMPONENTS ON THE BACK SIDE.

1. For type D models, exchange the pre-mounted mounting plates for 2 of the (H) alternate mounting plates as indicated below:

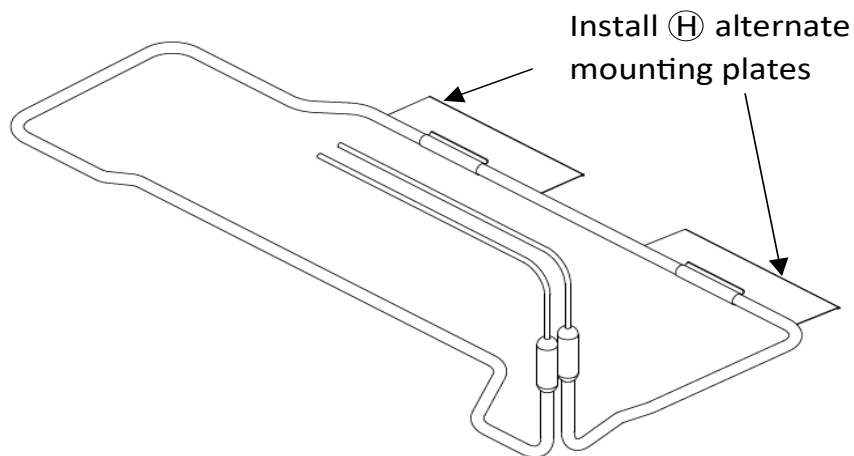
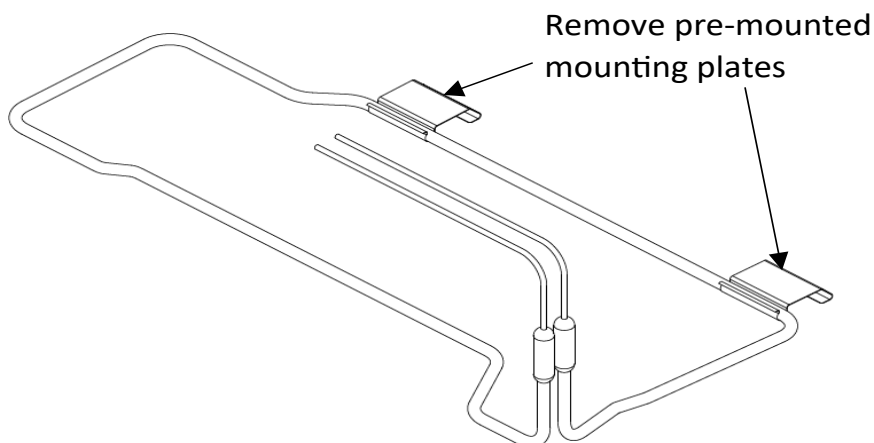

2. Remove 1 screw from the bottom frame (and 1 screw from the left frame for type D models) so that the plates of the (A) drain pan heater can be inserted under the heat exchanger with ease.
3. Lift up the heat exchanger, and insert the plates of the (A) drain pan heater under the heat exchanger.
 - The ground plate of the (A) drain pan heater should be installed so that, in type A models, it firmly adheres to the bottom frame and, in type B and C models, it firmly adheres to the partition plate.
 - Install the (A) drain pan heater in a position where it does not come into contact with the fan motor base.
4. If there are no holes, drill $\phi 1/8$ inch ($\phi 3.2\text{mm}$) holes in the bottom frame or the partition plate (model type dependent) to fix the (A) drain pan heater.
 - Place the actual components to ensure positioning is correct before drilling holes.
 - The holes can be made with the included piercing-screw as well.
5. Fix the (A) drain pan heater with the (B) piercing screws.
6. Reattach the screw that was removed from the bottom frame (as well as the screw that was removed from the left frame for type D models).

FOR TYPE A AND E MODELS

Location and number of holes
Bottom frame: 2

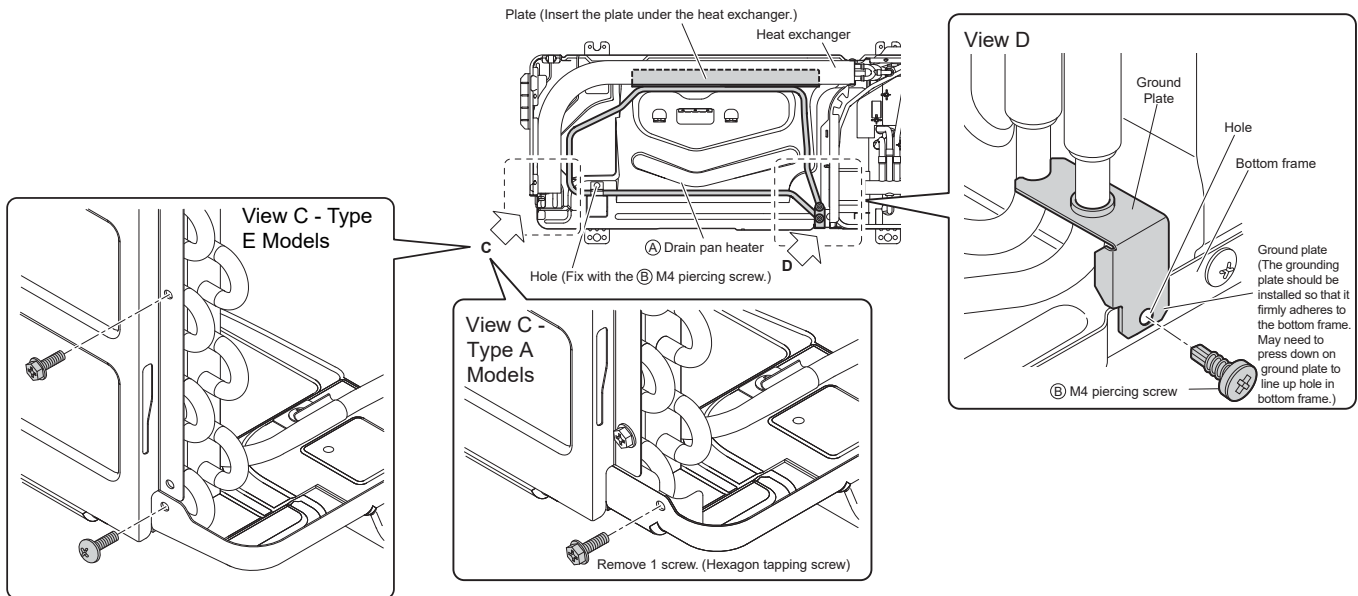

FOR TYPE B, C, AND D MODELS

Location and number of holes
Bottom frame: 1
Partition plate: 2

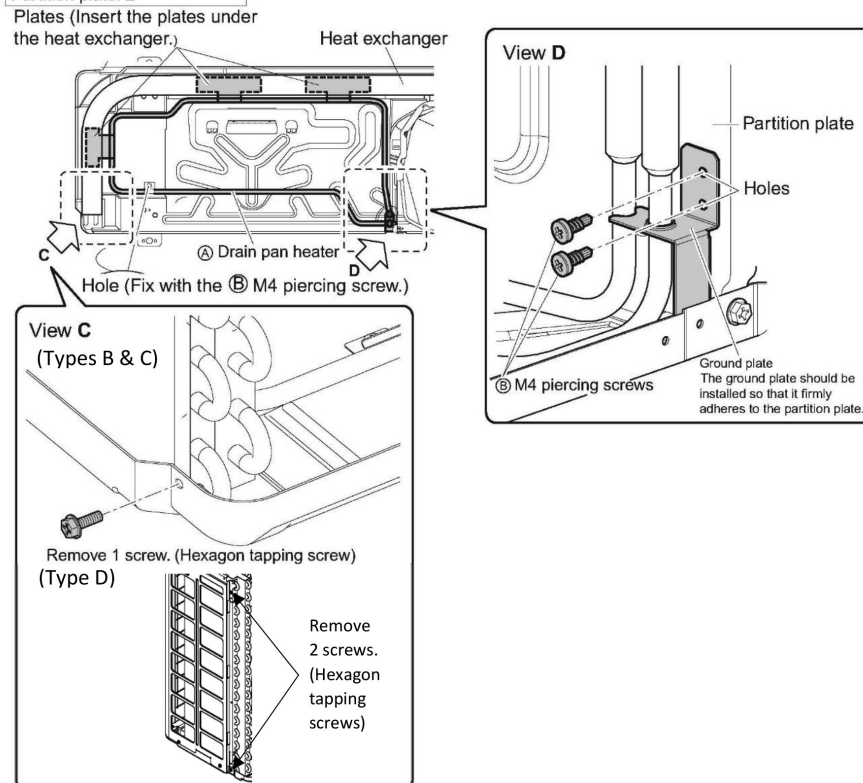

4. ROUTE THE HARNESES.



CAUTION

WHEN DRILLING A HOLE, BE CAREFUL NOT TO DAMAGE THE SOUNDPROOFING MATERIAL AND OTHER COMPONENTS ON THE BACK SIDE.

FOR TYPE A AND E MODELS

1. If there is no hole, drill a $\phi 1/8$ inch ($\phi 3.2\text{mm}$) hole in the partition plate. (1 location)
2. Fix in place the binding band attached to the (A) drain pan heater harness by screwing the (B) M4 piercing screw into the hole. (1 location)
3. Install the fan motor base.
 - Be careful not to confuse screw types. Refer to “Installation Procedure (2)”.
4. Place the (A) drain pan heater harness on top of the fan motor harness, and fix it in place with the (D) sealing material.

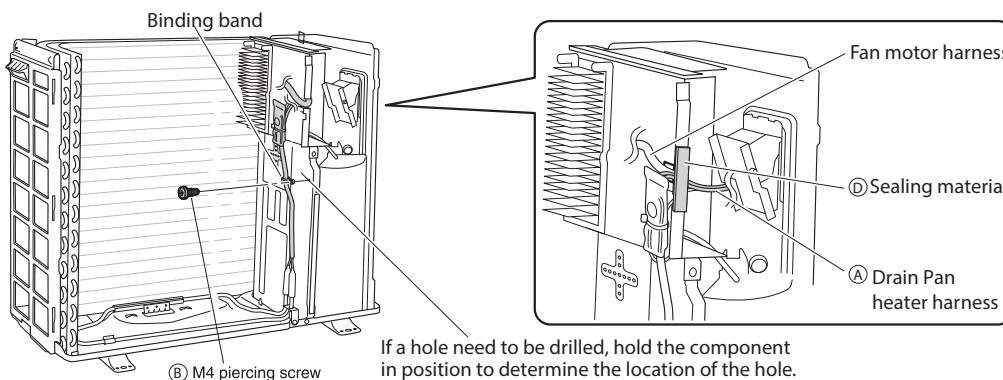

FOR TYPE B, C, AND D MODELS

1. If there is no hole, drill $\phi 1/8$ inch ($\phi 3.2\text{mm}$) holes in the partition plate. (3 locations)
2. Fix the (A) drain pan heater harness in place by screwing the (B) M4 piercing screws into the holes. (3 locations)
3. Install the fan motor base.
 - Be careful not to confuse screw types. Refer to “Installation Procedure (2)”.
4. Trim the electrical wiring box with nippers at the locations shown in the figures, then cover the trimmed edges with the (D) sealing material.
5. Insert the (A) drain pan heater harness into the space that was trimmed, and fix it in place using the (D) sealing material.

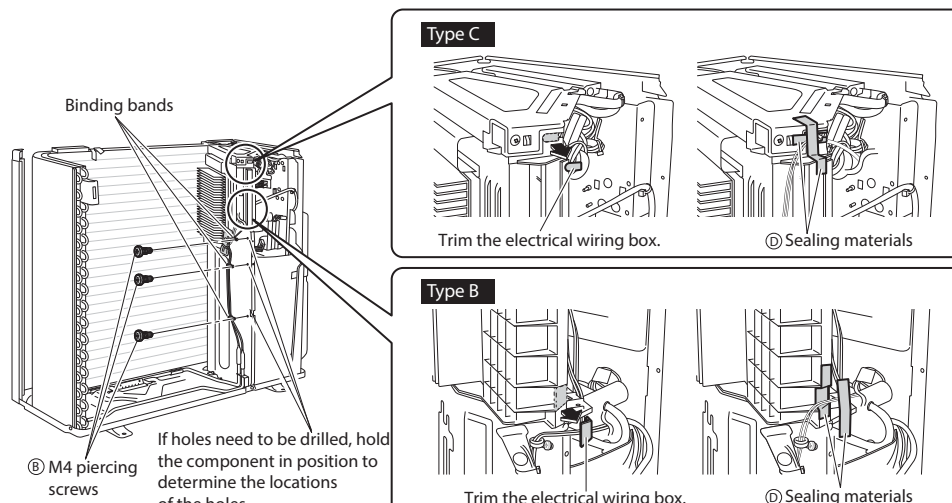

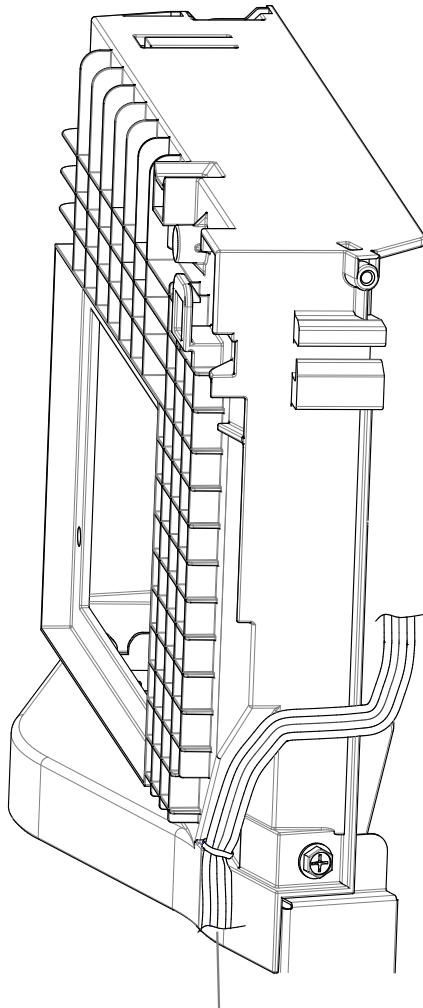
FOR TYPE D MODELS

Route wire as shown

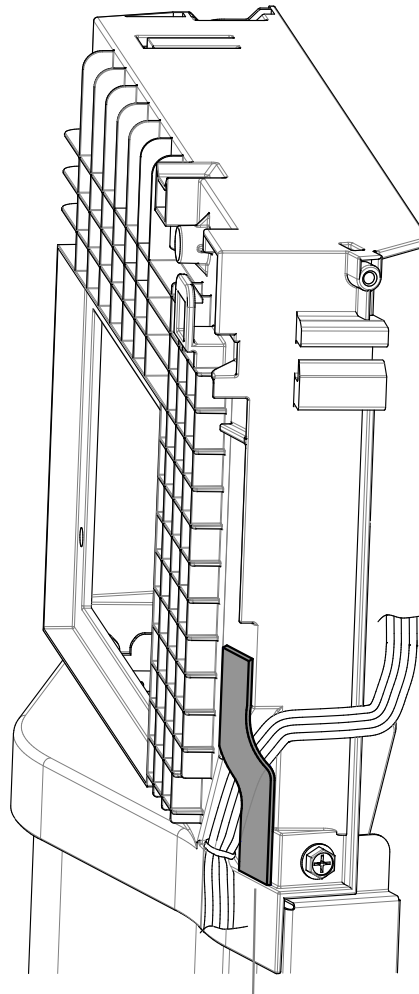

Sealing material

5. CONNECT THE TERMINALS OF THE DRAIN PAN HEATER TO THE TERMINAL BLOCK OF THE OUTDOOR UNIT.

1. Connect the thermostat-side terminal (black harness) to the leftmost terminal and the heater-side terminal (white harness) to the second leftmost terminal.
 - For type C models, connect to the last terminal block of the terminal blocks in use.
2. Bundle the drain pan heater harness so that there is no slack, and secure it with the binding band. (1 location)
 - For type C models, connect to the last terminal block of the terminal blocks in use.

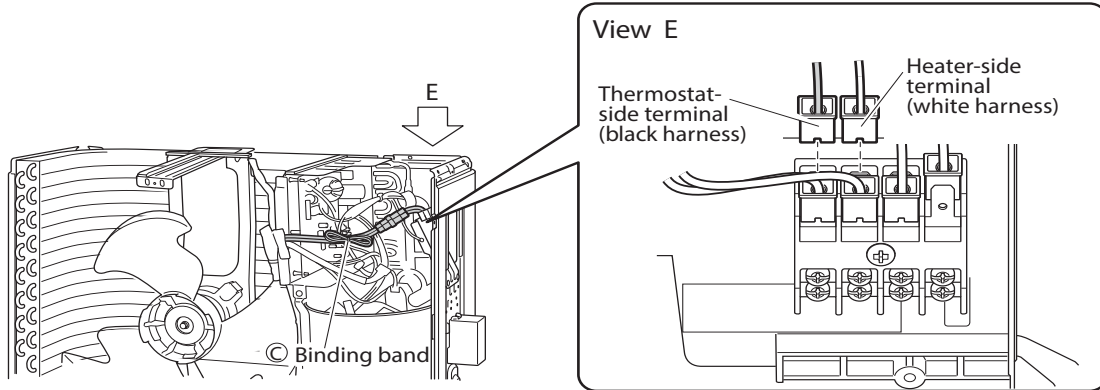
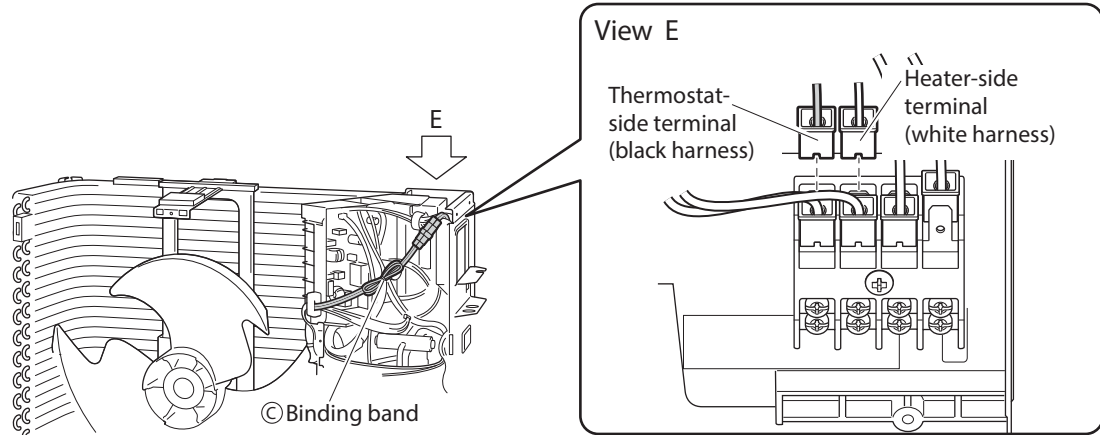
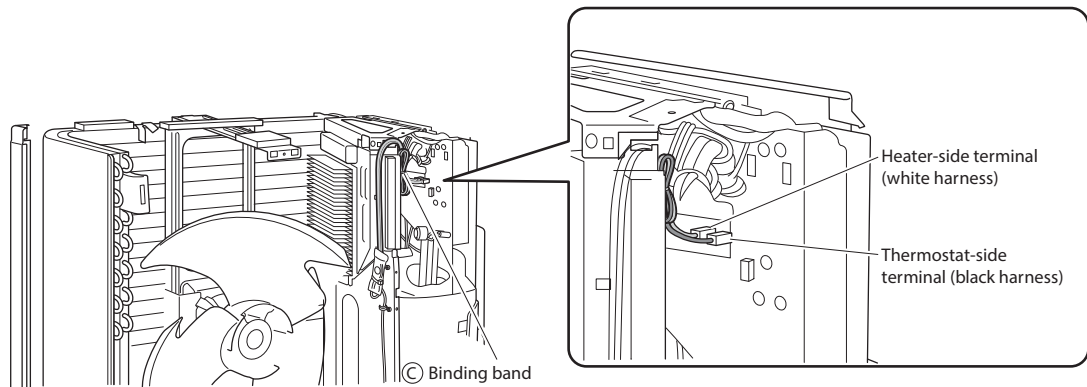
FOR TYPE A AND E MODELS**FOR TYPE B AND D MODELS****FOR TYPE C MODELS****6. INSTALL EACH COMPONENT TO THE ORIGINAL POSITION.**

- Be careful not to confuse screw types. Refer to "Installation Procedure (1)".
- 1. Install the front plate.
- 2. Install the anti-drip cover.
(For type B and C models only)
- 3. Install the top plate.

4.7 <KEH082A41> Drain Pan Heater

Safety Considerations

Give this installation manual to the user when installation is completed.

- Read these **Safety Considerations** carefully to ensure correct installation.
- After completing the installation, make sure that the unit operates properly during the startup operation.
- All phases of the field-installation, including, but not limited to, electrical, piping, and safety, must be done in accordance with manufacturer's instructions and must comply with national, state, provincial, and local codes.
- This product is a heater designed to melt snow that is blown into the product from the outside to prevent the drain pan of the outdoor unit from freezing.
- Install the product with a snow-break hood on a high stand if this product is used in heavy snow areas.
- Meaning of **DANGER**, **WARNING** and **CAUTION** symbols:

⚠ DANGER : Indicates an imminently hazardous situation which, if not avoided, will result in death or serious injury.

⚠ WARNING : Indicates a potentially hazardous situation which, if not avoided, could result in death or serious injury.

⚠ CAUTION : Indicates a potentially hazardous situation which, if not avoided, may result in minor or moderate injury. It may also be used to alert against unsafe practices.

⚠ DANGER

- Do not touch the heater unit without wearing gloves. The temperature of the heater unit will become high when the heater is turned on. Touching the heater unit with bare hands will result in burns or injury.





⚠ WARNING

- Only qualified personnel must carry out the installation work. Installation must be done in accordance with this installation manual. Improper installation may result in electric shock, fire, or equipment damage.
- Use only specified accessories and parts for installation work. Failure to use specified parts may result in electric shock, fire, the product falling, or equipment damage.
- Before touching electrical parts, turn off the unit.
- Use specified wires. Connect and fix the wires so that the wires will not put improper force on the terminal junctions. Wires connected or fixed improperly could result in terminal overheating, an electric shock, or fire.
- When wiring and connecting the indoor and outdoor units, carefully arrange the wiring so that they will not put improper force on the structures. Install covers over the wires. Incomplete cover installation could result in terminal overheating, an electric shock, or fire.

⚠ CAUTION

- Wear protective gloves at the time of installation. Touching the suction mouth or aluminum fin of the outdoor unit may result in injury.
- Do not install the product in places where there is danger of exposure to inflammable gas leakage. If the gas leaks and builds up around the unit, it may catch fire.
- Do not grab the top plate of the outdoor unit carelessly when removing the top plate. The sharp edge of the top plate may cause injury.
- Do not install the outdoor unit in places where small animals may nest in the outdoor unit. If small animals intrude and touch the internal parts of the outdoor unit, the outdoor unit may malfunction, generate smoke, or ignite. Advise the user to keep the place clean.
- Do not touch the heater unit with bare hands. The temperature of the heater unit will become high when the heater is turned on. Touching the heater unit with bare hands may result in burns or injury.

Accessories

(A) Drain pan heater		1	(B) Piercing screw (use for making holes) M4 × 1/2" (M4 × 12mm)		2
(C) Screw M4 × 5/16" (M4 × 8mm)		5	(D) Information label		1
(E) Installation Manual		1			

Tools Required for Installation

- Electric drill
- $\phi 1/8$ inch ($\phi 3.2\text{mm}$) drill
- Phillips screwdriver
- Nippers

Installation Procedure (1)

WARNING

- Be sure to check that the power supply of the product is turned off.

1. Remove each component of the outdoor unit.

- 1) Remove the top plate.
- 2) Remove the right side plate.
- 3) Remove the front plate A.
 - Front plate A is heavy, so be careful.
- 4) Remove the front plate B.
- 5) Remove the shield plate.
- 6) Remove the shield cover.
- 7) Affix the  information label near the manufacturer's label.

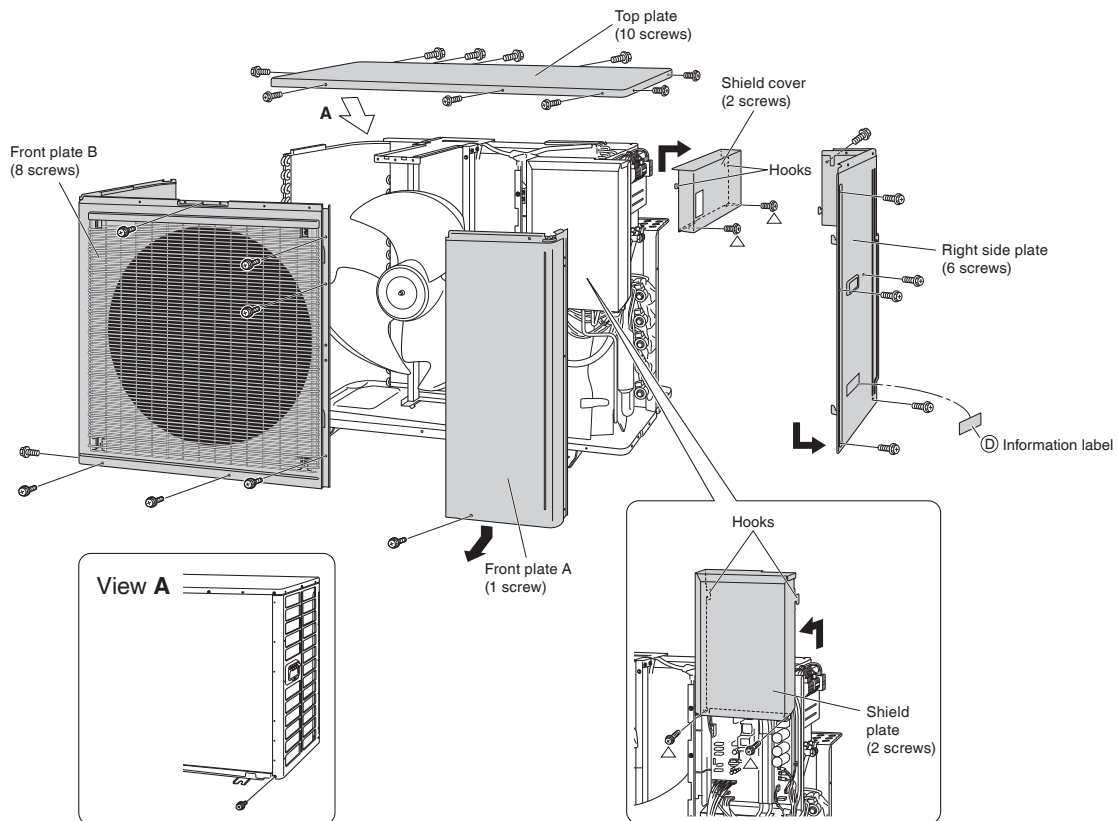

- Screw types for each component are indicated as below.
- No icon: Hexagon tapping screw
-  : Truss head tapping screw

Installation Procedure (2)

2. Install the (A) drain pan heater.

⚠ CAUTION

- When drilling a hole, be careful not to damage the soundproofing material and other components on the back side.

- 1) Insert the plates of the (A) drain pan heater under the heat exchanger.
- 2) If there are no holes, drill $\phi 1/8$ inch ($\phi 3.2$ mm) holes in the bottom frame and the partition plate to fix the (A) drain pan heater.
 - Place the actual components to ensure positioning is correct before drilling holes.
 - The holes can be made with the (B) piercing screw as well.
- 3) After holes are made, fix the (A) drain pan heater with the (C) screws. (Do not fix with the (B) piercing screws.)

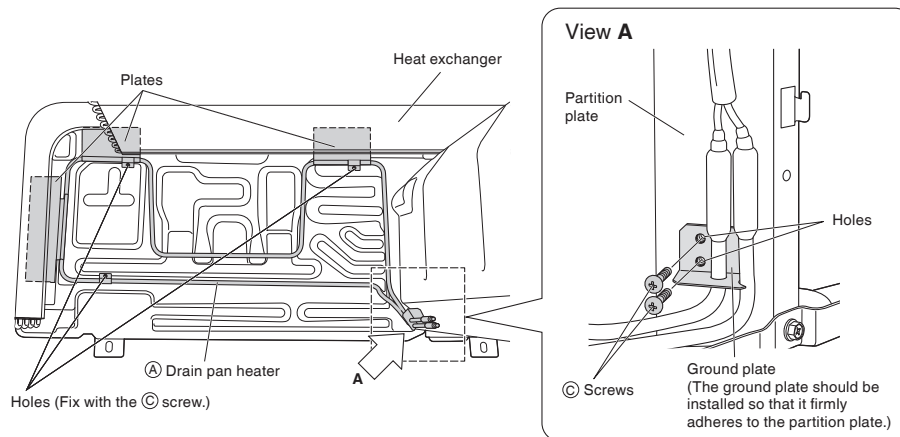

3. Route the harnesses.

- 1) Flex the sheet metal of the outdoor unit and pull the harness around.

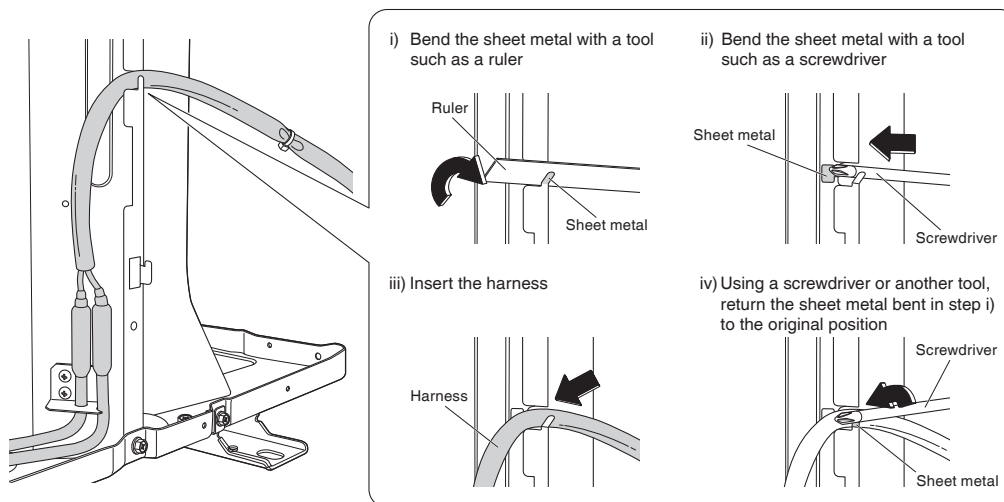

Installation Procedure (3)

- 2) Connect the fasten terminals to DP1 and DP2 on the PC-board.
- Either drain pan heater fasten terminal can be connected to either DP1 or DP2 with no problem.
 - Secure the harness snap band in the hole in the sheet metal.

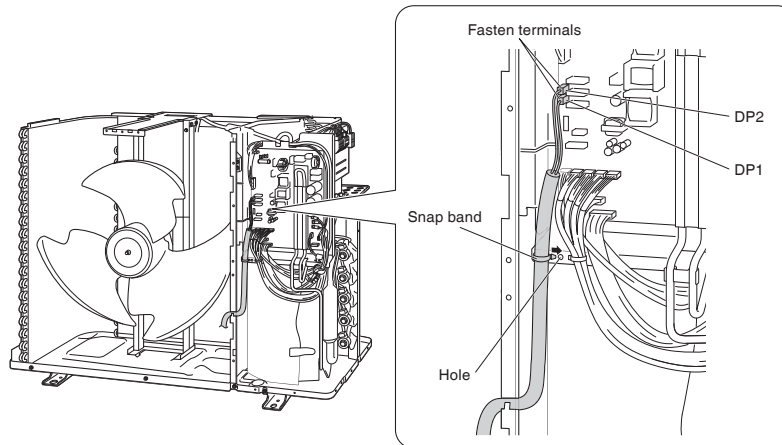

4. Cut the jumper.

- Using a tool such as nippers, cut the jumper (J_DP) on the service PC-board.
- Using the removed truss head tapping screw, reattach the switch cover.

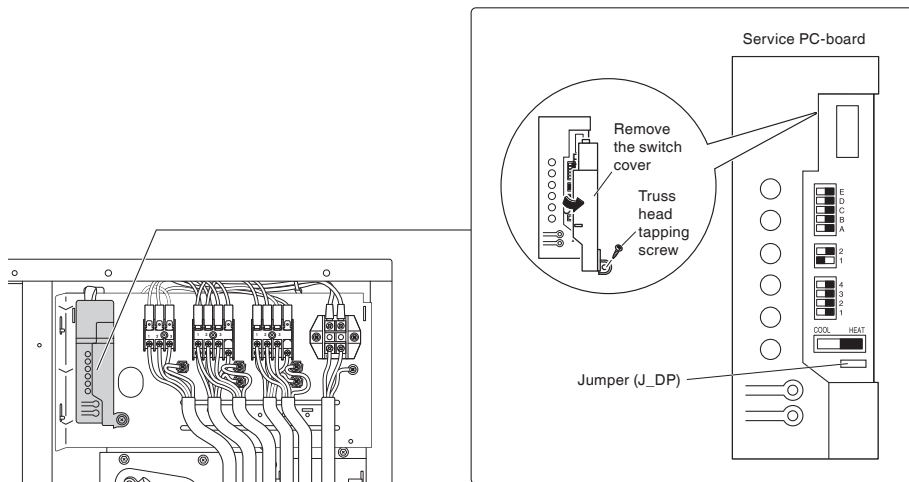





5. Install each component to the original position.

- Be careful not to confuse screw types. Refer to "Installation Procedure (1)".
- Install so that the shield cover and shield plate hooks (2 locations each) are securely engaged.

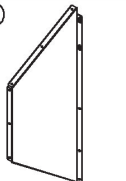
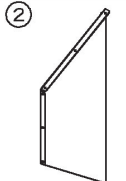
4.8 <KPS063A41> Snow Hood (Side)

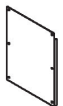
Parts Before assembling the product, verify that all of the following parts have been included:

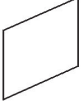
Name	Side plate (right)	Side plate (left)	Top plate	Front plate	Screws	Installation Manual
Illustration	① 	② 	③ 	④ 	⑤  (quantity to use 14)	⑥ 
Quantity	1	1	1	1	16	1 (this document)

⚠ Caution Read these safety considerations for installation carefully before installing the product.

● Be sure to observe the following installation precautions to ensure that the product can be used safely:
 1. Install the product so that it is situated high enough to allow access to the outdoor unit for maintenance.
 2. Installing the product in a location in which it may be exposed to strong winds, secure the outdoor unit with wire or other means.
 3. Choose a location where the operating sound will not cause a nuisance to the neighbors of the user.
 4. Tighten screws securely. Failure to do so may result in vibration.

⚠ Caution
 Indicates a potentially hazardous situation which, if not avoided, may result in minor or moderate injury. It may also be used to alert against unsafe practises.

1 Installing the snow hood (intake side plate)

1 Remove the protective wire mesh

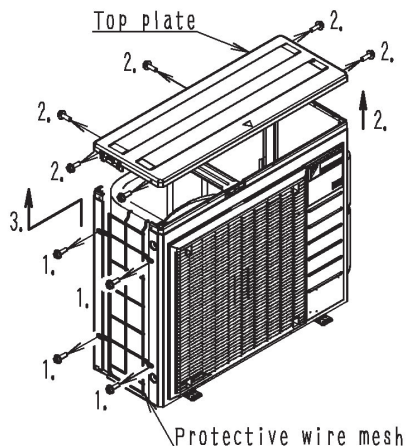

- Remove the 2 screws that hold the protective wire mesh.
- Remove the 6 screws that hold the top plate and remove the top plate.
- Remove the protective wire mesh, being careful of the part that is attached to the heat exchanger.
- Attach the top plate removed in step 2 using the 6 screws removed in step 2.

2 Attach the side plate (right) ①

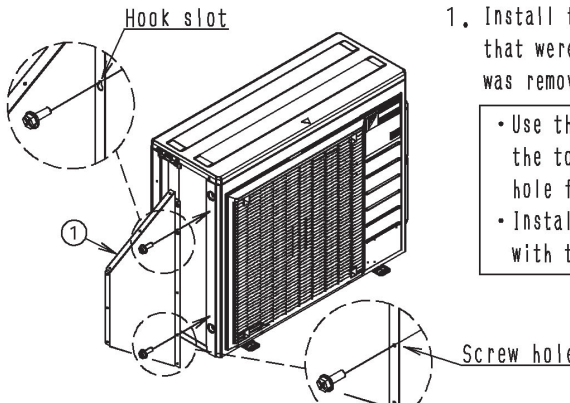

- Install the side plate (right) ① with the 2 screws that were used in the protective wire mesh that was removed in step 1.

- Use the second hook slot from the top and the 2 screw hole from the bottom.
- Installation is easiest if you start with the hook slot.

3 Attach the side plate (left) **2**.

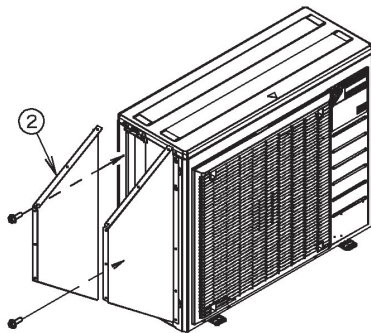

1. Install the side plate (left) **2** with the 2 screws that were used in the protective wire mesh that was removed in step **1**.

- Use the second hook slot from the top and the 2 screw hole from the bottom.
- Installation is easiest if you start with the hook slot.

4 Attach the front plate **4**.

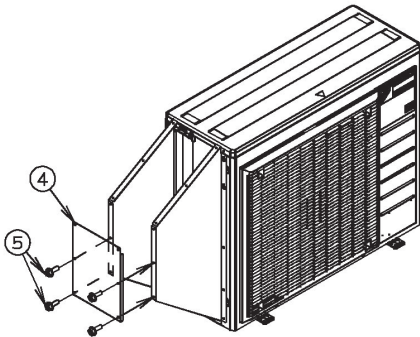

1. Temporarily secure the front plate **4** in place with the 4 screws **5**.

5 Attach the top plate **3**.

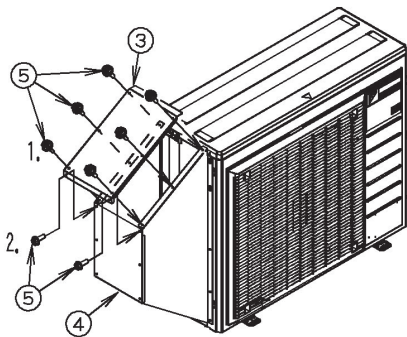

1. Attach the top plate **3** with the 6 screws **5**.
2. Temporarily secure the top plate **3** and the front plate **4** to the side plate (right) **1** and the side plate (left) **2** with the 2 screws **5**.
3. Tighten the 12 screws **5** that you used to temporarily secure parts in steps **4** and **5**.

2 Appearance of the snow hood (intake side plate) after installation

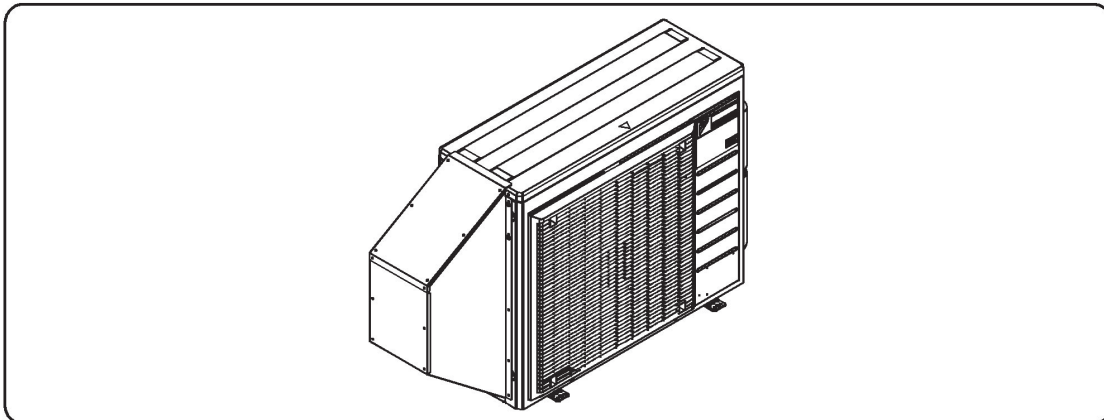

4.9 <KPS063A44> Snow Hood (Rear)

Parts Before assembling the product, verify that all of the following parts have been included:

Name	Side plate (Right)	Side plate (Left)	Top plate	Front plate	Screws	Piercing screw	Installation Manual
Illustration							
Quantity	1	1	1	1	14	3	1 (this document)

⚠ Caution Read these safety considerations for installation carefully before installing the product.

● Be sure to observe the following installation precautions to ensure that the product can be used safely:

1. Install the product so that it is situated high enough to allow access to the outdoor unit for maintenance.
2. Installing the product in a location in which it may be exposed to strong winds, secure the outdoor unit with wire or other means.
3. Choose a location where the operating sound will not cause a nuisance to the neighbors of the user.
4. Tighten screws securely. Failure to do so may result in vibration.

⚠ Caution
Indicates a potentially hazardous situation which, if not avoided, may result in minor or moderate injury. It may also be used to alert against unsafe practises.

1 Installing the snow hood (intake rear plate)

1 Attach the side plate (right) ①.

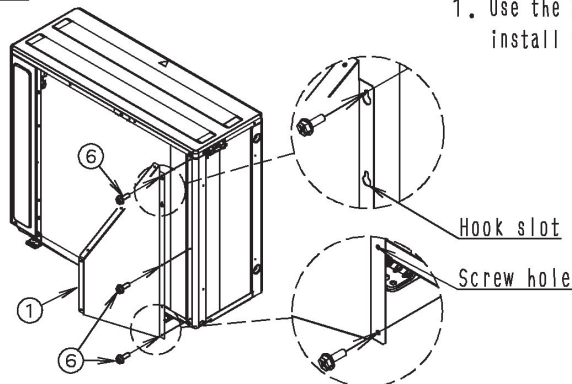

1. Use the 3 piercing screws ⑥ included in the kit to install the side plate (right) ①.

- For the hook slot, use the first hook slot from the top.
- For the screw hole, use the first screw hole from the bottom.
- Installation is easiest if you start with the hook slot.
- Align the screw installation position with the dowel hole.

2 Attach the side plate (left) ②

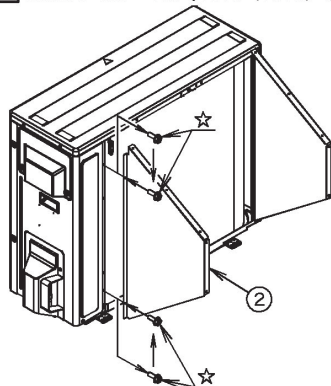

1. Remove the 2 screws (☆) that hold the heat exchanger.
2. Install the side plate (left) ② using the 2 screws removed in step 1.

3 Attach the front plate ④

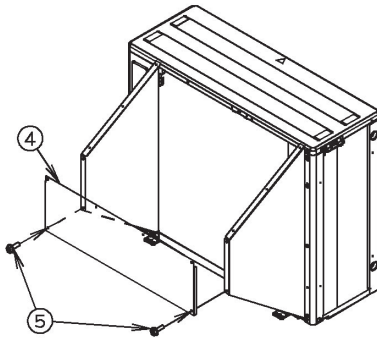

1. Temporarily secure the front plate ④ in place with the 2 screws ⑤ included in the kit.

4 Attach the top plate ③

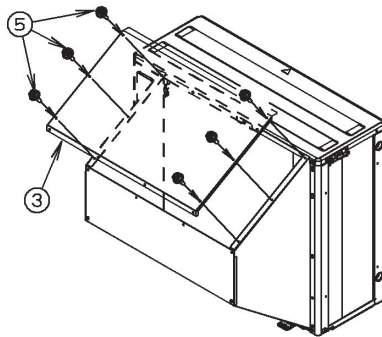

1. Temporarily secure the top plate ③ in place with the 6 screws ⑤ included in the kit.

5 Attach the top plate ③

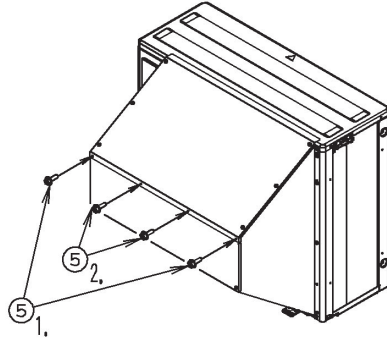

1. Temporarily secure the top plate ③ and front plate ④ to the side plate (right) ① and side plate (left) ② with the 2 screws ⑤ included in the kit.
2. Temporarily secure the top plate ③ to the front plate ④ with the 2 screws ⑤ included in the kit.
3. Tighten the 12 screws that you used to temporarily secure parts in steps 3), 4), and 5).

2 Appearance of the snow hood (intake rear plate) after installation

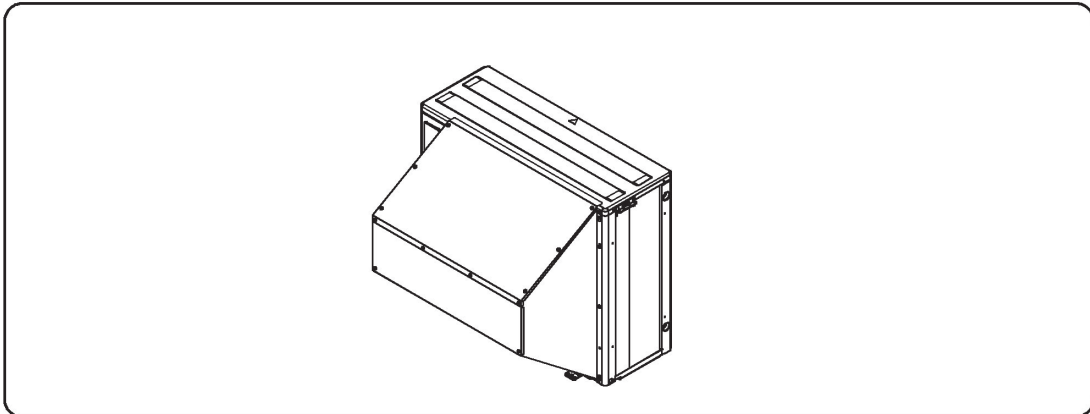

4.10 <KPS063A47> Snow Hood (Discharge)

Parts Before assembling the product, verify that all of the following parts have been included:

Name	Side plate (Right)	Side plate (Left)	Top plate	Installation plate	Screws	Piercing screw	Installation Manual
Illustration							
Quantity	1	1	1	1	8	3	1 (this document)

⚠ Caution Read these safety considerations for installation carefully before installing the product.

● Be sure to observe the following installation precautions to ensure that the product can be used safely:

1. Install the product so that it is situated high enough to allow access to the outdoor unit for maintenance.
2. Installing the product in a location in which it may be exposed to strong winds, secure the outdoor unit with wire or other means.
3. Choose a location where the operating sound will not cause a nuisance to the neighbors of the user.
4. Tighten screws securely. Failure to do so may result in vibration.

⚠ Caution
Indicates a potentially hazardous situation which, if not avoided, may result in minor or moderate injury. It may also be used to alert against unsafe practices.

1 Installing the snow hood (outlet)

1 Remove the discharge grille.

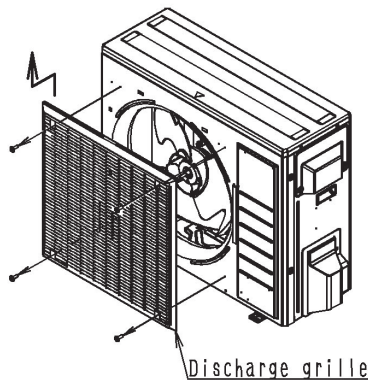

1. Remove the 4 screws that hold the discharge grille. (The discharge grille is held with the 4 screws and 2 hooks.)

2 Attach the side plate (left) ② and installation plate ④.

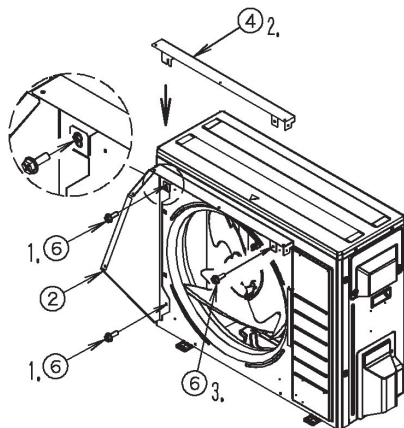

1. Temporarily secure the side plate (left) ② in place with the 2 piercing screw ⑥ included in the kit.
2. Jointly tighten the installation plate ④ with the 1 piercing screw ⑥ temporarily secured in step 1.
3. Install the right side of the installation plate ④ with the 1 piercing screw ⑥.

• Installation is easiest if you start with the hook slot.
• Align the screw installation position with the dowel hole.

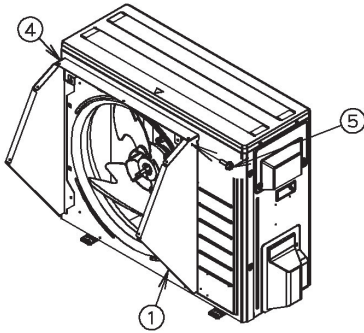
3 Attach the installation plate ④.

1. Install the side plate (right) ① and installation plate ④ with the 1 screws ⑤ included in the kit.

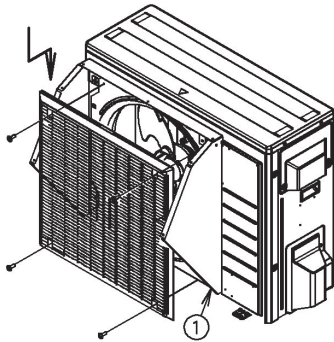
4 Attach the discharge grille.

1. When installing the discharge grille removed in [1], jointly tighten the side plate (right) ① with the 2 screws securing the discharge grille. (Secure the discharge grille with the 4 screws and 2 hooks.)

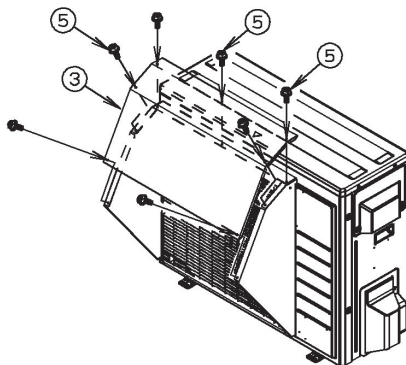
5 Attach the top plate ③.

1. Install the top plate ③ with the 7 screws ⑤ included in the kit.

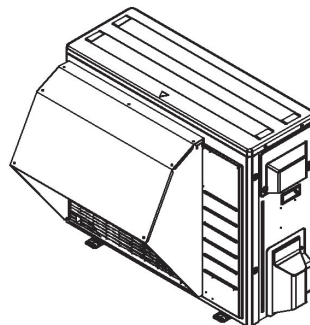
2 Appearance of the snow hood (outlet) after installation



Warning ● Ask a qualified installer or contractor to install this product. Do not try to install the product yourself.



Improper installation can result in water or refrigerant leakage, electrical shock, fire or explosion.

- Use only those parts and accessories supplied or specified by Daikin. Ask a qualified installer or contractor to install those parts and accessories. Use of unauthorised parts and accessories or improper installation of parts and accessories can result in water or refrigerant leakage, electrical shock, fire or explosion.
- Read the user's manual carefully before using this product. The user's manual provides important safety instructions and warnings. Be sure to follow these instructions and warnings.

If you have any inquiries, please contact your local importer, distributor and/or retailer.

Cautions on product corrosion

1. Air conditioners should not be installed in areas where corrosive gases, such as acid gas or alkaline gas, are produced.
2. If the outdoor unit is to be installed close to the sea shore, direct exposure to the sea breeze should be avoided. If you need to install the outdoor unit close to the sea shore, contact your local distributor.