

**DAIKIN**

# INSTALLATION MANUAL

## **VRV** System Inverter air conditioner

**Model**  
**One Way Blow Cassette Type**

**FXEQ07PVJU**  
**FXEQ09PVJU**  
**FXEQ12PVJU**  
**FXEQ15PVJU**  
**FXEQ18PVJU**  
**FXEQ24PVJU**

English

Français

Español

---

**CAREFULLY READ THESE INSTRUCTIONS BEFORE INSTALLATION.  
KEEP THIS MANUAL IN A HANDY PLACE FOR FUTURE REFERENCE.**

**VEUILLEZ LIRE ATTENTIVEMENT CES INSTRUCTIONS AVANT L'INSTALLATION.  
CONSERVEZ CE MANUEL EN LIEU SÛR POUR POUVOIR VOUS Y REPORTER ULTÉRIEUREMENT.**

**LEA DETENIDAMENTE ESTAS INSTRUCCIONES ANTES DE LA INSTALACIÓN CONSERVE ESTE  
MANUAL PARA POSIBLES CONSULTAS FUTURAS.**

---

**Thank you for purchasing this Daikin air conditioner.**

**Carefully read this operation manual before using the air conditioner. It will tell you how to use the unit properly and help you if any trouble occurs. This manual explains about the indoor unit only. Use it along with the operation manual for the outdoor unit. After reading the manual, file it away for future reference.**

**Nous vous remercions pour votre acquisition de ce système de climatisation Daikin.**

**Lisez attentivement ce manuel avant d'utiliser le climatiseur. Il vous expliquera comment vous servir correctement de l'appareil et vous guidera en cas de problème. Ce manuel ne décrit que l'unité intérieure. Utilisez-le avec le manuel de l'unité extérieure. Lorsque vous aurez lu le manuel, rangez-le afin de pouvoir vous y référer ultérieurement.**

**Le agradecemos la compra de este acondicionador de aire Daikin.**

**Lea cuidadosamente el manual de funcionamiento antes de utilizar el acondicionador de aire. Dicho manual le indicará cómo utilizar adecuadamente la máquina y le ayudará en caso de avería. Este manual describe sólo la unidad interior. Utilice conjuntamente con el manual de instrucciones de la unidad exterior. Después de leer el manual, consérvelo para consultas futuras.**

## SAFETY CONSIDERATIONS

Read these **Safety considerations for Installation** carefully before installing air conditioning equipment. After completing the installation, make sure that the unit operates properly during the startup operation.

Instruct the customer on how to operate and maintain the unit. Inform customers that they should store this Installation Manual with the Operation Manual for future reference.

Always use a licensed installer or contractor to install this product. Improper installation can result in water or refrigerant leakage, electrical shock, fire, or explosion.

Meanings of **DANGER**, **WARNING**, **CAUTION**, and **NOTE** Symbols:

 **DANGER**.....Indicates an imminently hazardous situation which, if not avoided, will result in death or serious injury.

 **WARNING**.....Indicates a potentially hazardous situation which, if not avoided, could result in death or serious injury.

 **CAUTION**.....Indicates a potentially hazardous situation which, if not avoided, may result in minor or moderate injury. It may also be used to alert against unsafe practices.

 **NOTE**.....Indicates situations that may result in equipment or property-damage accidents only.

---

### **DANGER**

- Refrigerant gas is heavier than air and replaces oxygen. A massive leak can lead to oxygen depletion, especially in basements, and an asphyxiation hazard could occur leading to serious injury or death.
- Do not ground units to water pipes, gas pipes, telephone wires, or lightning rods as incomplete grounding can cause a severe shock hazard resulting in severe injury or death. Additionally, grounding to gas pipes could cause a gas leak and potential explosion causing severe injury or death.
- If refrigerant gas leaks during installation, ventilate the area immediately. Refrigerant gas may produce toxic gas if it comes in contact with fire. Exposure to this gas could cause severe injury or death.
- After completing the installation work, check that the refrigerant gas does not leak throughout the system.
- Do not install unit in an area where flammable materials are present due to risk of explosions that can cause serious injury or death.
- Safely dispose all packing and transportation materials in accordance with federal/state/local laws or ordinances. Packing materials such as nails and other metal or wood parts, including plastic packing materials used for transportation may cause injuries or death by suffocation.

---

### **WARNING**

- Only qualified personnel must carry out the installation work. Installation must be done in accordance with this installation manual. Improper installation may result in water leakage, electric shock, or fire.
- When installing the unit in a small room, take measures to keep the refrigerant concentration from exceeding allowable safety limits. Excessive refrigerant leaks, in the event of an accident in a closed ambient space, can lead to oxygen deficiency.
- Use only specified accessories and parts for installation work. Failure to use specified parts may result in water leakage, electric shocks, fire, or the unit falling.
- Install the unit to a support structure that is strong enough to withstand the unit weight. A weak structure may result in the unit falling and causing injuries.
- Make sure that a separate power supply circuit is provided for this unit and that all electrical work is carried out by qualified personnel according to local, state and national regulations. An insufficient power supply capacity or improper electrical construction may lead to electric shocks or fire.
- Make sure that all wiring is secured, that specified wires are used, and that no external forces act on the terminal connections or wires. Improper connections or installation may result in fire.
- When wiring, position the wires so that the control box cover can be securely fastened. Improper positioning of the control box cover may result in electric shocks, fire, or the terminals overheating.
- Before touching electrical parts, turn off the unit.
- This equipment can be installed with a Ground-Fault Circuit Breaker (GFCI). Although this is a recognized measure for additional protection, with the grounding system in North America, a dedicated GFCI is not necessary.
- Securely fasten the outdoor unit terminal cover (panel). If the terminal cover/panel is not installed properly, dust or water may enter the outdoor unit causing fire or electric shock.
- When installing or relocating the system, keep the refrigerant circuit free from substances other than the specified refrigerant (R410A) such as air. Any presence of air or other foreign substance in the refrigerant circuit can cause an abnormal pressure rise or rupture, resulting in injury.
- Do not change the setting of the protection devices. If the pressure switch, thermal switch, or other protection device is shorted and operated forcibly, or parts other than those specified by Daikin are used, fire or explosion may occur.

---

### **CAUTION**

- Do not touch the switch with wet fingers. Touching a switch with wet fingers can cause electric shock.
- Do not allow children to play on or around the unit to prevent injury.
- Do not touch the refrigerant pipes during and immediately after operation as the refrigerant pipes may be hot or cold, depending on the condition of the refrigerant flowing through the refrigerant piping, compressor, and other refrigerant cycle parts. Your hands may suffer burns or frostbite if you touch the refrigerant pipes. To avoid injury, give the pipes time to return to normal temperature or, if you must touch them, be sure to wear proper gloves.
- Heat exchanger fins are sharp enough to cut.

To avoid injury wear glove or cover the fins when working around them.

- Install drain piping to proper drainage. Improper drain piping may result in water leakage and property damage.
- Insulate piping to prevent condensation.
- Be careful when transporting the product.
- Do not turn off the power supply immediately after stopping operation. Always wait for at least 5 minutes before turning off the power supply. Otherwise, water leakage may occur.
- Do not use a charging cylinder. Using a charging cylinder may cause the refrigerant to deteriorate.
- Refrigerant R410A in the system must be kept clean, dry, and tight.
  - (a) Clean and Dry – Foreign materials (including mineral oils such as SUNISO oil or moisture) should be prevented from getting into the system.
  - (b) Tight – R410A does not contain any chlorine, does not destroy the ozone layer, and does not reduce the earth's protection against harmful ultraviolet radiation. R410A can contribute to the greenhouse effect if it is released. Therefore take proper measures to check for the tightness of the refrigerant piping installation. Read the chapter Refrigerant Piping Work and follow the procedures.
- Since R410A is a blend, the required additional refrigerant must be charged in its liquid state. If the refrigerant is charged in a state of gas, its composition can change and the system will not work properly.
- The indoor unit is for R410A. See the catalog for indoor models that can be connected. Normal operation is not possible when connected to other units.
- Remote controller (wireless kit) transmitting distance can be shorter than expected in rooms with electronic fluorescent lamps (inverter or rapid start types). Install the indoor unit far away from fluorescent lamps as much as possible.
- Indoor units are for indoor installation only. Outdoor units can be installed either outdoors or indoors.
- Do not install the air conditioner or heat pump in the following locations:
  - (a) Where a mineral oil mist or oil spray or vapor is produced, for example, in a kitchen.  
Plastic parts may deteriorate and fall off or result in water leakage.
  - (b) Where corrosive gas, such as sulfuric acid gas, is produced.  
Corroding copper pipes or soldered parts may result in refrigerant leakage.
  - (c) Near machinery emitting electromagnetic waves. Electromagnetic waves may disturb the operation of the control system and cause the unit to malfunction.
  - (d) Where flammable gas may leak, where there is carbon fiber, or ignitable dust suspension in the air, or where volatile flammables such as thinner or gasoline are handled. Operating the unit in such conditions can cause a fire.
- Take adequate measures to prevent the outdoor unit from being used as a shelter by small animals. Small animals making contact with electrical parts can cause malfunctions, smoke, or fire. Instruct the customer to keep the area around the unit clean.

---

**NOTE**

- Install the power supply and transmission wires for the indoor and outdoor units at least 3.5 feet away from televisions or radios to prevent image interference or noise. Depending on the radio waves, a distance of 3.5 feet may not be sufficient to eliminate the noise.
  - Dismantling the unit, treatment of the refrigerant, oil and additional parts must be done in accordance with the relevant local, state, and national regulations.
  - Do not use the following tools that are used with conventional refrigerants: gauge manifold, charge hose, gas leak detector, reverse flow check valve, refrigerant charge base, vacuum gauge, or refrigerant recovery equipment.
  - If the conventional refrigerant and refrigerator oil are mixed in R410A, the refrigerant may deteriorate.
  - This air conditioner or heat pump is an appliance that should not be accessible to the general public.
  - As design pressure is 478 psi, the wall thickness of field-installed pipes should be selected in accordance with the relevant local, state, and national regulations.
-



# CONTENTS

|   |         |
|---|---------|
| Safety considerations .....   | [i][ii] |
| 1.Before installation .....   | 1       |
| 1-1.Caution.....  | 1       |
| 1-2.Accessories.....  | 2       |
| 1-3.Optional accessories.....   | 2       |
| 2.Selecting installation locations.....   | 3       |
| 3.Preparations before installation.....   | 3       |
| 4.Indoor unit installation.....   | 4       |
| 5.Decorative panel installation.....  | 4       |
| 6.Refrigerant piping installation .....   | 4       |
| 7.Drain piping installation .....   | 6       |
| 8.Electrical wiring work .....  | 7       |
| 8-1.Overview .....  | 7       |
| 8-2.Specifications of the standard electric wires .....   | 8       |
| 8-3.Electrical characteristics.....   | 8       |
| 9.Wiring example.....   | 8       |
| 9-1.How to connect power wiring, ground wires, remote controller wiring and transmission wiring ..... | 8       |
| 9-2.Two remote controllers control one indoor unit.....   | 10      |
| 9-3.Remote control (“Forced OFF” and “ON/OFF”) .....  | 11      |
| 9-4.Centralized control.....  | 11      |
| 9-5.Panel wire connecting.....  | 11      |
| 10.Decorative panel installation.....   | 11      |
| 11.Field settings and test run .....  | 11      |
| 12.Non-trouble symptoms .....   | 13      |

## 1. Before installation

Do not and never discard any required accessories until the installation is completed!

1. Determine the move-in route of the air conditioner.
2. Do not remove the packing until carrying the unit to the installation locations.If the packing has to be removed, use a soft sling or put a protective plate under sling to lift the unit up and prevent the unit from being damaged or scratched.

No matter during or after unsealing, grasp the hanger bracket when carrying the air conditioner. Do not put any stress to the refrigerant piping, drain piping or plastic parts.

Check the refrigerant is R410A before installing the air conditioner. For installing the outdoor unit, refer to the installation manual included with it.

- Do not install or use the air conditioner in the following locations:
    - Where the mineral oil, oil fume or spray is full of, for example, a kitchen. (Plastic parts may be aged and lead to unit's falling or water leakage finally.)
    - Where there is corrosive gas, such as sulfurous acid gas. (Copper pipes or soldered parts may be corroded and result in refrigerant leakage finally.)
    - Where there is flammable gas or volatile flammables such as gasoline or thinner is used. (Gases around the air conditioner may result in fire.)
    - Where there is machinery emitting electromagnetic waves. (Controlling system may not work.)
    - Where the content of the salt in the air is high, for example, on the coast, or where there is large voltage fluctuation, such as in the factory.
- Besides, it is also not suitable for vehicles or ships.
- This series air conditioner (including the indoor unit and outdoor unit) is suitable for household, business and light industry.

### 1-1.Caution

- Carefully read this manual before installing the indoor unit.
- Always ask the dealer or specialized personnel to carry out the installation work. Improper installation may result in water leakage, electric shocks or fire hazards.
- Only use the accessory components and parts or the ones in conformity with the technical specifications. Disqualified components and parts may result in the unit falling, water leakage, electric shocks or fire hazards.
- Explain the users how to operate the air conditioner's each function properly and how to regulate the temperature. Ask them to operate personally while reading the operation part under this manual.

### 1-2. Accessories

Check if the following accessories are supplied with your air conditioner.

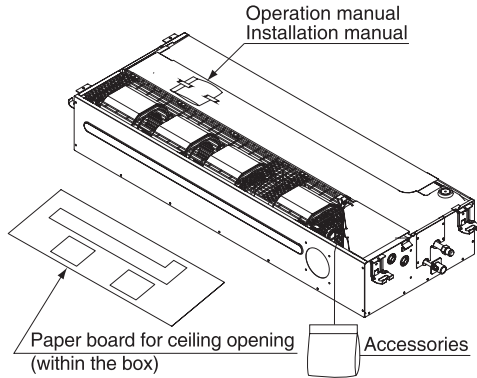

| Description | ① Drain hose | ② Metal clip | ③ Hanger bracket washers | ④ Clamps | ⑤ Lifting screw mounting paper pattern |
|-------------|--------------|--------------|--------------------------|----------|--|
| Quantity    | 1            | 1            | 8                        | 6        | 1                                      |
| Shape       |              |              |                          |          | <br>Also used as packaging             |

| Description | ⑥ Screws (M5)                     | ⑦ Washer fixing plate | Piping insulation material                            | Insulation material                     |
|-------------|-----------------------------------|-----------------------|---|---|
| Quantity    | 4                                 | 1set                  | 1 for each  | 1 for each                              |
| Shape       | <br>Mounting paper pattern screws |                       | <br>⑧ For gas side piping<br>⑨ For liquid side piping | <br>⑩ Large<br>⑪ Medium-1<br>⑫ Medium-2 |

| Description | Insulation material | Insulation tube | Conduit mounting plate | (Others)   |
|-------------|---------------------|-----------------|------------------------|--|
| Quantity    | 2                   | 1               | 1                      | • Operation manual<br>• Installation manual<br>• Paper board for ceiling opening |
| Shape       | <br>⑬               | <br>⑭           | <br>⑮<br>⑯             |  |

### 1-3. Optional accessories

- One wired remote controller BRC1E73 used for operation is required for the indoor unit.

**When performing installation work or checking after completing installation, pay special caution to the following items.**

#### a. Main check items after completing installation.

| Check items   | Result of improper installation in by improper installation        | Signature after checking |
|---|--|--------------------------|
| Are the indoor and outdoor units installed properly?  | Unit is not secured vibrating or producing abnormal noise.         |                          |
| Has the installation work of outdoor unit been completed?                                     | The unit doesn't operate normally or with parts burnt out.         |                          |
| Is the refrigerant leak inspection performed?   | Insufficient cool air or hot air.                                  |                          |
| Is the unit insulated correctly? (refrigerant piping, drain piping and air duct)              | Condensed water dripping.  |                          |
| Is the condensate drainage draining correctly?  | Water leakage.   |                          |
| Is the power voltage consistent with the specified voltage on the nameplate of the unit?      | The unit doesn't operate normally or with parts burnt out.         |                          |
| Are the wiring and piping connected properly?   | The unit doesn't operate normally or with parts burnt out.         |                          |
| Is the unit grounded safely?  | Causes electric shock and may result in fire current leaks.        |                          |
| Are the specified wires used?   | The unit doesn't operate normally or with parts burnt out.         |                          |
| Are the indoor and outdoor units' air inlet and outlet blocked by any obstacles?              | Insufficient cool air or hot air.                                  |                          |
| Are the refrigerant piping length and refrigerant charging amount recorded?                   | The refrigerant charging amount is not clear.                      |                          |
| Are the binding screws loose?   | Electric shocks or fire hazards.                                   |                          |
| Are the indoor unit and panel secured tightly?  | Water leakage; condensed water dripping; producing abnormal noise. |                          |
| Are the panel and ceiling matched mutually according to this operation & installation manual? | Unit's panel falling off, vibrating, producing abnormal noise.     |                          |

Refer to the chapter of "Safety considerations" simultaneously.

#### b. Main hand-over check items.

| Check items  | Signature after checking |
|--|--------------------------|
| Are the electrical component box cover, air filter and intake calamus installed?                     |                          |
| Have the uses and operation procedure, mentioned in the operation manual been explained to the user? |                          |
| Have the manuals for the unit been handed over to the user?  |                          |
| If applicable, have the manuals for field supplied products been handed over to the user?            |                          |

### c. Commentary key points about the application methods.

Contents marked with ⚠ Warning and ⚠ Caution in the operation manual emphasize the matter that failure to follow the normal unit operation methods may result in personal injury and property damage. It is necessary to explain the contents of the precautions to the users clearly and ask them to read the operation manual.

## 2. Selecting installation locations

### ⚠ Caution

- Be sure to grasp the hanger bracket when carrying the air conditioner with the package being opened or already opened. Do not put any stress to other parts especially the refrigerant piping, drain piping and flange.
- If temperature within the ceiling interlayer may exceed 86°F (30°C) and the humidity over HR80%, thicken the insulation material of the unit body.  
Adopt glass wool or EPE (thickness at least 3/8 in. (10mm) and able to be gathered in the ceiling opening) as the insulation material.

(1) Unit should be installed in a location that meets all the conditions mentioned below:

- Has good ventilation.
- Has unrestricted surrounding to allow air flow.
- Able to discharge condensate water smoothly.
- Ceiling is strong enough to support unit weight.
- Ceiling is not sloped or tilted.
- No risk of flammable gas leaks.
- Adequate service space can be provided around the unit.
- Length of piping between indoor and outdoor unit is within allowable range.

(Refer to the installation manual of outdoor unit.)

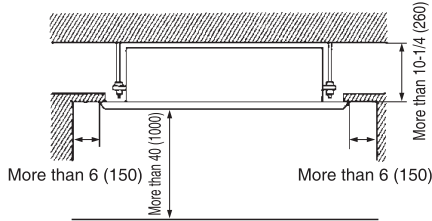

Figure 1

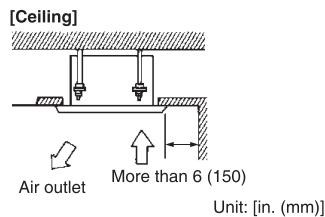

Figure 2

### [Note]

- Install the indoor unit, outdoor unit, power wiring and transmission wiring at least 40 in. (1m) away from televisions and radios to prevent image interference and noise. (Depending on the radio waves, a distance of 40 in. (1m) may not be sufficient to eliminate the interference in some instances.)

(2) Perform installation with a lifting screw. Study if the ceiling is solid enough to hold the weight of the indoor unit. If the ceiling is not solid enough, reinforce the ceiling in advance.

(Refer to the spacing marked on the packaging box and check if it is necessary to reinforce.)

(3) Ceiling height

The indoor unit can be mounted to the ceiling with height not exceeding 11-1/2 ft. (3.5m). However, if the ceiling height exceeds 8-3/4 ft. (2.7m), make the onsite settings using the remote controller. Refer to the chapter "11. Field settings and test run".

## 3. Preparations before installation

(1) Determine the relative positions of the ceiling opening, units and lifting screw. (Unit [in. (mm)])

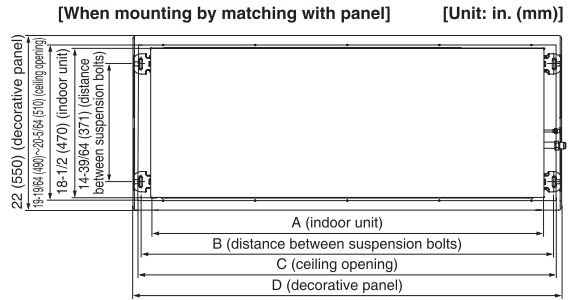

| Model          | A               | B               | C                                   | D              |
|----------------|-----------------|-----------------|-------------------------------------|----------------|
| FXEQ07-15PVJU. | 33-5/64 (840)   | 35-35/64 (903)  | 33-55/64 (860)~<br>35-53/64 (910)   | 37-13/32 (950) |
| FXEQ18-24PVJU. | 48-13/16 (1240) | 51-19/64 (1303) | 49-39/64 (1260)~<br>51-37/64 (1310) | 53-5/32 (1350) |

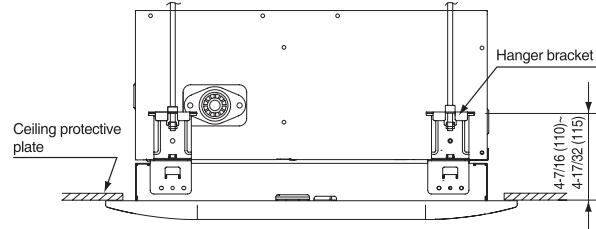

Figure 3

### <Note>

Overlaps of the ceiling and the decorative panel should be 25/32 in. (20mm) over. Distance between the indoor units and the ceiling should not exceed 1-3/8 in. (35mm). If it is over 1-3/8 in. (35mm), thicken the ceiling material at ■ position or repair the ceiling again.

[Refer to the following figure]

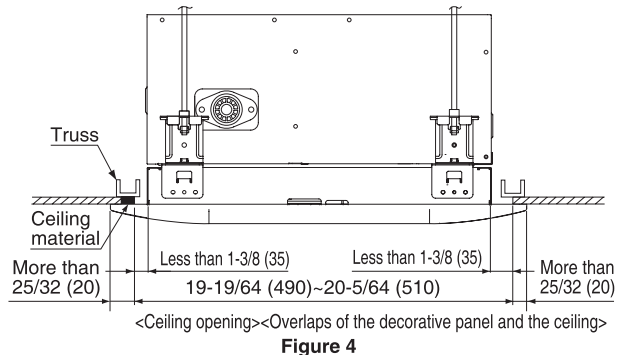

Figure 4

(2) If necessary, punch through the opening needed for installation on the ceiling. (For locations already having had the ceiling)

- For dimensions of the ceiling opening, refer to the paper board for ceiling opening (within the bottom box).
- Prepare all the pipes (refrigerant piping and drain piping) and electric wires (remote controller wiring, indoor and outdoor units' connection wiring and power wiring) to be connected to the indoor units before installation.
- After punching through the ceiling opening, in order to keep the ceiling flat and prevent it from vibrating, it may be necessary to reinforce the ceiling bracket.

- (3) Install the suspension rod screw (use W3/8 or 7/16 in. (M10) bolts)
- In order to withstand the weight of the units, use foundation bolts for locations already having had the ceiling and embedded anchor bolts, buried anchor bolts or other field-supply parts for the newly-mounted ceiling. Before continuing installation, adjust the clearance between the suspension screw and the ceiling to 2-4 in. (50-100mm).

#### [Installation example]

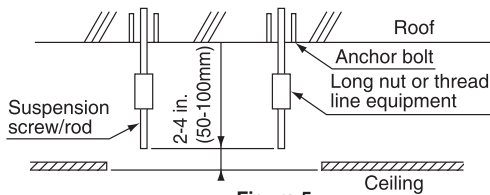

Figure 5

Note) All the above parts are supplied at the installation site.

## 4. Indoor unit installation

Be sure to use only the specified parts for installation work.  
Installation procedure for locations with newly-mounted ceiling:

(1) → (2) → (3) → (4) → (5)

Installation procedure for locations with existing ceiling:

(1) → (3) → (4) → (5)

(1) Temporarily install the indoor units

- Attach the hanger bracket to the lifting screw. Be sure to secure the hanger bracket firmly at the upper and lower ends using the nuts and hanger washers ③. The washer fixing plate ⑦ can prevent the hanger washer ③ from slipping off.

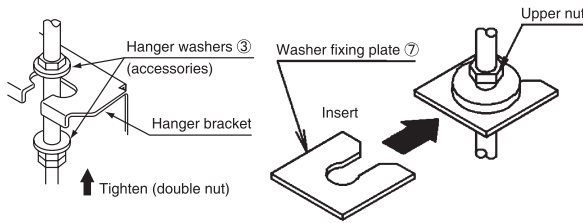

[Secure the hanger bracket]

Figure 6

[Secure the washer]

Figure 7

- (2) For dimensions of the ceiling opening, refer to the paper board for ceiling opening.
- Center of the ceiling opening is marked on the paper board for ceiling opening. Center of the units is in line with that of the ceiling opening.
  - Fix the paper board for ceiling opening to the units using 4 screws ⑥. In this case, make the hole on the unit's hanger bracket corresponded to the mounting hole on the paper board for ceiling opening.
  - Relative positions of the main unit and ceiling are marked on the paper board for ceiling opening. Adjust the height of the unit body accordingly.

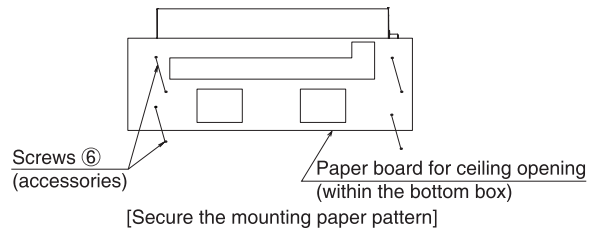

Figure 8

(3) Adjust the level of the air conditioner.

- The indoor unit is equipped with a built-in drain pump and float switch. Adjust the level using a level or polyethylene pipe filled with water.

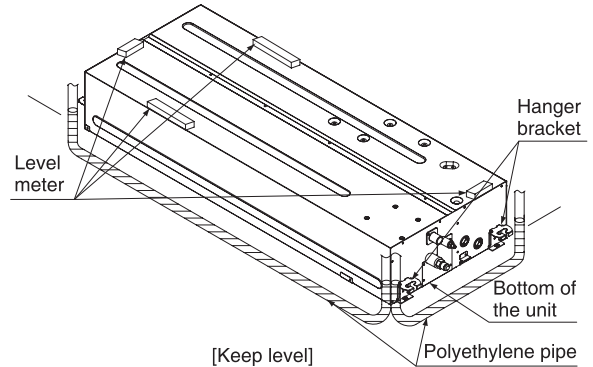

Figure 9

### ⚠ Caution

If the unit is not installed completely horizontal, the float switch will not operate normally leading to damages from water leakage.

- (4) Pull out the inserted washer fixing plate ⑦ which is used to prevent the washer from slipping off and tighten the upper nut.
- (5) Remove the paper board for ceiling opening.

## 5. Decorative panel installation

<Refer to panel operation & installation manual for detailed decorative panel installation.>

## 6. Refrigerant piping installation

<For installing the refrigerant piping of the outdoor unit, refer to the installation manual included with the outdoor unit.>

<Insulate both gas side piping and liquid side piping effectively. Otherwise, it may cause water leakage. Use the insulation material which can withstand high temperature of 250°F (120°C) or more. In addition, the insulation material must be able to withstand the environment where the pipes are located.>

<Be sure to check the refrigerant is R410A before performing refrigerant piping installation. Adopting other refrigerants may result in the abnormal operation of the unit.>

### ⚠ Caution

This product is designed to work with refrigerant R410A. Always follow the instructions below to perform installation work.

- Be sure to use pipe cutters and flaring tools for R410A.
- When connecting the flaring, only coat the refrigerant oil (ester or ether oil) to the inner side of the flaring.
- Always use the flaring nut included with the unit. (Do not use other flaring nuts such as 1-type flaring nut. Using other flaring nuts may lead to refrigerant leakage.)
- To prevent entry of any dirt, dust or moisture into the piping, adjust the piping through pinching or sealing methods.

**Caution**

- Be sure to use the specified refrigerant during refrigerant circulation and prevent the air from contaminating the refrigerant.
- If refrigerant leaks during installation work, make sure to ventilate the rooms.

(1) Connect the piping.

- The outdoor unit have been charged with the refrigerant.
- Position the refrigerant piping connector section at the center of the flaring part. Turn 3~4 circles with your hands and tighten with the specified tightening torque.
  - To prevent the flaring part from cracking or leaking gas, tighten with a torque wrench. **(Refer to Figure 10)**
- To prevent gas leakage, coat the refrigerant oil (ester or ether oil) to the inner side of the flaring part. **(Refer to Figure 11)**
- Secure the flaring nut to the main unit. (To prevent the flaring nut from aging and cracking)
- Refer to Table 1 for the flaring size and tightening torque.

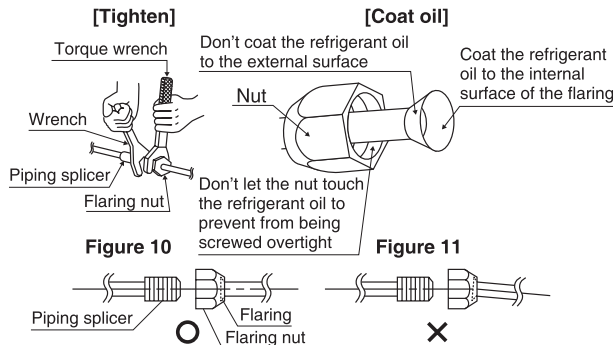

Note: Make sure to align the center of the refrigerant piping connector part with the ones of the flaring part and flaring nut.  
Failure to do so may result in pipe breakage or refrigerant leakage.

**Table 1**

| Pipe size [in. (mm)] | Tightening torque [lbf-ft. (N-m)] | Flaring size A [in. (mm)] | Flaring |
|----------------------|-----------------------------------|---------------------------|---------|
| Φ 1/4 (6.4)          | 10.4-12.7 (15.7±1.5)              | 0.342-0.358 (8.9±0.2)     |         |
| Φ 3/8 (9.5)          | 24.1-29.4 (36.3±3.6)              | 0.504-0.520 (13.0±0.2)    |         |
| Φ 1/2 (12.7)         | 36.5-44.5 (54.9±5.4)              | 0.638-0.654 (16.4±0.2)    |         |
| Φ 5/8 (15.9)         | 45.6-55.6 (68.6±6.8)              | 0.760-0.776 (19.5±0.2)    |         |

**Caution**

Use of excessive force or overtightening of the nut will damage the flaring and result in refrigerant leakage.

Do not apply oil to parts other than the flare nut.

- If a torque wrench is unavailable, refer to Table 2.

Use of a torque wrench is recommended to tighten the flare nut. However if a torque wrench is unavailable, follow the procedure mentioned below for safe installation.

After completing installation work, be sure to check for gas leakage.

When tightening the flaring nut with a wrench, the tightening torque will suddenly increase at certain position. In this case, continue rotate the flaring nut to the following angles from this position.

**Table 2**

| Piping size [in. (mm)] | Further tightening angle | Recommended tool arm length |
|------------------------|--------------------------|-----------------------------|
| Φ 1/4 (6.4)            | 60 ~ 90 degrees          | 6 in. (150mm) around        |
| Φ 3/8 (9.5)            | 60 ~ 90 degrees          | 8 in. (200mm) around        |
| Φ 1/2 (12.7)           | 30 ~ 60 degrees          | 10 in. (250mm) around       |
| Φ 5/8 (15.9)           | 30 ~ 60 degrees          | 12 in. (300mm) around       |

- (2) After completing piping connections, check for refrigerant leaks.
- (3) After ensuring that there are no refrigerant leaks, insulate the piping connections adequately with the insulation material provided.

**(Refer to Figure 12)**

- When performing insulation, attach the included joint insulation parts ⑧ and ⑨ to the liquid side piping and gas side piping. In addition, make the seams of the joint insulation parts ⑧ and ⑨ face upward. (Pinch both ends with the clamps ④.)
- For the liquid side piping and gas side piping, wrap the medium insulation material ⑪ and ⑫ to the joint insulation parts ⑧ and ⑨. (Flaring nut part)



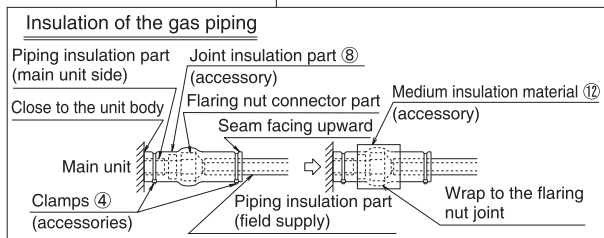
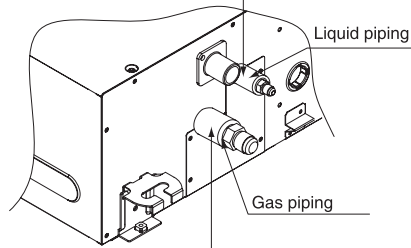
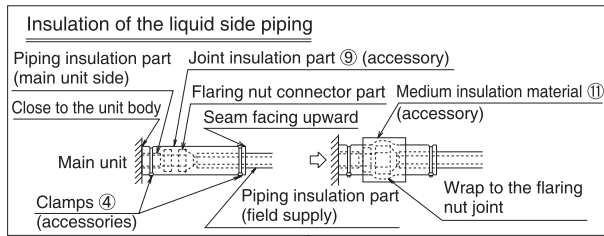

Figure 12

**Caution**

Insulate all piping connections leaving the pipes uninsulated may result in condensation on pipes and burns.

- Before brazing the refrigerant piping, perform nitrogen replacement, or charging nitrogen into the refrigerant piping (Caution 1) during brazing (Caution 2), then connect with the indoor unit using the flaring.
- (Refer to Figure 13)

**Caution**

1. When charging nitrogen into the piping for brazing, set the pressure to 2.9 psi (0.02 MPa) using pressure-reducing valve (as a slight breeze on your cheek).
2. Do not use flux when brazing the refrigerant piping connector part. Use the phosphor copper electrode which does not require flux (BCuP-2:JIS Z 3264 / BCu93P-710/795:ISO 3677). (If the chlorine based flux is used, it will cause pipe corrosion; if the flux contains fluorine, it will damage the ester or ether oil and further adversely affect the refrigerant piping system.)
3. Make sure to use the following refrigerant piping Material: Jointless phosphor-deoxidized copper pipe.
4. Do not use any anti-oxidants when brazing the piping. The residual anti-oxidants may clog the piping and result in malfunction of the parts.

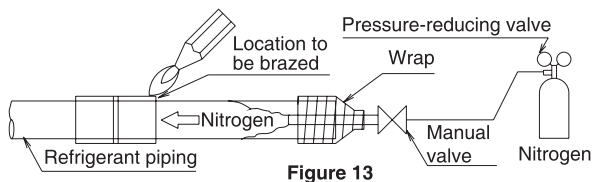
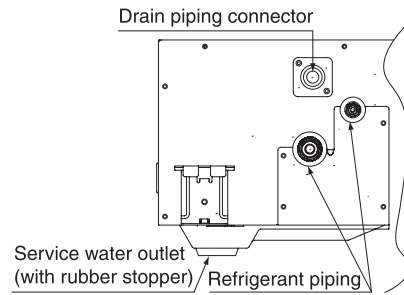

Figure 13

## 7. Drain piping installation

(1) Install the drain piping.



- Ensure proper drainage through the installed drain pipes.
- Diameter of the drain piping must be equal to or greater than that of the connecting pipes. (Polyethylene pipe; piping size: 1 in. (25mm); outer diameter: 1-13/50 in. (32mm)) (Excluding the lifting pipes)
- To prevent the air pockets from being formed, shorten the drain piping as much as possible and slant it downward. The gradient should be 1/100 or more. (Refer to Figure 14)

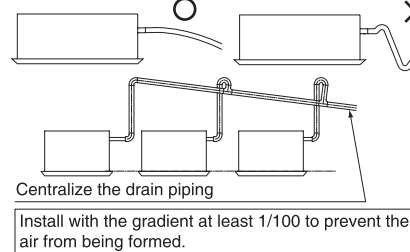

Figure 14

- To prevent the piping from bending and sagging down, secure them every 3~5 feet (1 ~ 1.5m) using slings.
- Use the accessory drain hose (1) and metal clip (2). The drain hose (1) should be inserted till the end of the drain socket and secured firmly to the marker at the front end of the hose using the metal clip (2). Tighten the metal clip (2) till the raised distance of the screw head less than 5/32 in. (4mm). (Refer to Figures 15 and 16)
- The following two parts must be insulated to prevent condensation and dripping.
  - Indoor drain hose
  - Drain socket

As shown in the figure below, insulate the metal clip (2) and drain hose (1) with the large insulation material (10) shipped with the unit (accessory). (Refer to Figure 16)

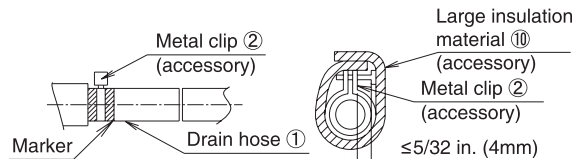

Figure 15

Figure 16

**<Precautions for installing drainage lifting pipe>**

- Make sure the height of the drainage lifting pipe is within 25 in. (635mm).
- Keep the drainage lift pipe vertical and no more than 11-3/4 in. (300mm) away from the air conditioner. (Refer to Figure 17)

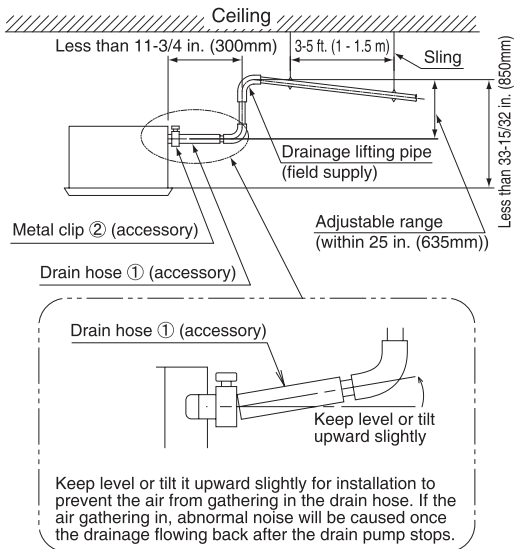

Figure 17

**<Note>**

**Drain piping connection**

- Do not connect drain piping directly to sewage pipes where ammonia odor may be present. Ammonia in the sewage pipes may enter the indoor unit body through the drain piping and corrode the heat exchanger.
- Do not twist or bend the drain hose ①, also do not apply excessive force. Failure to do so will result in water leakage.
- To use the converging drain piping, connect in accordance with Figure 14.
- Select the converging drain piping with proper size in accordance with the capacity of the unit to be connected.

(2) Check if the drainage is proper after completing installation.

**After completing wiring installation**

- To prevent water from gathering in the electrical components such as the drain pump, add about 1/4 gal. (1L) water slowly from the air outlet. Check the drainage condition in accordance with the “11. Field settings and test run” while performing cooling operation.

**During wiring installation**

**Caution**

- All electrical work (including grounding) must be carried out by the electricians with professional qualifications.
- If the electricians are absent from the site, check the drainage using steps 3 to 6 after the system test run is stopped.

1. Remove the electrical component box cover and connect the single-phase 60Hz, 208/230V power circuit to the L1 and L2 of the power terminal block.
2. Check if the electrical component box cover has been fastened completely before turning on the power supply.
3. Turn on the power supply to start the drain pump. It is possible to check the drainage condition through the transparent part of the drain socket. (The drain pump will stop automatically after 10 minutes.)

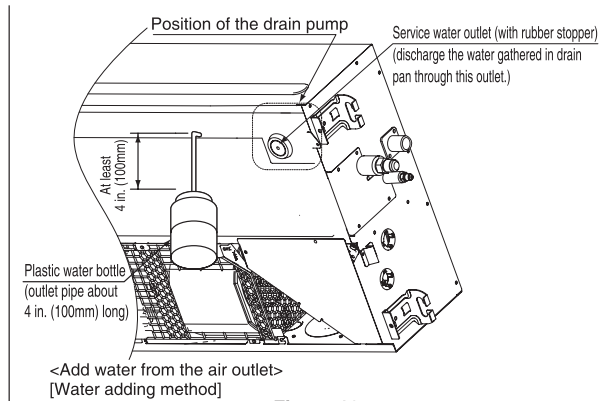

Figure 18

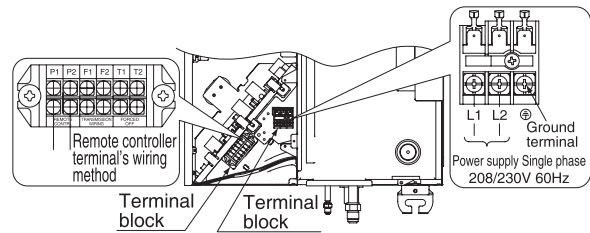

Figure 19

**Caution**

Exercise caution while opening the access panel to the unit since.

- a) The fan would be operating and touching the fan will lead to severe injury.
- b) The drain pump has live voltage and touching it will cause severe shock.

4. After completing drainage inspection (Figures 18 and 19), shut off the power supply and remove the power wiring.
5. Attach the electrical component box cover as original.

## 8. Electrical wiring work

### 8-1. Overview

- Always shut down the power supply before performing any electrical work.
- All locally-purchased parts & materials and electrical work must comply with local codes.
- Use copper conductors only.
- When performing the electrical wiring work, refer to the “Wiring diagram” labeled to the electrical component box cover simultaneously.
- For details of the remote controller’s wiring, refer to the “Remote controller installation manual” included with it.
- All wiring work must be carried out by the qualified electricians.
- The system includes several indoor units. Name each indoor unit after A unit, B unit... and make sure that the numbers of the wires connected from the terminal blocks are consistent with that of the outdoor unit and BS unit. Incorrect wire and piping connection between the indoor unit and outdoor unit will result in the air conditioning system abnormally operating. To prevent error occurring, perform wiring by referring to [Wiring example].



- Be sure to install a line breaker or Ground-Fault circuit breaker near the power supply.
- The ground resistance should not exceed 4Ω.
- Do not connect the ground wire to the gas pipes, water pipes, lightning rods or telephone earth wires.
  - Gas pipes: gas leakage can cause explosion or fire.
  - Water pipes: cannot be grounded if hard polyethylene pipes are used.
  - Telephone ground wires and lighting rods: the ground potential when struck by lightning gets extremely high.
- To prevent short circuit of the power wiring, terminals with insulation sleeves must be used.
- Do not turn on the power supply (line breaker or Ground-Fault circuit breaker) before completing all electrical work.

## 8-2.Specifications of the standard electric wires

### Power wiring, etc.

| Power wiring (including the ground wires) |     |                |                                       |
|---|-----|----------------|---------------------------------------|
| Unit quantity                             | MOP | Electric wires | Size                                  |
| 1   | 15A | H05VV-U3G      | Comply with the relevant local codes. |

| Transmission wiring & remote controller wiring |                         |
|--|-------------------------|
| Electric wires (Note 4)                        | Size (mm <sup>2</sup> ) |
| Polyethylene sheathed flexible wires or cables | AWG 18-16 (0.75-1.25)   |

### Note

1. It is possible to have the overcurrent circuit breaker instead of the fuse.
  2. If the electric wires are located in the places where they are easy to be touched by personnel, mount the earth leakage circuit breaker to prevent electric shocks.
  3. Use the earth leakage circuit breaker compatible with the appliances for grounding over-current protection and short circuit protection. If the ground protection special appliance is mounted to the earth leakage circuit breaker, be sure to mount a line breaker together.
- Lengths of the transmission wiring and remote controller wiring are indicated below.

| Outdoor unit to be connected    | VRV-S series   | VRV series  |
|---------------------------------|--|---|
| Outdoor unit – Indoor unit      | Maximum 984 ft. (300m)<br>(Total wiring length: 1969 ft. (600m)) | Maximum 3280 ft. (1000m)<br>(Total wiring length: 6560 ft. (2000m)) |
| Indoor unit – Remote controller | Maximum 984 ft. (300m)   | Maximum 1640 ft. (500m)   |

- Wrap the shielded part with insulation tape, etc. to prevent it from touching with other terminals.
- 4. Fuse specifications of the board are:  
250V 3.15A (F1U)  
 ⚠Warning: If the fuse is blown, ask the service agency to replace it. Do not replace it by yourself. Otherwise, it may lead to the accidents such as electric shocks.
- 5. Since this unit is equipped with an inverter, to prevent malfunction of the Ground-Fault circuit breaker itself, select the breaker that be capable of handling high harmonics.

## 8-3.Electrical characteristics

| Air conditioner |    |          |                              | Power supply |     | Fan motor |     |
|-----------------|----|----------|------------------------------|--------------|-----|-----------|-----|
| Model           | Hz | Voltage  | Voltage range                | MCA          | MOP | KW        | FLA |
| 07              | 60 | 208/230V | Minimum 187V<br>Maximum 253V | 0.3          | 15  | 0.087     | 0.2 |
| 09              |    |          |                              | 0.4          |     | 0.087     | 0.3 |
| 12              |    |          |                              | 0.4          |     | 0.087     | 0.3 |
| 15              |    |          |                              | 0.5          |     | 0.087     | 0.4 |
| 18              |    |          |                              | 0.5          |     | 0.117     | 0.4 |
| 24              |    |          |                              | 0.7          |     | 0.117     | 0.5 |

MCA: Minimum circuit current (A)

MOP: Max. Overcurrent Protective Device (A)

KW: Fan motor rated output power (kW)

FLA: Full-load current (A)

## 9. Wiring example

### 9-1.How to connect power wiring, ground wires, remote controller wiring and transmission wiring

(As shown in the figure below, connect the wires after opening the electrical component box cover.)

- (1) Remove the electrical component box cover. After sliding the electrical component box cover to the end in the glide direction of it, grasp the handle of the electrical component box cover to remove.

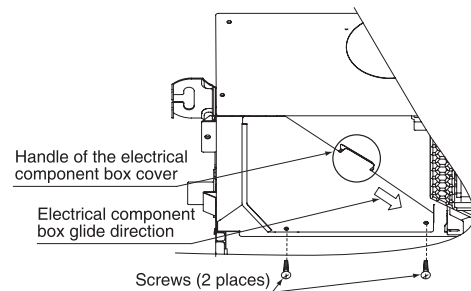

- (2) Connect the electric wires into the electrical component box through the inlet port on one side.

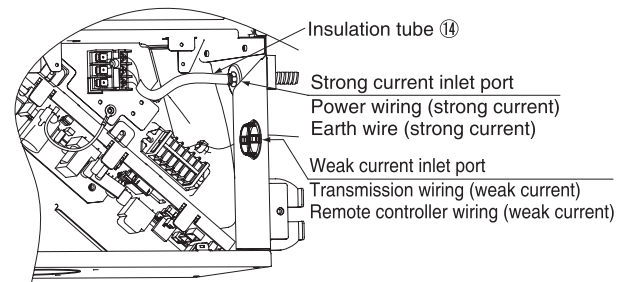

### ⚠ Caution

- Outside the air conditioner, don't route the remote controller wiring and transmission wiring together with other electrical wiring. Keep the remote controller wiring and transmission wiring at least 2 in. (50mm) away from the power wiring and other electrical wiring. Otherwise, being affected by the electrical interference (external noise) may result in malfunction and breakdown.
- Keep the field power wiring at least 5 in. (127mm) away from the field weak wiring.
- For installation and wiring of the remote controller, refer to the "Remote controller installation manual" included with it.

- When connecting the power supply of the air conditioner, refer to the "Wiring diagram" simultaneously.
- Correctly connect the remote controller wiring and transmission wiring to their corresponding terminals.

(3) Connect the wires in the electrical component box as shown in the figure below.

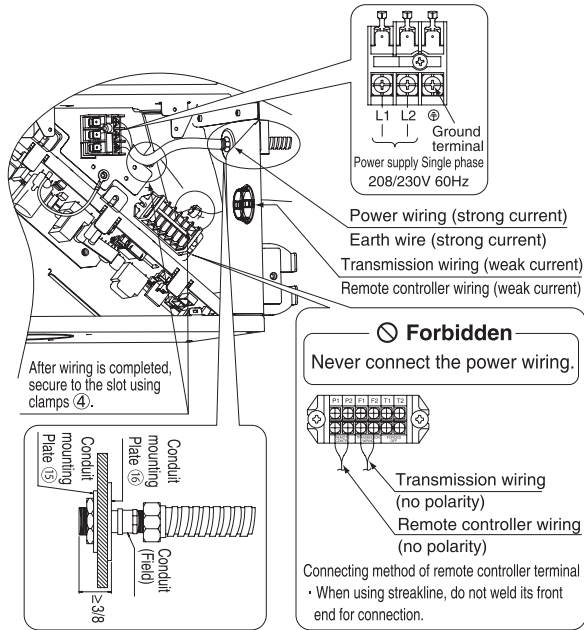

**Warning**

When connecting the wires and fasten the electrical component box cover securely. Incorrect wiring electrical component box cover being protruded may result in electric shocks or fire hazards.

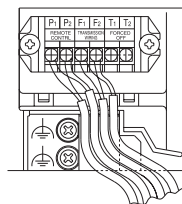

Figure 20

- Power wiring and earth wires  
Open the electrical component box cover. Then, lead the electric wires into the air conditioner through electric-wire-through part and connect them to the terminal block 3P. In addition, be sure to gather the wiring protective sleeves into the electrical component box.
- Remote controller wiring and transmission wiring  
Lead the electric wires into the air conditioner through electric-wire-through part and connect them to the terminal block 6P. In addition, be sure to gather the wiring protective sleeves into the electrical component box.

**[Wiring example]**

**Caution**

- The electric wires must be passed through the electric-wire-through part.

- After connecting the wires, take measures to protect the electric wires and the electric-wire-through part, to prevent the entry of the water and small animals.
- Wrap the sealing material ⑬ to the strong current and weak current electric wires as the figure below.  
(Entry of the water or small animals such as insects may result in short circuit of the electrical component box.)  
Wrap the sealing material tightly, with no clearance being left.

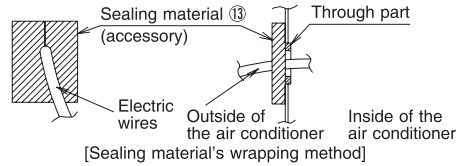

**System 1 1 remote controller controls 1 indoor unit**

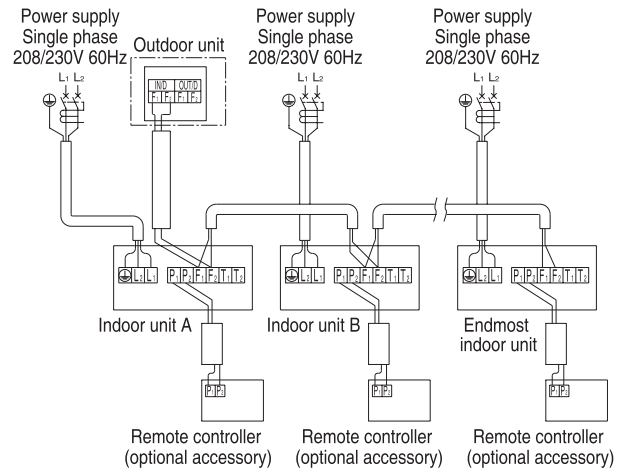

Figure 21

**System 2 Group control or 2 remote controllers control 1 indoor unit**

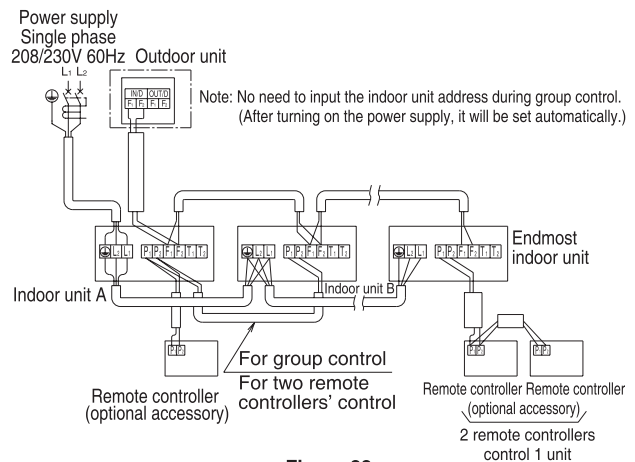

Figure 22

### System 3 When equipped with a BS unit

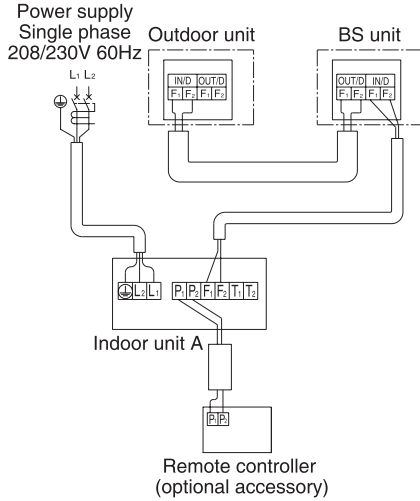

Figure 23

#### [Note]

1. If there is no need to install the Ground-Fault circuit breaker: mount the line breaker or load switch with fuse. If there is a need to install the earth leakage circuit breaker: mount the earth leakage circuit breaker compatible with appliances for grounding, over load and short circuit protection.
2. The remote controller wiring (P1 and P2) and transmission wiring (F1 and F2) is of no polarity.

#### <Precautions to power wiring connection>

- Never connect two wires of different size to the same power supply terminal. (Loose electric wire connection may cause abnormal heating.)
- When connecting to the terminal blocks, use the circular terminal with insulation sleeve. If not available, connect the wires of the same size to the sides respectively as shown in the figure.

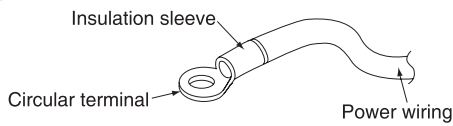

Connect the wires of the same size to the sides respectively. Never connect two wires of the same size to one side. Never connect two wires of different size.

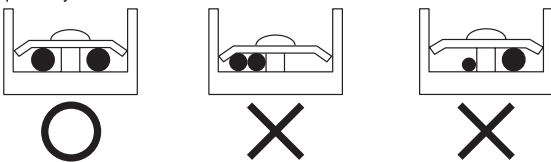

Phenomenons such as loose electric wire connection may cause abnormal heating. Strictly follow the instructions below.

- Use the specified power wiring and secure them firmly. Check if there is external stress applied to the terminal block.
- Tighten the terminal screws with a suitable screwdriver. Use of small screwdriver would damage the screw head and could not achieve the proper tightening effect.
- Secure the terminal screws overtight may break them.
- Refer to the table below for the tightening torque of the terminal screws.

| Terminals   | Tightening torque<br>(lb·ft. (N · m)) |
|---|---------------------------------------|
| Terminal block for remote controller/<br>transmission wiring (6P) | 0.58-0.71 (0.79-0.97)                 |
| Power supply terminal block (3P)                                  | 0.86-1.05 (1.18-1.44)                 |
| Grounding terminal  |                                       |

### 9-2. Two remote controllers control one indoor unit

- When using two remote controllers, it is necessary to set one as “M” and the other as “S”.

#### Changeover of “M” / “S”

- (1) Insert a ⊖ screwdriver into the seam of the remote controller's upper part and lower part, then apply force from 2 places to pry up the upper part carefully. PC board of the remote controller is equipped in the remote controller's upper part.

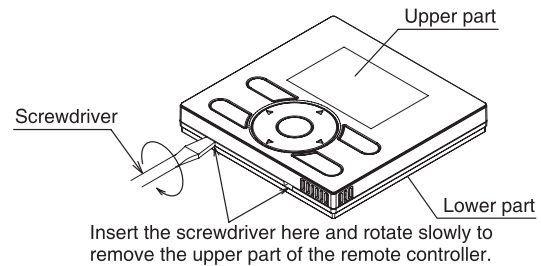

Insert the screwdriver here and rotate slowly to remove the upper part of the remote controller.

- (2) Set the M/S switch of any one remote controller's PC board to “S”.

(The other one still is “M”.)

(Factory setting) M S



If the factory setting has not been changed, then only one remote controller's setting needs to be changed.

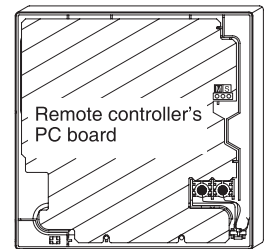

Connecting method (refer to the chapter of “Electrical wiring work”.)

- (3) Remove the electrical component box cover.
- (4) Connect the remote controller 2 (S) to the remote controller's wiring terminal blocks (P1, P2) in the electrical component box. (No polarity)

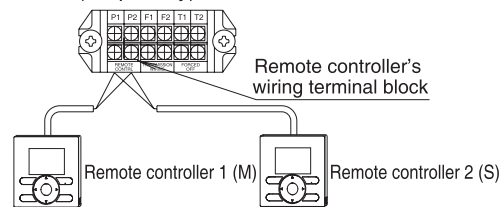

#### [Note]

- If group control and two remote controllers are used together, it is necessary to connecting jumping wires.
- Connect the remote controller 2 (S) to the indoor unit at the end of the jumping wires (P1, P2).

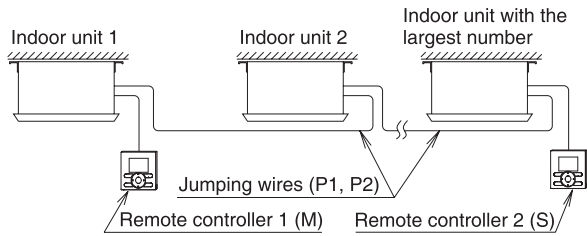

### 9-3.Remote control (“Forced OFF” and “ON/OFF”)

- Connect the input wire from the outside to the terminals T1 and T2 on the remote controller’s terminal block 6P to perform remote control.
- For detailed operation, refer to the “11. Field settings and test run”.

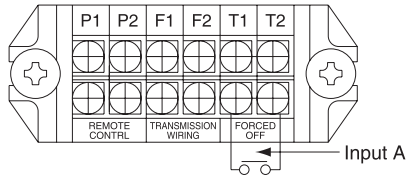

|                     |   |
|---------------------|---|
| Wire specifications | Polyethylene sheathed flexible wire or cable (2-core) |
| Sectional area      | AWG 18-16 (0.75-1.25mm <sup>2</sup> )                 |
| Length              | Maximum 328 ft. (100m)                                |
| External contact    | The minimum allowable load: 15V DC, 10mA              |

### 9-4.Centralized control

- To control centrally, the group number must be set. For details, refer to the manual of centralized controller.

### 9-5.Panel wire connecting

- To connect with the panel’s connecting wires, refer to the panel installation manual for detailed information.

## 10. Decorative panel installation

To perform test run without installing the decorative panel, read the chapter “11. Field settings and test run” first. Refer to the installation manual included with the decorative panel. After completing installation of the decorative panel, make sure there is no clearance between the units and the decorative panel.

## 11. Field settings and test run

- (1) Check if the electrical component box covers of the indoor unit and outdoor unit are fastened securely.
- (2) Field settings.

<According to the installation condition, make the field settings using the remote controller after turning on the power supply. Please perform in accordance with “Field settings” of the manual included with the remote controller.>

- Make the settings by changing the “mode number”, “1st coded number” and “2nd coded number”.
- For setting procedure and operating method, refer to the “Field settings” of the manual included with the remote controller. Values marked with ※ and () are the ones when setting the indoor unit separately during group control.
- During remote control, perform input changeover of “Forced OFF” and “ON/OFF” with the remote controller. After start the field settings, select the mode number “12” and set the 1st coded number and the 2nd coded number to “1” and “01” respectively. This is “Forced OFF”.
- Set the 2nd coded number to “02” for “ON/OFF” operation. (Factory setting is “Forced OFF”).

After completing field settings, deliver the “Field settings” and operation manual to the customers for keeping and future reference.

### a.Ceiling height setting

- Select the 2nd coded number corresponding to the ceiling height.
- (Factory setting of the 2nd coded number is “01” which means that means ceiling height is the standard height.)

| Ceiling height in. (m)      |                | Mode number | 1st coded number | 2nd coded number |
|-----------------------------|----------------|-------------|------------------|------------------|
| 07 · 09 · 12 · 15 · 18 · 24 |                |             |                  |                  |
| Lower than 8-3/4 (2.7)      | Standard       | 13(23)      | 0                | 01               |
| 8-3/4~10 (2.7~3)            | High ceiling 1 |             |                  | 02               |
| 10~11-1/2 (3~3.5)           | High ceiling 2 |             |                  | 03               |

### b. Airflow direction range setting

|        | Mode number | 1st coded number | 2nd coded number |
|--------|-------------|------------------|------------------|
| Normal | 13(23)      | 4                | 02               |
| Lower  |             |                  | 03               |

### c. Unit mould proof operation setting

|                               | Mode number | 1st coded number | 2nd coded number |
|-------------------------------|-------------|------------------|------------------|
| Standard                      | 14(24)      | 9                | 02               |
| High humidity district (Note) |             |                  | 03               |

Note): For areas with average humidity over 80%

### d. Settings when installing the optional accessories

- For settings when installing the optional accessories, refer to the installation manual included with the optional accessories.

**e. Setting the air filter cleaning signal**

- The remote controller is equipped with the filter cleaning signal LCD, to display the time to clean the air filter.
- Refer to the table below and change the 2nd coded number in accordance with the room conditions.

| Setting                        | Air filter cleaning signal display | Mode number | 1st coded number | 2nd coded number |
|--------------------------------|------------------------------------|-------------|------------------|------------------|
| Air filter contamination-light | About 2500 hours                   | 10(20)      | 0                | 01               |
| Air filter contamination-heavy | About 1250 hours                   |             |                  | 02               |

**f. Setting of auxiliary heater control (ON/OFF temperature)**

- When an auxiliary heater is installed and controlled by the indoor unit, the heater ON/OFF temperatures, Ton and Toff, can be selected individually by switching the 1st code and 2nd code according to the following table.

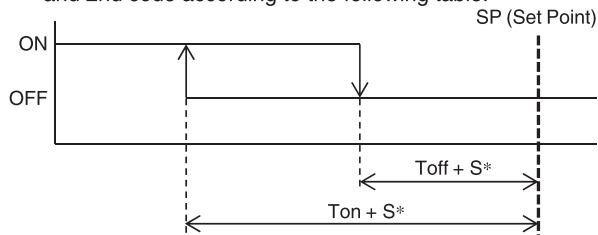

\* "S" value varies automatically based on the room temperature trend.  
°F (°C)

| Symbol | Mode number | 1st coded number | 2nd coded number |                |                |                |                |                |
|--------|-------------|------------------|------------------|----------------|----------------|----------------|----------------|----------------|
|        |             |                  | 01*              | 02             | 03             | 04             | 05             | 06             |
| Ton    | 11 (12)     | 1                | -7.2<br>(-4.0)   | -6.3<br>(-3.5) | -5.4<br>(-3.0) | -4.5<br>(-2.5) | -3.6<br>(-2.0) | -2.7<br>(-1.5) |
| Toff   |             | 2                | -3.6<br>(-2.0)   | -2.7<br>(-1.5) | -1.8<br>(-1.0) | -0.9<br>(-0.5) | 0<br>(0)       | 0.9<br>(0.5)   |

\*Default

Due to 3.6°F (2°C) hysteresis required for reliability, there is a limitation of combination between Ton and Toff below.

|                |              | °F (°C)        |                |                |                |                |                |
|----------------|--------------|----------------|----------------|----------------|----------------|----------------|----------------|
| Toff           | Ton          | -7.2<br>(-4.0) | -6.3<br>(-3.5) | -5.4<br>(-3.0) | -4.5<br>(-2.5) | -3.6<br>(-2.0) | -2.7<br>(-1.5) |
|                | 0.9<br>(0.5) |                | X              | X              | X              | X              | X              |
| 0<br>(0)       |              | X              | X              | X              | X              | X              | N/A            |
| -0.9<br>(-0.5) |              | X              | X              | X              | X              | N/A            | N/A            |
| -1.8<br>(-1.0) |              | X              | X              | X              | N/A            | N/A            | N/A            |
| -2.7<br>(-1.5) |              | X              | X              | N/A            | N/A            | N/A            | N/A            |
| -3.6<br>(-2.0) |              | X              | N/A            | N/A            | N/A            | N/A            | N/A            |

X: Available

**g. Perform test run based on the operation & installation manual of the outdoor unit**

- If something unusual occurs, the operation lamp of the remote controller will flash.  
Check the malfunction code displayed on the LCD to obtain more information about the error.  
For malfunction codes and correspondent explanations, refer to the "Service precautions" of the indoor unit.  
If the following signals are indicated on the display, then the wiring may be improper or the power supply is not turned on. In this case, check again.

| Display                                    | Description   |
|--|---|
| Displaying "Under centralized control"<br> | • Short circuit of the forced-OFF terminals (T1, T2).   |
| Displaying "U3"                            | • Test run has not been completed.  |
| Displaying "U4"<br>Displaying "U5"         | • The outdoor unit is not powered up.<br>• The outdoor unit is not connected to the power wiring.<br>• The transmission wiring and the forced-OFF terminals (T1, T2) are incorrectly connected.<br>• The transmission wiring is disconnected.   |
| No display                                 | • The indoor unit is not powered up.<br>• The indoor unit is not connected to the power wiring.<br>• The remote controller connecting & transmission wiring terminals (F1, F2) and forced-OFF terminals (T1, T2) are incorrectly connected.<br>• The remote controller transmission wiring is disconnected. |

If the test run is performed while the room is under construction; do not operate the unit until construction is complete. Operating the unit in such conditions may result in damage to the unit and surroundings.



## 12. Non-trouble symptoms

### Following symbols are not troubles

Following symptoms have their own causes and are not troubles, continue using this unit.

| Symbols  | Description  |
|--|--|
| Does not operate immediately <ul style="list-style-type: none"> <li>▪ Start immediately after stopping operation.</li> <li>▪ When operation setting mode already changed.</li> </ul> | <ul style="list-style-type: none"> <li>▪ To protect the unit, start it again 3 minutes later after the operation stopped.</li> <li>▪ After powering on, it takes 30 seconds for the fan to start.</li> </ul>   |
| After heating operation starts, the unit doesn't blow off hot air immediately  | <ul style="list-style-type: none"> <li>▪ The air conditioner is preheating, wait 1 ~ 4 minutes.<br/>(It will not blow off hot air until the system reaches a certain temperature.)</li> </ul>  |
| The heating operation suddenly stops and the sound of running water is heard   | <ul style="list-style-type: none"> <li>▪ The outdoor unit is defrosting.<br/>Wait 4 ~ 12 minutes.</li> </ul>   |
| Sonorous   | <ul style="list-style-type: none"> <li>■ Sound of running water               <ul style="list-style-type: none"> <li>▪ This is the sound caused by refrigerant flow in the air conditioner.</li> <li>▪ During cooling or heating operation, this sound can be heard while discharging the water gathered in the air conditioner through the drain pump.</li> <li>▪ The sound caused by refrigerant flow can be heard if other rooms' indoor units are operating even this air conditioner has been stopped.</li> </ul> </li> <li>■ Sound of the wind               <ul style="list-style-type: none"> <li>▪ This is the sound of refrigerant caused by flow change in the air conditioner.</li> </ul> </li> <li>■ Creaking sound               <ul style="list-style-type: none"> <li>▪ Due to temperature changes, the sound is heard during heat expansion and cold contraction.</li> <li>▪ The sound caused by operation of the intake hane.</li> </ul> </li> </ul> |
| Mist comes out of the indoor unit  | <ul style="list-style-type: none"> <li>■ During cooling operation, room air will become cold and form the mist.</li> <li>■ The room air cooled by heat exchanger will form the mist during defrost operation.</li> </ul>   |
| Odor comes out of the indoor unit  | <ul style="list-style-type: none"> <li>■ The odor emitted again by the unit after absorbing the smell of rooms, furniture, cigarettes, etc.<br/>(We recommend you to ask technicians to clean the indoor unit. Consult your dealer. )</li> </ul>   |
| The fan of the indoor unit keeps on running after stopping the operation   | <ul style="list-style-type: none"> <li>■ After the cooling or defrost operation stopped               <ul style="list-style-type: none"> <li>▪ To prevent mildew, the fan of the indoor unit still keeps on running for maximum about 30 minutes.</li> </ul> </li> </ul>   |
| Although the air conditioner has been stopped, the temperature still can be detected or the fan of the indoor units still keeps on running   | <ul style="list-style-type: none"> <li>▪ If other rooms' indoor units are performing heating operation, the moisture can be detected by the stopped air conditioner.<br/>(Refrigerant also flows into the stopped air conditioner.)</li> </ul>   |
| Operation stopped suddenly (operation lamp still lights up)  | <ul style="list-style-type: none"> <li>▪ If the voltage fluctuates greatly, to protect the unit, the air conditioner will stop for maximum 3 minutes and start again.</li> </ul>   |

## Check again

Following symptoms have their own causes and are not troubles, continue using this unit.

| Symbols                                    | Description  |
|--|--|
| Air conditioner does not work              | <ul style="list-style-type: none"><li>▪ Are the breaker switch or fuse disconnected?</li><li>▪ Is the power off?</li><li>▪ Is the timer's setting method proper?</li></ul>   |
| Poor cooling (heating) effect              | <ul style="list-style-type: none"><li>▪ Is the air filter dirty?</li><li>▪ Are the indoor and outdoor units' suction inlet and air outlet blocked?</li><li>▪ Is the set temperature proper?</li><li>▪ Are the doors and windows left opened?</li><li>▪ Are the air flow rate and direction set properly?</li><li>▪ Does the voltage comply with the instructions of the operation &amp; installation manual?</li></ul>   |
| Operation stopped halfway                  | <ul style="list-style-type: none"><li>▪ Is the air filter dirty?</li><li>▪ Are the indoor and outdoor units' suction inlet and air outlet blocked?</li><li>▪ Stop the air conditioner's operation and disconnect the breaker switch. Clean the air filter or clear the obstacles, then start the air conditioner again using the remote controller. After restarting, check the air conditioner's operation using the remote controller. If the lamp flashes, consult your sales agency.</li></ul> |
| Suddenly operate normally during operation | <ul style="list-style-type: none"><li>▪ Thundering or radio also will result in malfunction of the air conditioner. In this case, shut down the power supply and power up again, then start the air conditioner with the remote controller.</li></ul>  |



**DAIKIN**



Our continuing commitment to quality products may mean a change in specifications without notice.

© 2015 **DAIKIN NORTH AMERICA LLC** · Houston, Texas · USA · [www.daikincomfort.com](http://www.daikincomfort.com)



**3P407770-2** (1509) **HTS**