

Engineering Data

RXLQ-TBTJA, 208 / 230 V

RXLQ-TBYDA, 460 V

RXLQ-TBYCA, 575 V

Heat Pump 60 Hz

R-410A



VRV
Aurora Series

1. Basic Information 5

- 1. Features and Benefits 5
- 2. Compatibility 6
- 3. Nomenclature..... 7
 - 3.1 Outdoor Unit 7
 - 3.2 Indoor Unit..... 8

2. Lineup..... 10

- 1. Model Names 10
 - 1.1 Outdoor Units 10
 - 1.2 Indoor Units 11
 - 1.3 Air Treatment Equipment 12
- 2. External Appearance 13
 - 2.1 Outdoor Units 13
 - 2.2 Indoor Units 14
 - 2.3 Air Treatment Equipment 15
- 3. Outdoor Unit Combination 16
- 4. Capacity Range 17
 - 4.1 Connection Ratio..... 17
 - 4.2 Indoor Unit Connection Capacity..... 18

3. Specification 19

- 1. Specifications 19
 - 1.1 RXLQ-TBTJA 19
 - 1.2 RXLQ-TBYDA 21
 - 1.3 RXLQ-TBYCA 23
- 2. Dimensions 25
 - 2.1 RXLQ-TBTJA / TBYDA / TBYCA 25
- 3. Service Space..... 27
 - 3.1 RXLQ-TBTJA / TBYDA / TBYCA 27
- 4. Center of Gravity..... 29
- 5. Foundation Drawing..... 31
- 6. Piping Diagrams..... 32
- 7. Wiring Diagrams 34
- 8. Field Wiring..... 44
- 9. Electrical Characteristics..... 46
- 10. Operation Limits..... 49
- 11. Sound Levels (Reference Data)..... 50
- 12. Accessories..... 53
 - 12.1 Optional Accessories..... 53
- 13. Selection Procedure..... 54
 - 13.1 Selection Procedure 54
- 14. Caution Label..... 60
 - 14.1 RXLQ72-120TBTJA / TBYDA / TBYCA 60
- 15. Caution for Refrigerant Leaks 69

15.1 Introduction.....	69
15.2 Procedure for Checking Maximum Concentration.....	70
17. Safety Devices Setting.....	72
4. Appendix	75
1. Introduction	75
1.1 ED Book List.....	75
1.2 Publication List of Engineering Data for VRV Products.....	76

1. Basic Information

1. Features and Benefits

Engineered for optimized life cycle cost, Daikin's new VRV AURORA™ Heat Pump Series completes the VRV AURORA™ family. VRV AURORA Heat Pumps demonstrate Daikin's technological leadership by offering high seasonal efficiency and capacities across the entire operational range.

- Available in 6, 8, 10 ton single modules and 12, 16, 20 ton multi-module systems
- VRF Industry's first air cooled system that delivers heating down to -22°F (-30°C) as standard
- Daikin's inverter based vapor injection compressor is designed to deliver heating capacity of up to 100% of nominal at 0°F (-18°C), up to 85% of nominal at -13°F (-25°C) and up to 60% of nominal at -22°F (-30°C)
- Refrigerant-cooled efficient and stable inverter board operation, independent of ambient conditions
- Hot gas base pan circuit allows installation without an additional drain pan heater
- Added peace of mind with Auto Changeover ability to back up (auxiliary) heat
- Year round comfort and energy efficiency delivered by combining VRV and VRT technologies
- Designed and optimized for Total Cost of Construction (TCC) and reduced Life Cycle Cost (LCC)
- Corrosion resistant, 1000 hours salt spray tested Daikin PE blue fin heat exchanger
- Ships factory standard with coil guards
- Seamless connection to all VRV M, P and T series indoor units
- Ease commissioning with ability to program settings off site using new configurator tool
- 3-digit 7-segment digital display on the unit for improved and faster configuration, commissioning, and troubleshooting
- Backed by 10 year parts limited warranty and 10 years replacement compressor limited warranty*

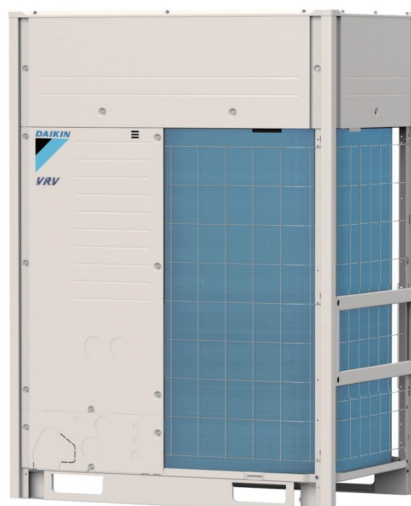

* Complete warranty details available from local distributor or manufacturer's representative or at www.daikincomfort.com

2. Compatibility

208/230 V model	
New model	Current model
RXLQ72TBTJA	RXLQ72TATJA
RXLQ96TBTJA	RXLQ96TATJA
RXLQ120TBTJA	RXLQ120TATJA
RXLQ144TBTJA	RXLQ144TATJA
RXLQ192TBTJA	RXLQ192TATJA
RXLQ240TBTJA	RXLQ240TATJA

460 V model	
New model	Current model
RXLQ72TBYDA	RXLQ72TAYDA
RXLQ96TBYDA	RXLQ96TAYDA
RXLQ120TBYDA	RXLQ120TAYDA
RXLQ144TBYDA	RXLQ144TAYDA
RXLQ192TBYDA	RXLQ192TAYDA
RXLQ240TBYDA	RXLQ240TAYDA

575 V model	
New model	Current model
RXLQ72TBYCA	RXLQ72TAYCA
RXLQ96TBYCA	RXLQ96TAYCA
RXLQ120TBYCA	RXLQ120TAYCA
RXLQ144TBYCA	RXLQ144TAYCA
RXLQ192TBYCA	RXLQ192TAYCA
RXLQ240TBYCA	RXLQ240TAYCA

3. Nomenclature

3.1 Outdoor Unit

Outdoor Unit

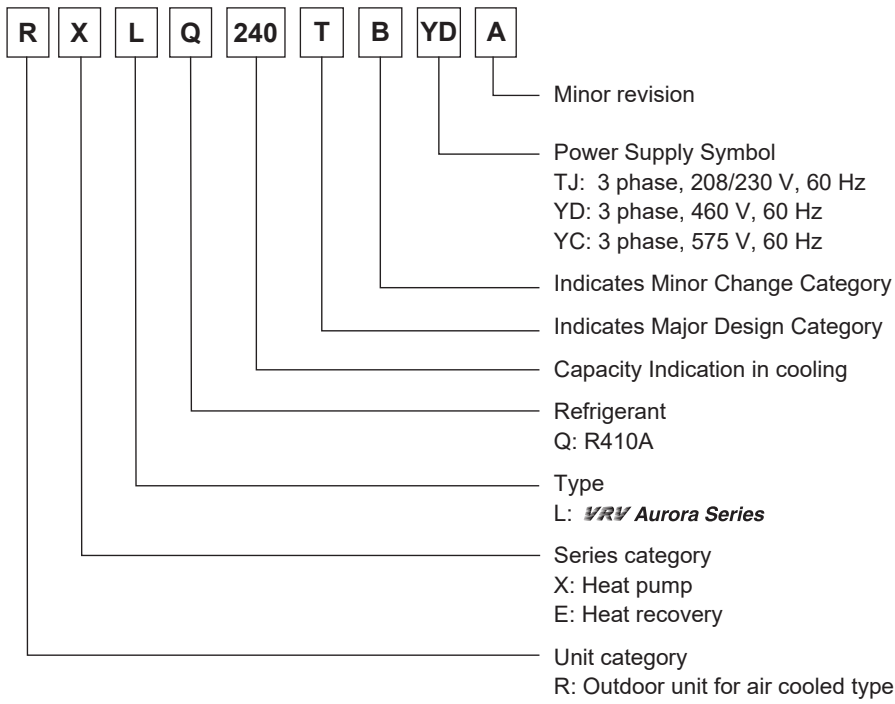

3.2 Indoor Unit

Indoor Unit

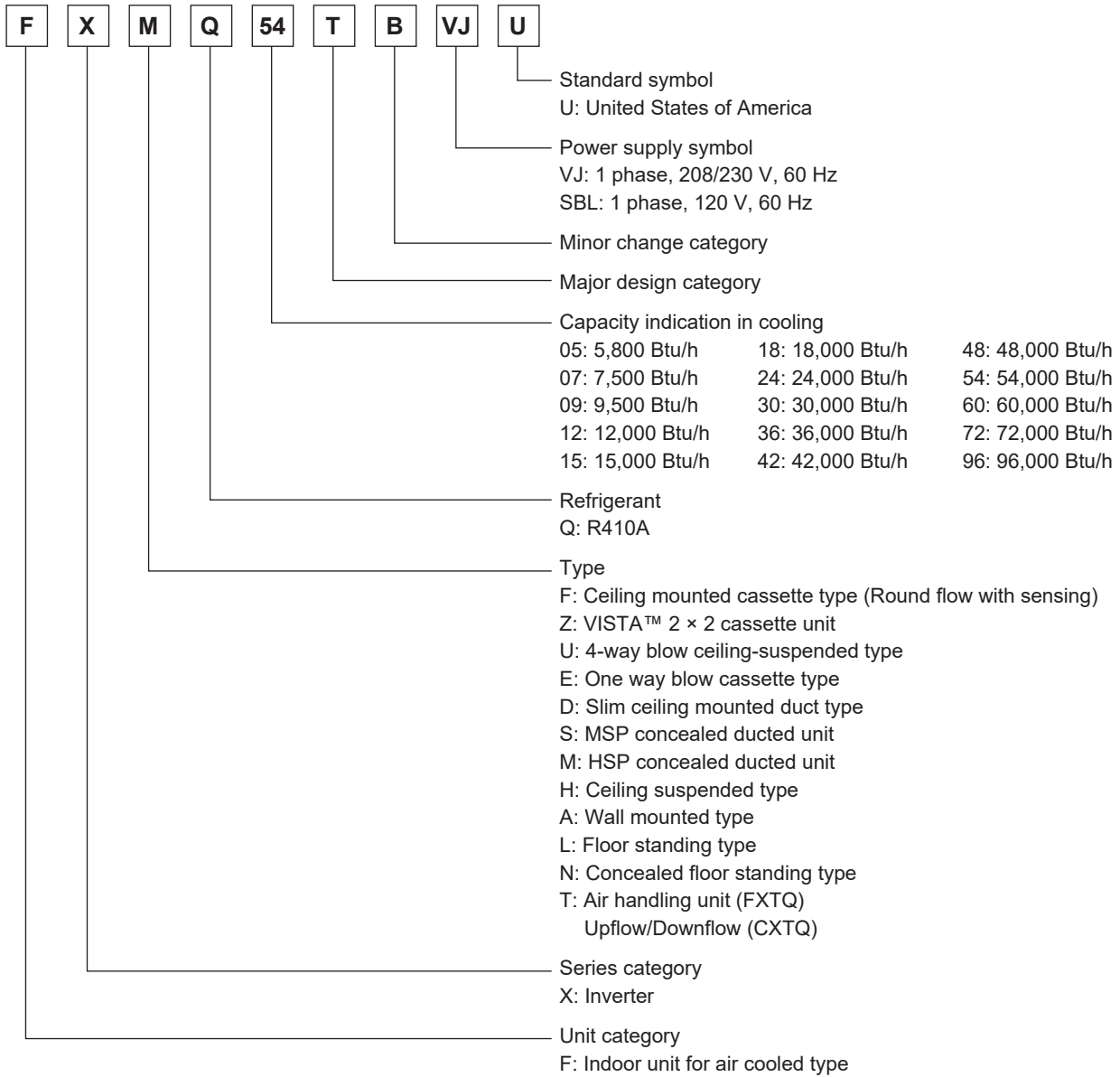

Air Treatment Equipment

Outdoor Air Processing Unit

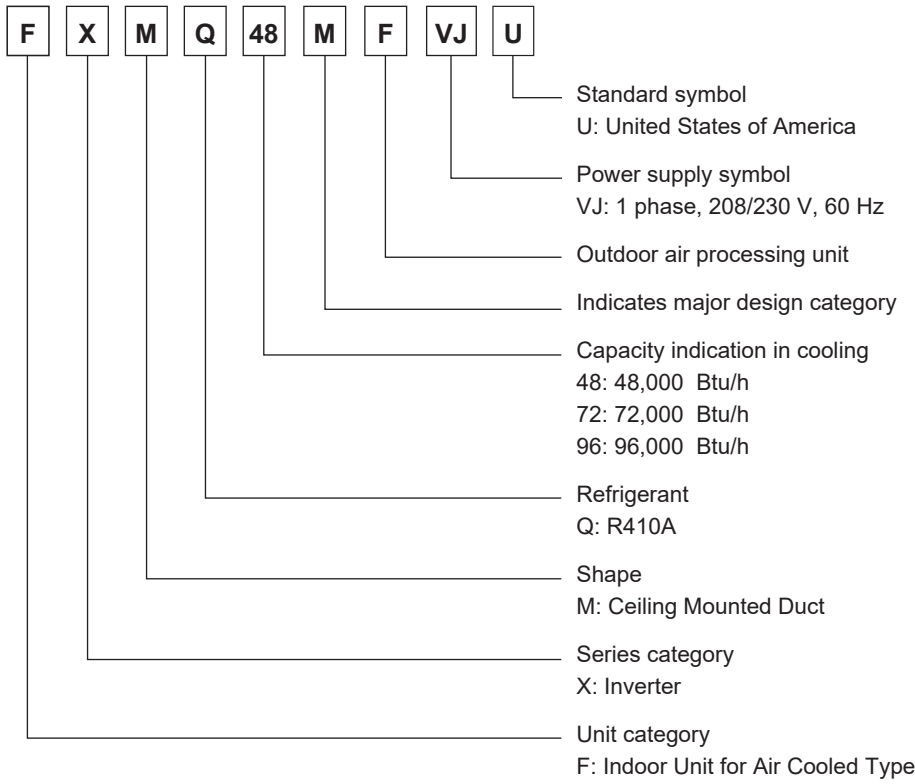

Energy Recovery Ventilator (VAM series)

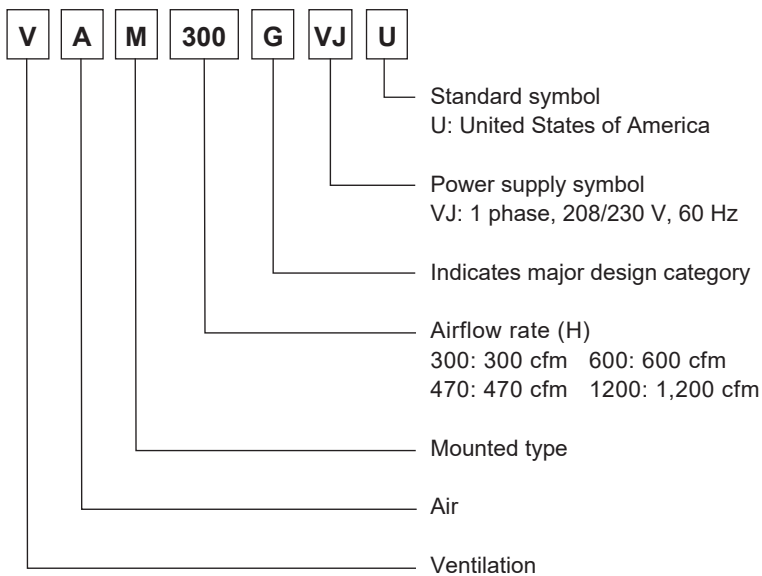

2. Lineup

1. Model Names

1.1 Outdoor Units

Capacity Range			6 ton	8 ton	10 ton	12 ton	16 ton	20 ton	Power Supply, Standard
Capacity Index			72	96	120	144	192	240	
Heat Pump	208/230 V	RXLQ-	72TB	96TB	120TB	144TB	192TB	240TB	TJA
	460 V	RXLQ-	72TB	96TB	120TB	144TB	192TB	240TB	YDA
	575 V	RXLQ-	72TB	96TB	120TB	144TB	192TB	240TB	YCA

TJ : 3 phase, 208/230 V, 60 Hz

YD : 3 phase, 460 V, 60 Hz

YC : 3 phase, 575 V, 60 Hz

A : Minor revision

Heat Pump 208/230 V

Model name	RXLQ72TBTJA	RXLQ96TBTJA	RXLQ120TBTJA
Outdoor unit 1	RXLQ72TBTJA	RXLQ96TBTJA	RXLQ120TBTJA

Model name	RXLQ144TBTJA	RXLQ192TBTJA	RXLQ240TBTJA
Outdoor unit 1	RXLQ72TBTJA	RXLQ96TBTJA	RXLQ120TBTJA
Outdoor unit 2	RXLQ72TBTJA	RXLQ96TBTJA	RXLQ120TBTJA

Heat Pump 460 V

Model name	RXLQ72TBYDA	RXLQ96TBYDA	RXLQ120TBYDA
Outdoor unit 1	RXLQ72TBYDA	RXLQ96TBYDA	RXLQ120TBYDA

Model name	RXLQ144TBYDA	RXLQ192TBYDA	RXLQ240TBYDA
Outdoor unit 1	RXLQ72TBYDA	RXLQ96TBYDA	RXLQ120TBYDA
Outdoor unit 2	RXLQ72TBYDA	RXLQ96TBYDA	RXLQ120TBYDA

Heat Pump 575 V

Model name	RXLQ72TBYCA	RXLQ96TBYCA	RXLQ120TBYCA
Outdoor unit 1	RXLQ72TBYCA	RXLQ96TBYCA	RXLQ120TBYCA

Model name	RXLQ144TBYCA	RXLQ192TBYCA	RXLQ240TBYCA
Outdoor unit 1	RXLQ72TBYCA	RXLQ96TBYCA	RXLQ120TBYCA
Outdoor unit 2	RXLQ72TBYCA	RXLQ96TBYCA	RXLQ120TBYCA

1.2 Indoor Units

Capacity Range		0.5 ton	0.6 ton	0.8 ton	1 ton	1.25 ton	1.5 ton		2 ton	2.5 ton	3 ton	3.5 ton	4 ton	4.5 ton	5 ton	6 ton	8 ton	Power Supply, Standard
Capacity Index		5.8	7.5	9.5	12	15	18	20	24	30	36	42	48	54	60	72	96	
Ceiling mounted cassette (Round flow with sensing) type	FXFQ	—	07AA	09AA	12AA	15AA	18AA	—	24AA	30AA	36AA	—	48AA	54AA	—	—	—	VJU
VISTA™ 2 × 2 cassette unit	FXZQ	05TB	07TB	09TB	12TB	15TB	18TB	—	—	—	—	—	—	—	—	—	—	
4-way blow ceiling-suspended type	FXUQ	—	—	—	—	—	—	18PA	24PA	30PA	36PA	—	—	—	—	—	—	
One way blow cassette type	FXEQ	—	07P	09P	12P	15P	18P	—	24P	—	—	—	—	—	—	—	—	
Slim ceiling mounted duct type	FXDQ	—	07M	09M	12M	—	18M	—	24M	—	—	—	—	—	—	—	—	
MSP concealed ducted unit	FXSQ	05TB	07TB	09TB	12TB	15TB	18TB	—	24TB	30TB	36TB	—	48TB	54TB	—	—	—	
HSP concealed ducted unit	FXMQ	—	—	—	—	15TB	18TB	—	24TB	30TB	36TB	—	48TB	54TB	—	—	—	
Ceiling mounted duct type	FXMQ	—	—	—	—	—	—	—	—	—	—	—	—	—	—	72TA	96TA	
Ceiling suspended type	FXHQ	—	—	—	12M	—	—	—	24M	—	36M	—	—	—	—	—	—	
Wall mounted type	FXAQ	—	07P	09P	12P	—	18P	—	24P	—	—	—	—	—	—	—	—	
Floor standing type	FXLQ	—	07M	09M	12M	—	18M	—	24M	—	—	—	—	—	—	—	—	
Concealed floor standing type	FXNQ	—	07M	09M	12M	—	18M	—	24M	—	—	—	—	—	—	—	—	
Air handling unit	FXTQ	—	—	09TB	12TB	—	18TB	—	24TB	30TB	36TB	42TB	48TB	54TB	60TB	—	—	
		—	—	09TB	12TB	—	18TB	—	24TB	30TB	36TB	42TB	48TB	54TB	60TB	—	—	VJUD
Cased coil unit	CXTQ	—	—	—	—	—	—	—	24TA	—	36TA	—	48TA	—	60TA	—	—	SBLU

2. Lineup

1.3 Air Treatment Equipment

Outdoor Air Processing Unit

Series	Model name			Power supply, Standard
FXMQ	48MF	72MF	96MF	VJU

VJ: 1 phase, 208 / 230 V, 60 Hz
 U(VJU): Standard symbol

Energy Recovery Ventilator (VAM series)

Series	Model name				Power supply, Standard
VAM	300G	470G	600G	1200G	VJU

VJ: 1 phase, 208 / 230 V, 60 Hz
 U(VJU): Standard symbol

2. External Appearance

2.1 Outdoor Units

Single Outdoor Unit

<p>RXLQ72TBTJA RXLQ96TBTJA RXLQ120TBTJA</p>	<p>RXLQ72TBYDA RXLQ96TBYDA RXLQ120TBYDA</p>	<p>RXLQ72TBYCA RXLQ96TBYCA RXLQ120TBYCA</p>
<div style="text-align: center;">  <p>6, 8, 10 ton</p> </div>		

2. Lineup

Double Outdoor Units

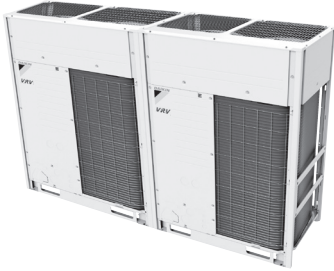
<p>RXLQ144TBTJA RXLQ192TBTJA RXLQ240TBTJA</p>	<p>RXLQ144TBYDA RXLQ192TBYDA RXLQ240TBYDA</p>	<p>RXLQ144TBYCA RXLQ192TBYCA RXLQ240TBYCA</p>
<div style="text-align: center;">  <p>12, 16, 20 ton</p> </div>		

2.2 Indoor Units

<p>Ceiling mounted cassette (Round flow with sensing) type</p> <p>FXFQ-AA</p>  <p>Shown with BYCQ54EEFU</p>	<p>Ceiling mounted duct type</p> <p>FXMQ-TA</p> 
<p>VISTA™ 2 × 2 cassette unit</p> <p>FXZQ-TB</p> 	<p>Ceiling suspended type</p> <p>FXHQ-M</p> 
<p>4-way blow ceiling-suspended type</p> <p>FXUQ-PA</p> 	<p>Wall mounted type</p> <p>FXAQ-P</p> 
<p>One way blow cassette type</p> <p>FXEQ-P</p> 	<p>Floor standing type</p> <p>FXLQ-M</p> 
<p>Slim ceiling mounted duct type</p> <p>FXDQ-M</p> 	<p>Concealed floor standing type</p> <p>FXNQ-M</p> 
<p>MSP concealed ducted unit</p> <p>FXSQ-TB</p> 	<p>Air handling unit</p> <p>FXTQ-TB</p> 
<p>HSP concealed ducted unit</p> <p>FXMQ-TB</p> 	<p>Cased coil unit</p> <p>CXTQ-TA</p> 

2.3 Air Treatment Equipment

Outdoor air processing unit

FXMQ-MF



Energy recovery ventilator
(VAM series)

VAM-G

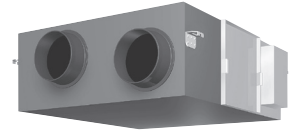

3. Outdoor Unit Combination

Model name	System capacity			Number of units	Module			Outdoor Unit Multi Connection Piping Kit ★1
	Ton	HP	kW		72	96	120	
RXLQ72TBTJA RXLQ72TBYDA RXLQ72TBYCA	6	7.5	21.1	1	●			—
RXLQ96TBTJA RXLQ96TBYDA RXLQ96TBYCA	8	10.0	28.1	1		●		
RXLQ120TBTJA RXLQ120TBYDA RXLQ120TBYCA	10	12.5	35.2	1			●	
RXLQ144TBTJA RXLQ144TBYDA RXLQ144TBYCA	12	15.0	42.2	2	●●			BHFP22P100U BHFP22P100UA
RXLQ192TBTJA RXLQ192TBYDA RXLQ192TBYCA	16	20.0	56.3	2		●●		
RXLQ240TBTJA RXLQ240TBYDA RXLQ240TBYCA	20	25.0	70.3	2			●●	

Note:

★1. For multiple connection, the outdoor unit multi connection piping kit (separately sold) is required.

4. Capacity Range

4.1 Connection Ratio

$$\text{Connection ratio} = \frac{\text{Total capacity index of the indoor units}}{\text{Capacity index of the outdoor units}}$$

Type	Min. connection ratio	Max. connection ratio				
		Types of connected indoor units			Type of connected air treatment equipment	
		When using only FXDQ, FXMQ-TB, FXAQ, FXSQ07-54T	When using at least one FXFQ07/09, FXZQ05T, FXSQ05T	Other indoor unit models	FXMQ-MF	
When FXMQ-MF is only connected	When FXMQ-MF and indoor units are connected					
Single outdoor unit	70%	200% *1	180% *1	200% *1	100%	100% *2
Double outdoor units			160% *1	160% *1		

Notes:

- *1. If the operational capacity of indoor units is more than 130%, low airflow operation is enforced in all the indoor units. Field setting now exists to configure this situation. For cooling and heating mode – see below.
- *2. When outdoor-air processing units (FXMQ-MF) and standard indoor units are connected, the total connection capacity of the outdoor-air processing units (FXMQ-MF) must not exceed 30% of the capacity index of the outdoor units. And the connection ratio must not exceed 100%.

Indoor unit fan tap setting

Indoor units fan speed limitation related to connection capacity and outdoor air temperature for energy saving.

Default value = 0

Value	Indoor unit fan tap setting
0	Fan speed is limited to L tap when indoor units capacity ≥ 130%.
1	In heating mode, fan speed is limited to L tap when indoor units capacity ≥ 130%.
2	Fan speed follows the setting of the remote controllers (not limited by indoor units connection capacity).
3	Fan speed is limited to L tap when outdoor air temperature goes down to below 85.1°F (29.5°C) and indoor air temperature is in condition A (*1). It returns to remote controller setting when outdoor air temperature goes up to over 90.5 °F (32.5°C) or indoor air temperature is in condition B (*2).
4	Fan speed is limited to L tap when outdoor air temperature goes down to below 74.3°F (23.5°C) and indoor air temperature is in condition A (*1). It returns to remote controller setting when outdoor air temperature goes up to over 79.7°F (26.5°C) or indoor air temperature is in condition B (*2).
5	Fan speed is limited to L tap when outdoor air temperature goes down to below 66.7°F (19.3°C) and indoor air temperature is in condition A (*1). It returns to remote controller setting when outdoor air temperature goes up to over 72.1°F (22.3°C) or indoor air temperature is in condition B (*2).
6	Fan speed is limited to L tap when outdoor air temperature goes down to below 85.1°F (29.5°C). It returns to remote controller setting when outdoor air temperature goes up to over 90.5°F (32.5°C).
7	Fan speed is limited to L tap when outdoor air temperature goes down to below 74.3°F (23.5°C). It returns to remote controller setting when outdoor air temperature goes up to over 79.7°F (26.5°C).
8	Fan speed is limited to L tap when outdoor air temperature goes down to below 66.7°F (19.3°C). It returns to remote controller setting when outdoor air temperature goes up to over 72.1°F (22.3°C).

- *1. Indoor condition A: Temperature difference (indoor air temperature – set temperature) is more than –2.7°F (–1.5°C) and less than 5.4°F (3°C).
- *2. Indoor condition B: Temperature difference (indoor air temperature – set temperature) is –2.7°F (–1.5°C) or less, or 5.4°F (3°C) or more.

4.2 Indoor Unit Connection Capacity

Type	Ton	Capacity index	Model name	Combination	Outdoor unit multi connection piping kit *1	Total capacity index of connectable indoor units *2	Maximum number of connectable indoor units
Single outdoor unit	6	72	RXLQ72TB	RXLQ72TB	—	51 to 93 (144)	12
	8	96	RXLQ96TB	RXLQ96TB		68 to 124 (192)	16
	10	120	RXLQ120TB	RXLQ120TB		84 to 156 (240)	20
Double outdoor units	12	144	RXLQ144TB	RXLQ72TB+RXLQ72TB	BHFP22P100U BHFP22P100UA	101 to 187 (230)	25
	16	192	RXLQ192TB	RXLQ96TB+RXLQ96TB		135 to 249 (307)	33
	20	240	RXLQ240TB	RXLQ120TB+RXLQ120TB		168 to 312 (384)	41

Note:

*1. For multiple connection, the outdoor unit multi connection piping kit (separately sold) is required.

*2. Values inside brackets are based on connection of indoor units rated at maximum capacity, 200% for single outdoor unit, 160% for double outdoor units.

3. Specification

1. Specifications

1.1 RXLQ-TBTJA

RXLQ72 / 96 / 120TBTJA

Outdoor Unit Model No.	RXLQ72TBTJA	RXLQ96TBTJA	RXLQ120TBTJA
Power Supply	3 phase, 60Hz, 208/230V	3 phase, 60Hz, 208/230V	3 phase, 60Hz, 208/230V
★1 Cooling Capacity	Nominal	72,000 (21.1)	96,000 (28.1)
	Rated	69,000 (20.2)	92,000 (27.0)
		81,000 (23.7)	108,000 (31.7)
★2 Heating Capacity	Nominal	69,000 (20.2)	92,000 (27.0)
	Rated	69,000 (20.2)	92,000 (27.0)
		81,000 (23.7)	108,000 (31.7)
Casing Color	Ivory White (5Y7.5/1)	Ivory White (5Y7.5/1)	Ivory White (5Y7.5/1)
Dimensions: (H x W x D)	66-11/16 x 48-7/8 x 30-3/16 (1694 x 1242 x 767)	66-11/16 x 48-7/8 x 30-3/16 (1694 x 1242 x 767)	66-11/16 x 48-7/8 x 30-3/16 (1694 x 1242 x 767)
Heat Exchanger	Cross Fin Coil	Cross Fin Coil	Cross Fin Coil
Compressor	Type	Hermetically Sealed Scroll Type	Hermetically Sealed Scroll Type
	Displacement	12.9	16.5
	Number of Revolutions	3804	3114
	Motor Output x Number of Units	4.0 x 1	4.8 x 1
Fan	Starting Method	Soft Start	Soft Start
	Type	Propeller Fan	Propeller Fan
	Motor Output	0.8 x 2	0.8 x 2
	Airflow Rate	7283 (206)	7989 (226)
Connecting Pipes	Drive	Direct Drive	Direct Drive
	Liquid Pipe	φ3/8 (9.5) C1220T (Brazing Connection)	φ3/8 (9.5) C1220T (Brazing Connection)
	Gas Pipe	φ3/4 (19.1) C1220T (Brazing Connection)	φ1-1/8 (28.6) C1220T (Brazing Connection)
Weight	727 (330)	793 (360)	793 (360)
Sound Pressure Level (Reference Data)	60 (65 ★3)	61 (67 ★3)	63.5 (67 ★3)
Sound Power Level (Reference Data)	79	80.5	84.5
Safety Devices	High Pressure Switch	High Pressure Switch	High Pressure Switch
	Fan Driver Overload Protector	Fan Driver Overload Protector	Fan Driver Overload Protector
	Overcurrent Fuse	Overcurrent Fuse	Overcurrent Fuse
	Inverter Overload Protector, Leak Detecting Device	Inverter Overload Protector, Leak Detecting Device	Inverter Overload Protector, Leak Detecting Device
Defrost Method	Deicer	Deicer	Deicer
Capacity Control	11 - 100	13 - 100	12 - 100
Refrigerant Name	R410A	R410A	R410A
Charge	25.8 (11.7)	25.8 (11.7)	25.8 (11.7)
Control	Electronic Expansion Valve	Electronic Expansion Valve	Electronic Expansion Valve
Standard Accessories	Installation Manual	Installation Manual	Installation Manual
	Operation Manual	Operation Manual	Operation Manual
	Connection Pipes, Clamps	Connection Pipes, Clamps	Connection Pipes, Clamps

Notes
 ★1 Indoor temp.: 80°FDB (26.7°CDB) / Outdoor temp.: 35°FDB (3.0°CDB) / Rated capacity is certified under AHRI standard 1200.
 ★2 Indoor temp.: 70°FDB (21.1°CDB) / Outdoor temp.: 47°FDB (8.3°CDB) / Rated capacity is certified under AHRI standard 1200.
 ★3 Sound pressure level may increase during heating operation at ambient temps below 41°F (5°C) value in parenthesis is the max sound pressure at those conditions.

RXLQ144 / 192 / 240TBTJA

Outdoor Unit Model No.	RXLQ144TBTJA	RXLQ192TBTJA	RXLQ240TBTJA
Unit Combination	RXLQ72TBTJA RXLQ96TBTJA RXLQ96TBTJA	RXLQ96TBTJA RXLQ96TBTJA RXLQ96TBTJA	RXLQ120TBTJA RXLQ120TBTJA RXLQ120TBTJA
Power Supply	3 phase, 60Hz, 208/230V	3 phase, 60Hz, 208/230V	3 phase, 60Hz, 208/230V
★1 Cooling Capacity	Btu/h (kW)	Nominal 144,000 (42.2) Rated 138,000 (40.4)	Nominal 192,000 (56.3) Rated 184,000 (53.9)
	Btu/h (kW)	Nominal 162,000 (47.5) Rated 138,000 (40.4)	Nominal 216,000 (63.3) Rated 184,000 (53.9)
★2 Heating Capacity	Btu/h (kW)	Nominal 138,000 (40.4) Rated 162,000 (47.5)	Nominal 184,000 (53.9) Rated 216,000 (63.3)
	Btu/h (kW)	Nominal 162,000 (47.5) Rated 138,000 (40.4)	Nominal 216,000 (63.3) Rated 184,000 (53.9)
Casing Color	Kory White (57.5/1)		
Dimensions: (H x W x D)	66-11/16 x 48-7/8 x 30-3/16 + 66-11/16 x 48-7/8 x 30-3/16 (1694 x 1242 x 767 + 1694 x 1242 x 767)	66-11/16 x 48-7/8 x 30-3/16 + 66-11/16 x 48-7/8 x 30-3/16 (1694 x 1242 x 767 + 1694 x 1242 x 767)	66-11/16 x 48-7/8 x 30-3/16 + 66-11/16 x 48-7/8 x 30-3/16 (1694 x 1242 x 767 + 1694 x 1242 x 767)
Heat Exchanger	Cross Fin Coil		
Type	Hermetically Sealed Scroll Type		
Displacement	17.0 + 17.0		
Number of Revolutions	3204 + 3204		
Motor Output x Number of units	4.1 x 1 + 4.1 x 1		
Starting Method	Soft Start		
Type	Propeller Fan		
Motor Output	(0.8 x 2) x 2		
Airflow Rate	7283 + 7283 (206 + 206)		
Drive	Direct Drive		
Liquid Pipe	φ5/8 (12.7) C1220T (Braze Connection)		
Gas Pipe	φ1-7/8 (28.6) C1220T (Braze Connection)		
Weight	793 + 727 (330 + 330)		
Sound pressure level (Reference data)	63 (68 ★3)		
Sound power level (Reference data)	82		
Safety Devices	High Pressure Switch, Fan Driver Overload Protector, Overcurrent Fuse, Inverter Overload Protector, Leak Detecting Device	High Pressure Switch, Fan Driver Overload Protector, Overcurrent Fuse, Inverter Overload Protector, Leak Detecting Device	High Pressure Switch, Fan Driver Overload Protector, Overcurrent Fuse, Inverter Overload Protector, Leak Detecting Device
Defrost Method	Deicer		
Capacity Control	6 - 100		
Refrigerant Name	R410A		
Charge Control	25.8 + 25.8 (11.7 + 11.7)		
Standard Accessories	Installation Manual, Operation Manual, Connection Pipes, Clamps	Installation Manual, Operation Manual, Connection Pipes, Clamps	Installation Manual, Operation Manual, Connection Pipes, Clamps

Notes
 ★1 Indoor temp.: 80°FDB (26.7°CDB) / 67°FIB (19.4°CIB) / Outdoor temp.: 95°FDB (35.0°CDB) / Rated capacity is certified under AHRI standard 1200.
 ★2 Indoor temp.: 70°FDB (21.1°CDB) / 47°FIB (8.3°CIB) / Outdoor temp.: 43°FDB (6.1°CDB) / Rated capacity is certified under AHRI standard 1200.
 ★3 Sound pressure level may increase during heating operation at ambient temps below 41°F (5°C) value in parenthesis is the max sound pressure at those conditions.

1.2 RXLQ-TBYDA

RXLQ72 / 96 / 120TBYDA

Outdoor Unit Model No.	RXLQ72TBYDA	RXLQ96TBYDA	RXLQ120TBYDA
Power Supply	3 phase, 60Hz, 460V	3 phase, 60Hz, 460V	3 phase, 60Hz, 460V
★1 Cooling Capacity	Nominal	72,000 (21.1)	96,000 (28.1)
	Rated	69,000 (20.2)	92,000 (27.0)
			119,000 (34.9)
★2 Heating Capacity	Nominal	81,000 (23.7)	108,000 (31.7)
	Rated	69,000 (20.2)	92,000 (27.0)
			135,000 (39.6)
Casing Color	Ivory White (5Y7.5/1)	Ivory White (5Y7.5/1)	Ivory White (5Y7.5/1)
Dimensions: (H x W x D)	66-11/16 x 48-7/8 x 30-3/16 (1694 x 1242 x 767)	66-11/16 x 48-7/8 x 30-3/16 (1694 x 1242 x 767)	66-11/16 x 48-7/8 x 30-3/16 (1694 x 1242 x 767)
Heat Exchanger	Cross Fin Coil	Cross Fin Coil	Cross Fin Coil
Compressor	Type	Hermetically Sealed Scroll Type	Hermetically Sealed Scroll Type
	Displacement	12.9	16.5
	Number of Revolutions	3804	3114
	Motor Output x Number of Units	4.0 x 1	4.8 x 1
Fan	Starting Method	Soft Start	Soft Start
	Type	Propeller Fan	Propeller Fan
	Motor Output	0.6 x 2	0.6 x 2
	Airflow Rate	7283 (206)	7989 (226)
Connecting Pipes	Drive	Direct Drive	Direct Drive
	Liquid Pipe	φ3/8 (9.5) C1220T (Brazing Connection)	φ3/8 (9.5) C1220T (Brazing Connection)
	Gas Pipe	φ3/4 (19.1) C1220T (Brazing Connection)	φ1-1/8 (28.6) C1220T (Brazing Connection)
Weight	727 (330)	793 (360)	793 (360)
Sound Pressure Level (Reference Data)	60 (65 ★3)	61 (67 ★3)	63.5 (67 ★3)
Sound Power Level (Reference Data)	79	80.5	84.5
Safety Devices	High Pressure Switch	High Pressure Switch	High Pressure Switch
	Fan Driver Overload Protector	Fan Driver Overload Protector	Fan Driver Overload Protector
	Overcurrent Fuse	Overcurrent Fuse	Overcurrent Fuse
	Inverter Overload Protector, Leak Detecting Device	Inverter Overload Protector, Leak Detecting Device	Inverter Overload Protector, Leak Detecting Device
Defrost Method	Deicer	Deicer	Deicer
Capacity Control	11 - 100	13 - 100	12 - 100
Refrigerant Name	R410A	R410A	R410A
Charge	25.8 (11.7)	25.8 (11.7)	25.8 (11.7)
Control	Electronic Expansion Valve	Electronic Expansion Valve	Electronic Expansion Valve
Standard Accessories	Installation Manual	Installation Manual	Installation Manual
	Operation Manual	Operation Manual	Operation Manual
	Connection Pipes, Clamps	Connection Pipes, Clamps	Connection Pipes, Clamps

Notes
 ★1 Indoor temp.: 80°FDB (26.7°CDB) / Outdoor temp.: 35°FDB (35.0°CDB) / Rated capacity is certified under AHRI standard 1200.
 ★2 Indoor temp.: 70°FDB (21.1°CDB) / Outdoor temp.: 47°FDB (8.3°CDB) / Rated capacity is certified under AHRI standard 1200.
 ★3 Sound pressure level may increase during heating operation at ambient temps below 41°F (5°C) value in parenthesis is the max sound pressure at those conditions.

RXLQ144 / 192 / 240TBYDA

Outdoor Unit Model No.	RXLQ144TBYDA	RXLQ192TBYDA	RXLQ240TBYDA	
Unit Combination	RXLQ72TBYDA RXLQ96TBYDA RXLQ120TBYDA	RXLQ96TBYDA RXLQ120TBYDA	RXLQ120TBYDA	
Power Supply	3 phase, 60Hz, 460V	3 phase, 60Hz, 460V	3 phase, 60Hz, 460V	
★1 Cooling Capacity	Btu/h (kW)	Nominal 144,000 (42.2) Rated 138,000 (40.4)	Nominal 192,000 (56.3) Rated 184,000 (53.9)	Nominal 238,000 (69.8) Rated 228,000 (66.8)
	Btu/h (kW)	Nominal 162,000 (47.5) Rated 138,000 (40.4)	Nominal 216,000 (63.3) Rated 184,000 (53.9)	Nominal 270,000 (79.1) Rated 228,000 (66.8)
★2 Heating Capacity	Btu/h (kW)	Nominal 138,000 (40.4) Rated 162,000 (47.5)	Nominal 184,000 (53.9) Rated 216,000 (63.3)	Nominal 228,000 (66.8) Rated 270,000 (79.1)
Casing Color	Mory White (57.5/1)	Mory White (57.5/1)	Mory White (57.5/1)	
Dimensions: (H x W x D)	66-11/16 x 48-7/8 x 30-3/16 + 66-11/16 x 48-7/8 x 30-3/16 (1694 x 1242 x 767 + 1694 x 1242 x 767)	66-11/16 x 48-7/8 x 30-3/16 + 66-11/16 x 48-7/8 x 30-3/16 (1694 x 1242 x 767 + 1694 x 1242 x 767)	66-11/16 x 48-7/8 x 30-3/16 + 66-11/16 x 48-7/8 x 30-3/16 (1694 x 1242 x 767 + 1694 x 1242 x 767)	
Heat Exchanger	Cross Fin Coil	Cross Fin Coil	Cross Fin Coil	
Type	Hermetically Sealed Scroll Type	Hermetically Sealed Scroll Type	Hermetically Sealed Scroll Type	
Displacement	13.2 + 13.2	17.0 + 17.0	21.2 + 21.2	
Number of Revolutions	3894 + 3894	3204 + 3204	4002 + 4002	
Motor Output x Number of units	4.1 x 1 + 4.1 x 1	4.9 x 1 + 4.9 x 1	6.1 x 1 + 6.1 x 1	
Starting Method	Soft Start	Soft Start	Soft Start	
Type	Propeller Fan	Propeller Fan	Propeller Fan	
Motor Output	(0.6 x 2) x 2	(0.6 x 2) x 2	(0.6 x 2) x 2	
Airflow Rate	7283 + 7283 (206 + 206)	7989 + 7989 (226 + 226)	8806 + 8806 (249 + 249)	
Drive	Direct Drive	Direct Drive	Direct Drive	
Liquid Pipe	φ1/2 (12.7) C1220T (Brazing Connection)	φ5/8 (15.9) C1220T (Brazing Connection)	φ5/8 (15.9) C1220T (Brazing Connection)	
Gas Pipe	φ1-7/8 (28.6) C1220T (Brazing Connection)	φ1-7/8 (28.6) C1220T (Brazing Connection)	φ1-3/8 (34.9) C1220T (Brazing Connection)	
Weight	lbs (kg) 727 + 727 (330 + 330)	793 + 793 (360 + 360)	793 + 793 (360 + 360)	
Sound pressure level (Reference data)	dB(A) 63 (68 ★3)	64 (70 ★3)	67 (70 ★3)	
Sound power level (Reference data)	dB	83.5	87.5	
Safety Devices	High Pressure Switch, Fan Driver Overload Protector, Overcurrent Fuse, Inverter Overload Protector, Leak Detecting Device	High Pressure Switch, Fan Driver Overload Protector, Overcurrent Fuse, Inverter Overload Protector, Leak Detecting Device	High Pressure Switch, Fan Driver Overload Protector, Overcurrent Fuse, Inverter Overload Protector, Leak Detecting Device	
Defrost Method	Deicer	Deicer	Deicer	
Capacity Control	% 5 - 100	6 - 100	6 - 100	
Refrigerant Name	R410A	R410A	R410A	
Charge Control	lbs (kg) 25.8 + 25.8 (11.7 + 11.7)	25.8 + 25.8 (11.7 + 11.7)	25.8 + 25.8 (11.7 + 11.7)	
Standard Accessories	Installation Manual, Operation Manual, Connection Pipes, Clamps	Installation Manual, Operation Manual, Connection Pipes, Clamps	Installation Manual, Operation Manual, Connection Pipes, Clamps	

Notes
 ★1 Indoor temp.: 80°FDB (26.7°CDB) / 67°FIB (19.4°CIB) / Outdoor temp.: 95°FDB (35.0°CDB) / Rated capacity is certified under AHRI standard 1200.
 ★2 Indoor temp.: 70°FDB (21.1°CDB) / 47°FIB (8.3°CIB) / Outdoor temp.: 43°FDB (6.1°CDB) / Rated capacity is certified under AHRI standard 1200.
 ★3 Sound pressure level may increase during heating operation at ambient temps below 41°F (5°C) value in parenthesis is the max sound pressure at those conditions.

1.3 RXLQ-TBYCA

RXLQ72 / 96 / 120TBYCA

Outdoor Unit Model No.	RXLQ72TBYCA	RXLQ96TBYCA	RXLQ120TBYCA
Power Supply	3 phase, 60Hz, 575V	3 phase, 60Hz, 575V	3 phase, 60Hz, 575V
★1 Cooling Capacity	Nominal	72,000 (21.1)	96,000 (28.1)
	Rated	69,000 (20.2)	92,000 (27.0)
		81,000 (23.7)	108,000 (31.7)
★2 Heating Capacity	Nominal	69,000 (20.2)	92,000 (27.0)
	Rated	69,000 (20.2)	92,000 (27.0)
		81,000 (23.7)	108,000 (31.7)
Casing Color	Ivory White (5Y7.5/1)	Ivory White (5Y7.5/1)	Ivory White (5Y7.5/1)
Dimensions: (H x W x D)	66-11/16 x 48-7/8 x 30-3/16 (1694 x 1242 x 767)	66-11/16 x 48-7/8 x 30-3/16 (1694 x 1242 x 767)	66-11/16 x 48-7/8 x 30-3/16 (1694 x 1242 x 767)
Heat Exchanger	Cross Fin Coil	Cross Fin Coil	Cross Fin Coil
Compressor	Type	Hermetically Sealed Scroll Type	Hermetically Sealed Scroll Type
	Displacement	12.9	16.5
	Number of Revolutions	3804	3114
	Motor Output x Number of Units	4.0 x 1	4.8 x 1
Fan	Starting Method	Soft Start	Soft Start
	Type	Propeller Fan	Propeller Fan
	Motor Output	0.7 x 2	0.7 x 2
Airflow Rate	7283 (206)	7989 (226)	8806 (249)
Drive	Direct Drive	Direct Drive	Direct Drive
Connecting Pipes	Liquid Pipe	φ3/8 (9.5) C1220T (Braze Connection)	φ3/8 (9.5) C1220T (Braze Connection)
	Gas Pipe	φ3/4 (19.1) C1220T (Braze Connection)	φ7/8 (22.2) C1220T (Braze Connection)
Weight	727 (330)	793 (360)	793 (360)
Sound Pressure Level (Reference Data)	60 (65 ★3)	61 (67 ★3)	63.5 (67 ★3)
Sound Power Level (Reference Data)	79	80.5	84.5
Safety Devices	High Pressure Switch	High Pressure Switch	High Pressure Switch
	Fan Driver Overload Protector	Fan Driver Overload Protector	Fan Driver Overload Protector
	Overcurrent Fuse	Overcurrent Fuse	Overcurrent Fuse
	Inverter Overload Protector, Leak Detecting Device	Inverter Overload Protector, Leak Detecting Device	Inverter Overload Protector, Leak Detecting Device
Defrost Method	Deicer	Deicer	Deicer
Capacity Control	11 - 100	13 - 100	12 - 100
Refrigerant Name	R410A	R410A	R410A
Charge	25.8 (11.7)	25.8 (11.7)	25.8 (11.7)
Control	Electronic Expansion Valve	Electronic Expansion Valve	Electronic Expansion Valve
Standard Accessories	Installation Manual	Installation Manual	Installation Manual
	Operation Manual	Operation Manual	Operation Manual
	Connection Pipes, Clamps	Connection Pipes, Clamps	Connection Pipes, Clamps

Notes
 ★1 Indoor temp.: 80°FDB (26.7°CDB) / Outdoor temp.: 95°FDB (35.0°CDB) / Rated capacity is certified under AHRI standard 1200.
 ★2 Indoor temp.: 70°FDB (21.1°CDB) / Outdoor temp.: 47°FDB (8.3°CDB) / Rated capacity is certified under AHRI standard 1200.
 ★3 Sound pressure level may increase during heating operation at ambient temps below 41°F (5°C) value in parenthesis is the max sound pressure at those conditions.

RXLQ144 / 192 / 240TBVCA

Outdoor Unit Model No.	RXLQ144TBVCA	RXLQ192TBVCA	RXLQ240TBVCA	
Unit Combination	RXLQ72TBVCA RXLQ96TBVCA	RXLQ96TBVCA RXLQ96TBVCA	RXLQ120TBVCA RXLQ120TBVCA	
Power Supply	3 phase, 60Hz, 575V	3 phase, 60Hz, 575V	3 phase, 60Hz, 575V	
★1 Cooling Capacity	Btu/h (kW)	Nominal 144,000 (42.2) Rated 138,000 (40.4)	Nominal 192,000 (56.3) Rated 184,000 (53.9)	Nominal 238,000 (69.8) Rated 228,000 (66.8)
	Btu/h (kW)	Nominal 162,000 (47.5) Rated 138,000 (40.4)	Nominal 216,000 (63.3) Rated 184,000 (53.9)	Nominal 270,000 (79.1) Rated 228,000 (66.8)
★2 Heating Capacity	Btu/h (kW)	Nominal 138,000 (40.4) Rated 162,000 (47.5)	Nominal 184,000 (53.9) Rated 216,000 (63.3)	Nominal 228,000 (66.8) Rated 270,000 (79.1)
Casing Color	Mony White (57.5/1)	Mony White (57.5/1)	Mony White (57.5/1)	
Dimensions: (H x W x D)	66-11/16 x 48-7/8 x 30-3/16 + 66-11/16 x 48-7/8 x 30-3/16 (1694 x 1242 x 767 + 1694 x 1242 x 767)	66-11/16 x 48-7/8 x 30-3/16 + 66-11/16 x 48-7/8 x 30-3/16 (1694 x 1242 x 767 + 1694 x 1242 x 767)	66-11/16 x 48-7/8 x 30-3/16 + 66-11/16 x 48-7/8 x 30-3/16 (1694 x 1242 x 767 + 1694 x 1242 x 767)	
Heat Exchanger	Cross Fin Coil	Cross Fin Coil	Cross Fin Coil	
Type	Hermetically Sealed Scroll Type	Hermetically Sealed Scroll Type	Hermetically Sealed Scroll Type	
Displacement	m ³ /h	17.0 + 17.0	21.2 + 21.2	
Number of Revolutions	r/min	3204 + 3204	4002 + 4002	
Motor Output x Number of units	kW	4.1 x 1 + 4.1 x 1	6.1 x 1 + 6.1 x 1	
Starting Method	Soft Start	Soft Start	Soft Start	
Type	Propeller Fan	Propeller Fan	Propeller Fan	
Motor Output	kW	(0.7 x 2) x 2	(0.7 x 2) x 2	
Airflow Rate	cfm (m ³ /min)	7283 + 7283 (206 + 206)	7989 + 7989 (226 + 226)	
Drive	Direct Drive	Direct Drive	Direct Drive	
Liquid Pipe	in. (mm)	φ5/8 (12.7) C1220T (Braze Connection)	φ5/8 (15.9) C1220T (Braze Connection)	
Gas Pipe	in. (mm)	φ1-7/8 (28.6) C1220T (Braze Connection)	φ1-7/8 (28.6) C1220T (Braze Connection)	
Weight	lbs (kg)	727 + 727 (330 + 330)	793 + 793 (360 + 360)	
Sound pressure level (Reference data)	dB(A)	63 (68 ★3)	64 (70 ★3)	
Sound power level (Reference data)	dB	82	83.5	
Safety Devices	High Pressure Switch, Fan Driver Overload Protector, Overcurrent Fuse, Inverter Overload Protector, Leak Detecting Device	High Pressure Switch, Fan Driver Overload Protector, Overcurrent Fuse, Inverter Overload Protector, Leak Detecting Device	High Pressure Switch, Fan Driver Overload Protector, Overcurrent Fuse, Inverter Overload Protector, Leak Detecting Device	
Defrost Method	Deicer	Deicer	Deicer	
Capacity Control	%	5 - 100	6 - 100	
Refrigerant Name	R410A	R410A	R410A	
Charge Control	lbs (kg)	25.8 + 25.8 (11.7 + 11.7)	25.8 + 25.8 (11.7 + 11.7)	
Standard Accessories	Installation Manual, Operation Manual, Connection Pipes, Clamps	Installation Manual, Operation Manual, Connection Pipes, Clamps	Installation Manual, Operation Manual, Connection Pipes, Clamps	

Notes
 ★1 Indoor temp.: 80°FDB (26.7°CDB) / 67°FIB (19.4°CIB) / Outdoor temp.: 95°FDB (35.0°CDB) / Rated capacity is certified under AHRI standard 1200.
 ★2 Indoor temp.: 70°FDB (21.1°CDB) / 47°FIB (8.3°CIB) / Outdoor temp.: 43°FDB (6.1°CDB) / Rated capacity is certified under AHRI standard 1200.
 ★3 Sound pressure level may increase during heating operation at ambient temps below 41°F (5°C) value in parenthesis is the max sound pressure at those conditions.

RXLQ144 / 192 / 240TBTJA / TBYDA / TBYCA

Unit : in. (mm)

Example of space required for installation.

Model Name	Outdoor Unit 1	Drawing No.	Outdoor Unit 2	Drawing No.
RXYQ192XBXYCA	RXYQ96XBXYCA	3D149936	RXYQ96XBXYCA	3D149936
RXYQ216XBXYCA	RXYQ120XBXYCA	3D149936	RXYQ96XBXYCA	3D149936
RXYQ240XBXYCA	RXYQ120XBXYCA	3D149936	RXYQ120XBXYCA	3D149936
RXYQ264XBXYCA	RXYQ144XBXYCA	3D149936	RXYQ120XBXYCA	3D149936
RXYQ288XBXYCA	RXYQ144XBXYCA	3D149936	RXYQ144XBXYCA	3D149936
RXYQ312XBXYCA	RXYQ168XBXYCA	3D149936	RXYQ144XBXYCA	3D149936
RXYQ336XBXYCA	RXYQ168XBXYCA	3D149936	RXYQ168XBXYCA	3D149936
RXLQ144TBYCA	RXLQ72TBYCA	3D149936	RXLQ72TBYCA	3D149936
RXLQ192TBYCA	RXLQ96TBYCA	3D149936	RXLQ96TBYCA	3D149936
RXLQ240TBYCA	RXLQ120TBYCA	3D149936	RXLQ120TBYCA	3D149936
RXLQ144TBTJA	RXLQ72TBTJA	3D149936	RXLQ72TBTJA	3D149936
RXLQ192TBTJA	RXLQ96TBTJA	3D149936	RXLQ96TBTJA	3D149936
RXLQ240TBTJA	RXLQ120TBTJA	3D149936	RXLQ120TBTJA	3D149936
RXLQ144TBYDA	RXLQ72TBYDA	3D149936	RXLQ72TBYDA	3D149936
RXLQ192TBYDA	RXLQ96TBYDA	3D149936	RXLQ96TBYDA	3D149936
RXLQ240TBYDA	RXLQ120TBYDA	3D149936	RXLQ120TBYDA	3D149936

Notes :

1. Heights of walls of this example:
 Front : 59 in. (1500mm)
 Suction side : 19-5/8 in. (500mm)
 Side : Height unrestricted
2. The installation space shown in this figure is based on the condition of cooling operation at the outdoor air temperature of 95°FDB(35°CDB).
 * Design outdoor temperature becomes over 95°FDB(35°CDB).
 * Operating over max. operating load (in case of causing a heavy heating load at indoor unit side service spaces respectively as shown in the following figure).
3. When installing the units, the most appropriate pattern should be selected from "Installation and repair space drawing" in order to obtain the best fit in the space available always bearing in mind the need to leave enough room for a person to pass between units and wall and for the air to circulate freely.
 (If more units are to be installed than are shown in "Installation and repair space drawing", your layout should take account of the possibility of short circuiting.)
4. The units should be installed to leave sufficient space at the front for the on site refrigerant piping work to be carried out comfortably.

3. Service Space

3.1 RXLQ-TBTJA / TBYDA / TBYCA RXLQ72 - 240TBTJA / TBYDA / TBYCA

Unit : in. (mm)

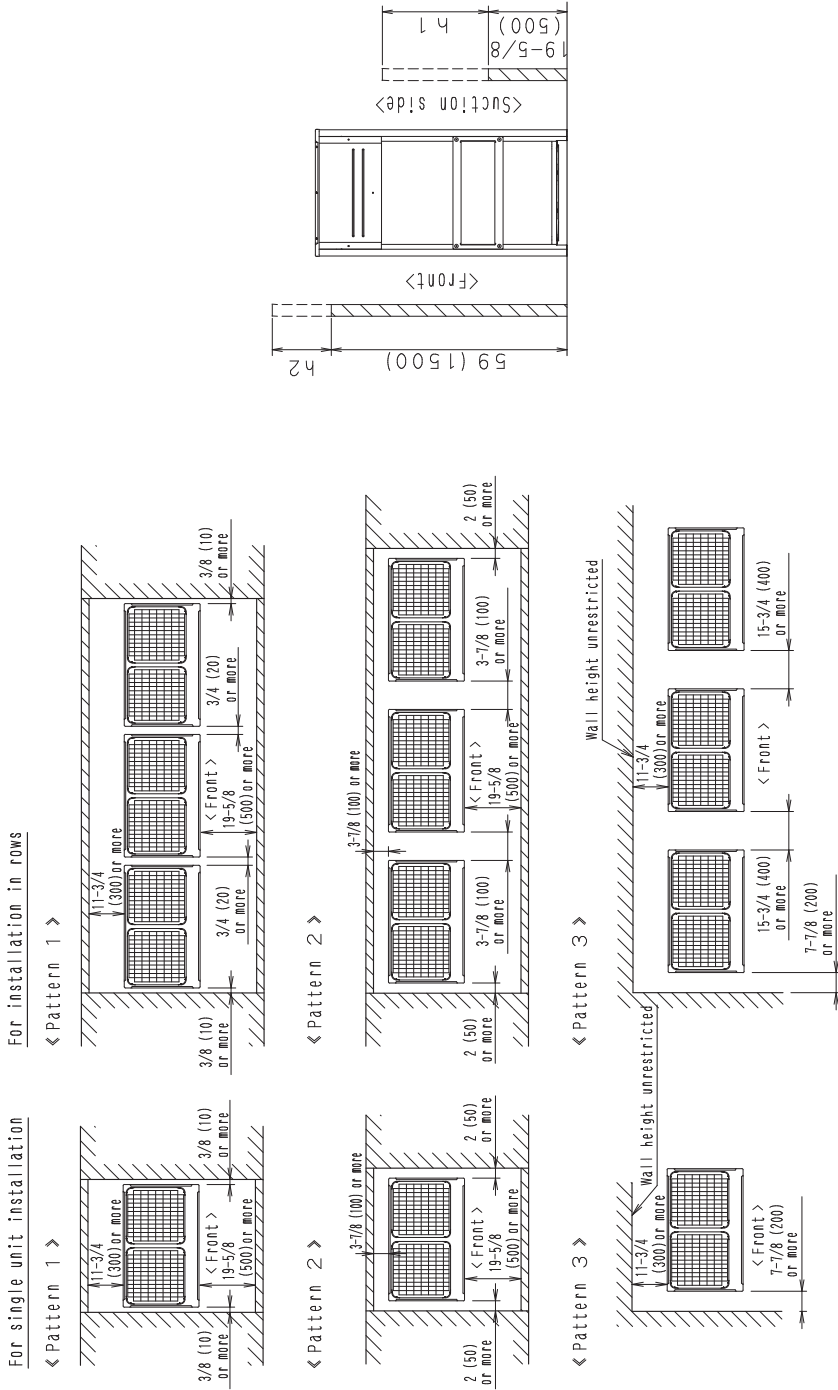

Notes:

1. Heights of walls in case of Patterns 1 and 2;
Front : 59 in. (1500 mm)
Suction side : 19-5/8 in. (500 mm)
Side : Height unrestricted
- The installation space shown in this figure is based on the condition of cooling operation at the outdoor air temperature of 95°FDB (35°CDB).
The installation space of suction side shown above must be expanded in the following case.
 - Design outdoor temperature becomes over 95°FDB (35°CDB).
 - Operating over max. operating load (in case of causing a heavy heating load at indoor unit side)
2. If the above wall heights are exceeded then h2/2 and h1/2 should be added to the front and suction side service spaces respectively as shown in the following figure.
3. When installing the units the most appropriate pattern should be selected from "Installation and repair space drawing" in order to obtain the best fit in the space available always bearing in mind the need to leave enough room for a person to pass between units and wall and for the air to circulate freely. (If more units are to be installed than are shown in "Installation and repair space drawing", your layout should take account of the possibility of short circuiting.)
4. The units should be installed to leave sufficient space at the front for the on site refrigerant piping work to be carried out comfortably.

C: 3D085503H

4. Center of Gravity

RXLQ72TBTJA / TBYDA / TBYCA

Unit : in. (mm)

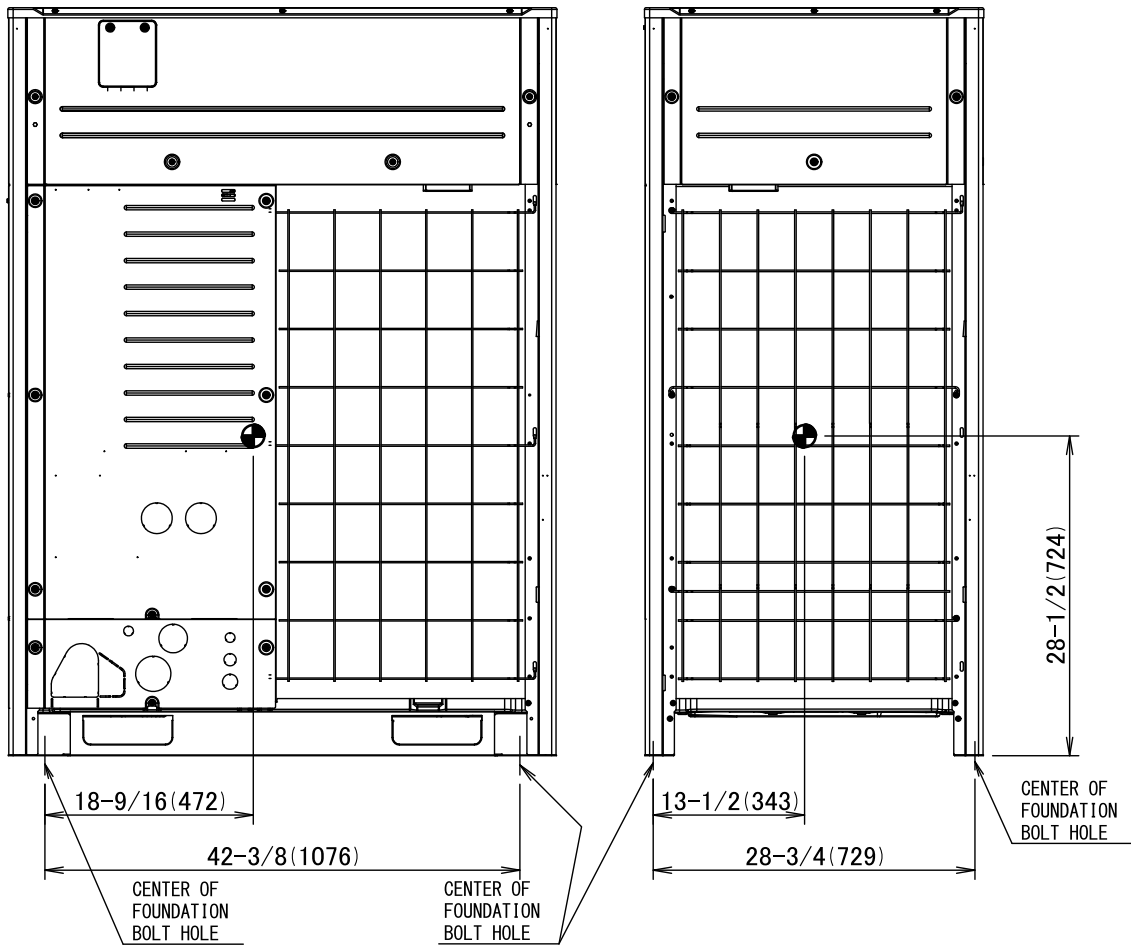

3. Specification

RXLQ96 / 120TBTJA / TBYDA / TBYCA

Unit : in. (mm)

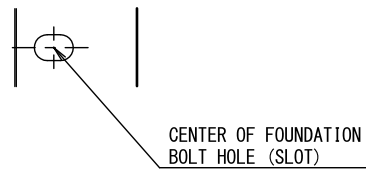
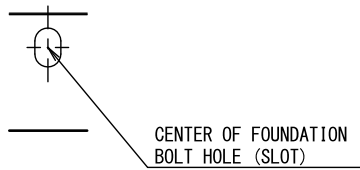
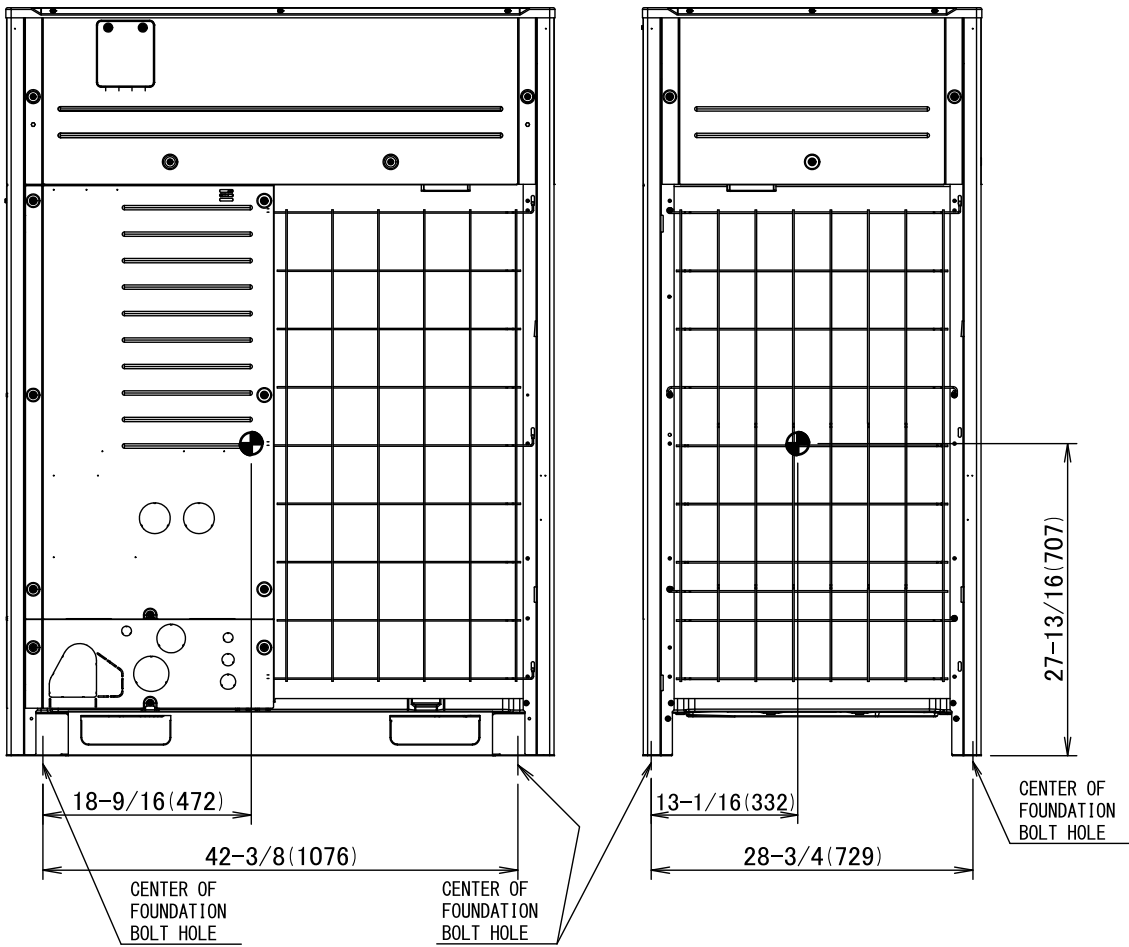

6. Piping Diagrams

RXLQ72TBTJA / TBYDA / TBYCA

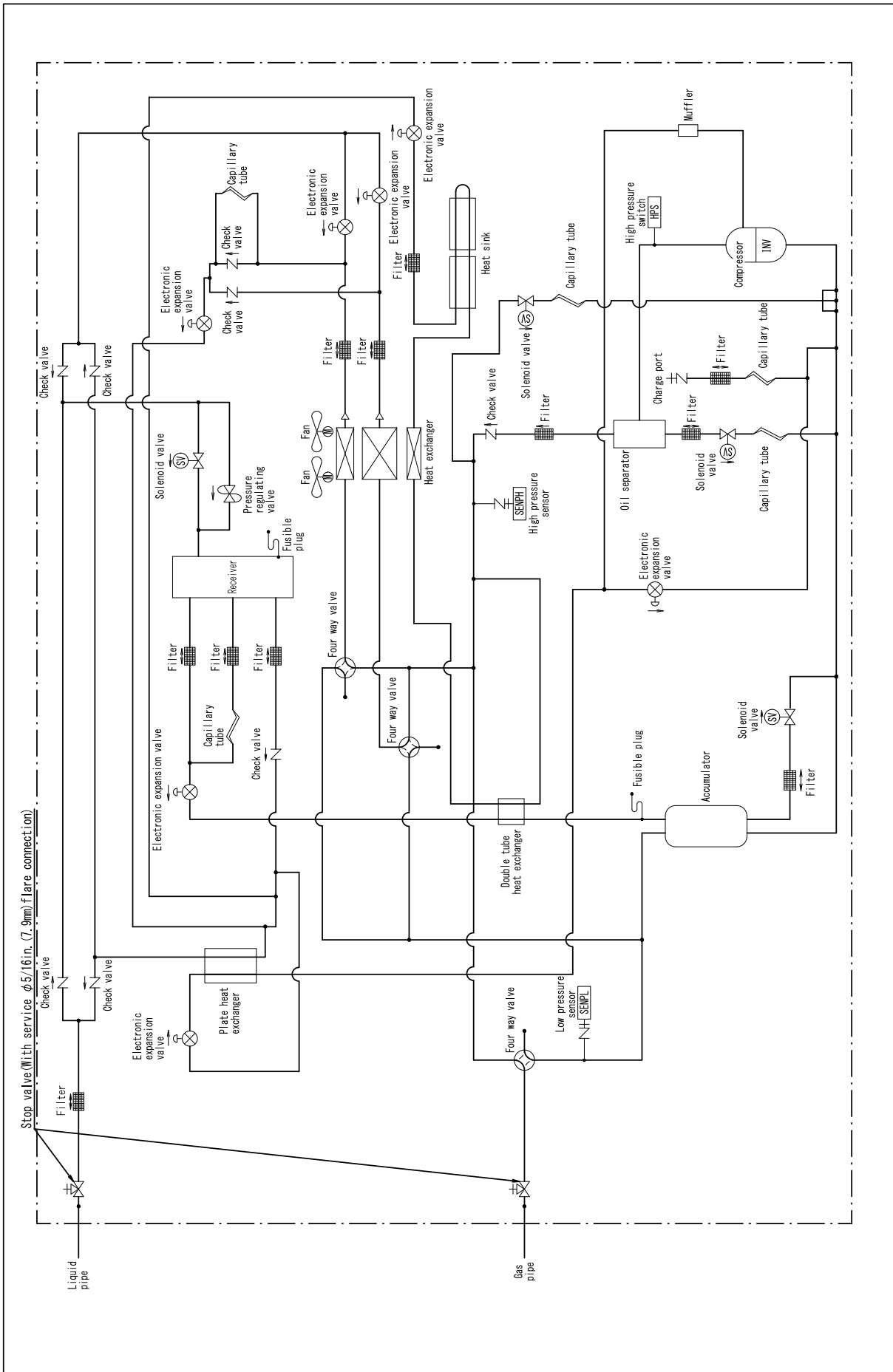

RXLQ96 / 120TBTJA / TBYDA / TBYCA

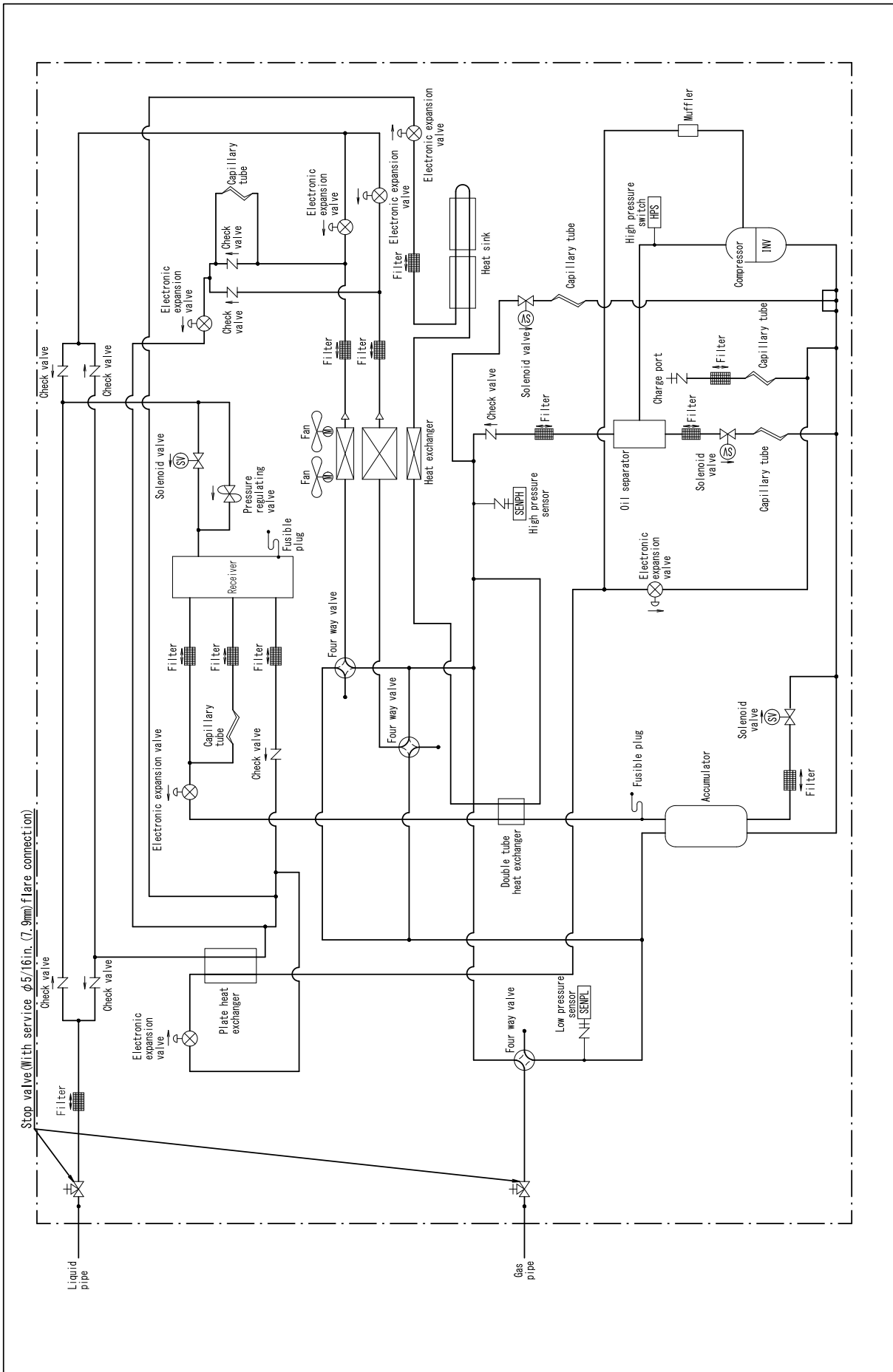

7. Wiring Diagrams

RXLQ72TBTJA

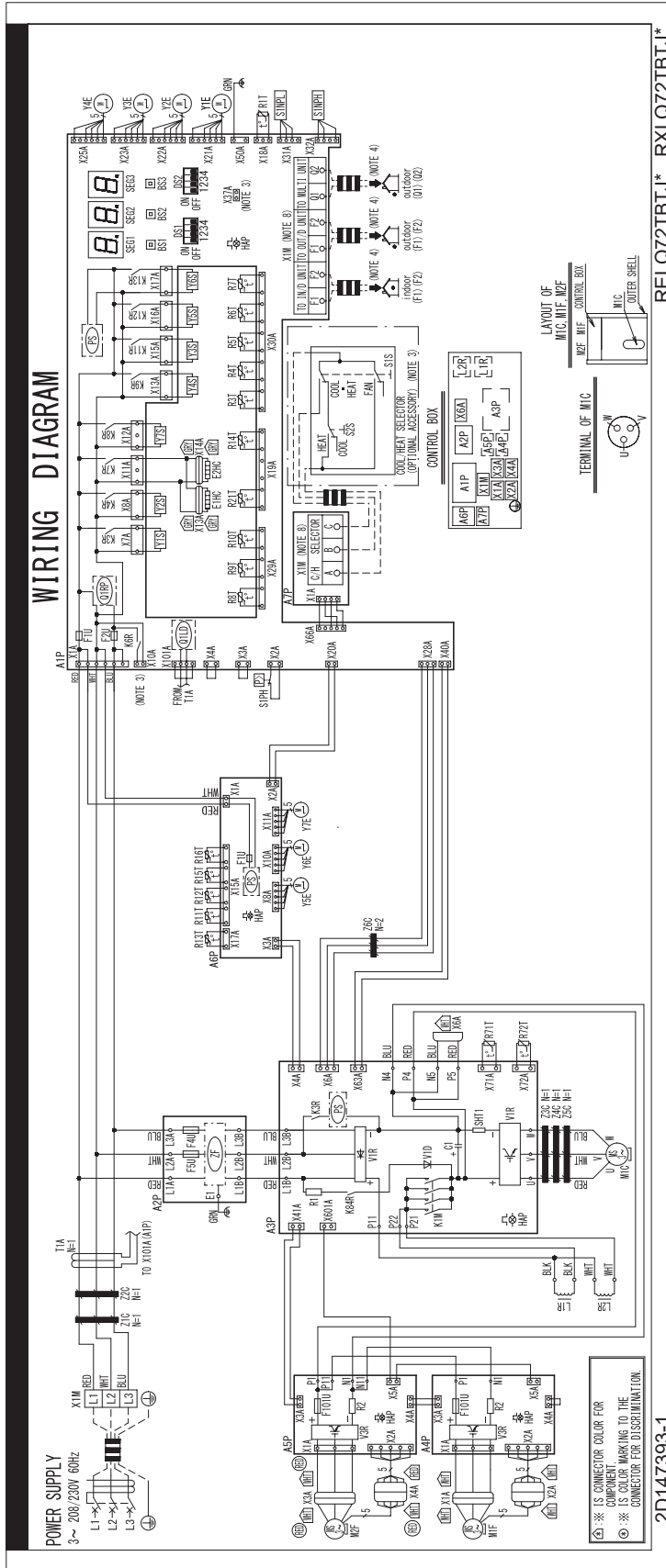

NOTES)

1. THIS WIRING DIAGRAM APPLIES ONLY TO THE OUTDOOR UNIT.
2. : FIELD WIRING, : TERMINAL BLOCK, : CONNECTOR, : TERMINAL, : PROTECTIVE GROUND (SCREW), : NOISELESS GROUND.
3. WHEN USING THE OPTIONAL ADAPTOR, REFER TO THE INSTALLATION MANUAL OF THE OPTIONAL ADAPTOR.
4. FOR CONNECTION WIRING TO INDOOR-OUTDOOR TRANSMISSION F1·F2, OUTDOOR-OUTDOOR TRANSMISSION F1·F2, OUTDOOR-MULTI TRANSMISSION Q1·Q2, REFER TO THE INSTALLATION MANUAL CONTROL BOX COVER.
5. HOW TO USE BS1~3 SWITCH, REFER TO SERVICE PRECAUTION LABEL ON CONTROL BOX COVER.
6. WHEN OPERATING, DO NOT SHORTCIRCUIT THE PROTECTION DEVICE(S1PH).
7. COLORS BLK : BLACK ; RED : RED ; BLU : BLUE ; WHT : WHITE ; GRN : GREEN ; GRY : GRAY ; YLW : YELLOW.
8. CLASS 2 WIRE

RXLQ72TBTJA

A1P	PRINTED CIRCUIT BOARD (MAIN)	R12T	THERMISTOR (COMPSUCTION)
A2P	PRINTED CIRCUIT BOARD (NOISE FILTER)	R13T	THERMISTOR (RECEIVER GAS PURGE)
A3P	PRINTED CIRCUIT BOARD (INV)	R14T	THERMISTOR (M1C BODY)
A4P, A5P	PRINTED CIRCUIT BOARD (FAN)	R15T	THERMISTOR (LEAK DETECTION)
A6P	PRINTED CIRCUIT BOARD (SUB)	R16T	THERMISTOR (EVT)
A7P	PRINTED CIRCUIT BOARD (ABC I/P)	R21T	THERMISTOR (M1C DISCHARGE)
BS1~BS3	PUSH BUTTON SWITCH (A1P) (MODE, SET, RETURN)	R71T	THERMISTOR (L1R)
C1	CAPACITOR (A3P)	R72T	THERMISTOR (L2R)
DS1, DS2	DIP SWITCH (A1P)	S1NPH	PRESSURE SENSOR (HIGH)
E1HC, E2HC	CRANKCASE HEATER	S1NPL	PRESSURE SENSOR (LOW)
F1U	FUSE (A1P, A6P)	S1PH	PRESSURE SWITCH (HIGH)
F2U	FUSE (A1P)	SEG1~SEG3	7-SEGMENT DISPLAY (A1P)
F101U	FUSE (A4P, A5P)	SHT1	CURRENT SENSOR (A3P)
F4U, F5U	FUSE (A2P)	T1A	CURRENT SENSOR
HAP	PILOTLAMP (A1P, A3P~A6P) (SERVICE MONITOR-GREEN)	V1D	DIODE (A3P)
K3R	MAGNETIC RELAY (A3P)	V1R	POWER MODULE (A3P)
K1M	MAGNETIC CONTACTOR (A4P)	V3R	POWER MODULE (A4P, A5P)
K3R	MAGNETIC RELAY (Y1S) (A1P)	X1A, X2A	CONNECTOR (M1F)
K4R	MAGNETIC RELAY (Y2S) (A1P)	X3A, X4A	CONNECTOR (M2F)
K6R	MAGNETIC RELAY (OPTION) (A1P)	X6A	CONNECTOR (CHECK THE RESIDUAL CHARGE)
K7R	MAGNETIC RELAY (E1HC, E2HC) (A1P)	X13A, X14A	CONNECTOR (E1HC, E2HC)
K8R	MAGNETIC RELAY (Y7S) (A1P)	X1M	TERMINAL BLOCK (POWER SUPPLY)
K9R	MAGNETIC RELAY (Y4S) (A1P)	X1M	TERMINAL BLOCK (CONTROL) (A1P)
K11R	MAGNETIC RELAY (Y3S) (A1P)	X1M	TERMINAL BLOCK (ABC I/P) (A7P)
K12R	MAGNETIC RELAY (Y5S) (A1P)	Y1E	ELECTRIC EXPANSION VALVE (HEAT EXC. UPPER)
K13R	MAGNETIC RELAY (Y6S) (A1P)	Y2E	ELECTRIC EXPANSION VALVE (SUBCOOL HEAT EXC.)
K84R	MAGNETIC RELAY (A3P)	Y3E	ELECTRIC EXPANSION VALVE (HEAT EXC. LOWER)
L1R, L2R	REACTOR	Y4E	ELECTRIC EXPANSION VALVE (INJECTION)
M1C	MOTOR (COMPRESSOR)	Y5E	ELECTRIC EXPANSION VALVE (REFRIGERAT COOLING)
M1F, M2F	MOTOR (FAN)	Y6E	ELECTRIC EXPANSION VALVE (LEAK DETECTION)
PS	SWITCHING POWER SUPPLY (A1P, A3P, A6P)	Y7E	ELECTRIC EXPANSION VALVE (RECEIVER GAS PURGE)
Q1LD	LEAKAGE DETECTION CIRCUIT (A1P)	Y1S	SOLENOID VALVE (OS OIL RETURN 1)
Q1RP	REVERSE PHASE PROTECTOR CIRCUIT (A1P)	Y2S	SOLENOID VALVE (HOT GAS BYPASS)
R1	RESISTOR (CURRENT LIMITING) (A3P)	Y3S	SOLENOID VALVE (LIQUID SHUT OFF)
R2	RESISTOR (CURRENT SENSOR) (A4P, A5P)	Y4S	4WAY VALVE (HP/LP GAS)
R1T	THERMISTOR (AIR)	Y5S	4WAY VALVE (HEAT EXC. LOWER)
R3T	THERMISTOR (RECEIVER INLET)	Y6S	4WAY VALVE (HEAT EXC. UPPER)
R4T	THERMISTOR (HEAT EXC. LIQUID UPPER)	Y7S	SOLENOID VALVE (ACCUMU OIL RETURN)
R5T	THERMISTOR (HEAT EXC. LIQUID LOWER)	Z1C~Z6C	NOISE FILTER (FERRITE CORE)
R6T	THERMISTOR (SUBCOOL GAS)	ZF	NOISE FILTER (A2P) (WITH SURGE ABSORBER)
R7T	THERMISTOR (SUBCOOL LIQUID)	CONNECTOR FOR OPTIONAL ACCESSORIES	
R8T	THERMISTOR (HEAT EXC. GAS UPPER)	X37A	CONNECTOR (POWER ADAPTER) (A1P)
R9T	THERMISTOR (HEAT EXC. GAS LOWER)	COOL/HEAT SELECTOR	
R10T	THERMISTOR (SUCTION)	S1S	SELECTOR SWITCH (FAN/COOL-HEAT)
R11T	THERMISTOR (DEICER)	S2S	SELECTOR SWITCH (COOL/HEAT)

C: 2D147393

RXLQ96 - 120TBTJA

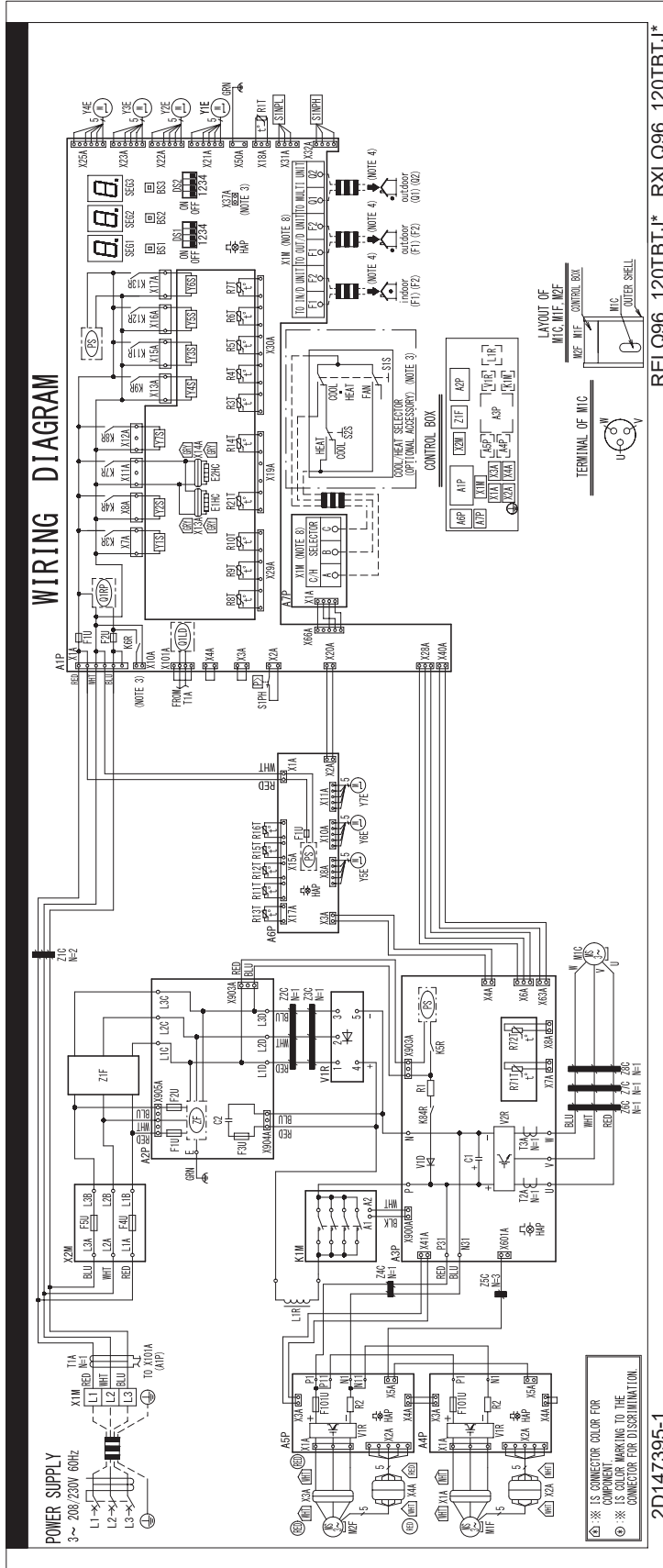

NOTES

1. THIS WIRING DIAGRAM APPLIES ONLY TO THE OUTDOOR UNIT.
2. — — — : FIELD WIRING; □ : TERMINAL BLOCK, ⊠ : CONNECTOR,
 —○— : TERMINAL, ⊕ : PROTECTIVE GROUND (SCREW), ⊕ : NOISELESS GROUND.
3. WHEN USING THE OPTIONAL ADAPTOR, REFER TO THE INSTALLATION MANUAL OF THE OPTIONAL ADAPTOR.
4. FOR CONNECTION WIRING TO INDOOR-OUTDOOR TRANSMISSION F1-F2, OUTDOOR-OUTDOOR TRANSMISSION F1-F2 OUTDOOR-MULTI TRANSMISSION Q1-Q2, REFER TO THE INSTALLATION MANUAL.
5. HOW TO USE BS1~3 SWITCH, REFER TO SERVICE PRECAUTION LABEL ON CONTROL BOX COVER.
6. WHEN OPERATING, DO NOT SHORTCIRCUIT THE PROTECTION DEVICE(S1PH).
7. COLORS BLK : BLACK ; RED : RED ; BLU : BLUE ; WHT : WHITE ; GRN : GREEN ; GRY : GRAY ; YLW : YELLOW.
8. CLASS 2 WIRE

RELQ96, 120TBTJ* RXLQ96, 120TBTJ*

2D147395-1

RXLQ96 - 120TBTJA

A1P	PRINTED CIRCUIT BOARD (MAIN)	R12T	THERMISTOR (COMPSUCTION)
A2P	PRINTED CIRCUIT BOARD (NOISE FILTER)	R13T	THERMISTOR (RECEIVER GAS PURGE)
A3P	PRINTED CIRCUIT BOARD (INV)	R14T	THERMISTOR (M1C BODY)
A4P, A5P	PRINTED CIRCUIT BOARD (FAN)	R15T	THERMISTOR (LEAK DETECTION)
A6P	PRINTED CIRCUIT BOARD (SUB)	R16T	THERMISTOR (EVT)
A7P	PRINTED CIRCUIT BOARD (ABC I/P)	R21T	THERMISTOR (M1C DISCHARGE)
BS1~BS3	PUSH BUTTON SWITCH (A1P) (MODE, SET, RETURN)	R71T	THERMISTOR (POWER MODULE) (A3P)
C1	CAPACITOR (A3P)	R72T	THERMISTOR (DIODE) (A3P)
C2	CAPACITOR (A2P)	S1NPH	PRESSURE SENSOR (HIGH)
DS1, DS2	DIP SWITCH (A1P)	S1NPL	PRESSURE SENSOR (LOW)
E1HC, E2HC	CRANKCASE HEATER	S1PH	PRESSURE SWITCH (HIGH)
F1U	FUSE (A1P, A2P, A6P)	SEG1~SEG3	7-SEGMENT DISPLAY (A1P)
F2U	FUSE (A1P, A2P)	T1A	CURRENT SENSOR
F3U	FUSE (A2P)	T2A, T3A	CURRENT SENSOR (A3P)
F4U, F5U	FUSE (X2M)	V1D	DIODE (A3P)
F101U	FUSE (A4P,A5P)	V1R	DIODE BRIDGE
HAP	PILOTLAMP (A1P, A3P~A6P) (SERVICE MONITOR-GREEN)	V2R	POWER MODULE (A3P)
K1M	MAGNETIC CONTACTOR (A4P)	V3R	POWER MODULE (A4P, A5P)
K3R	MAGNETIC RELAY (Y1S) (A1P)	X1A, X2A	CONNECTOR (M1F)
K4R	MAGNETIC RELAY (Y2S) (A1P)	X3A, X4A	CONNECTOR (M2F)
K5R	MAGNETIC RELAY (A3P)	X13A, X14A	CONNECTOR (E1HC, E2HC)
K6R	MAGNETIC RELAY (OPTION) (A1P)	X1M	TERMINAL BLOCK (POWER SUPPLY)
K7R	MAGNETIC RELAY (E1HC, E2HC) (A1P)	X1M	TERMINAL BLOCK (CONTROL) (A1P)
K8R	MAGNETIC RELAY (Y7S) (A1P)	X1M	TERMINAL BLOCK (ABC I/P) (A7P)
K9R	MAGNETIC RELAY (Y4S) (A1P)	X2	TERMINAL BLOCK (FUSE)
K11R	MAGNETIC RELAY (Y3S) (A1P)	Y1E	ELECTRIC EXPANSION VALVE (HEAT EXC. UPPER)
K12R	MAGNETIC RELAY (Y5S) (A1P)	Y2E	ELECTRIC EXPANSION VALVE (SUBCOOL HEAT EXC.)
K13R	MAGNETIC RELAY (Y6S) (A1P)	Y3E	ELECTRIC EXPANSION VALVE (HEAT EXC. LOWER)
K84R	MAGNETIC RELAY (A3P)	Y4E	ELECTRIC EXPANSION VALVE (INJECTION)
L1R	REACTOR	Y5E	ELECTRIC EXPANSION VALVE (REFRIGERAT COOLING)
M1C	MOTOR (COMPRESSOR)	Y6E	ELECTRIC EXPANSION VALVE (LEAK DETECTION)
M1F, M2F	MOTOR (FAN)	Y7E	ELECTRIC EXPANSION VALVE (RECEIVER GAS PURGE)
PS	SWITCHING POWER SUPPLY (A1P, A3P, A6P)	Y1S	SOLENOID VALVE (OS OIL RETURN 1)
Q1LD	LEAKAGE DETECTION CIRCUIT (A1P)	Y2S	SOLENOID VALVE (HOT GAS BYPASS)
Q1RP	REVERSE PHASE PROTECTOR CIRCUIT (A1P)	Y3S	SOLENOID VALVE (LIQUID SHUT OFF)
R1	RESISTOR (CURRENT LIMITING) (A3P)	Y4S	4WAY VALVE (HP/LP GAS)
R2	RESISTOR (CURRENT SENSOR) (A4P, A5P)	Y5S	4WAY VALVE (HEAT EXC. LOWER)
R1T	THERMISTOR (AIR)	Y6S	4WAY VALVE (HEAT EXC. UPPER)
R3T	THERMISTOR (RECEIVER INLET)	Y7S	SOLENOID VALVE (ACCUMU OIL RETURN)
R4T	THERMISTOR (HEAT EXC. LIQUID UPPER)	Z1C~Z8C	NOISE FILTER (FERRITE CORE)
R5T	THERMISTOR (HEAT EXC. LIQUID LOWER)	Z1F	NOISE FILTER
R6T	THERMISTOR (SUBCOOL GAS)	ZF	NOISE FILTER (A2P) (WITH SURGE ABSORBER)
R7T	THERMISTOR (SUBCOOL LIQUID)	CONNECTOR FOR OPTIONAL ACCESSORIES	
R8T	THERMISTOR (HEAT EXC. GAS UPPER)	X37A	CONNECTOR (POWER ADAPTER) (A1P)
R9T	THERMISTOR (HEAT EXC. GAS LOWER)	COOL/HEAT SELECTOR	
R10T	THERMISTOR (SUCTION)	S1S	SELECTOR SWITCH (FAN/COOL-HEAT)
R11T	THERMISTOR (DEICER)	S2S	SELECTOR SWITCH (COOL/HEAT)

C: 2D147395

RXLQ72TBYDA

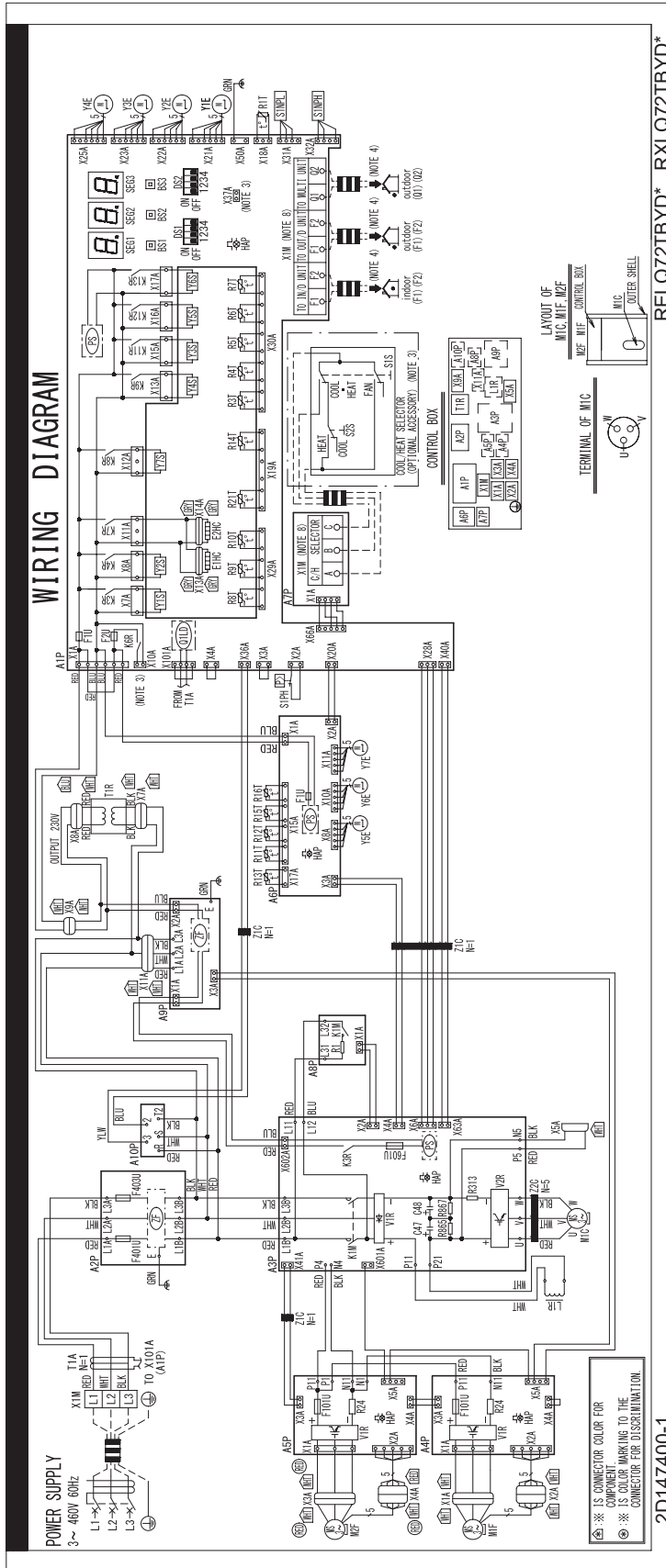

NOTES

1. THIS WIRING DIAGRAM APPLIES ONLY TO THE OUTDOOR UNIT.
2. : FIELD WIRING, : TERMINAL BLOCK, : CONNECTOR, : TERMINAL, : PROTECTIVE GROUND (SCREW), : NOISELESS GROUND.
3. WHEN USING THE OPTIONAL ADAPTOR, REFER TO THE INSTALLATION MANUAL OF THE OPTIONAL ADAPTOR.
4. FOR CONNECTION WIRING TO INDOOR-OUTDOOR TRANSMISSION F1·F2, OUTDOOR-OUTDOOR TRANSMISSION F1·F2 OUTDOOR-MULTI TRANSMISSION Q1·Q2, REFER TO THE INSTALLATION MANUAL.
5. HOW TO USE BS1~3 SWITCH, REFER TO SERVICE PRECAUTION LABEL ON CONTROL BOX COVER.
6. WHEN OPERATING, DO NOT SHORTCIRCUIT THE PROTECTION DEVICE(S1PH).
7. COLORS BLK : BLACK ; RED : RED ; BLU : BLUE ; WHT : WHITE ; GRN : GREEN ; GRY : GRAY ; YLW : YELLOW.
8. CLASS 2 WIRE

RXLQ72TBYDA

A1P	PRINTED CIRCUIT BOARD (MAIN)	R10T	THERMISTOR (SUCTION)
A2P	PRINTED CIRCUIT BOARD (NOISE FILTER)	R11T	THERMISTOR (DEICER)
A3P	PRINTED CIRCUIT BOARD (INV)	R12T	THERMISTOR (COMPSUCTION)
A4P, A5P	PRINTED CIRCUIT BOARD (FAN)	R13T	THERMISTOR (RECEIVER GAS PURGE)
A6P	PRINTED CIRCUIT BOARD (SUB)	R14T	THERMISTOR (M1C BODY)
A7P	PRINTED CIRCUIT BOARD (ABC I/P)	R15T	THERMISTOR (LEAK DETECTION)
A8P	PRINTED CIRCUIT BOARD (CURRENT LIMITING)	R16T	THERMISTOR (EVT)
A9P	PRINTED CIRCUIT BOARD (NOISE FILTER)	R21T	THERMISTOR (M1C DISCHARGE)
A10P	PRINTED CIRCUIT BOARD (OPEN PHASE PROTECTION)	S1NPH	PRESSURE SENSOR (HIGH)
BS1~BS3	PUSH BUTTON SWITCH (A1P) (MODE, SET, RETURN)	S1NPL	PRESSURE SENSOR (LOW)
C47, C48	CAPACITOR (A3P)	S1PH	PRESSURE SWITCH (HIGH)
DS1, DS2	DIP SWITCH (A1P)	SEG1~SEG3	7-SEGMENT DISPLAY (A1P)
E1HC, E2HC	CRANKCASE HEATER	T1A	CURRENT SENSOR
F1U	FUSE (A1P, A6P)	T1R	TRANSFORMER (460 V/230 V)
F2U	FUSE (A1P)	V1R	DIODE BRIDGE (A3P)
F101U	FUSE (A4P, A5P)	V1R	POWER MODULE (A4P, A5P)
F401U, F403U	FUSE (A2P)	V2R	POWER MODULE (A3P)
F601U	FUSE (A3P)	X1A, X2A	CONNECTOR (M1F)
HAP	PILOTLAMP (A1P, A3P~A6P) (SERVICE MONITOR-GREEN)	X3A, X4A	CONNECTOR (M2F)
K1M	MAGNETIC CONTACTOR (A3P)	X5A	CONNECTOR (CHECK THE RESIDUAL CHARGE)
K1M	MAGNETIC CONTACTOR (A8P)	X7A, X8A	CONNECTOR (T1R)
K3R	MAGNETIC RELAY (A3P)	X9A, X11A	CONNECTOR
K3R	MAGNETIC RELAY (Y1S) (A1P)	X13A, X14A	CONNECTOR (E1HC, E2HC)
K4R	MAGNETIC RELAY (Y2S) (A1P)	X1M	TERMINAL BLOCK (POWER SUPPLY)
K6R	MAGNETIC RELAY (OPTION) (A1P)	X1M	TERMINAL BLOCK (CONTROL) (A1P)
K7R	MAGNETIC RELAY (E1HC, E2HC) (A1P)	X1M	TERMINAL BLOCK (ABC I/P) (A7P)
K8R	MAGNETIC RELAY (Y7S) (A1P)	Y1E	ELECTRIC EXPANSION VALVE (HEAT EXC. UPPER)
K9R	MAGNETIC RELAY (Y4S) (A1P)	Y2E	ELECTRIC EXPANSION VALVE (SUBCOOL HEAT EXC.)
K11R	MAGNETIC RELAY (Y3S) (A1P)	Y3E	ELECTRIC EXPANSION VALVE (HEAT EXC. LOWER)
K12R	MAGNETIC RELAY (Y5S) (A1P)	Y4E	ELECTRIC EXPANSION VALVE (INJECTION)
K13R	MAGNETIC RELAY (Y6S) (A1P)	Y5E	ELECTRIC EXPANSION VALVE (REFRIGERAT COOLING)
L1R	REACTOR	Y6E	ELECTRIC EXPANSION VALVE (LEAK DETECTION)
M1C	MOTOR (COMPRESSOR)	Y7E	ELECTRIC EXPANSION VALVE (RECEIVER GAS PURGE)
M1F, M2F	MOTOR (FAN)	Y1S	SOLENOID VALVE (OS OIL RETURN 1)
PS	SWITCHING POWER SUPPLY (A1P, A3P, A6P)	Y2S	SOLENOID VALVE (HOT GAS BYPASS)
Q1LD	LEAKAGE DETECTION CIRCUIT (A1P)	Y3S	SOLENOID VALVE (LIQUID SHUT OFF)
R1	RESISTOR (CURRENT LIMITING) (A8P)	Y4S	4WAY VALVE (HP/LP GAS)
R24	RESISTOR (CURRENT SENSOR) (A4P, A5P)	Y5S	4WAY VALVE (HEAT EXC. LOWER)
R313	RESISTOR (CURRENT SENSOR) (A3P)	Y6S	4WAY VALVE (HEAT EXC. UPPER)
R865, R867	RESISTOR (A3P)	Y7S	SOLENOID VALVE (ACCUMU OIL RETURN)
R1T	THERMISTOR (AIR)	Z1C, Z2C	NOISE FILTER (FERRITE CORE)
R3T	THERMISTOR (RECEIVER INLET)	ZF	NOISE FILTER (A2P, A9P) (WITH SURGE ABSORBER)
R4T	THERMISTOR (HEAT EXC. LIQUID UPPER)	CONNECTOR FOR OPTIONAL ACCESSORIES	
R5T	THERMISTOR (HEAT EXC. LIQUID LOWER)	X37A	CONNECTOR (POWER ADAPTER) (A1P)
R6T	THERMISTOR (SUBCOOL GAS)	COOL/HEAT SELECTOR	
R7T	THERMISTOR (SUBCOOL LIQUID)	S1S	SELECTOR SWITCH (FAN/COOL-HEAT)
R8T	THERMISTOR (HEAT EXC. GAS UPPER)	S2S	SELECTOR SWITCH (COOL/HEAT)
R9T	THERMISTOR (HEAT EXC. GAS LOWER)		

C: 2D147400

RXLQ96 - 120TBYDA

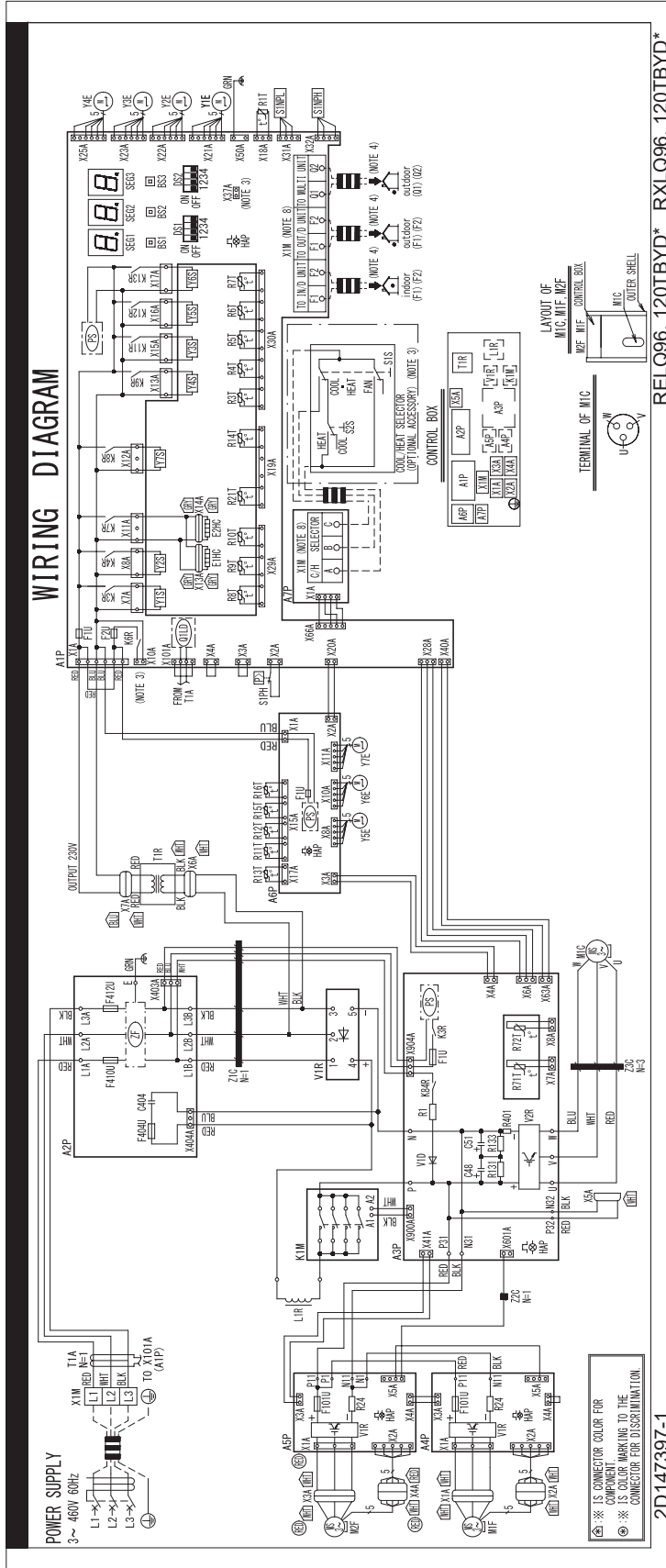

NOTES)

1. THIS WIRING DIAGRAM APPLIES ONLY TO THE OUTDOOR UNIT.
2. : FIELD WIRING; : TERMINAL BLOCK, : CONNECTOR, : TERMINAL, : PROTECTIVE GROUND (SCREW), : NOISELESS GROUND.
3. WHEN USING THE OPTIONAL ADAPTOR, REFER TO THE INSTALLATION MANUAL OF THE OPTIONAL ADAPTOR.
4. FOR CONNECTION WIRING TO INDOOR-OUTDOOR TRANSMISSION F1·F2, OUTDOOR-OUTDOOR TRANSMISSION F1·F2 OUTDOOR-MULTI TRANSMISSION Q1·Q2, REFER TO THE INSTALLATION MANUAL.
5. HOW TO USE BS1~3 SWITCH, REFER TO SERVICE PRECAUTION LABEL ON CONTROL BOX COVER.
6. WHEN OPERATING, DO NOT SHORTCIRCUIT THE PROTECTION DEVICE(S1PH).
7. COLORS BLK : BLACK ; RED : RED ; BLU : BLUE ; WHT : WHITE ; GRN : GREEN ; GRY : GRAY ; YLW : YELLOW.
8. CLASS 2 WIRE

C: 2D147397

RXLQ96 - 120TBYDA

A1P	PRINTED CIRCUIT BOARD (MAIN)	R12T	THERMISTOR (COMPSUCTION)
A2P	PRINTED CIRCUIT BOARD (NOISE FILTER)	R13T	THERMISTOR (RECEIVER GAS PURGE)
A3P	PRINTED CIRCUIT BOARD (INV)	R14T	THERMISTOR (M1C BODY)
A4P, A5P	PRINTED CIRCUIT BOARD (FAN)	R15T	THERMISTOR (LEAK DETECTION)
A6P	PRINTED CIRCUIT BOARD (SUB)	R16T	THERMISTOR (EVT)
A7P	PRINTED CIRCUIT BOARD (ABC I/P)	R21T	THERMISTOR (M1C DISCHARGE)
BS1~BS3	PUSH BUTTON SWITCH (A1P) (MODE, SET, RETURN)	R71T	THERMISTOR (POWER MODULE) (A3P)
C48, C51	CAPACITOR (A3P)	R72T	THERMISTOR (DIODE) (A3P)
C404	CAPACITOR (A2P)	S1NPH	PRESSURE SENSOR (HIGH)
DS1, DS2	DIP SWITCH (A1P)	S1NPL	PRESSURE SENSOR (LOW)
E1HC, E2HC	CRANKCASE HEATER	S1PH	PRESSURE SWITCH (HIGH)
F1U	FUSE (A1P, A3P, A6P)	SEG1~SEG3	7-SEGMENT DISPLAY (A1P)
F2U	FUSE (A1P)	T1A	CURRENT SENSOR
F101U	FUSE (A4P, A5P)	T1R	TRANSFORMER (460 V/230 V)
F404U	FUSE (A2P)	V1D	DIODE (CURRENT LIMITING) (A3P)
F410U, F412U	FUSE (A2P)	V1R	DIODE BRIDGE
HAP	PILOTLAMP (A1P, A3P~A6P) (SERVICE MONITOR-GREEN)	V1R	POWER MODULE (A4P, A5P)
K1M	MAGNETIC CONTACTOR	V2R	POWER MODULE (A3P)
K3R	MAGNETIC RELAY (A3P)	X1A, X2A	CONNECTOR (M1F)
K3R	MAGNETIC RELAY (Y1S) (A1P)	X3A, X4A	CONNECTOR (M2F)
K4R	MAGNETIC RELAY (Y2S) (A1P)	X5A	CONNECTOR (CHECK THE RESIDUAL CHARGE)
K6R	MAGNETIC RELAY (OPTION) (A1P)	X6A, X7A	CONNECTOR (T1R)
K7R	MAGNETIC RELAY (E1HC, E2HC) (A1P)	X13A, X14A	CONNECTOR (E1HC, E2HC)
K8R	MAGNETIC RELAY (Y7S) (A1P)	X1M	TERMINAL BLOCK (POWER SUPPLY)
K9R	MAGNETIC RELAY (Y4S) (A1P)	X1M	TERMINAL BLOCK (CONTROL) (A1P)
K11R	MAGNETIC RELAY (Y3S) (A1P)	X1M	TERMINAL BLOCK (ABC I/P) (A7P)
K12R	MAGNETIC RELAY (Y5S) (A1P)	Y1E	ELECTRIC EXPANSION VALVE (HEAT EXC. UPPER)
K13R	MAGNETIC RELAY (Y6S) (A1P)	Y2E	ELECTRIC EXPANSION VALVE (SUBCOOL HEAT EXC.)
K84R	MAGNETIC RELAY (A3P)	Y3E	ELECTRIC EXPANSION VALVE (HEAT EXC. LOWER)
L1R	REACTOR	Y4E	ELECTRIC EXPANSION VALVE (INJECTION)
M1C	MOTOR (COMPRESSOR)	Y5E	ELECTRIC EXPANSION VALVE (REFRIGERAT COOLING)
M1F, M2F	MOTOR (FAN)	Y6E	ELECTRIC EXPANSION VALVE (LEAK DETECTION)
PS	SWITCHING POWER SUPPLY (A1P, A3P, A6P)	Y7E	ELECTRIC EXPANSION VALVE (RECEIVER GAS PURGE)
Q1LD	LEAKAGE DETECTION CIRCUIT (A1P)	Y1S	SOLENOID VALVE (OS OIL RETURN 1)
R1	RESISTOR (CURRENT LIMITING) (A3P)	Y2S	SOLENOID VALVE (HOT GAS BYPASS)
R24	RESISTOR (CURRENT SENSOR) (A4P, A5P)	Y3S	SOLENOID VALVE (LIQUID SHUT OFF)
R131, R133	RESISTOR (A3P)	Y4S	4WAY VALVE (HP/LP GAS)
R401	RESISTOR (CURRENT SENSOR) (A3P)	Y5S	4WAY VALVE (HEAT EXC. LOWER)
R1T	THERMISTOR (AIR)	Y6S	4WAY VALVE (HEAT EXC. UPPER)
R3T	THERMISTOR (RECEIVER INLET)	Y7S	SOLENOID VALVE (ACCUMU OIL RETURN)
R4T	THERMISTOR (HEAT EXC. LIQUID UPPER)	Z1C~Z3C	NOISE FILTER (FERRITE CORE)
R5T	THERMISTOR (HEAT EXC. LIQUID LOWER)	ZF	NOISE FILTER (A2P) (WITH SURGE ABSORBER)
R6T	THERMISTOR (SUBCOOL GAS)	CONNECTOR FOR OPTIONAL ACCESSORIES	
R7T	THERMISTOR (SUBCOOL LIQUID)	X37A	CONNECTOR (POWER ADAPTER) (A1P)
R8T	THERMISTOR (HEAT EXC. GAS UPPER)	COOL/HEAT SELECTOR	
R9T	THERMISTOR (HEAT EXC. GAS LOWER)	S1S	SELECTOR SWITCH (FAN/COOL·HEAT)
R10T	THERMISTOR (SUCTION)	S2S	SELECTOR SWITCH (COOL/HEAT)
R11T	THERMISTOR (DEICER)		

C: 2D147397

RXLQ72 - 120TBYCA

A1P	PRINTED CIRCUIT BOARD (MAIN)	R13T	THERMISTOR (RECEIVER GAS PURGE)
A2P, A3P	PRINTED CIRCUIT BOARD (NOISE FILTER)	R14T	THERMISTOR (M1C BODY)
A4P	PRINTED CIRCUIT BOARD (INV)	R15T	THERMISTOR (LEAK DETECTION)
A5P, A6P	PRINTED CIRCUIT BOARD (FAN)	R16T	THERMISTOR (EVT)
A7P	PRINTED CIRCUIT BOARD (SUB)	R21T	THERMISTOR (M1C DISCHARGE)
A8P	PRINTED CIRCUIT BOARD (ABC I/P)	S1NPH	PRESSURE SENSOR (HIGH)
BS1~BS3	PUSH BUTTON SWITCH (A1P) (MODE, SET, RETURN)	S1NPL	PRESSURE SENSOR (LOW)
C1	CAPACITOR (A4P)	S1PH	PRESSURE SWITCH (HIGH)
DS1, DS2	DIP SWITCH (A1P)	SEG1~SEG3	7-SEGMENT DISPLAY (A1P)
E1HC, E2HC	CRANKCASE HEATER	T1A	CURRENT SENSOR
F1U	FUSE (A1P, A4P, A7P)	T1R	TRANSFORMER (575 V/220 V)
F2U	FUSE (A1P)	V1D	DIODE (A4P)
F101U	FUSE (A2P, A5P, A6P)	V1R	POWER MODULE (A4P)
F100U, F104U, F105U	FUSE (A2P)	V1R	POWER MODULE (A5P, A6P)
F1UT	THERMAL FUSE (A4P)	V1T	TRANSISTOR (A4P)
HAP	PILOTLAMP (A1P, A4P~A7P) (SERVICE MONITOR-GREEN)	X1A, X2A	CONNECTOR (M1F, M2F)
K1M	MAGNETIC CONTACTOR (A4P)	X5A	CONNECTOR (CHECK THE RESIDUAL CHARGE)
K3R	MAGNETIC RELAY (Y1S) (A1P)	X3A, X4A	CONNECTOR (T1R)
K4R	MAGNETIC RELAY (Y2S) (A1P)	X13A, X14A	CONNECTOR (E1HC, E2HC)
K6R	MAGNETIC RELAY (OPTION) (A1P)	X1M	TERMINAL BLOCK (POWER SUPPLY)
K7R	MAGNETIC RELAY (E1HC,E2HC) (A1P)	X1M	TERMINAL BLOCK (CONTROL) (A1P)
K8R	MAGNETIC RELAY (Y7S) (A1P)	X1M	TERMINAL BLOCK (ABC I/P) (A8P)
K9R	MAGNETIC RELAY (Y4S) (A1P)	Y1E	ELECTRIC EXPANSION VALVE (HEAT EXC. UPPER)
K11R	MAGNETIC RELAY (Y3S) (A1P)	Y2E	ELECTRIC EXPANSION VALVE (SUBCOOL HEAT EXC.)
K12R	MAGNETIC RELAY (Y5S) (A1P)	Y3E	ELECTRIC EXPANSION VALVE (HEAT EXC. LOWER)
K13R	MAGNETIC RELAY (Y6S) (A1P)	Y4E	ELECTRIC EXPANSION VALVE (INJECTION)
L1R	REACTOR	Y5E	ELECTRIC EXPANSION VALVE (REFRIGERAT COOLING)
M1C	MOTOR (COMPRESSOR)	Y6E	ELECTRIC EXPANSION VALVE (LEAK DETECTION)
M1F, M2F	MOTOR (FAN)	Y7E	ELECTRIC EXPANSION VALVE (RECEIVER GAS PURGE)
PS	SWITCHING POWER SUPPLY (A1P, A4P, A7P)	Y1S	SOLENOID VALVE (OS OIL RETURN 1)
Q1LD	LEAKAGE DETECTION CIRCUIT (A1P)	Y2S	SOLENOID VALVE (HOT GAS BYPASS)
R1	RESISTOR (CURRENT LIMITING) (A4P)	Y3S	SOLENOID VALVE (LIQUID SHUT OFF)
R2	RESISTOR (CURRENT SENSOR) (A4P, A5P, A6P)	Y4S	4WAY VALVE (HP/LP GAS)
R1T	THERMISTOR (AIR)	Y5S	4WAY VALVE (HEAT EXC. LOWER)
R3T	THERMISTOR (RECEIVER INLET)	Y6S	4WAY VALVE (HEAT EXC. UPPER)
R4T	THERMISTOR (HEAT EXC. LIQUID UPPER)	Y7S	SOLENOID VALVE (ACCUMU OIL RETURN)
R5T	THERMISTOR (HEAT EXC. LIQUID LOWER)	Z1C~Z3C	NOISE FILTER (FERRITE CORE)
R6T	THERMISTOR (SUBCOOL GAS)	ZF	NOISE FILTER (A2P, A3P) (WITH SURGE ABSORBER)
R7T	THERMISTOR (SUBCOOL LIQUID)		CONNECTOR FOR OPTIONAL ACCESSORIES
R8T	THERMISTOR (HEAT EXC. GAS UPPER)	X37A	CONNECTOR (POWER ADAPTER) (A1P)
R9T	THERMISTOR (HEAT EXC. GAS LOWER)		COOL/HEAT SELECTOR
R10T	THERMISTOR (SUCTION)	S1S	SELECTOR SWITCH (FAN/COOL·HEAT)
R11T	THERMISTOR (DEICER)	S2S	SELECTOR SWITCH (COOL/HEAT)
R12T	THERMISTOR (COMPSUCTION)		

C: 2D147402

8. Field Wiring

RXLQ72 - 120TBTJA / TBYDA / TBYCA

- 5) Unit shall be grounded in compliance with the applicable local and national codes.
- 6) Wiring shown are general points-of-connection guides only and are not intended for or to include all details for a specific installation.
- 7) Be sure to install the switch and the fuse/breaker to the power line of each piece of equipment.
- 8) Install the main switch that can interrupt all the power sources in an integrated manner because this system consists of the equipment utilizing the multiple power sources.
- 9) If there exists the possibility of reversed phase, lost phase, momentary blackout or the power goes on and off while the product is operating, attach a reversed phase protection circuit locally.
Running the product in reversed phase may break the compressor and other parts.

- Notes 1) All wiring, components and materials to be procured on the site must comply with the applicable local and national codes.
- 2) Use copper conductors only.
- 3) As for details, see wiring diagram.
- 4) Field wiring diagram is to be used as a guideline only.
Wiring should comply with applicable local and national codes.

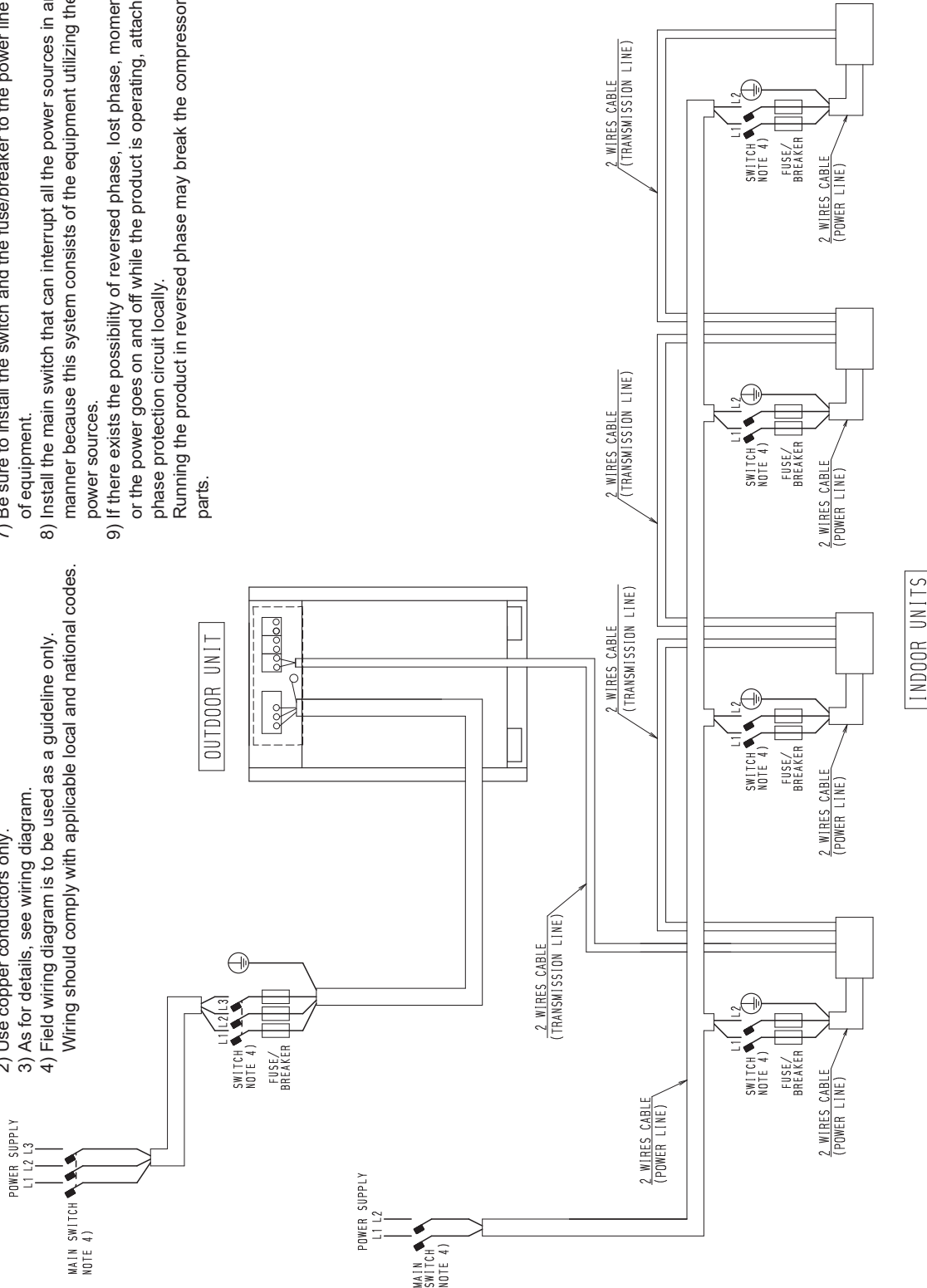

C: 3D087054C

RXLQ144 - 240TBJA / TBYDA / TBYCA

- Notes 1) All wiring, components and materials to be procured on the site must comply with the applicable local and national codes.
 2) Use copper conductors only.
 3) As for details, see wiring diagram.
 4) Field wiring diagram is to be used as a guideline only.
 Wiring should comply with applicable local and national codes.
- 5) Unit shall be grounded in compliance with the applicable local and national codes.
 - 6) Wiring shown are general points-of-connection guides only and are not intended for or to include all details for a specific installation.
 - 7) Be sure to install the switch and the fuse/breaker to the power line of each piece of equipment.
 - 8) Install the main switch that can interrupt all the power sources in an integrated manner because this system consists of the equipment utilizing the multiple power sources.
 - 9) If there exists the possibility of reversed phase, lost phase, momentary blackout or the power goes on and off while the product is operating, attach a reversed phase protection circuit locally.
- Running the product in reversed phase may break the compressor and other parts.

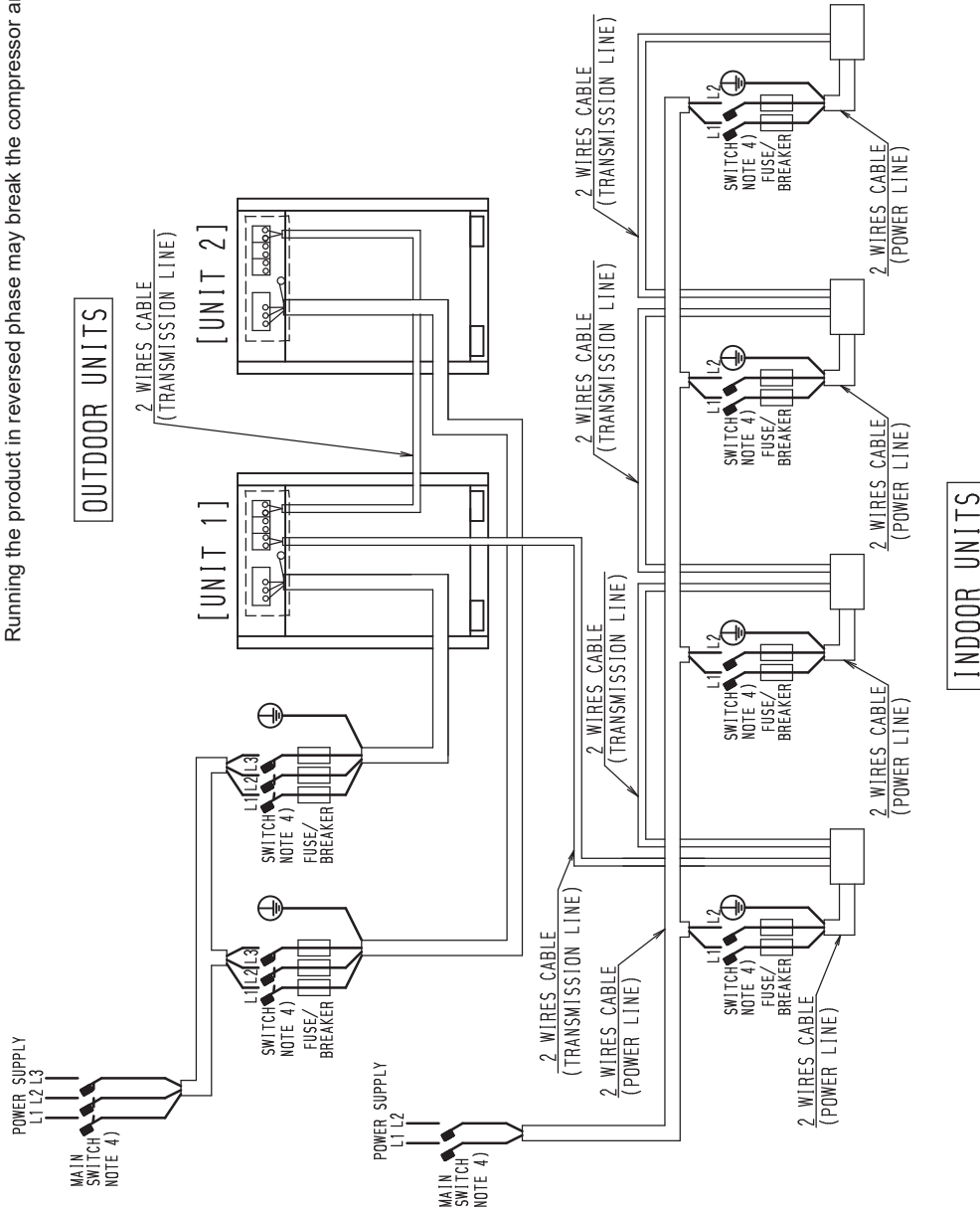

C: 3D087055C

9. Electrical Characteristics

RXLQ72 - 240TBTJA

Model name		Units				Power supply		Comp.	OFM		SCCR
		Hz	Volts	Min.	Max.	MCA	MOP	RLA	kW	FLA	
RXLQ72TBTJA		60	208/230	187	253	60.8	70	23.9	0.80 × 2	2.9 × 2	SCCR kA rms, Symmetrical @600 V MAX: 5
RXLQ96TBTJA		60	208/230	187	253	76.5	80	42.2	0.80 × 2	2.9 × 2	
RXLQ120TBTJA		60	208/230	187	253	83.4	90	41.4	0.80 × 2	2.9 × 2	
RXLQ144TBTJA	RXLQ72TBTJA	60	208/230	187	253	60.8 + 60.8	70 + 70	23.9 + 23.9	(0.80 × 2) × 2	(2.9 × 2) × 2	—
	RXLQ72TBTJA										
RXLQ192TBTJA	RXLQ96TBTJA	60	208/230	187	253	76.5 + 76.5	80 + 80	40.8 + 40.8	(0.80 × 2) × 2	(2.9 × 2) × 2	
	RXLQ96TBTJA										
RXLQ240TBTJA	RXLQ120TBTJA	60	208/230	187	253	83.4 + 83.4	90 + 90	41.7 + 41.7	(0.80 × 2) × 2	(2.9 × 2) × 2	
	RXLQ120TBTJA										

Symbols:

MCA: Min. Circuit Amps. (A)
 MOP: Max. Overcurrent Protector (A)
 RLA: Rated Load Amps. (A)
 OFM: Outdoor Fan Motor
 kW: Rated Motor Output (kW)
 FLA: Full Load Amps. (A)
 SCCR: Short-Circuit Current Rating

Notes:

- RLA is based on the following conditions.
 Indoor temp. 80°FDB (26.7°CDB) / 67°FWB (19.4°CWB)
 Outdoor temp. 95°FDB (35.0°CDB)
- Voltage range
 Units are designed to operate only at the rated voltage provided in the table above.
- The maximum percent unbalance of phase voltage shall be 2%.
- Select wire size based on the value of MCA.
- MOP is used to select the circuit breaker.
- Refer to electrical characteristics of each independent unit for SCCR.

RXLQ72 - 240TBYDA

Model name	Units				Power supply		Comp.	OFM		SCCR	
	Hz	Volts	Min.	Max.	MCA	MOP	RLA	kW	FLA		
RXLQ72TBYDA	60	460	416	508	28.1	35	10.4	0.6 × 2	1.0 × 2	SCCR kA rms, Symmetrical @600 V MAX: 5	
RXLQ96TBYDA	60	460	416	508	39.8	45	18.3	0.6 × 2	1.0 × 2		
RXLQ120TBYDA	60	460	416	508	43.4	50	18.0	0.6 × 2	1.0 × 2		
RXLQ144TBYDA	RXLQ72TBYDA RXLQ72TBYDA	60	460	416	508	28.1 + 28.1	35 + 35	10.4 + 10.4	(0.6 × 2) × 2	(1.0 × 2) × 2	—
RXLQ192TBYDA	RXLQ96TBYDA RXLQ96TBYDA	60	460	416	508	39.8 + 39.8	45 + 45	17.7 + 17.7	(0.6 × 2) × 2	(1.0 × 2) × 2	
RXLQ240TBYDA	RXLQ120TBYDA RXLQ120TBYDA	60	460	416	508	43.4 + 43.4	50 + 50	18.2 + 18.2	(0.6 × 2) × 2	(1.0 × 2) × 2	

Symbols:

MCA: Min. Circuit Amps. (A)
 MOP: Max. Overcurrent Protector (A)
 RLA: Rated Load Amps. (A)
 OFM: Outdoor Fan Motor
 kW: Rated Motor Output (kW)
 FLA: Full Load Amps. (A)

Notes:

- RLA is based on the following conditions.
 Indoor temp. 80°FDB (26.7°CDB) / 67°FWB (19.4°CWB)
 Outdoor temp. 95°FDB (35.0°CDB)
- Voltage range
 Units are designed to operate only at the rated voltage provided in the table above.
- The maximum percent unbalance of phase voltage shall be 2%.
- Select wire size based on the value of MCA.
- MOP is used to select the circuit breaker.
- Refer to electrical characteristics of each independent unit for SCCR.

RXLQ72 - 240TBYCA

Model name	Units				Power supply		Comp.	OFM		SCCR	
	Hz	Volts	Min.	Max.	MCA	MOP	RLA	kW	FLA		
RXLQ72TBYCA	60	575	518	632	21.6	25	8.3	0.7 × 2	1.0 × 2	SCCR kA rms, Symmetrical @600 V MAX: 5	
RXLQ96TBYCA	60	575	518	632	28.5	35	14.7	0.7 × 2	1.0 × 2		
RXLQ120TBYCA	60	575	518	632	31.2	40	14.4	0.7 × 2	1.0 × 2		
RXLQ144TBYCA	RXLQ72TBYCA	60	575	518	632	21.6 + 21.6	25 + 25	8.3 + 8.3	(0.7 × 2) × 2	(1.0 × 2) × 2	—
	RXLQ72TBYCA										
RXLQ192TBYCA	RXLQ96TBYCA	60	575	518	632	28.5 + 28.5	35 + 35	14.2 + 14.2	(0.7 × 2) × 2	(1.0 × 2) × 2	
	RXLQ96TBYCA										
RXLQ240TBYCA	RXLQ120TBYCA	60	575	518	632	31.2 + 31.2	40 + 40	14.5 + 14.5	(0.7 × 2) × 2	(1.0 × 2) × 2	
	RXLQ120TBYCA										

Symbols:

MCA: Min. Circuit Amps. (A)

MOP: Max. Overcurrent Protector (A)

RLA: Rated Load Amps. (A)

OFM: Outdoor Fan Motor

kW: Rated Motor Output (kW)

FLA: Full Load Amps. (A)

Notes:

1. RLA is based on the following conditions.
Indoor temp. 80°FDB (26.7°CDB) / 67°FWB (19.4°CWB)
Outdoor temp. 95°FDB (35.0°CDB)
2. Voltage range
Units are designed to operate only at the rated voltage provided in the table above.
3. The maximum percent unbalance of phase voltage shall be 2%.
4. Select wire size based on the value of MCA.
5. MOP is used to select the circuit breaker.
6. Refer to electrical characteristics of each independent unit for SCCR.

10. Operation Limits

RXLQ72 - 240TBTJA / TBYDA / TBYCA

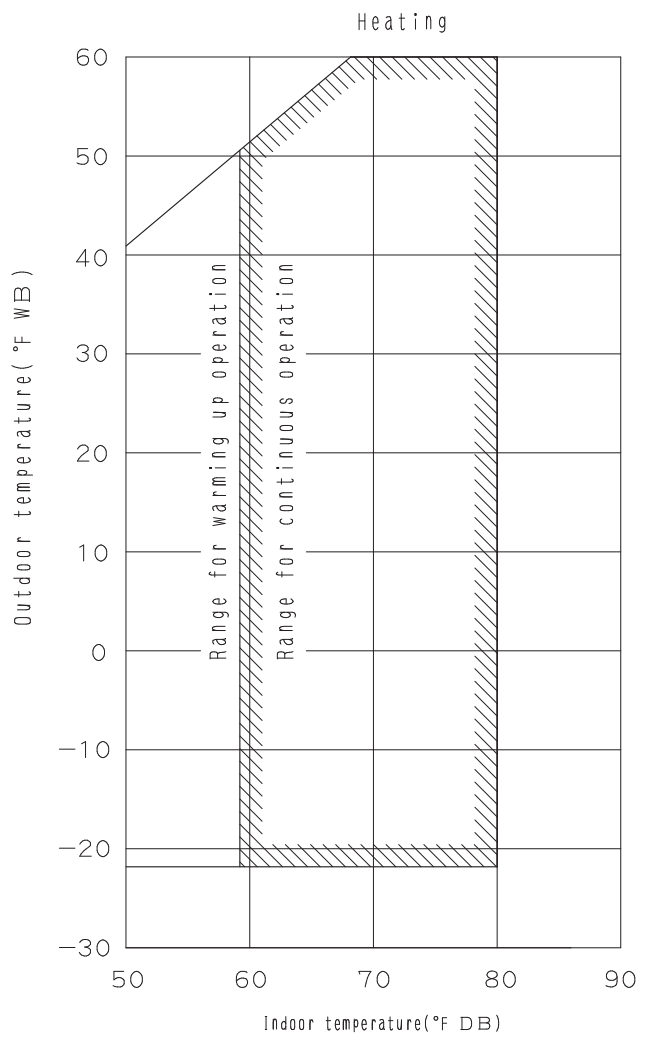
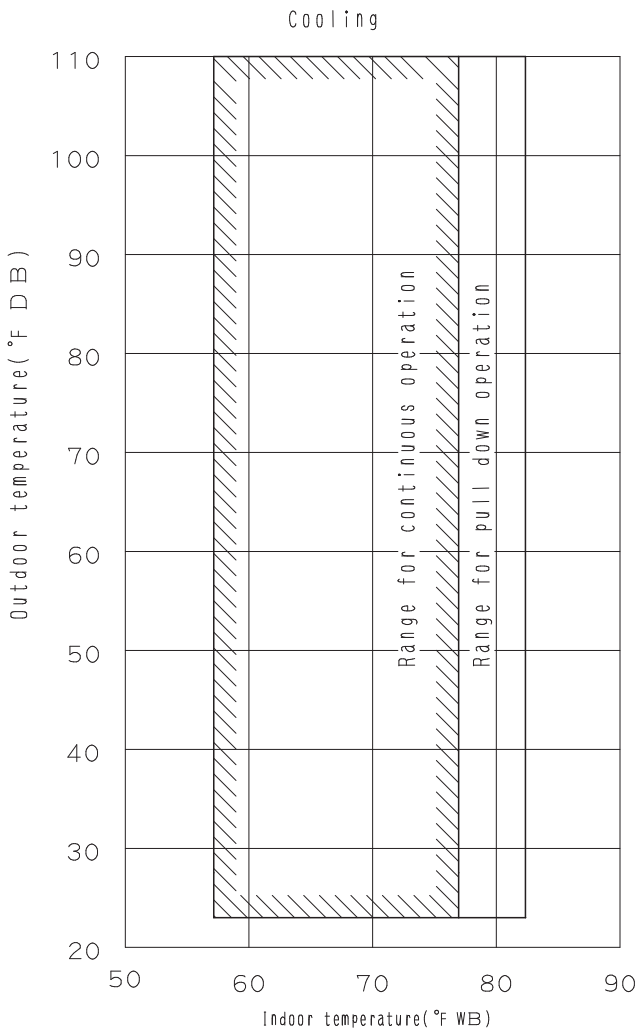

11. Sound Levels (Reference Data)

RXLQ72TBTJA / TBYDA / TBYCA

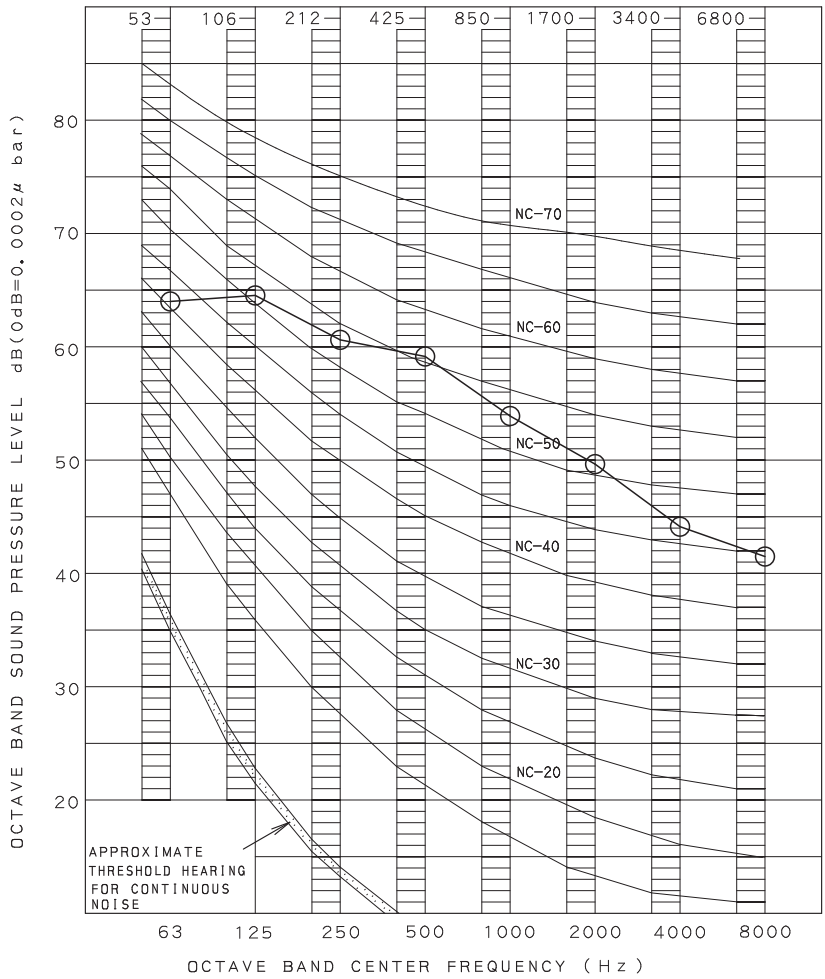

OVER ALL (dB)

OPERATING CONDITIONS

SCALE	60Hz
A	60

POWER SOURCE 208/230V, 460V, 575V 60Hz

(B, G, N IS ALREADY RECTIFIED)

MEASURING PLACE

LOCATION OF MICROPHONE

ANECHOIC CHAMBER (CONVERSION VALUE)

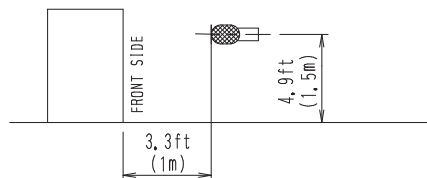

NOTE: THE OPERATING SOUND IS MEASURED IN ANECHOIC CHAMBER, IF IT IS MEASURED UNDER THE ACTUAL INSTALLATION CONDITIONS, IT IS NORMALLY OVER THE SET VALUE DUE TO ENVIRONMENTAL NOISE AND SOUND REFLECTION.

RXLQ96TBTJA / TBYDA / TBYCA

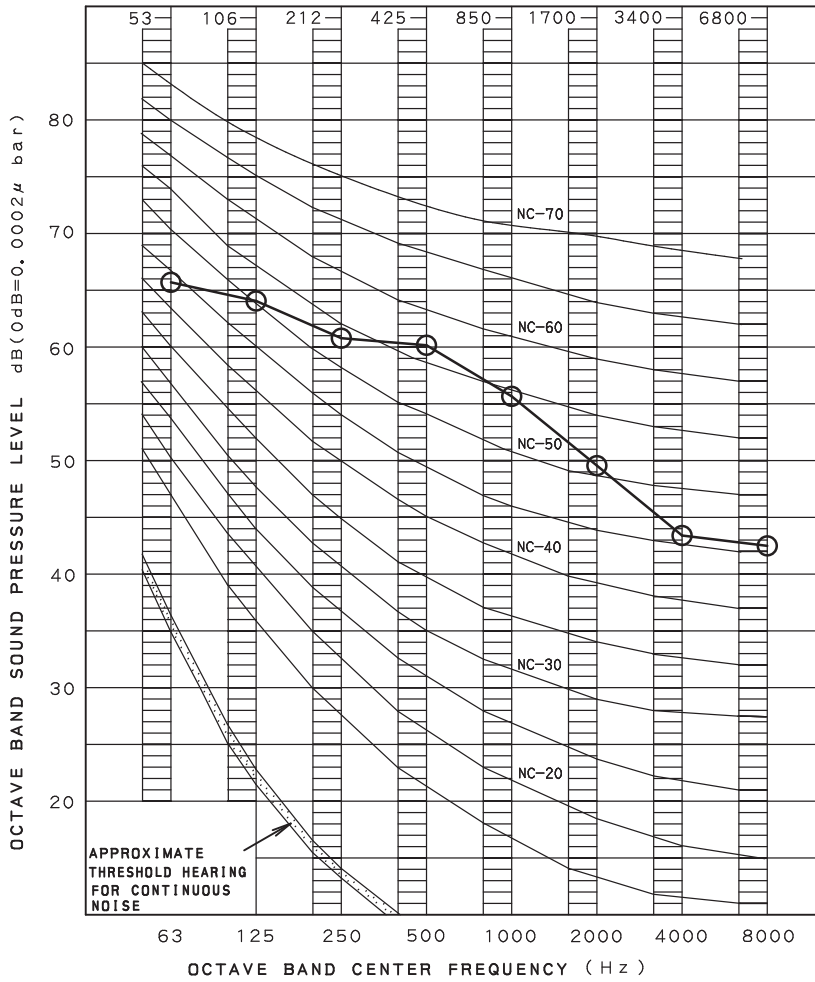

OVER ALL (dB)

SCALE	60Hz
A	61

(B, G, N IS ALREADY RECTIFIED)

OPERATING CONDITIONS

POWER SOURCE 208/230V, 460V, 575V 60Hz

MEASURING PLACE

ANECHOIC CHAMBER (CONVERSION VALUE)

LOCATION OF MICROPHONE

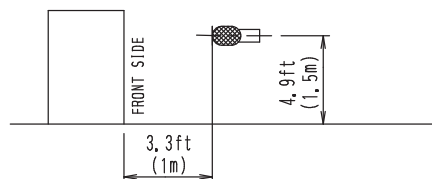

NOTE: THE OPERATING SOUND IS MEASURED IN ANECHOIC CHAMBER, IF IT IS MEASURED UNDER THE ACTUAL INSTALLATION CONDITIONS, IT IS NORMALLY OVER THE SET VALUE DUE TO ENVIRONMENTAL NOISE AND SOUND REFLECTION,

RXLQ120TBTJA / TBYDA / TBYCA

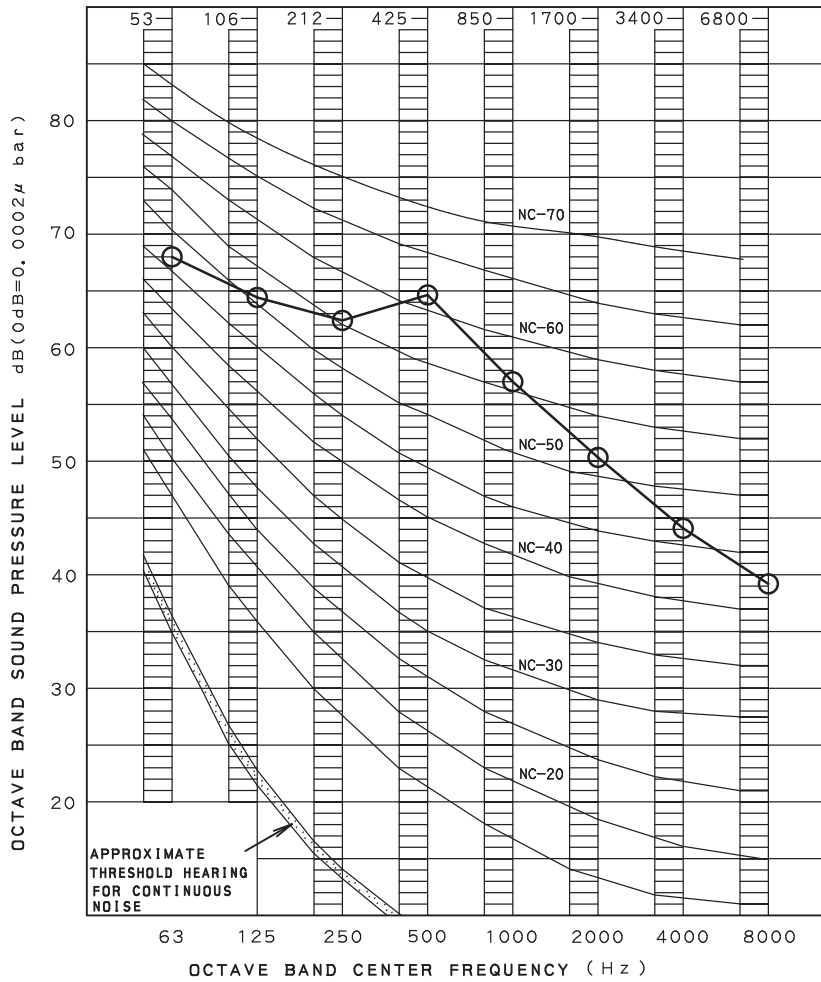

OVER ALL (dB)

SCALE	60Hz
A	63.5

(B, G, N IS ALREADY RECTIFIED)

OPERATING CONDITIONS

POWER SOURCE 208/230V, 460V, 575V 60Hz

MEASURING PLACE

ANECHOIC CHAMBER (CONVERSION VALUE)

LOCATION OF MICROPHONE

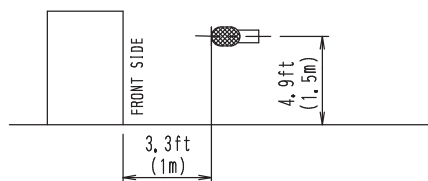

NOTE: THE OPERATING SOUND IS MEASURED IN ANECHOIC CHAMBER, IF IT IS MEASURED UNDER THE ACTUAL INSTALLATION CONDITIONS, IT IS NORMALLY OVER THE SET VALUE DUE TO ENVIRONMENTAL NOISE AND SOUND REFLECTION.

12. Accessories

12.1 Optional Accessories

RXLQ72 - 240TBTJA / TBYDA / TBYCA

Optional accessories		RXLQ72TBTJA RXLQ96TBTJA RXLQ72TBYDA RXLQ96TBYDA RXLQ72TBYCA RXLQ96TBYCA	RXLQ120TBTJA RXLQ120TBYDA RXLQ120TBYCA	RXLQ144TBTJA RXLQ192TBTJA RXLQ240TBTJA RXLQ144TBYDA RXLQ192TBYDA RXLQ240TBYDA RXLQ144TBYCA RXLQ192TBYCA RXLQ240TBYCA
Distributive piping	REFNET header	(Max. 4 branch) KHRP26M22H9 KHRP26M22HA (Max. 8 branch) KHRP26M33H9 KHRP26M33HA	(Max. 4 branch) KHRP26M22H9 KHRP26M22HA (Max. 8 branch) KHRP26M33H9 KHRP26M33HA KHRP26M72H9 KHRP26M72HA	(Max. 4 branch) KHRP26M22H9 KHRP26M22HA (Max. 8 branch) KHRP26M33H9 KHRP26M33HA KHRP26M72H9 KHRP26M72HA KHRP26M73HU9 KHRP26M73HUA
	REFNET joint	KHRP26A22T9 KHRP26A22TA KHRP26A33T9 KHRP26A33TA	KHRP26A22T9 KHRP26A22TA KHRP26A33T9 KHRP26A33TA KHRP26M72TU9 KHRP26M72TUA	KHRP26A22T9 KHRP26A22TA KHRP26A33T9 KHRP26A33TA KHRP26M72TU9 KHRP26M72TUA KHRP26M73TU9 KHRP26M73TUA
Outdoor unit multi connection piping kit		-		BHFP22P100U BHFP22P100UA

C: 3D087057E

13. Selection Procedure

13.1 Selection Procedure

Flowchart

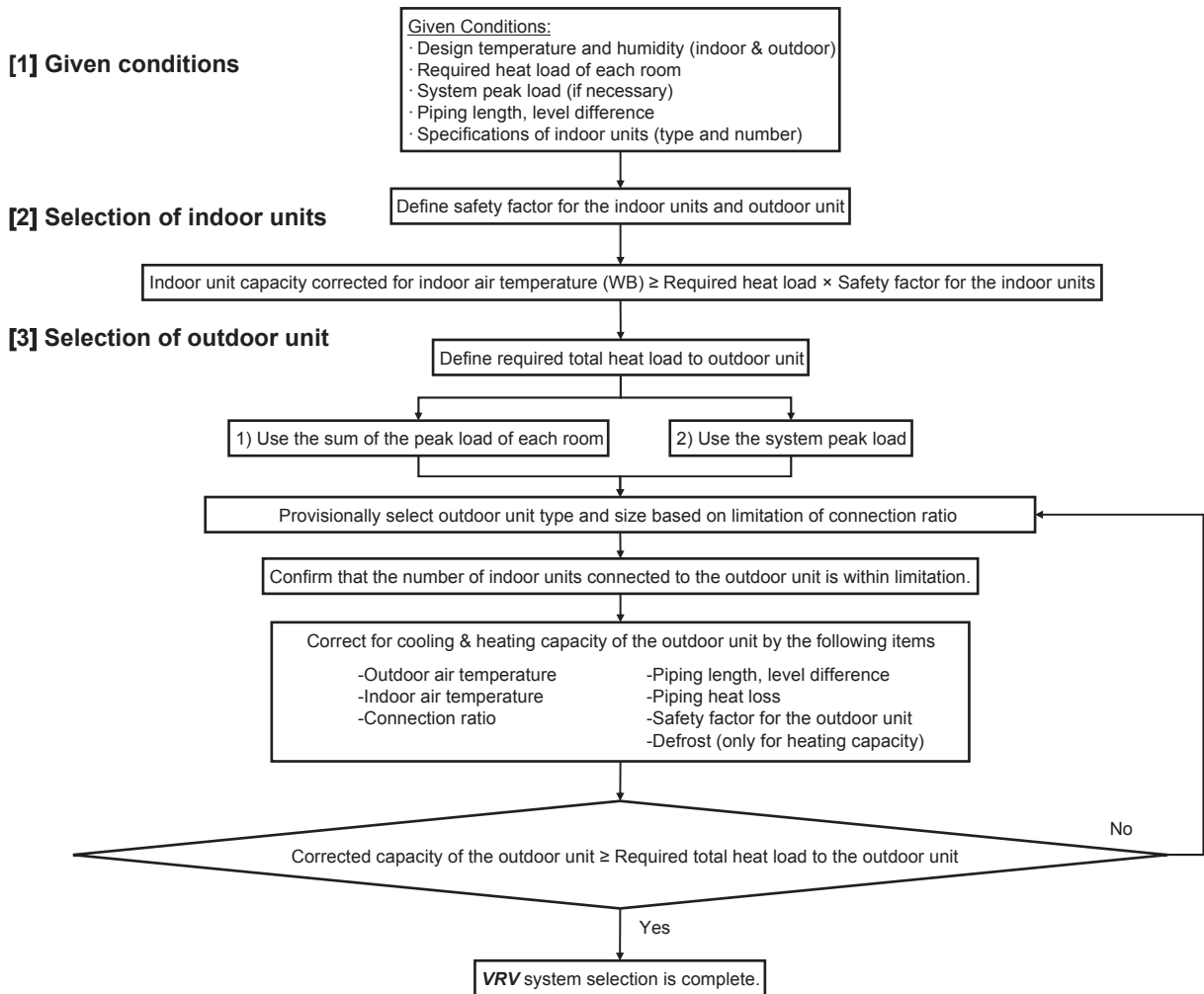

Selection Example

The following is a selection example based on total heat load for cooling.

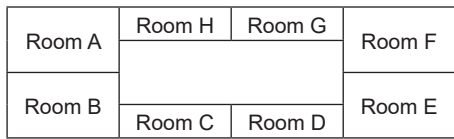

Floor plan

[1] Given conditions

-Design conditions

Indoor air temperature: 67°F WB / 80°F DB, Outdoor air temperature: 93°F DB

-Determine peak load of each room (and system peak load if necessary)

-Required heat load of each room

Time	Room A	Room B	Room C	Room D	Room E	Room F	Room G	Room H	Total
9:00	16.4	16.5	10.4	10.4	30.9	30.8	10.0	10.0	135.4
12:00	22.4	24.4	17.3	17.3	25.1	23.2	13.7	13.7	157.1
14:00	30.7	32.2	16.8	16.8	24.9	23.4	14.1	14.1	173.0
16:00	36.1	36.4	13.3	13.3	21.5	21.2	13.0	13.0	167.8

Total heat load (MBH)

From the above heat load calculation, the maximum heat load for the system (system peak load) is 173.0 MBH.

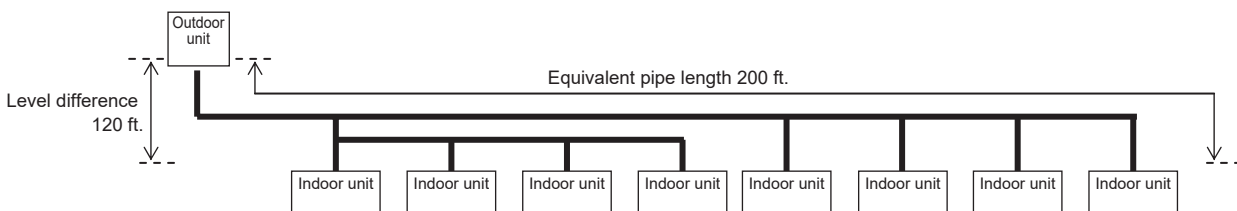

Select **VRV** indoor units FXMQ-TB series for each room.

-Safety factor

In this example, safety factor is not used. (i. e., safety factor = 1.0)

[2] Selection of indoor units

Calculate total heat capacity of indoor units corrected for indoor air temperature.

In case design temperature of the indoor air falls between temperatures listed in the table, calculate the capacity by interpolation.

The corrected total heat capacity of indoor units shall satisfy the maximum heat load of each room.

Capacity table of indoor unit
Cooling Capacity

Model	Indoor air temp. °FWB (°CWB) (Te: 43°F (6°C))											
	61 (16.1)		64 (17.8)		67 (19.4)		70 (21.1)		72 (22.2)		75 (23.9)	
	TC	SHC	TC	SHC	TC	SHC	TC	SHC	TC	SHC	TC	SHC
	MBH	MBH	MBH	MBH	MBH	MBH	MBH	MBH	MBH	MBH	MBH	MBH
FXMQ15TBVJU	11.4	9.3	12.9	10.2	14.2	10.4	14.5	10.1	14.6	10.0	14.8	9.5
FXMQ18TBVJU	14.5	12.3	16.3	13.5	18.0	13.8	18.4	13.5	18.7	13.3	18.8	13.0
FXMQ24TBVJU	19.3	15.0	21.9	16.6	24.0	16.8	24.4	16.4	24.7	16.1	25.1	15.6
FXMQ30TBVJU	24.2	20.0	27.6	22.2	30.0	22.4	30.6	21.8	31.0	21.4	31.6	20.8
FXMQ36TBVJU	29.1	22.9	33.0	25.2	36.0	25.7	36.7	25.1	37.2	24.7	37.9	23.9
FXMQ48TBVJU	38.8	30.7	44.1	33.9	48.0	34.8	49.0	33.9	49.7	33.4	50.5	32.2
FXMQ54TBVJU	46.1	36.9	52.5	40.9	57.0	41.8	58.2	40.8	59.1	40.2	59.9	38.6

TC: Total capacity: MBH

SHC: Sensible heat capacity: MBH

Selection results of indoor units

	Room A	Room B	Room C	Room D	Room E	Room F	Room G	Room H
Max. heat load (MBH)	36.1	36.4	17.3	17.3	30.9	30.8	14.1	14.1
Selected IDU	FXMQ48TBVJU	FXMQ48TBVJU	FXMQ18TBVJU	FXMQ18TBVJU	FXMQ36TBVJU	FXMQ36TBVJU	FXMQ15TBVJU	FXMQ15TBVJU
Corrected TC (MBH)	48.0	48.0	18.0	18.0	36.0	36.0	14.2	14.2

* In case of selection based on Total Heat Load and Sensible Heat Load, select indoor units which satisfy not only the Total Heat Load but also the Sensible Heat Load of each room. The sensible heat capacity of indoor units is to be corrected for indoor air temperature. If the design temperature of indoor air falls between temperatures listed in table, calculate sensible heat capacity by using the bypass factor calculated by interpolation for each indoor air temperature.

[3] Selection of outdoor unit

[3] -1 Define the required total heat load from the indoor units to the outdoor unit

Define the required total heat load (A) based on (1) the sum of the peak load of each room or (2) the system peak load.

In this example, select an outdoor unit by (2).

Therefore, (A) = 173.0 MBH

[3] –2 Provisionally select outdoor unit

(1) Calculate CI (Capacity Index) of the selected indoor units.

CI of **VRV** indoor units
 CI of FXMQ15TBVJU = 15
 CI of FXMQ18TBVJU = 18
 CI of FXMQ36TBVJU = 36
 CI of FXMQ48TBVJU = 48

Capacity Range	0.5 ton	0.6 ton	0.8 ton	1 ton	1.25 ton	1.5 ton	2 ton	2.5 ton	3 ton	3.5 ton	4 ton	4.5 ton	5 ton	6 ton	8 ton	Power Supply, Standard
Capacity Index	5.8	7.5	9.5	12	15	18	20	24	30	36	42	48	54	60	72	96
HSP concealed ducted unit	FXMQ	—	—	—	15TB	18TB	—	24TB	30TB	36TB	—	48TB	54TB	—	—	VJU

Calculate the total CI of the indoor units.
 Total CI = 15 × 2 + 18 × 2 + 36 × 2 + 48 × 2 = 234

(2) Provisionally select an outdoor unit based on the total CI of the indoor units

The connection ratio of RXLQ-TA shall be between 70% and 130%.
 As the total CI of the indoor units is 234, outdoor units from 16 ton to 20 ton are connectable.
 Start from 16 ton which is the smallest outdoor unit.

Type	Ton	Capacity index	Model name	Combination	Outdoor unit multi connection piping kit *1	Total capacity index of connectable indoor units *2	Maximum number of connectable indoor units
Single outdoor unit	6	72	RXLQ72TB	RXLQ72TB	—	51 to 93 (144)	12
	8	96	RXLQ96TB	RXLQ96TB		68 to 124 (192)	16
	10	120	RXLQ120TB	RXLQ120TB		84 to 156 (240)	20
Double outdoor units	12	144	RXLQ144TB	RXLQ72TB+RXLQ72TB	BHFP22P100U BHFP22P100UA	101 to 187 (230)	25
	16	192	RXLQ192TB	RXLQ96TB+RXLQ96TB		135 to 249 (307)	33
	20	240	RXLQ240TB	RXLQ120TB+RXLQ120TB		168 to 312 (384)	41

(3) Confirm that the number of the connected indoor units is within the limitation.

The number of the connected indoor units = 8
 The max. number of connectable indoor units of 16 ton outdoor unit = 33

[3] –3 Calculate the corrected capacity of the outdoor unit.

-Calculate the connection ratio of the system.
 Total CI = 234, CI of RXLQ192TB YCA = 192
 Combination ratio = 234 / 192 = 122%

-Using the capacity table of the outdoor unit, calculate the capacity (B) corrected for outdoor air temperature, indoor air temperature, and combination ratio.

* In case the outdoor air temperature, the indoor air temperature, or the connection ratio falls between temperatures listed in the table, calculate the capacity by interpolation.

RXLQ192BTJA / TB YDA / TB YCA Cooling Capacity for Standard Condition (Te: 43°F)

Combi- nation	Outdoor air temp.	Indoor air temp. (°FWB)															
		57		61		64		67		70		72		75			
		TC	PI	TC	PI	TC	PI	TC	PI	TC	PI	TC	PI	TC	PI		
%	°FDB	MBH	kW	MBH	kW	MBH	kW	MBH	kW	MBH	kW	MBH	kW	MBH	kW	MBH	kW
130	23	146	4.71	188	6.20	219	7.38	250	8.60	271	9.50	275	9.55	281	9.63		
	30	146	4.86	188	6.40	219	7.63	250	8.94	265	9.63	269	9.68	275	9.76		
	40	146	5.08	188	6.71	219	8.00	250	9.67	256	9.81	260	9.86	266	9.95		
	50	146	5.33	188	7.05	219	8.59	242	9.91	248	10.0	251	10.1	257	10.1		
	54	146	5.44	188	7.20	219	8.88	238	9.98	244	10.1	248	10.1	254	10.2		
	58	146	5.55	188	7.36	219	9.18	235	10.1	241	10.1	245	10.2	250	10.3		
	62	146	5.66	188	7.59	219	9.50	231	10.1	237	10.2	241	10.3	247	10.4		
	66	146	5.79	188	7.85	219	9.83	228	10.2	234	10.3	238	10.4	243	10.5		
	70	146	5.91	188	8.26	219	10.4	224	10.5	230	10.6	234	10.6	240	10.7		
	72	146	6.06	188	8.58	217	10.6	223	10.7	229	10.8	232	10.9	238	11.0		
	75	146	6.41	188	9.09	214	11.0	220	11.1	226	11.2	230	11.3	236	11.4		
	79	146	6.89	188	9.79	211	11.5	217	11.7	222	11.8	226	11.8	232	12.0		
	83	146	7.40	188	10.5	207	12.1	213	12.2	219	12.3	223	12.4	229	12.5		
	87	146	7.94	188	11.3	204	12.6	210	12.7	216	12.9	219	12.9	225	13.1		
	91	146	8.51	188	12.2	200	13.1	206	13.3	212	13.4	216	13.5	219	13.6		
93	146	8.81	188	12.6	199	13.2	205	13.5	210	13.7	214	13.8	215	13.8			
95	146	9.12	188	13.1	197	13.7	203	13.8	209	14.0	210	14.0	210	14.0			
99	146	9.76	188	14.0	194	14.2	199	14.4	202	14.4	202	14.4	202	14.4			
103	146	10.5	184	14.6	190	14.7	193	14.8	193	14.8	193	14.8	193	14.8			
106	146	11.1	182	15.2	187	15.3	187	15.3	187	15.3	187	15.3	187	15.3			
110	146	12.2	178	16.0	178	16.0	178	16.0	178	16.0	178	16.0	178	16.0			
115	146	13.5	154	17.0	154	17.0	155	17.0	155	17.0	155	17.1	155	17.1			
118	133	13.9	134	13.9	134	13.9	134	14.0	135	14.0	135	14.0	135	14.0			
122	107	9.83	107	9.85	107	9.87	108	9.89	108	9.91	108	9.92	108	9.94			
120	23	135	4.33	173	5.66	202	6.73	230	7.84	259	8.98	271	9.50	276	9.57		
	30	135	4.46	173	5.84	202	6.95	230	8.10	259	9.45	264	9.62	270	9.69		
	40	135	4.66	173	6.13	202	7.29	230	8.58	252	9.75	256	9.80	261	9.88		
	50	135	4.88	173	6.44	202	7.67	230	9.29	244	9.94	247	9.99	252	10.1		
	54	135	4.98	173	6.57	202	7.90	230	9.60	240	10.0	244	10.1	249	10.1		
	58	135	5.08	173	6.71	202	8.16	230	9.93	237	10.1	240	10.1	246	10.2		
	62	135	5.18	173	6.85	202	8.43	228	10.1	233	10.2	237	10.2	242	10.3		
	66	135	5.29	173	7.00	202	8.72	224	10.1	230	10.2	233	10.3	239	10.4		
	70	135	5.41	173	7.36	202	9.19	221	10.4	226	10.5	230	10.6	235	10.6		
	72	135	5.47	173	7.65	202	9.55	219	10.7	224	10.8	228	10.8	233	10.9		
	75	135	5.76	173	8.09	202	10.1	217	11.1	222	11.2	225	11.2	231	11.3		
	79	135	6.19	173	8.72	202	10.9	213	11.6	218	11.7	222	11.8	227	11.9		
	83	135	6.64	173	9.38	202	11.8	210	12.1	215	12.2	219	12.3	224	12.4		
	87	135	7.12	173	10.1	201	12.5	206	12.6	211	12.8	215	12.8	220	13.0		
	91	135	7.62	173	10.8	197	13.1	203	13.2	208	13.3	212	13.4	217	13.5		
93	135	7.89	173	11.2	196	13.2	201	13.5	206	13.6	210	13.7	215	13.8			
95	135	8.16	173	11.6	194	13.6	199	13.7	205	13.9	208	13.9	210	14.0			
99	135	8.73	173	12.5	190	14.1	196	14.3	201	14.4	202	14.4	202	14.4			
103	135	9.34	173	13.4	187	14.7	192	14.8	193	14.8	193	14.8	193	14.8			
106	135	9.96	173	14.3	184	15.3	187	15.3	187	15.3	187	15.3	187	15.3			
110	135	10.9	173	15.6	178	16.0	178	16.0	178	16.0	178	16.0	178	16.0			
115	135	12.1	154	17.0	154	17.0	155	17.0	155	17.0	155	17.1	155	17.1			
118	133	13.9	134	13.9	134	13.9	134	14.0	135	14.0	135	14.0	135	14.0			
122	107	9.83	107	9.85	107	9.87	108	9.89	108	9.91	108	9.92	108	9.94			

Connection ratio	120%	122%	130%
Cooling capacity	201	(B)	205

(B) = 201 + (205 – 201) × (122 – 120) / (130 – 120)
 = 201.8

14. Caution Label

14.1 RXLQ72-120TBTJA / TBYDA / TBYCA

RXLQ72 - 120TBTJA / TBYDA / TBYCA

Service Precautions (1/2) (Touch the noncoated metal part to eliminate static electricity before performing service (e.g. the control box cover).)

CAUTION when performing service inside the control box

⚠ WARNING ⚠ Caution for electric shock

1. Make sure to turn off the power supply before remove the control box cover. (Touching electric parts may cause electric shock.)
2. Do not open the control box cover for 10 minutes after the power supply is turned off.
3. Measure the voltage between terminals on the terminal block for power supply with a tester and confirm that the power supply is turned off. In addition, measure the points shown below with a tester and confirm that the voltage of the capacitor in the main circuit is less than DC 50V.
4. To prevent a damage of the printed circuit boards, touch the noncoated metal part and make sure to eliminate static electricity before pulling out or plugging in the connector.
5. The work must be started after pulling out the junction connector X1A · X2A · X3A · X4A(X3A X4A are nothing according to the model. Please see wiring diagram for details.) for the fan motor in the outdoor unit and be careful not to touch the energized parts. (If the fan rotates by strong wind, it may cause storage of electricity in the capacitor in the main circuit and electric shock.)
6. After the service is finished, plug in the junction connector.

- For details, see the wiring diagram label on the back of the control box cover.
- Otherwise, malfunction code "E7" will be displayed on 7 segment display of outdoor unit printed circuit board (A1P) and in the remote controller due to wrong connection, and normal operation will not be performed.

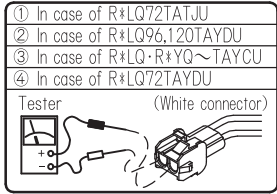
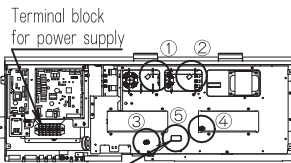
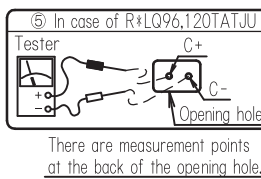

⚠ After service is complete, make sure to close the control box cover. (Water soaking or foreign object may cause failure.)

CAUTION for piping work and additional refrigerant charge

- Use the charging hose and gauge manifold designed for R410A in order to withstand the pressure and prevent impurities (such as SUNISO oil) from mixing into.
- Carry out a nitrogen blow when brazing.
- Perform the air tightness and the vacuum drying certainly. (The air tightness test pressure: 550 psi, make sure to use nitrogen gas.)
- Charge the additional refrigerant in liquid state.

CAUTION while check operation

- Make sure to turn on the power supply of all connected units (indoor · BS · outdoor) before operation.
- Make sure to close all outer panels when operating. Otherwise, the system cannot be checked properly.

CAUTION for removing and installing the control box cover

[Method of removal]

- ① Remove the 6 screws fixing the cover.
- ② Pull the cover forward.
- ③ Slide the cover downward until the upper tip appears.

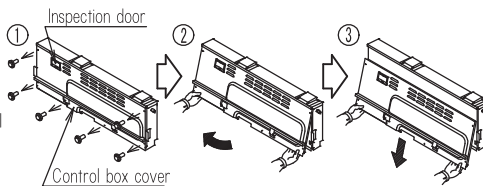

[Method of installation]

For installing the cover, follow the [Method of removal] in the reverse order.

[CAUTION]

- Do not remove the cover by force, if the cover is deformed, water may enter inside, which may cause failure.
- Install the cover so that the sealing material does not get caught in control box. (See the right figure.)

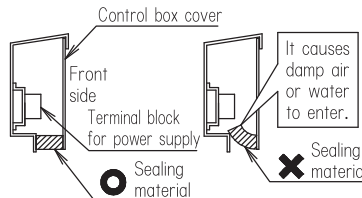

⚠ DANGER **ELECTRIC SHOCK HAZARD!**
 DISCONNECT ALL REMOTE POWER SUPPLIES BEFORE INSTALLING OR SERVICING THIS EQUIPMENT.
 Failure to do so could lead to serious injury or death. Only a qualified service technician should install or service this equipment.

DANGER D' ELECTROCUTION!
 DÉCONNECTER TOUTES LES ALIMENTATIONS ÉLECTRIQUES ÉLOIGNÉES AVANT D'INSTALLER OU DE REPARER CET APPAREIL.
 Le non respect de cette recommandation peut entraîner des blessures graves ou la mort. Seul un technicien de service qualifié peut installer ou réparer cet appareil.

Service precautions (2/2)

Field setting

If required, carry out the field setting according to the following instructions. For details, see the service manual.

1. How to operate

- When setting the DIP switch, make sure to turn off the power supply and open the control box cover.
- For operating the push button switch, open the inspection door as shown in the below figure with the power supply turned on, and use a resin ballpoint or non-conducting object.
- After the work is finished make sure to close the inspection door.

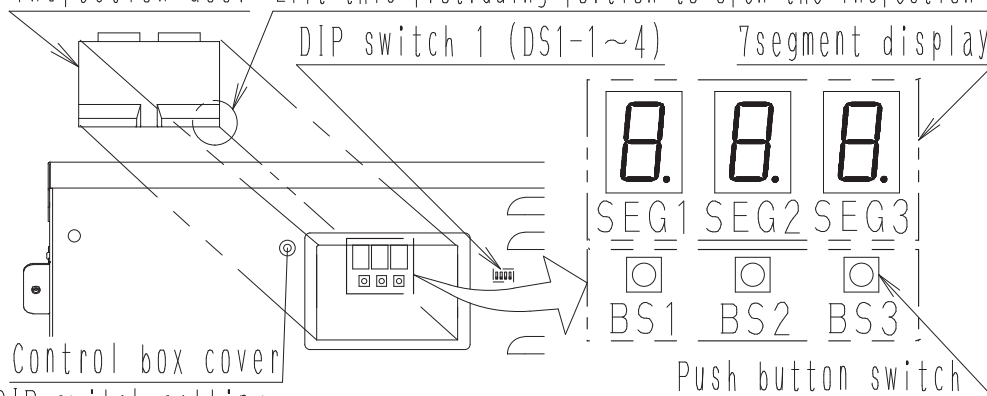

2. DIP switch setting

NO.	Setting item	Setting value
DS1-1	Cool/Heat switching setting (Note)	ON (when connecting COOL/HEAT selector) OFF (factory setting)
DS1-2~4		Not change from factory setting (OFF)

(Note) COOL/HEAT selector (optional accessory) installing in the outdoor unit is enable to switch operation mode (cooling/heating).
For details of COOL/HEAT selector (optional accessory) installation method, see its installation manual.

3. Setting by the push button switch(BS1~3)

●Function of the push switch

Push button	Button types	Use
BS1	New page button	For changing setting mode
BS2	Operation button	For changing field setting
BS3	Confirmation button	
BS2 long push	Operation button	For check operation
BS3 long push	Confirmation button	For resetting the address when the wiring is changed or additional indoor unit is installed

●Normal Mode, Setting Mode, Confirmation mode change method

Push new page button(BS1). It can switch confirmation mode, normal mode and setting mode.

[Setting mode] can use for setting (A) ~ (H) as shown in right table.

[Confirmation mode] can use for confirmation of (J) • (K) items as shown in right table.

(Note) About other settings and malfunction code, see the service manual.

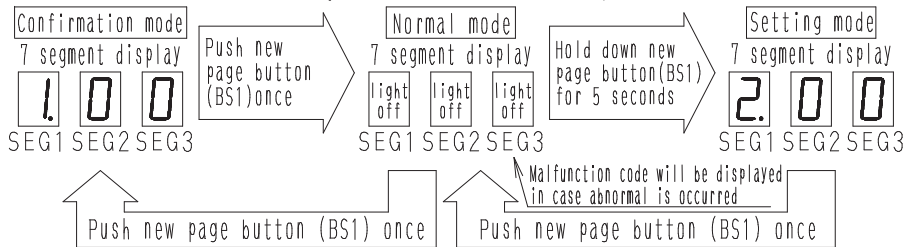

!
If you get confused in the setting process, push new page button(BS1), then the system return to initial state (Normal mode).

- For each type setting, make sure to set the master unit, Sub unit setting is invalid.
- Outdoor unit which connect with indoor units by transmission wiring is master unit, other are sub units.
- Master unit and sub unit can be distinguished by 7 segment display according to operation below.

		7 Segment display			
		SEG1	SEG2	SEG3	
(1)	In [Normal mode], push new page button (BS1) and change to [Confirmation mode]. Confirm 7 segment display show right description,	1	0	0	
(2)	Push confirmation button(BS3) and confirm the unit master or sub. (see right)	Master unit	light off	light off	0
		Sub unit 1	light off	light off	1
		Sub unit 2	light off	light off	2

Set [Setting mode] or [Confirmation mode] first, then perform procedure below,		Details of setting	7 Segment display															
			SEG1	SEG2	SEG3													
Setting procedure	① Push operation button (BS2) and adjust the 7 segment display to require mode shown in right, (*1) For selecting low noise operation or demand operation from outside, or performing cool/heat setting by cool/heat central remote control, external control adapter for outdoor unit (optional accessory) is required. For details, see the instruction attached to the adapter.	Ⓐ Cool/Heat selection setting (*1)	2	0	0													
		Ⓑ Additional refrigerant charge operation setting	2	2	0													
		Ⓒ Refrigerant recovery operation/Evacuation mode setting,	2	2	1													
		Ⓓ Night time low noise setting	2	2	2													
		Ⓔ External low noise level setting(*1)	2	2	5													
		Ⓕ Demand level setting(*1)	2	3	0													
		Ⓖ External low noise demand setting (*1)	2	1	2													
		Ⓖ High static pressure setting	2	1	8													
		② Push confirmation button (BS3). (The present setting is indicated,)	Either of ③															
	③ Push operation button (BS2) and adjust the 7 segment display to required mode shown in right, (*2) Setting level efficiency <table border="1" style="margin-left: 20px;"> <tr> <td>For Ⓓ and Ⓔ</td> <td>Setting value</td> <td>level 1 ~ level 3</td> </tr> <tr> <td>Ⓔ</td> <td>Noise value</td> <td>→ low noise</td> </tr> <tr> <td>For Ⓕ</td> <td>Setting value</td> <td>level 1 ~ level 8</td> </tr> <tr> <td></td> <td>Power consumption</td> <td>less power ←</td> </tr> </table> For details, see the service manual.	For Ⓓ and Ⓔ	Setting value	level 1 ~ level 3	Ⓔ	Noise value	→ low noise	For Ⓕ	Setting value	level 1 ~ level 8		Power consumption	less power ←	For Ⓐ	For perform individual cool/heat switching	light off	light off	0
		For Ⓓ and Ⓔ	Setting value	level 1 ~ level 3														
		Ⓔ	Noise value	→ low noise														
		For Ⓕ	Setting value	level 1 ~ level 8														
			Power consumption	less power ←														
		For cool/heat switching by master unit	light off	light off	1													
	For cool/heat switching by sub unit	light off	light off	2														
	For ⒷⒸ	ON	light off	light off	1													
	ⒸⒹ	OFF (Factory setting)	light off	light off	0													
	For Ⓓ	OFF (Factory setting)	light off	light off	0													
	Ⓔ (*2)	level A(*3) (*3) A is a number of 1~3	light off	light off	A(*3)													
	For Ⓕ	level A(*3) (*3) A is a number of 1~3 (Factory setting :2)	light off	light off	A(*3)													
	Ⓖ (*2)	level B(*4) (*4) B is number of 1~8 (Factory setting :3)	light off	light off	B(*3)													
④ Push confirmation button(BS3),	The setting in ③ is defined				It will turn to light ON.													
⑤ Push confirmation button again (BS3).	The system start the operation according to the setting,				2 0 0													
⑥ Push new page button(BS1),	The system return to normal mode,				light off light off light off													
Confirmation procedure	① Push operation button(BS2) according to confirmation item (Ⓔ,Ⓕ) and adjust the 7 segment display to the example shown on the right according to the required mode.	Ⓔ Low noise operation	1	0	1													
		Ⓕ Demand operation	1	0	2													
	② Push confirmation button (BS3). (The present setting will be indicate,)	During setting operation	light off	light off	1													
	During normal operation,	light off	light off	0														

Additional refrigerant charge operation

- When the outdoor unit is stopped and the entire quantity of refrigerant can not be charged, make sure to charge the remaining quantity of refrigerant using this procedure. If the refrigerant quantity is insufficient, the unit may malfunction.



Setting procedure

- ① Connect the refrigerant charge hose and valve to the stop valve service port on the gas side,
- ② Make sure to completely open the stop valve on the gas side and the liquid side.
- ③ Turn ON the power of the indoor units and the outdoor unit. To protect the compressor, make sure to turn on the power supply for 6 hours before starting operation.

- ④ In the state of unit stopped, turn on the additional refrigerant charge operation by [Setting mode], and open refrigerant cylinder valve. About valve pulse, make sure to adjust refrigerant charging speed as 2.2 lb/minute.

- The operation is automatically started, 7 segment display will be changed as shown in right(up) and "Test operation" and "Under centralized control" are displayed in the remote controller.
- Low pressure indication may display on 7 segment display (as shown in right(down)), however, operation can be carried out continuously.

Test operation •
Under centralized control
7 segment display

 → 
When start When finish

Example 7 Segment display
0.17 MPa ⇒ 

- ⑤ After charging the specified quantity of refrigerant, close refrigerant cylinder valve, push confirmation button(BS3),
 - The operation will be stopped. The operation is automatically stopped within 30 minutes. If charging is not completed, set and perform the additional refrigerant charging operation again.
 - If the additional refrigerant charging operation is stopped soon, the refrigerant may be overcharged. Stop additional charging and make sure to confirm charged amount again.

Check operation method

! Make sure to open the gas side and liquid side stop valve before starting operation.

- The items below are automatically checked by check operation.
 - ◆ Check of wrong wiring ◆ Check of stop valve closing ◆ Check of refrigerant overcharge ◆ Detection of piping length.
- For multi system, make sure to confirm setting and result indication by master unit.
- Make sure to carry out the check operation after the first installation. Otherwise, the malfunction code "U3" will be displayed in the remote controller and normal operation can not be carried.
- The check operation is automatically carried out in a cooling mode, the 7 segment will be indicated as shown in right, and "Test operation" and "Under centralized control" will be displayed in the remote controller.
- During the check operation, it is impossible to stop the unit from the remote controller. When discontinue the operation, push confirmation button(BS3). The system will stop after behind operation for 30 seconds.
- It may takes 5 minutes to bring the state of refrigerant uniform before the compressor starts. Moreover, during the check operation, the refrigerant running sound, or the magnetic sound of a solenoid valve may become loud during operation, but these are not malfunctions.
- The abnormality of each indoor unit cannot be checked. After the check operation is finished, check the indoor units individually by normal operation using the remote controller.

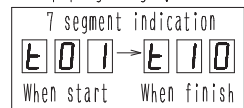

【Operation procedure】

- ① To protect the compressor, make sure to turn on the power supply for 6 hours before starting operation.
(After turning on the power supply, the unit can not start the operation until 7 segment goes off. (Maximum 12 minutes))
- ② In the state of unit stopped, set to Normal mode.
- ③ Push operation button (BS2) for 5 second or more. (Then the unit will start the check operation)
- ④ Close the front panel. (Otherwise, it may cause a wrong judgment.)
- ⑤ When the checks are completed (unit run for 30~40 min.), the system will stop automatically.
Check the operation results by the outdoor unit 7 segment display. (see the table shown below)

Result	7 Segment display
Normally finished	Light off
Abnormally finished	Malfunction code

! Push new page button (BS1) in case taking a wrong operation, then follow procedure since ② again.

【Measure when abnormally finished】

- ① Confirm the malfunction code by the remote controller and 7 segment display, and correct the abnormality. (For how to correct abnormality and correction method, see the installation manual, operation manual and service manual.)
- ② After correcting the abnormality, push confirmation button (BS3) and reset the malfunction code.
- ③ Carry out the check operation again and confirm that the abnormality is properly corrected.

Service mode operation method

- After turning on the power supply, the unit can not start until the 7 segment indication goes off for maximum 12 minutes.
- Do not turn off the power and do not reset the **Setting mode** when evacuating or recovering the refrigerant. (The expansion valves will close and the system can not be evacuated or recovered the refrigerant.)

[Evacuation method] (At the first installation this evacuation is not required, It is only required for service.)

- ① When the unit is in the state of unit stopped and under the **Setting mode**, set the **Ⓒ** refrigerant recovery/evacuation mode. (※)
- ② Evacuate the system with a vacuum pump.
- ③ Push confirmation button (BS3) after finish evacuation and reset the evacuation mode.
- ④ Push new page button (BS1) and reset **Setting mode**.

[Refrigerant recovery operation method] (Make sure to use a refrigerant reclaimer)

- ① In the state of unit stopped and under the **Setting mode**, set the **Ⓒ** refrigerant recovery/evacuation mode. (※)
- ② Recover the refrigerant by a refrigerant reclaimer. (For details, see the manual attached in refrigerant reclaimer.)
- ③ After completed, push confirmation button (BS3) and reset the refrigerant recovery mode.
- ④ Push new page button (BS1) and reset **Setting mode**.

(※) The expansion valves in the indoor and outdoor units will be opened completely, 7 segment display will be changed as shown in below and "Test operation" and "Under centralized control" will be displayed in the remote controller. The operation will be rejected.

7 Segment display **E 0 1**

R410A

For those who install or move the unit

1. When lifting the unit

- To hang the unit, use 2 slings of at least 27 ft. long. Put the belt slings into the product openings of foundation legs.
- Put cushioning plates of rags where the slings contact the casing in order to prevent the casing from being damaged.

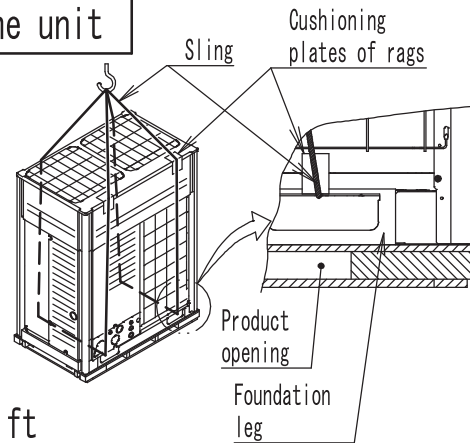

2. When carrying the unit by forklift

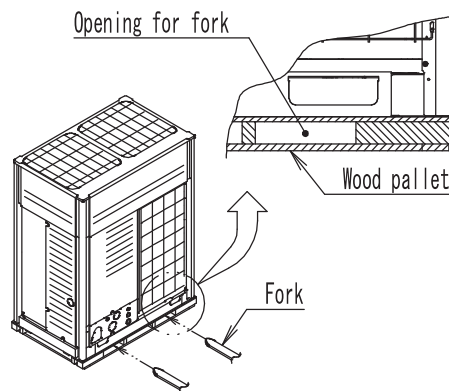

- If a forklift is used for carrying the unit, put the fork into wood pallet openings by let the tip out of the opposite side sufficiently.



3. Electrical work

- To prevent electric shock and fire accident, be sure to perform grounding and install an earth leak breaker.
- Electrical work must be carried out by a licensed electrician in accordance with local and national regulations.
- Confirm the insulation of main power supply circuit before opening the stop valve. If stop valve remains open without turn on the power supply, insulation resistance may decline due to refrigerant accumulating in compressor.

For those who carry out service and maintenance

	WARNING	<ul style="list-style-type: none"> • Beware of the fan rotating while inspection.
		Caution for electric shock

<Front panel (Middle) removing method>
 • Pull the front panel (middle) forward to take a hanging lug (bottom) off (①).
 Remove the panel downward (②).

<Front panel (Upper) removing method>
 • Lift up the panel a little and take a hanging lug off (①).
 Remove the panel forward (②).

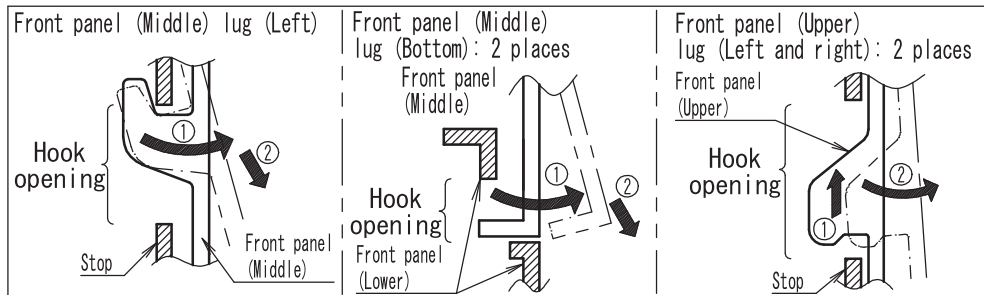
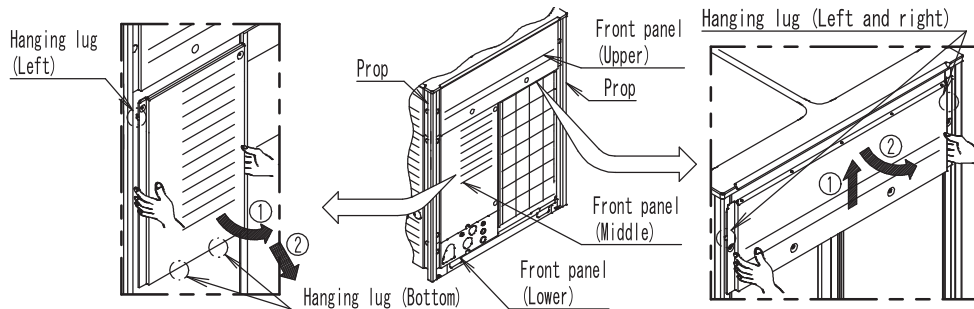

• For the location of the control box and the service parts, see below.

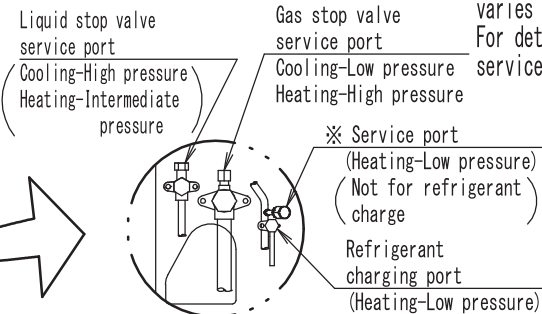
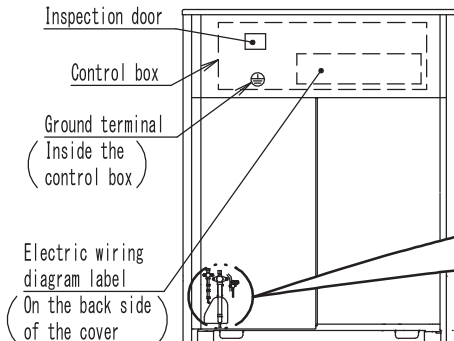

※ This service port varies by each models. For details refer to service manual.

※ Service port (Heating-Low pressure) (Not for refrigerant charge)
 Refrigerant charging port (Heating-Low pressure)

15. Caution for Refrigerant Leaks

15.1 Introduction

Points to note in connection with refrigerant leaks

The installer and system specialist shall secure safety against leakage according to local regulations or standards. The following standards may be applicable if local regulations are not available.

The VRV System, like other air conditioning systems, uses R410A as refrigerant. R410A itself is an entirely safe non-toxic, non-combustible refrigerant. Nevertheless care must be taken to ensure that air conditioning facilities are installed in a room which is sufficiently large. This assures that the maximum concentration level of refrigerant gas is not exceeded, in the unlikely event of major leak in the system and this in accordance to the local applicable regulations and standards.

Maximum concentration level

The maximum charge of refrigerant and the calculation of the maximum concentration of refrigerant is directly related to the humanly occupied space in to which it could leak.

The unit of measurement of the concentration is lb./1000 ft.³ (the weight in lbs. of the refrigerant gas in 1 ft.³ volume of the occupied space). Compliance to the local applicable regulations and standards for the maximum allowable concentration level is required.

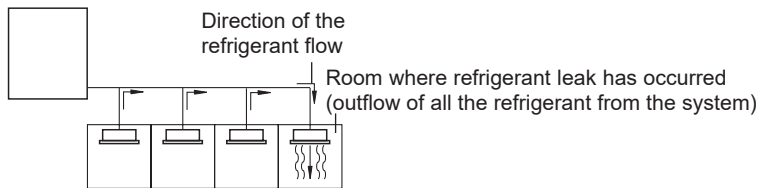

Pay special attention to places, such as basements, etc. where refrigerant can stay, since refrigerant is heavier than air.



15.2 Procedure for Checking Maximum Concentration

Check the maximum concentration level in accordance with steps 1 to 4 below and take whatever action is necessary to comply.

Step 1: Calculate the amount of refrigerant (lbs.) charged to each system separately.

$$\begin{array}{l} \text{Amount of refrigerant in a single unit} \\ \text{system (amount of refrigerant with} \\ \text{which the system is charged before} \\ \text{leaving the factory)} \end{array} + \begin{array}{l} \text{Additional charging amount (amount} \\ \text{of refrigerant added locally in} \\ \text{accordance with the length or diameter} \\ \text{of the refrigerant piping)} \end{array} = \begin{array}{l} \text{Total amount of refrigerant (lbs.)} \\ \text{in the system} \end{array}$$



Note:

Where a single refrigerant facility is divided into 2 entirely independent refrigerant systems then use the amount of refrigerant with which each separate system is charged.

Step 2: Calculate the smallest room volume (ft.³)

In case like the following, calculate the volume of (a), (b) as a single room or as the smallest room.

(a) Where there are no smaller room divisions.

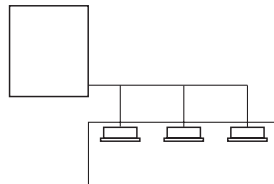

(b) Where there is a room division but there is an opening between the rooms sufficiently large to permit a free flow of air back and forth.

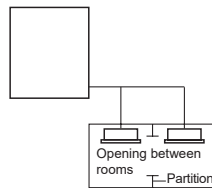

(Where there is an opening without a door or where there are openings above and below the door which are each equivalent in size to 0.15% or more of the floor area.)

(c) Where there is a gas leak detection alarm device linked to a mechanical ventilator in the smallest room then the next smallest room will become the measurement target.

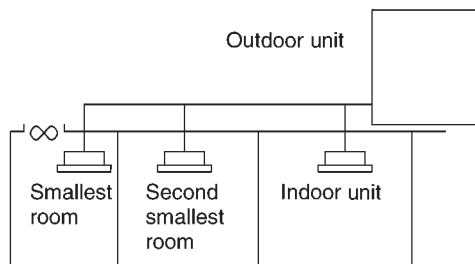

Step 3: Calculating the refrigerant density using the results of the calculations in steps 1 and 2 above.

$$\frac{\text{Total volume of refrigerant in the refrigerant system}}{\text{Size (ft.}^3\text{) of the smallest room in which there is an indoor unit installed}} \leq \text{Maximum concentration level (lbs./ft.}^3\text{)}$$

If the result of the above calculation exceeds the maximum concentration level then make similar calculations for the second then third smallest room and so until the result falls short of the maximum concentration.

Step 4: Dealing with the situations where the result exceeds the maximum concentration level.

Where the installation of a facility results in a concentration in excess of the maximum concentration level then it will be necessary to revise the system.
Please consult your Daikin supplier.

17. Safety Devices Setting

FXFQ-AA

Model		FXFQ07AAVJU	FXFQ09AAVJU	FXFQ12AAVJU	FXFQ15AAVJU	FXFQ18AAVJU
Printed circuit board fuse		250 V, 3.15 A	250 V, 3.15 A	250 V, 3.15 A	250 V, 3.15 A	250 V, 3.15 A
Fan motor thermal fuse	°C	—	—	—	—	—
Fan motor thermal protector	°C	—	—	—	—	—
Drain pump fuse	°C	—	—	—	—	—

Model		FXFQ24AAVJU	FXFQ30AAVJU	FXFQ36AAVJU	FXFQ48AAVJU	FXFQ54AAVJU
Printed circuit board fuse		250 V, 3.15 A	250 V, 3.15 A	250 V, 3.15 A	250 V, 3.15 A	250 V, 3.15 A
Fan motor thermal fuse	°C	—	—	—	—	—
Fan motor thermal protector	°C	—	—	—	—	—
Drain pump fuse	°C	—	—	—	—	—

C: 4D140940

FXZQ-TB

Model		FXZQ05TBVJU	FXZQ07TBVJU	FXZQ09TBVJU	FXZQ12TBVJU	FXZQ15TBVJU	FXZQ18TBVJU
Printed circuit board fuse		250 V, 3.15 A	250 V, 3.15 A	250 V, 3.15 A	250 V, 3.15 A	250 V, 3.15 A	250 V, 3.15 A
Fan motor thermal fuse	°F (°C)	—	—	—	—	—	—
Fan motor thermal protector	°F (°C)	—	—	—	—	—	—
Drain pump fuse	°F (°C)	—	—	—	—	—	—

C: 4D137360

FXUQ-PA

Model		FXUQ18PAVJU	FXUQ24PAVJU	FXUQ30PAVJU	FXUQ36PAVJU
Printed circuit board fuse		250 V, 3.15 A	250 V, 3.15 A	250 V, 3.15 A	250 V, 3.15 A
Drain pump thermal fuse	°F (°C)	—	—	—	—
Fan motor thermal protector	°F (°C)	—	—	—	—
Fan motor thermal fuse	°F (°C)	—	—	—	—

C: 3D133254

FXEQ-P

Model		FXEQ07PVJU	FXEQ09PVJU	FXEQ12PVJU	FXEQ15PVJU	FXEQ18PVJU	FXEQ24PVJU
Printed circuit board fuse	A1P	250 V, 3.15 A	250 V, 3.15 A	250 V, 3.15 A	250 V, 3.15 A	250 V, 3.15 A	250 V, 3.15 A
Fan motor thermal protector	°F (°C)	OFF: 223±9 (106±5) ON: 205±27 (96±15)	OFF: 223±9 (106±5) ON: 205±27 (96±15)	OFF: 223±9 (106±5) ON: 205±27 (96±15)	OFF: 223±9 (106±5) ON: 205±27 (96±15)	OFF: 223±9 (106±5) ON: 205±27 (96±15)	OFF: 223±9 (106±5) ON: 205±27 (96±15)

C: 4D098709

FXDQ-M

Model		FXDQ07MVJU	FXDQ09MVJU	FXDQ12MVJU	FXDQ18MVJU	FXDQ24MVJU
Printed circuit board fuse	A1P	250 V, 5 A	250 V, 5 A	250 V, 5 A	250 V, 5 A	250 V, 5 A
Fan motor thermal protector	°F	OFF: 266±9 ON: 181±27	OFF: 266±9 ON: 181±27	OFF: 266±9 ON: 181±27	OFF: 266±9 ON: 181±27	OFF: 266±9 ON: 181±27

C: 3D051758

FXSQ-TB

Model		FXSQ05TBVJU	FXSQ07TBVJU	FXSQ09TBVJU	FXSQ12TBVJU	FXSQ15TBVJU	FXSQ18TBVJU
Printed circuit board fuse		250 V, 3.15 A	250 V, 3.15 A	250 V, 3.15 A	250 V, 3.15 A	250 V, 3.15 A	250 V, 3.15 A
Printed circuit board fuse (fan driver)		250 V, 6.3 A	250 V, 6.3 A	250 V, 6.3 A	250 V, 6.3 A	250 V, 6.3 A	250 V, 6.3 A
Drain pump thermal fuse	°F (°C)	—	—	—	—	—	—

Model		FXSQ24TBVJU	FXSQ30TBVJU	FXSQ36TBVJU	FXSQ48TBVJU	FXSQ54TBVJU
Printed circuit board fuse		250 V, 3.15 A	250 V, 3.15 A	250 V, 3.15 A	250 V, 3.15 A	250 V, 3.15 A
Printed circuit board fuse (fan driver)		250 V, 6.3 A	250 V, 6.3 A	250 V, 6.3 A	250 V, 6.3 A	250 V, 6.3 A
Drain pump thermal fuse	°F (°C)	—	—	—	—	—

C: 3D140708

FXMQ-TB

Model		FXMQ15TBVJU	FXMQ18TBVJU	FXMQ24TBVJU	FXMQ30TBVJU
Printed circuit board fuse		250 V, 3.15 A	250 V, 3.15 A	250 V, 3.15 A	250 V, 3.15 A
Printed circuit board fuse (fan driver)		250 V, 6.3 A	250 V, 6.3 A	250 V, 6.3 A	250 V, 6.3 A
Drain pump thermal fuse	°F (°C)	—	—	—	—

Model		FXMQ36TBVJU	FXMQ48TBVJU	FXMQ54TBVJU
Printed circuit board fuse		250 V, 3.15 A	250 V, 3.15 A	250 V, 3.15 A
Printed circuit board fuse (fan driver)		250 V, 6.3 A	250 V, 6.3 A	250 V, 6.3 A
Drain pump thermal fuse	°F (°C)	—	—	—

C: 3D140811

FXMQ-TA

Model		FXMQ72TAVJU	FXMQ96TAVJU
Printed circuit board fuse		250 V, 5 A	250 V, 5 A
Fan motor thermal fuse	°F	—	—
Fan motor thermal protector	°F	OFF: 275±14 (ON: 189±27)	OFF: 275±14 (ON: 189±27)

FXHQ-M

Model		FXHQ12MVJU	FXHQ24MVJU	FXHQ36MVJU
Printed circuit board fuse		250 V, 5 A	250 V, 5 A	250 V, 5 A
Fan motor thermal fuse	°F	–	–	–
Fan motor thermal protector	°F	OFF: 266±9 ON: 176±36	OFF: 266±9 ON: 176±36	OFF: 266±9 ON: 176±36

C: 3D049334A

FXAQ-P

Model		FXAQ07PVJU	FXAQ09PVJU	FXAQ12PVJU	FXAQ18PVJU	FXAQ24PVJU
Printed circuit board fuse		250 V, 3.15 A	250 V, 3.15 A	250 V, 3.15 A	250 V, 3.15 A	250 V, 3.15 A
Fan motor thermal fuse	°F	–	–	–	–	–
Fan motor thermal protector	°F	–	–	–	–	–

C: 4D047085D

FXLQ-M, FXNQ-M

Model		FXLQ07MVJU FXNQ07MVJU	FXLQ09MVJU FXNQ09MVJU	FXLQ12MVJU FXNQ12MVJU	FXLQ18MVJU FXNQ18MVJU	FXLQ24MVJU FXNQ24MVJU
Printed circuit board fuse		250 V, 5 A	250 V, 5 A	250 V, 5 A	250 V, 5 A	250 V, 5 A
Fan motor thermal protector	°F (°C)	OFF: 275±18 (135±10) ON: 248 (120) or less	OFF: 275±18 (135±10) ON: 248 (120) or less	OFF: 275±18 (135±10) ON: 248 (120) or less	OFF: 275±18 (135±10) ON: 248 (120) or less	OFF: 275±18 (135±10) ON: 248 (120) or less

C: 3D045646B

FXTQ-TB

Model	FXTQ09TBVJUA	FXTQ12TBVJUA	FXTQ18TBVJUA	FXTQ24TBVJUA	FXTQ30TBVJUA
Model (with factory disconnect)	FXTQ09TBVJUD	FXTQ12TBVJUD	FXTQ18TBVJUD	FXTQ24TBVJUD	FXTQ30TBVJUD
Printed circuit board fuse (F1U)	32 V, 3 A	32 V, 3 A	32 V, 3 A	32 V, 3 A	32 V, 3 A
Printed circuit board fuse (F2U)	250 V, 3.15 A	250 V, 3.15 A	250 V, 3.15 A	250 V, 3.15 A	250 V, 3.15 A
Others	Blower motor, Fan driver overload protector				

Model	FXTQ36TBVJUA	FXTQ42TBVJUA	FXTQ48TBVJUA	FXTQ54TBVJUA	FXTQ60TBVJUA
Model (with factory disconnect)	FXTQ36TBVJUD	FXTQ42TBVJUD	FXTQ48TBVJUD	FXTQ54TBVJUD	FXTQ60TBVJUD
Printed circuit board fuse (F1U)	32 V, 3 A	32 V, 3 A	32 V, 3 A	32 V, 3 A	32 V, 3 A
Printed circuit board fuse (F2U)	250 V, 3.15 A	250 V, 3.15 A	250 V, 3.15 A	250 V, 3.15 A	250 V, 3.15 A
Others	Blower motor, Fan driver overload protector				

CXTQ-TA

Model	CXTQ24TASBLU	CXTQ36TASBLU	CXTQ48TASBLU	CXTQ60TASBLU
Printed circuit board fuse (F1U)	32 V, 3 A	32 V, 3 A	32 V, 3 A	32 V, 3 A
Printed circuit board fuse (F2U)	250 V, 3.15 A	250 V, 3.15 A	250 V, 3.15 A	250 V, 3.15 A

4. Appendix

1. Introduction

1.1 ED Book List

Design Manual RXLQ-TB **EDUS342353-D**
(This booklet)

Capacity Table Book..... RXLQ-TB **EDUS342353-C**

Indoor Units

Ceiling Mounted Cassette Type (Round Flow with Sensing) ... FXFQ-AA **EDUS392234-F14**

VISTA™ 2 × 2 Cassette Unit FXZQ-TB **EDUS392209-F9**

4-Way Blow Ceiling-Suspended Type..... FXUQ-PA **EDUS392109-F15**

One Way Blow Cassette Type FXEQ-P **EDUS391533A-F16**

Slim Ceiling Mounted Duct Type FXDQ-M **EDUS39-600B-F2**

MSP Concealed Duct Unit FXSQ-TB **EDUS392235-F17**

HSP Concealed Ducted Unit FXMQ-TB **EDUS392236-F4**

Ceiling Mounted Duct Type FXMQ-TA **ED5VRV2S-NA23V1**

Ceiling Suspended Type..... FXHQ-M **EDUS39-600A-F5**

Wall Mounted Type..... FXAQ-P **EDUS391100A-F6**

Floor Standing Type / Concealed Floor Standing Type FXLQ-M
FXNQ-M **EDUS391502A-F7**

Air Handling Unit..... FXTQ-TB ... **Engineering Data FXTQ-TB**

Cased Coil Unit CXTQ-TA ... **Engineering Data CXTQ-TA**

Branch Selector Unit BSQ-T
BSF-Q54T
BS-Q54T **EDUS392110-B**

Air Treatment Equipment

Outdoor Air Processing Unit FXMQ-MF **EDUS39-900B-F10**

Energy Recovery Ventilator..... VAM-G **EDUS711116B**

Controls..... **EDUS721909A-T**

Remote Controller

Navigation Remote Controller..... BRC1E73 **EDUS721438**

4. Appendix

1.2 Publication List of Engineering Data for VRV Products

Shaded sections indicate Engineering Data Book/s published for this series.

Timing of publication is subject to change without notice.

Outdoor Unit

Refrigerant	Category	Product series	Type	Volts	Model name	Area	Book category	Book No.	Published in	
R410A	Air cooled	VRV EMERION	H/R	208/230 V 460 V	REYQ-AATJB, AAYDB	USA Canada	Design manual	EDUS372348-D	Feb.2024	
							Capacity table	EDUS372348-C	Mar.2024	
			H/P	208/230 V 460 V	RXYQ-AATJB, AAYDB	USA Canada	Design manual	EDUS342395-D	Feb.2024	
						Capacity table	EDUS342395-C	Mar.2024		
			VRV IV-X	H/R	208/230 V 460 V 575 V	REYQ-XBTJA, XBYDA, XBYCA	USA Canada	Design manual	EDUS372349-D	Mar.2024
							Capacity table	EDUS372349-C	Mar.2024	
				H/P	208/230 V 460 V	RXYQ-XATJA, XAYDA	USA Canada	Design manual	EDUS341923A-D	Oct.2020
					575 V	RXYQ-XBYCA	Canada	Capacity table	EDUS341923-C	Nov.2019
								Design manual	EDUS342391-D	Mar.2024
								Capacity table	EDUS342391-C	
			VRV IV	H/R	208/230 V 460 V	REYQ-TATJA, TAYDA	USA Canada	Design manual	EDUS371704C-D	Feb.2020
					575 V	REYQ-TAYCA	Canada	Capacity table	EDUS371704C-C	
								Design manual	EDUS371706C-D	
								Capacity table	EDUS371706C-C	
				H/P	208/230 V 460 V	RXYQ-TATJA, TAYDA	USA Canada	Design manual	EDUS341703B-D	Jan.2020
					575 V	RXYQ-TAYCA	Canada	Capacity table	EDUS341703B-C	
							Design manual	EDUS341824A-D		
							Capacity table	EDUS341824A-C		
			VRV Aurora	H/R	208/230 V 460 V 575 V	RELQ-TBTJA, TBYDA, TBYCA	USA Canada	Design manual	EDUS372352-D	Mar.2024
								Capacity table	EDUS372352-C	
			H/P	208/230 V 460 V 575 V	RXLQ-TBTJA, TBYDA, TBYCA	USA Canada	Design manual	EDUS342353-D	Mar.2024	
							Capacity table	EDUS342353-C		
		VRV IV-S	H/P	208/230 V	RXTQ36TAVJ9A RXTQ48/60TAVJUA	USA Canada	Design manual	EDUS331608C-D	Feb.2020	
							Capacity table	EDUS331608C-C		
	VRV LIFE	H/P	208/230 V	RXSQ-TAVJUA	USA Canada	Design manual	EDUS331721A-D	Feb.2020		
						Capacity table	EDUS331721A-C			
	Installation for all VRV air cooled type						Installation	EDUS371848-N	Aug.2019	
	Water cooled	VRV-W	H/P	208/230 V 460 V	RWEQ-TBTJA, TBYDA, TBYCU	USA Canada	Design manual	EDUS302354-D	Mar.2024	
				H/R			575 V	Capacity table		EDUS302354-C
	Installation for all VRV water cooled type						Installation	EDUS301864-N	Aug.2019	

Note:

C/O: Cooling only, H/P: Heat pump, H/R: Heat recovery

Indoor Unit and Other Products

Refrigerant	Product category	Product type	Model name	Area	Book No.	Published in	
R410A	VRV Indoor units	Ceiling Mounted Cassette Type (Round Flow with Sensing)	FXFQ07-54AAVJU	USA	EDUS392234-F14	Oct.2023	
		VISTA™ 2 x 2 Cassette Unit	FXZQ05-18TBVJU	USA	EDUS392209-F9	Feb.2022	
		4-Way Blow Ceiling- Suspended Type	FXUQ18-36PAVJU	USA	EDUS392109-F15	Jul.2021	
		One Way Blow Cassette Type	FXEQ07-24PVJU	USA	EDUS391533A-F16	Jan.2021	
		Slim Ceiling Mounted Duct Type	FXDQ07-24MVJU	USA	EDUS39-600A-F2	Mar.2021	
		MSP Concealed Ducted Unit	FXSQ05-54TBVJU	USA	EDUS392235-F17	Oct.2022	
		HSP Concealed Ducted Unit	FXMQ15-54TBVJU	USA	EDUS392236-F4	Oct.2022	
		Ceiling Mounted Duct Type	FXMQ72/96TAVJU	USA	ED5VRV2S-NA23V1	Sep.2023	
		Ceiling Suspended Type	FXHQ12-36MVJU	USA	EDUS39-600A-F5	Mar.2021	
		Wall Mounted Type	FXAQ07-24PVJU	USA	EDUS391100A-F6	Jan.2021	
		Floor Standing Type Concealed Floor Standing Type	FXLQ07-24MVJU FXNQ07-24MVJU	USA	EDUS391502A-F7	Jan.2021	
		Low-temperature hydrobox	HXY48TAVJU	USA	EDUS392021-F18	Sep.2020	
		AHU Integration Kit—Re-Heat	EKEQDCBAV3-US	USA	EDUS392125-F19	Mar.2022	
		Cased Coil Unit	CXTQ24-60TASBLU	USA	Engineering Data CXTQ-TA	—	
		Air Handling Unit	FXTQ09-60TBVJUA FXTQ09-60TBVJUD	USA	Engineering Data FXTQ-TB	—	
		Outdoor Air Processing Unit	FXMQ48-96MFVJU	USA	EDUS39-900B-F10	Mar.2021	
		Branch Selector Unit	BSQ-TAVJ BSF-Q54TVJ BS-Q54TAVJ	USA	EDUS392110-B	Jun.2021	
		Controls and networks	Control systems Control devices Adaptors	Please refer to ED Book with No. on the right for applicable models.	USA	EDUS721909A-T	Oct.2020
	Navigation remote controller		BRC1E73	USA	EDUS721438	Apr.2015	
	intelligent Touch Manager		DCM601A71, DCM601A72	USA	EDUS721212A	Mar.2022	
	intelligent Touch Controller		DCS601C71	USA	EDUS72-608	Dec.2006	
	Interface for use in BACnet®		DMS502B71	USA	EDUS72-749	Oct.2007	
	Option for all type			Please refer to ED Book with No. on the right for applicable models.	USA	OHUS07-1	Nov.2007
	Energy Recovery Ventilator (VAM)			VAM300-1200GVJU	USA	EDUS711116B	Dec.2020

MEMO

Warning



- Ask a qualified installer or contractor to install this product. Do not try to install the product yourself. Improper installation can result in water or refrigerant leakage, electrical shock, fire or explosion.
- Use only those parts and accessories supplied or specified by Daikin. Ask a qualified installer or contractor to install those parts and accessories. Use of unauthorised parts and accessories or improper installation of parts and accessories can result in water or refrigerant leakage, electrical shock, fire or explosion.
- Read the user's manual carefully before using this product. The user's manual provides important safety instructions and warnings. Be sure to follow these instructions and warnings.

If you have any enquiries, please contact your local importer, distributor and/or retailer.

Cautions on product corrosion

1. Air conditioners should not be installed in areas where corrosive gases, such as acid gas or alkaline gas, are produced.
2. If the outdoor unit is to be installed close to the sea shore, direct exposure to the sea breeze should be avoided. If you need to install the outdoor unit close to the sea shore, contact your local distributor.